

# Carbide End Mills

High Precision & High Speed Cutting  
Wide range of products

# 18,619

Your specials are our standards. 당신의 스페셜은 우리의 표준품입니다.





**HARD series**  
고이송용 엔드밀 시리즈  
High Speed EndMills Series

**CBN series**  
CBN 엔드밀 시리즈  
CBN EndMills Series

**JJ series**  
고경도용 엔드밀 시리즈  
EndMills for Hardened Steel

**HARD series**  
고속가공용 엔드밀 시리즈  
High Speed EndMills Series

**E series**  
강력절삭 엔드밀 시리즈  
EndMills for Heavy Cuts

**G series**  
범용 엔드밀 시리즈  
EndMills for General purpose

**FOR SUS & TITANIUM**  
SUS, 티타늄 가공용 엔드밀 시리즈  
EndMills for SUS & Inconel

**V series**  
고능률 범용 엔드밀  
Various Symmetry EndMills



**FOR GRAPHITE**  
 흑연가공용 엔드밀 시리즈  
 EndMills for Graphite



**R-TAC**  
 R-TAC 코팅 엔드밀 시리즈  
 R-TAC Coated EndMills Series



**FOR COMPOSITE**  
 복합소재 가공용 엔드밀 시리즈  
 EndMills for Composite



**FOR ALUMINUM**  
 알루미늄 가공용 엔드밀 시리즈  
 EndMills for Aluminum

**Globally exporting the Outstanding quality**

세계로 수출하는 명품 엔드밀

**JJTOOLS**

지속적인 신제품 개발과 품질 향상으로 고객의 믿음을 이어가겠습니다.

We are doing our best for customers' productivity improvement via continual efforts for quality innovation and applying the newly qualified technology to the products.



**Drills**  
 드릴 시리즈



**Inserts**  
 인서트 시리즈



**PCD series**  
 PCD 엔드밀 시리즈



**Thread Mills**  
 쓰레드밀 시리즈



# The Latest Manufacturing Equipment !

## New Precision Tolerance !

최신의 초정밀 장비 !  
한차원 높은 정밀 공차 !

JJ TOOLS achieved a big quality improvement on its' standard products line by applying very tight tolerance control as well as the world best class manufacturing equipments with very well qualified engineers.

제이제이툴스는 초정밀 공구생산을 위한 세계 최고 수준의 첨단 설비와 우수한 전문 인력을 기반으로 더욱 혁신적인 정밀공차 관리를 함으로써 표준 엔드밀의 제품 수준을 대폭 향상 시켰습니다.



<b>Tolerance</b> <b>공구 오차</b> <b>(2PHCB)</b>	$0.1R \leq R \leq 1R$	$\pm 0.003mm$
	$1R < R \leq 3R$	$\pm 0.005mm$
	$3R < R$	$\pm 0.008mm$





**Various product line up !**

**18,619 tools in 278 item !**

**278품목 18,619개의 다양한 제품 라인업 !**

JJ TOOLS is managing the huge inventories as much as 18,619 products products from CBN to multi purpose WC endmills for customer satisfaction not only for quality but on time delivery. And we have been introducing new products by continual R&D and investment. Excellent quality and dimensional accuracy, outstanding tool life - the passion of JJ TOOLS for delivering the best quality cutting tools to the market will be continued.

**Your specials are our standards.**

CBN 엔드밀부터 범용 엔드밀까지 18,619개의 다양한 제품규격을 보유하고 있으며, 지속적인 연구개발 및 투자를 통하여 우수한 제품을 속속 선보이고 있습니다. 탁월한 절삭력 및 치수 정밀도, 오래가는 공구수명- 앞으로는 최고의 절삭공구를 만들기 위한 제이제이툴스의 열정은 끊임없이 계속됩니다.

**당신의 스페셜은 우리의 표준품입니다.**



HRC 52~68

## JJ series for hardened steels

### 고경도재 가공용 JJ 시리즈

Endmills for pre-hardened and hardened steels(HRC52~68)

고경도강(HRC52~68), 프리하든강 계열의 고정밀가공 엔드밀

- Good wear resistance by high quality Si-based PVD coating.
- High precise edge tolerance.
- Very nice work surface finish.
- Outstanding performance at high speed machining by ultra fine(0.2 $\mu$ m) WC grade.
- 고품질 실리콘계 코팅 (Si) 처리하여 내마모성이 우수합니다.
- 고정밀 공차 적용으로 초정밀 가공에 적합합니다.
- 날부인선의 조도가 뛰어나 피삭재의 면조도가 우수합니다.
- 초미립자 초경합금 (0.2 $\mu$ m)을 채택, 고속절삭시 뛰어난 성능을 발휘합니다.



### JJTOOLS's solution

다양한 피삭재를 위한

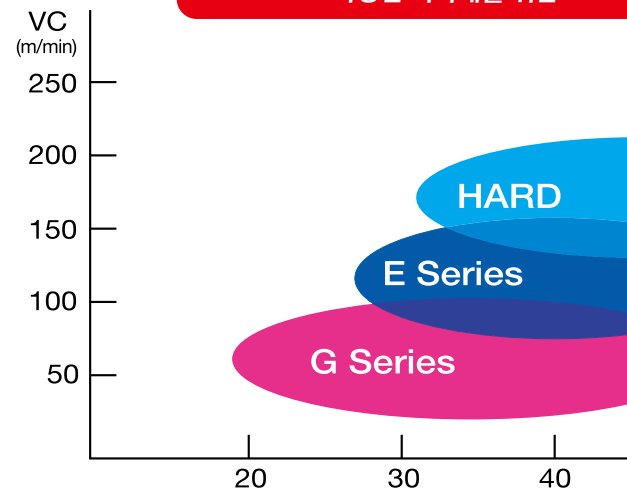

HRC 50~65

## HARD series for high speed cutting

### 고속가공용 HARD 시리즈

Endmills for pre-hardened and hardened steels (HRC50~65)

고경도강 (HRC50~65), 프리하든강 계열의 고정밀가공 엔드밀

- Good wear resistance by high quality Si-based PVD coating.
- High precise edge tolerance.
- Very nice work surface finish.
- Outstanding performance at high speed machining by ultra fine(0.2 $\mu$ m) WC grade.
- 고품질 실리콘계 코팅 (Si) 처리하여 내마모성이 우수합니다.
- 고정밀 공차 적용으로 초정밀 가공에 적합합니다.
- 날부인선의 조도가 뛰어나 피삭재의 면조도가 우수합니다.
- 초미립자 초경합금 (0.2 $\mu$ m)을 채택, 고속 절삭 시 뛰어난 성능을 발휘합니다.

HRC ~52

## E series for heavy cuts

### 강력절삭용 E 시리즈

Endmills for various work materials (~HRC52), pre-hardened steels, carbon steels, mold steels.

중저경도강 (HRC52이하), 프리하든강계열, 탄소강, 금형강등

- Good wear resistance by high quality Si-based PVD coating.
- Suitable shape is designed for tooling in wide areas.
- Maximize the manufacturing cost saving with low price of products.
- Minimize fracturing by high TRS fine (0.5 $\mu$ m) WC grade.
- 고함량 실리콘계 코팅 (Si) 처리하여 내마모성이 우수합니다.
- 넓은 영역의 피삭재 가공에 적합한 형상으로 설계 하였습니다.
- 경제적인 가격으로 가공 생산비 절감을 극대화합니다.
- 항절삭력이 높은 미립자 초경합금 (0.5 $\mu$ m)을 채택, 엔드밀의 파손을 최소화 하였습니다.

for various work materials

JJTOOLS(주)의 솔루션

JJ Series

Series

50

60

65~

HRC

HRC ~52

## G series for general purpose

### 다양한 피삭가공, 범용 G 시리즈

Endmills for various work materials (~HRC52), pre-hardened steels, carbon steels, mold steels.

중저경도강 (HRC52이하), 프리하든강계열, 탄소강, 금형강등

- Optimum for various work materials by JCRO coating.
- High precise edge tolerance.
- Minimize fracturing by high TRS fine (0.5 $\mu$ m) WC grade.
- JCRO 코팅 처리하여 넓은 영역의 피삭재 가공에 적합합니다.
- 고정밀 공차 적용으로 초정밀 가공에 적합합니다.
- 항절삭력이 높은 미립자 초경합금 (0.5 $\mu$ m)을 채택, 엔드밀의 파손을 최소화 하였습니다.



**Optimized for precise machining of high hardness work material**

고경도재의 정밀 정삭가공에 적합한

**High Abrasion Resistance !**

**탁월한 내마모 품질!**



**CBN series**

**CBN EndMills series**

**CBN 엔드밀 시리즈**

**Optimized mirror face machining for hardened steels (HRc72) !**

**HRc72 고경도강의 경면 사상 가공에 최적 !**

- PCBN Endmills for precise finishing ( $\pm 5\mu\text{m}$ ) of hardened steels(HRc52~72)
- Long tool life by high quality PCBN

CBN 시리즈는 고함량의 PCBN을 사용하여 탁월한 내마모성과 최적의 인선부 설계로 뛰어난 절삭력 및 경면 조도를 나타내며, 고경도강(HRc72)의 고속 가공시 최고의 성능을 발휘합니다.

**Various helix design for the best quality !**

다양한 인선형상 설계로 최상의 맞춤품질 확보!



**Helix 30°**

Optimum for hardened - mold machining  
열처리 금형가공에 최적



**Helix 0°**

Optimum for mirror face machining  
경면 사상가공에 최적



# High speed machining hardened steels

고경도재 고속가공의

# Super EndMills !

절대 강자 !

**More than 2 times performance than corner Insert end mills !**

2배이상의 성능 실현!

경도 HRC65이하 소재의황삭, 중삭가공시

**Guarantee more than 6 times Re-grinding !**

코너R 마모시 6회 이상의 재연삭 가능!

The best of high speed cutting  
고속 · 고이송 가공에 최적화된  
**Corner Radius Cutters**

코너 레디우스커터

## High SPEED Cutters

고이송 커터

**Dramatically decreased cutting stress**

절삭 부하를 획기적으로 감소시킨

**JJ Double Corner Radius Cutters**

더블 코너 레디우스 커터

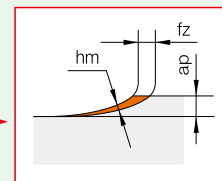
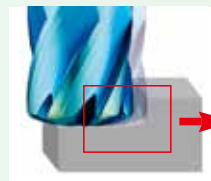

Thinner removal chip  
더 얇게 제거되는 칩

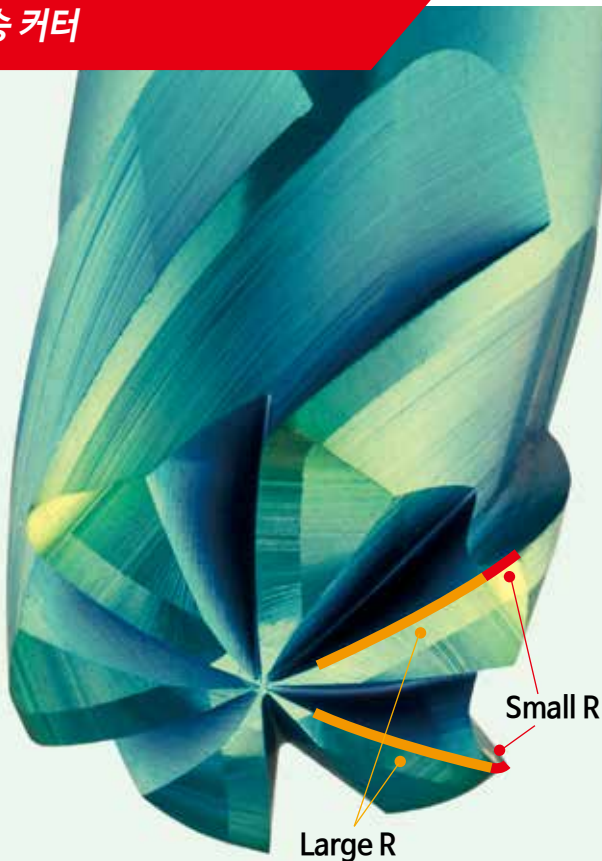

- Double radius design on the endface makes thinner chip removal and reduce cutting stress than conventional corner radius End mills.
- The maximum cutting depth is up to the end of the large R, and the large R minimizes vibration, enabling stable milling.
- 바닥면의 인선을 더블R로 설계하여 기존 코너R 엔드밀에 비해 공작물 가공시 절삭칩이 얇게 배출되어 절삭 부하를 줄여줍니다.
- 최대 절삭깊이  $ap$ 는 큰 반경R이 끝나는 인선부까지 이며, 고이송 절삭시 큰 반경R은 떨림을 최소화하여 안정적 가공을 가능하게 합니다.

**6JJDRC**

# V SERIES

## Strong design for protection against chattering !

진동을 최소화 및 강력한 채터링 방지 !

### Unequal pitch design !

부등분할 날부 설계 !

Minimized noise and vibration due to unequal pitch design of bottom flute.

부등분할 밑날 적용으로 절삭 시 소음 및 진동을 최소화 하였습니다.

### Improved flute design for better tool life !

긴 공구 수명을 위한 향상된 코너 설계 !

With shield edge design, breakage of flute end is avoided.

실드 엠티지를 채택하여 엔드밀 끝날의 급각 파손을 방지 하였습니다.

### Multiple Helix

부등리드

The unequal lead design enables optimal chip evacuation and faster and more powerful cutting.

부등리드 설계로 최적의 칩 배출이 가능하며 더 빠르고 강력한 절삭이 가능합니다.

### Wide chip pocket for excellent chip emission

칩 배출이 용이한 넓은 칩 포켓 !

Cutting chips are well evacuated.

절삭 칩이 원활하게 배출 됩니다.

### Applied new coating !

새로운 HR 코팅을 적용 !

HR coating restrained built-up edge to enhance wear resistance of V series

HR 코팅을 적용하여 내마모성을 높였으며, 엔드밀 인선부의 구성인선 (built-up edge)을 억제하여 초기 엔드밀 마모를 대폭 개선하였습니다.

**NEW**





## High speed slotting End mills for dynamic roughing milling !

황삭 다이내믹 가공을 위한

### High Speed Slotting End Mills

고속 슬로팅 가공 엔드밀

**4SLE**

- Endmills for finishing and roughing of alloy steel, sus, inconel, mild steels and various hard to cut materials.
- Chip emission is excellent for slotting, and thick double core designed enables continuous machining without chattering.
- HR coating provides wear resistance improvement as well as avoid edge stress in various applications.
- 합금강, SUS계열, 인코넬, 일반구조강 등 다양한 난삭재 정삭, 황삭 가공
- 슬로팅 가공시 2중의 옆날 홈으로 칩 배출이 우수하며, 두터운 2중의 코어는 흔들림 없는 가공을 구현합니다.
- HR 코팅 처리하여 다양한 피삭재 가공시 인선부에 스트레스가 적으며, 내마모성 또한 향상됩니다.



## For high speed roughing milling

고속 황삭 가공을 위한

### Trochoidal Milling End Mills

트로코이달 가공 엔드밀

**5&6TROE**

Trochoidal milling is a high-efficiency milling method that utilizes low radial depth of cut and high axial depth of cut for high-speed machining. It involves having a spiral toolpath to control the radial contact area during machining and maintain a consistent chip thickness. This is a characteristic feature of trochoidal milling.

트로코이달 밀링은 고효율 밀링의 한 방법으로서 낮은 반경 방향 절삭깊이와 높은 축방향 절삭깊이를 사용한 고속가공법입니다. 가공시 반경방향 접촉면적을 적절히 컨트롤하면서 칩 두께를 일정하게 유지하는 것이 특징으로 이를 위해 공구경로가 나선형을 가지게 됩니다.

Conventional milling 기존 슬로팅 가공 Trochoidal slotting 트로코이달 슬로팅 가공

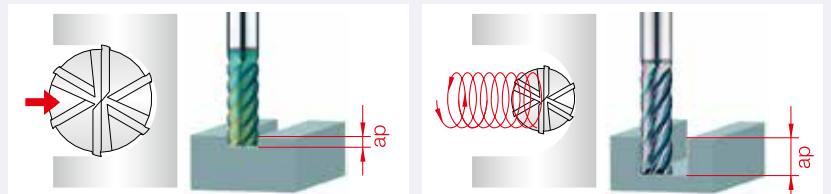

Optimized chip breaker for deep milling  
깊은 가공에 최적화된 칩브레이커

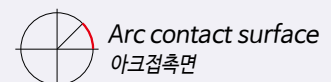
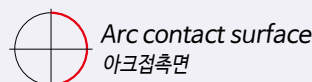

Optimized End Mills Series for High-Speed,  
High-Feed Semi-Finishing, Roughing Aluminum Machining

# Aluminum series **NEW**

고이송 중삭, 황삭의 최적화 된 알루미늄 전용 엔드밀 시리즈

**Adopted Special Edge Design for  
Maximizing Effective Chip Evacuation !**

**특별한 날 부 디자인을 채택, 효과적인 칩 배출 극대화함 !**



Optimal for High-Speed Machining !  
Excellent 4-Flute Design for Superior Sidewall Machining !  
Applying sharp edges and contoured flute design to minimize  
machining load !

고이송 가공의 최적! 측벽가공의 탁월한 4날 플루트 적용 !  
샤프한 인선과 경면의 플루트 형상을 적용하여 가공 부하를 최소화 !

Implemented Chip Breaker Type !  
Maximized Efficient Chip Fragmentation !  
Applied R-TAC Coating with High Hardness and Thin Thickness  
to Maintain Sharp Edge and Prolong Tool Life !

칩 브레이크 타입을 적용! 효과적인 칩의 분쇄를 극대화 !  
R-TAC 코팅을 적용하여 샤프한 엿지를 유지하고 공구의 수명을 증가 !

# Ultra fine surface after machining

탁월한 피삭재의 경면조도 !

**R-TAC**

## 코팅피막이 우수한 Tetrabond TAC Tetrabond TAC Coated End Mills

### R-TAC 코팅 엔드밀

End Mills for Aluminum, Aluminum alloys, copper, copper alloys, CFRP, GFRP, glass/carbon fiber, non-ferrous and non-metallic materials.

알루미늄 및 알루미늄 합금, 동 및 동합금, 강화플라스틱 (CFRP, GFRP), 유리/탄소섬유 등 비철, 비금속 피삭재 전용

- Tetrabond TAC coating provides excellent work surface finish by high hardness and low friction.
- High precise edge tolerance.
- Minimize fracturing by high TRS fine (0.5 $\mu$ m) WC grade.
- 코팅피막에 경도가 높고 마찰계수가 낮은 SUPER TAC코팅을 적용해 내마모성이 우수하며, 피삭재 표면조도가 월등히 우수함
- 고정밀 공차 적용으로 초정밀가공에 적합
- 항절력이 높은 미립자 초경합금 (0.5 $\mu$ m)을 채택, 엔드밀의 파손을 최소화하였습니다.



# Applied RTAC coating for excellent surface finish !

R-TAC코팅을 통한 업그레이드로 인선부의 고풍면 구현!

## End Mills for Aluminum

**FOR ALUminum**

### AL가공용 엔드밀

Endmills for Aluminum, AL alloys, non-ferrous and non-metallic materials.

알루미늄 및 알루미늄 합금 등 비철, 비금속 피삭재 전용

- Applied fine WC grade for excellent surface finish.
- With RTAC coating, the tool life improved more than two times over conventional uncoated endmills.
- Various flute length design for covering wide range application.
- Minimize built up edge by double edge and deep pocket design.
- Minimize fracturing by high TRS fine (0.5 $\mu$ m) WC grade.
- 날부 인선을 고풍면 설계하여 절삭시 피삭재의 표면조도가 우수합니다.
- RTAC코팅 처리하여, 기존 비코팅 엔드밀 대비 2배이상 공구수명이 증가하였습니다.
- 다양한 날장(S, L, Exl, Etc)선택으로 맞춤 가공이 가능합니다.
- 2중 인선과 홈포켓의 깊게 설계로 흡착현상을 최소화 하였습니다.
- 미립자 초경합금 (0.5 $\mu$ m)을 채택, 엔드밀의 파손을 최소화 하였습니다.



# Strong design for protection against chattering !

강력한 채터링 방지 설계로 진동을 최소화 !

**FOR SUS** Excellent Chip Control  
칩배출이 뛰어난

## End Mills for SUS

SUS 가공용 엔드밀

End Mills for alloy steels, SUS, Ti/Ni base alloys, Inconel and hard to cut materials.

SUS계열, Ti/Ni계합금, 인코넬, 합금강 등 난삭재 전용

- 강력한 채터링방지 설계로 엔드밀의 진동을 최소화 하였습니다.
- 깊은 포켓으로 칩배출이 원활하며 피삭재 면조도가 우수
- 42° 헬릭스 형상으로 설계하여 고속, 고이송 가공에 최적
- 항절력이 높은 미립자 초경합금을 채택하여 고이송 작업시 엔드밀의 파손을 최소화 하였습니다.
- Strong design for protection against chattering.
- Excellent work surface finish by deep chip pocket.
- 42° degree helix design for high speed, feed condition.
- Minimize fracturing at high feed by high TRS fine WC grade.

# Applying multi flutes to Minimize damage on edge !

다날 구조 채택으로 인선부 파손 최소화 !

**FOR Titanium**

## End Mills for TITANIUM

TITANIUM 가공용 엔드밀

End Mills for alloy steels, SUS, Ti/Ni base alloys, Inconel and hard to cut materials.

티타늄, Ti/Ni계합금, 인코넬, 합금강, SUS계열 등 난삭재 전용

- HR coating provides wear resistance improvement as well as avoid edge stress in various applications.
- Strong design for protection against chattering..
- Minimize fracturing at high feed by high TRS fine WC grade.
- HR 코팅 처리하여 다양한 피삭재 가공시 인선부에 스트레스가 적으며, 내마모성 또한 향상됩니다.
- 강력한 채터링방지 설계로 엔드밀의 진동을 최소화 하였습니다.
- 항절력이 높은 미립자 초경합금을 채택하여, 고이송 작업시 엔드밀의 파손을 최소화 하였습니다.

**230°, 270° degree ball shape**

230, 270도의 인선으로

**Optimized for wide range 3D machining**

광범위한 3D가공에 최적!

**HARD series**

## Spherical End Mills for 3D Machining

3D가공용 구형엔드밀

고경도강(HRc50~65), 프리하든강 계열의 고정밀가공

Endmills for pre-hardened and hardened steels(HRc50~65)

- 230°, 270° degree ball shape for wide range 3D machining.
- Minimize chattering and fracturing by taper and straight designed flute.
- Outstanding performance at high speed machining by ultra fine (0.2 $\mu$ m) WC grade.
- 230, 270도 구형의 인선으로 광범위한 3D 가공에 적합
- 유효장을 직선 및 테이퍼 설계하여 목부파손 및 떨림을 최소화
- 초미립자 초경합금(0.2 $\mu$ m)을 채택, 고속절삭시 뛰어난 성능 발휘

## Leading tools for machining of Composite materials

우주항공 및 자동차 분야의 복합신소재 가공을 선도하는

**FOR COMPOSITE**

## For Composite Materials

복합소재용 엔드밀

Endmills for CFRP, GFRP, copper, copper alloys, glass/carbon fiber, non-ferrous and non-metallic materials.

강화플라스틱(CFRP,GFRP), 동및동합금, 유리/탄소섬유등 비철, 비금속 계열의 다양한 복합소재 전용 엔드밀

- Outstanding performance in machining of various composite materials.
- Excellent wear resistance by applying high hardness coating layer.
- Minimize built up edge by low friction diamond coating.
- 다양한 복합소재 가공영역에 뛰어난 성능을 발휘
- 코팅피막에 경도가 높아 내마모성이 우수
- 마찰계수가 낮은 다이아몬드 코팅을 적용하여 흡착현상을 최소화



## Innovative solution for shortening machining hour !

가공시간 단축을 위한 획기적인 제안 !

### 5 Axis Taper Double Ball End Mills

5축 테이퍼 더블 볼 엔드밀

**4&6CTDB**

- **Pre-hardened steels, Cast irons, Non-metallic materials**
- HR coating provides wear resistance improvement as well as avoid edge stress in various applications.
- Suitable for special components with 3 axes and 5 axes sector such as impellers, blisks, tire profiles, turbine blades.
- Available for simultaneous machining of roughing and finishing with only one tool.
- **프리하든강, 일반강, 주물, 비철합금가공엔드밀**
- HR 코팅 처리하여 다양한 피삭재 가공시 인선부에 스트레스가 적으며, 내마모성 또한 향상됩니다.
- 공구의 교체없이 밀면과 경사면의 정삭, 황삭 가공이 동시에 가능합니다.
- 임펠러, 브리스크, 타이어 프로파일, 터빈날 등 3축과 5축의 편축각이 있는 부품 가공에 적합합니다.

The value of ae is same. ae의 치수 동일

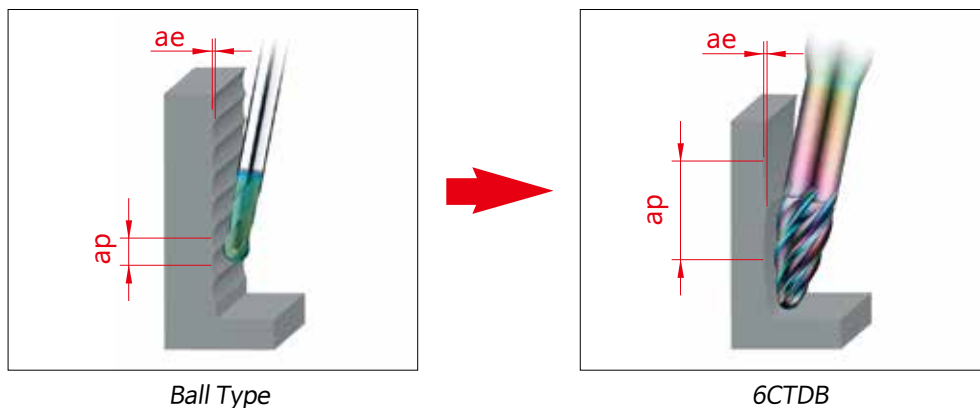

- The depth ( $ap$ ) can be processed deeper than the standard ball End mills during 5-axis machining, so the processing time is faster and it has fewer machining bumps, which is the advantage for finishing.
- Applied 4&6 flutes for high speed milling.
- 5축 가공시 일반 볼 엔드밀에 비해 절입깊이( $ap$ )를 깊게 가공할 수 있어 가공시간이 빠르며, 같은  $ae$  절입시 요철 가공면이 적어 정삭가공에 유리합니다.
- 4&6날을 채택하여 고속가공에 적합합니다.



**High abrasion resistance**

탁월한 내마모성의

# DIAMOND Coating 코팅!



- CR**
- R0.02
  - R0.05
  - R0.1
  - R0.15
  - R0.2
  - R0.3
  - R0.5

**2 D BE**

**3 D BE**

**4 D BE**

**2&3 D EM**

**4&6 D EM**

**2 D CR**

**4 D CR**

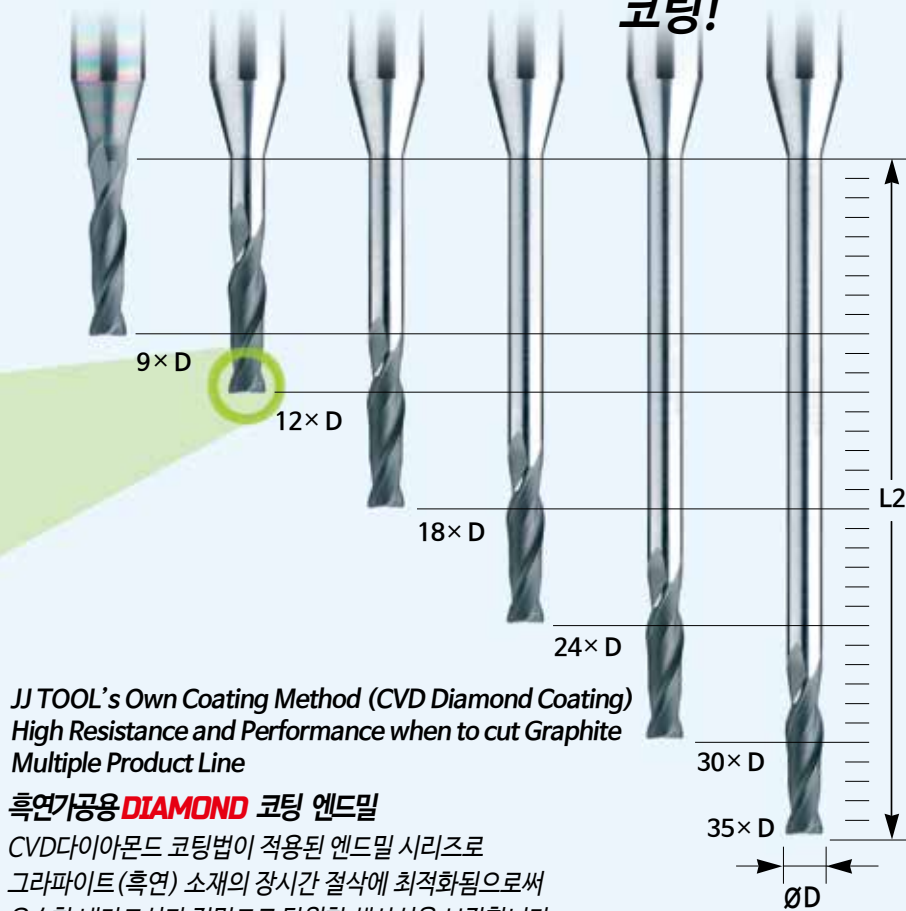

JJ TOOL's Own Coating Method (CVD Diamond Coating)  
High Resistance and Performance when to cut Graphite  
Multiple Product Line

흑연가공용 **DIAMOND** 코팅 엔드밀

CVD다이아몬드 코팅법이 적용된 엔드밀 시리즈로

그라파이트(흑연) 소재의 장시간 절삭에 최적화됨으로써  
우수한 내마모성과 정밀도로 탁월한 생산성을 보장합니다.

**FOR GRAPHITE**

## DIAMOND Coated End Mills for Graphite

### 다이아몬드 코팅 시리즈

SEM Images of Diamond crystal    다이아몬드 결정 SEM 사진

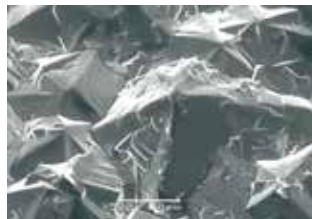

Diamond surface image  
다이아몬드 표면 입자 확대

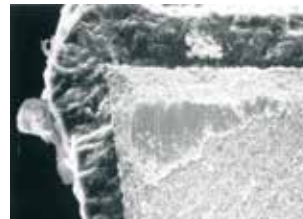

Diamond cross section image  
다이아몬드 단면 확대

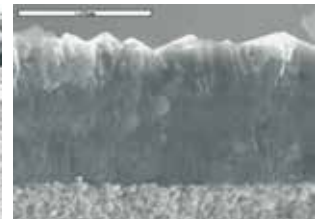

Diamond cross section image  
다이아몬드 단면 확대

PROPERTY	CVD Diamond	Mono Diamond	PCD	K10
열전도율 (W/m·K) Thermal conductivity	~ 1000	2,000	560	110
경도 (Gpa) Hardness	80 ~ 100	50 ~ 100	50	18
표면조밀도 (MPa·m <sup>1/2</sup> ) Toughness	5 ~ 6	3.4	8 ~ 9	10.5
인장력 (Gpa) Tensile strength	400 ~ 800	1,000~3,000	1,260	-
압축강도 (Gpa) Compressive strength	16.0	9.0	7.6	6.1
항절력 (Gpa) TRS	1.3	2.9	1.2	2.4

CVD diamond is a binderless- pure crystal, delivering identical properties of single diamond crystal. JJ TOOLS is applying the latest CVD coating technology which has no residual stress at the interface for extending tool life.

CVD 다이아몬드는 바인더(활성계면제)가 없는 순수결정체로서 단결정 다이아몬드와 동일한 특성을 나타내며, 변형없는 코팅의 우수함으로 강력한 절삭력과 공구수명이 향상됩니다.

# FINISHING 초경 정삭용 인서트 INSERT

**High quality surface roughness  
with great clamping precision !**

**높은 체결 정밀도 고품질의 절삭면 구현!**

- Ball Inserts for hardened steels (~HRC62), pre-hardened and graphite (DIA Coating) materials.
- Optimum for wear resistance by TISIN-S coating.
- Excellent clamping precision when clamping insert.
- Excellent concentricity when clamping inserts.
- 고경도강(HRC62이하), 프리하든강 계열의 고정밀 가공인서트, 흑연(DIA코팅)
- TISIN-S 코팅 처리하여 인선부 내마모성이 탁월합니다.
- 인서트 체결시 체결 정밀도가 뛰어납니다.
- 인서트 체결시 동심도가 탁월합니다.



## New Products

Shrink-Fit Head Changer  
열박음 헤드 체인저

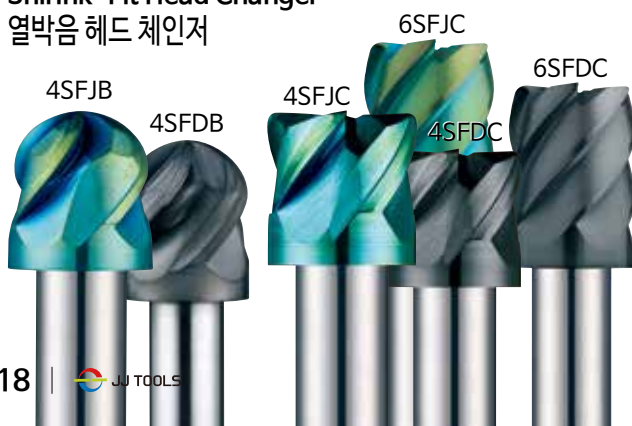

- Shrink fit inserts for hardened steel (HRC52~62), pre-hardened steel, graphite (DIA Coating).
- Excellent holding power and concentricity keeping are available by shrink fitting holder.
- Maximize cutting force by applying the new helix edge design.
- Minimize fracturing by high TRS fine (0.4 $\mu$ m) WC grade.
- 고경도강(HRC52~62), 프리하든강, 흑연(DIA코팅) 계열의 고정밀가공 열박음 인서트
- 열박음 홀더 체결시 높은 파지력과 뛰어난 동심도 유지가 가능합니다.
- 헬릭스 형상의 인선부를 설계하여, 절삭력이 향상되었습니다.
- 항절력이 높은 미립자 초경합금(0.4 $\mu$ m)을 채택, 인서트의 파손을 최소화 하였습니다.

# LOW Price HIGH Performance

Price Satisfaction, Performance Satisfaction -  
Multi functional Flat Drill Series

## FLAT DRILL

가격만족, 성능만족- 다기능 플랫드릴 시리즈

Multiple processing is available with one drill !

하나의 드릴로 다양한 가공 가능

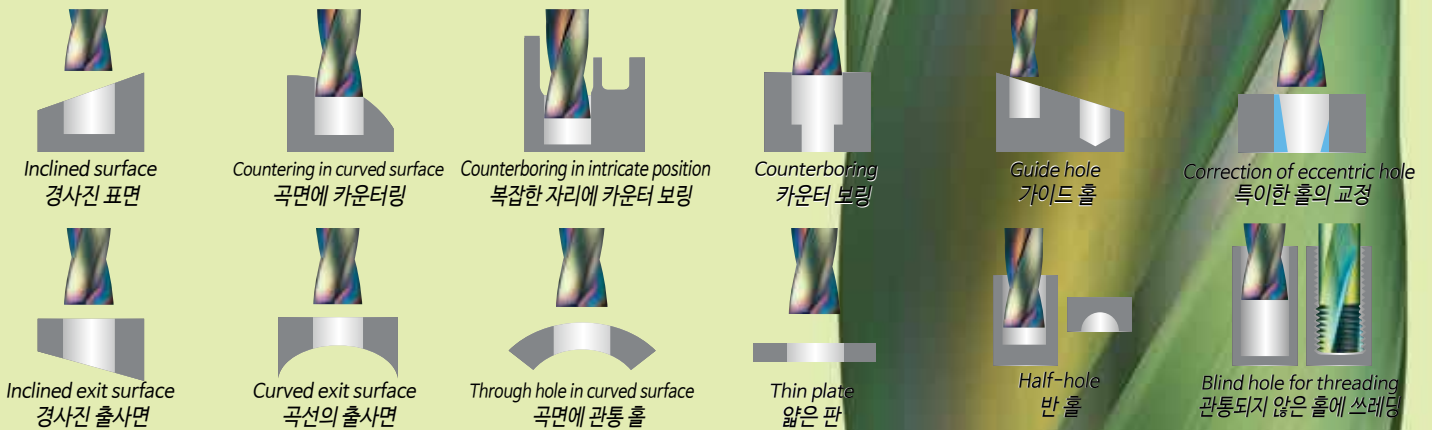

Helix 20°, Excellent chip emission !  
헬릭스 20°, 뛰어난 칩 배출력 !



Helix 24~30°, Coolant hole type !  
헬릭스 24~30°, 오일 홀 타입 적용 !

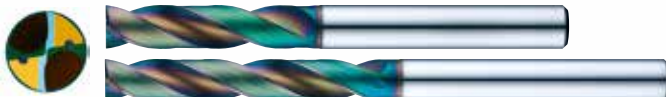

**Double Satisfaction!**

**Customized carbide drill to be coated for various workpieces**



# 2DUBE DRILL series

두배 만족! 피삭재 맞춤 코팅 전용 드릴

**Enhance Durability!**  
뛰어난 내구성!

**Reduce Cutting Resistance!**  
절삭저항 감소!

**2DUBES**



TISIN + @ Base for a Wide Range of Cutting Conditions up to HRC 48! Applied HR Coating for Maximizing Tool Lifespan with Excellent Wear Resistance and Chipping Resistance!

TISIN + @ Base로 HRC 48이하의 광범위한 절삭영역! 우수한 내마모성과 내치핑성으로 공구의 수명을 극대화시키는 HR코팅 적용!



**2DUBEW**



ALCRN + @ Base for Optimized High-Speed Drilling of SUS and Titanium!

Applied Cross Cut Coating with Exceptional Wear Uniformity and Heat Resistance through a Unique Nanostructure!

ALCRN + @ Base로 SUS 및 Titanium 등 강력한 고속 드릴링의 최적화!

독특한 나노구조로 균일 마모의 특성과 내열성이 뛰어난 Cross Cut 코팅 적용!

**2DUBE**

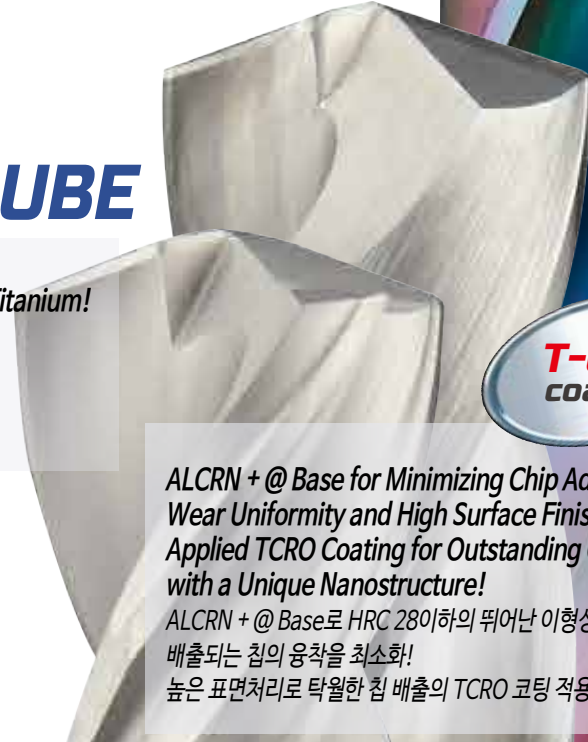

ALCRN + @ Base for Minimizing Chip Adhesion with Excellent Wear Uniformity and High Surface Finish!

Applied TCRO Coating for Outstanding Chip Evacuation with a Unique Nanostructure!

ALCRN + @ Base로 HRC 280이하의 뛰어난 이형성과 저 마찰로 배출되는 칩의 응착을 최소화!

높은 표면처리로 탁월한 칩 배출의 TCRO 코팅 적용!



This will change the meaning of innovation !  
지금까지의 혁신의 의미를 바꾼다 !



### Advantages of Laser cutting 레이저 가공의 장점

- The sharpness of the edge can be achieved below  $5\mu\text{m}$ , minimizing damage to the work material during machining, and improve cutting force to maximize machining performance and surface roughness.
- Laser processing can be applied in  $\mu\text{m}$  units, and 5-axis machining can produce and process various shapes. Also, it has the best performance with precise R shape.
- Chip breaker processing method can only be produced by laser processing, preventing chip load in advance, and minimizing bad effects on the work materials caused by chip.
- 인선부의 Sharpness를  $5\mu\text{m}$ 이하로 가공이 가능하며, 정밀한 R형상 구현에 최고의 성능을 발휘합니다.
- 피삭재에 가해지는 데미지는 최소화하고 가공성은 극대화 함으로써, 가공물의 조도가 우수합니다.
- 칩 브레이커 가공이 가능하며, 칩 말림을 방지하고 칩으로 인한 악영향을 최소화합니다.

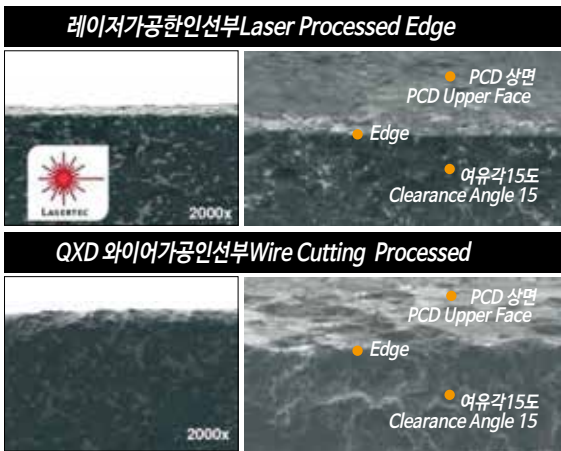

## Laser machining method to achieve ultimate surface roughness

최상의 표면조도를 위한 레이저 가공

### PCD (Polycrystalline diamond) EndMills series

#### PCD 엔드밀 시리즈

Endmills for Graphite, Aluminum, AL alloy, non-ferrous and non-metallic materials.

흑연, 알루미늄 및 알루미늄 합금 등 비철, 비금속 전용

- Using PCD (Polycrystalline Diamond) tool to cut aluminum or copper alloys, the machining accuracy is excellent, and surface roughness such as mirror finishing can be achieved.
- PCD has very high hardness and can also be applied to cutting ceramic or ultra-hard alloy. Also, the thermal conductivity is very high, indicating suitability cutting titanium alloy.
- 알루미늄 합금이나 동 합금 가공시 가공 정밀도가 매우 우수하고, 경면과 같은 표면조도를 얻을 수 있습니다.
- PCD는 경도가 매우 높아 세라믹이나 초경합금의 절삭이 가능하며, 열전도율 또한 우수해 Ti합금 등의 절삭시에도 탁월한 성능을 발휘합니다.



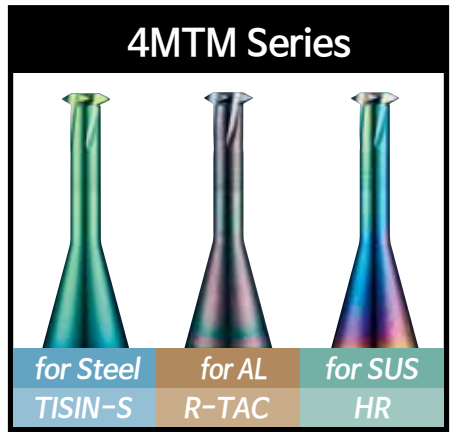
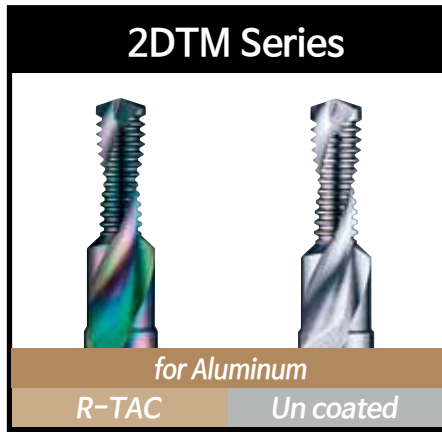

**Lineup optimized for threading suitable for various work materials.**

다양한 피삭재에 맞춘 나사가공에 최적화된 라인업!

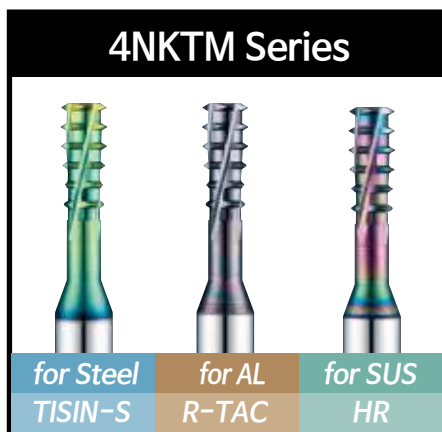
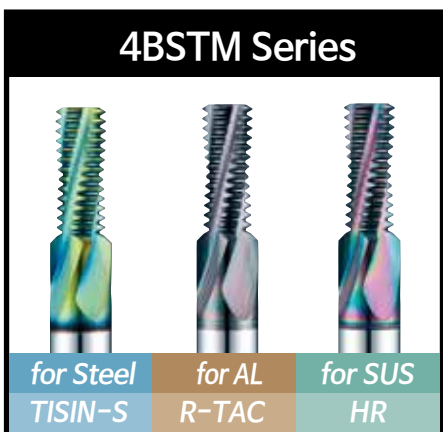
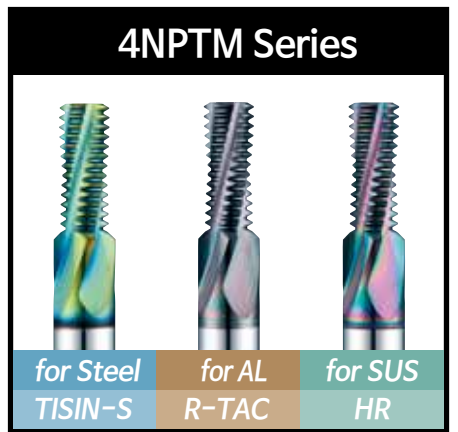
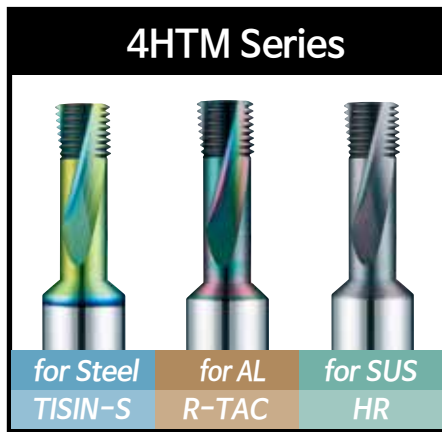

New

**4ETMR Series**

for Steel TISIN-S	for AL R-TAC	for SUS HR
----------------------	-----------------	---------------

**4LTM Series**

for Steel TISIN-S	for AL R-TAC	for SUS HR
----------------------	-----------------	---------------

**TRTM Series**

for Steel TISIN-S	for SUS HR
----------------------	---------------

Various Products Lineup!

# THREAD MILLS

- High-precision chucking system, which has same or higher level of clamping power as shrink-fit chuck or hydraulic chuck, is recommended for thread milling operations below M6.
- M6 이하의 쓰레드밀 작업시 열박음척, 유압척 이상의 고정밀 척킹 시스템을 권장합니다.

**4BSP Series**

for Steel TISIN-S	for AL R-TAC	for SUS HR
----------------------	-----------------	---------------

**4HBSP Series**

for Steel TISIN-S	for AL R-TAC	for SUS HR
----------------------	-----------------	---------------









































**4BSPT Series**

for Steel TISIN-S	for AL R-TAC	for SUS HR
----------------------	-----------------	---------------

**4NPTS Series**

for Steel TISIN-S	for AL R-TAC	for SUS HR
----------------------	-----------------	---------------





# Carbide End Mills INDEX

시리즈 SERIES	제품 IMAGE	품명 MODEL NO.	크기 SIZE Ø (mm)	페이지 PAGE	분류 TYPE
CBN series Cubic Boron Nitride		2BCBN	0.2 ~ 6	38	CBN Rib Ball End Mills CBN 리브 볼
		2SBCBN	0.2 ~ 6	40	CBN Straight Rib Ball End Mills CBN 직선날 리브 볼
		2ECBN	0.2 ~ 6	41	CBN Rib End Mills CBN 리브 엔드밀
		2CCBN	0.2 ~ 6	43	CBN Rib Corner Radius CBN 리브 코너 레디우스
		2SCCBN	0.4 ~ 6	46	CBN Straight Rib Corner Radius CBN 직선날 리브 코너 레디우스
		4SCCBN	0.8 ~ 6	48	CBN Straight Rib Corner Radius CBN 직선날 리브 코너 레디우스
JJ series 고경도용		2JJRB	0.1 ~ 12	50	JJ Rib Ball End Mills 제이제이 리브 볼
		3JJRB	1 ~ 12	53	JJ Rib Ball End Mills 제이제이 리브 볼
		2JJTB	0.2 ~ 12	54	Taper Neck Ball End Mills 제이제이 테이퍼 넥 볼
		3JJTBS	1 ~ 12	57	Taper Neck Ball End Mills 소비자 맞춤 테이퍼 넥 볼
		2JJSP	1 ~ 12	58	End Mills for 3D Cut 230° 3D 230° 가공용 구형 엔드밀
		4JJSP	1 ~ 12	59	End Mills for 3D Cut 230° 3D 230° 가공용 구형 엔드밀
		4JJSPM	1 ~ 12	60	End Mills for 3D Cut 270° 3D 270° 가공용 구형 엔드밀
		2JJSB	0.1 ~ 12	61	JJ Short Length Ball End Mills 제이제이 짧은 길이 볼
		2JJB	0.1 ~ 12	62	JJ Ball End Mills 제이제이 볼
		3JJB	1 ~ 12	63	JJ Ball End Mills 제이제이 볼
		4JJSB	1 ~ 12	63	JJ Short Length Ball End Mills 제이제이 짧은 길이 볼
		4JJB	1 ~ 20	64	JJ Ball End Mills 제이제이 볼
		2JJRE	0.1 ~ 12	65	JJ Rib End Mills 제이제이 리브 엔드밀
		4JJRE	0.5 ~ 12	67	JJ Rib End Mills 제이제이 리브 엔드밀
		2JJE	0.03 ~ 20	69	JJ End Mills 제이제이 엔드밀
		4JJE	0.3 ~ 20	70	JJ End Mills 제이제이 엔드밀
		4JJHE	0.3 ~ 20	71	JJ 45° Helix End Mills 제이제이45° 헬릭스엔드밀
		6&8JJHE	3 ~ 25	72	JJ 45° Helix End Mills 제이제이45° 헬릭스엔드밀
		2JJCR	0.2 ~ 16	73	JJ Rib Corner Radius 제이제이 리브 코너 레디우스
		2JJTC	1 ~ 4	77	Taper Neck Corner Radius 테이퍼 넥 코너 레디우스
		4JJCR	0.5 ~ 12	79	JJ Rib Corner Radius 제이제이 리브 코너 레디우스
		6JJCR	3 ~ 12	83	JJ Rib Corner Radius 제이제이 리브 코너 레디우스
		4JJTC	1 ~ 4	85	Taper Neck Corner Radius 테이퍼 넥 코너 레디우스
		2JJC	0.2 ~ 12	86	JJ Corner Radius 제이제이 코너 레디우스
		4JJC	0.4 ~ 16	88	JJ Corner Radius 제이제이 코너 레디우스
		<b>New</b> 4JJCRL	1 ~ 20	90	JJ 45° Helix Corner Radius 제이제이45° 헬릭스 코너 레디우스
		6JJCRL	3 ~ 16	91	JJ 45° Helix Corner Radius 제이제이45° 헬릭스 코너 레디우스
		4&6JJRC	1 ~ 16	92	High Speed Radius Cutters 고이송 코너 레디우스 커터
	4&6JJDRC	1 ~ 12	93	JJ Double Corner Radius 제이제이 더블 코너 레디우스	
	5JJROU	6 ~ 20	94	Variable Helix Roughing 가변형 헬릭스 라핑	
HARD series 고속 가공용		2HRB	0.1 ~ 12	95	Rib Ball End Mills 리브 볼
		2PHCB	0.2 ~ 12	98	Ultra Precision Ball End Mills 초정밀 표준 길이 볼
		2HSB	0.1 ~ 12	99	Short Length Ball End Mills 짧은 길이 볼
		2HCB	0.06 ~ 20	100	Standard Length Ball End Mills 표준 길이 볼

















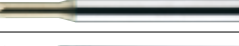

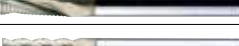



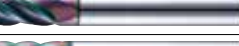

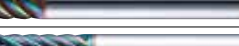













# Carbide End Mills INDEX

시리즈 SERIES	제품 IMAGE	품명 MODEL NO.	크기 SIZE Ø (mm)	페이지 PAGE	분류 TYPE
HARD series 고속 가공용		3HCB	1 ~ 12	101	Standard Length Ball End Mills 표준 길이 볼
		4HSB	1 ~ 12	101	Short Length Ball End Mills 짧은 길이 볼
		4HCB	1 ~ 20	102	Standard Length Ball End Mills 표준 길이 볼
		2HRE	0.1 ~ 12	103	Rib End Mills 리브 엔드 밀
		4HRE	0.5 ~ 12	105	Rib End Mills 리브 엔드 밀
		2HSE	0.1 ~ 12	107	Short Length End Mills 짧은 길이 엔드밀
		2HCE	0.05 ~ 20	108	Standard Length End Mills 표준 길이 엔드밀
		2LEM	1 ~ 25	110	Long Length End Mills 긴 길이 엔드밀
		4HSE	0.5 ~ 16	111	Short Length End Mills 짧은 길이 엔드밀
		4HCE	0.3 ~ 20	112	Standard Length End Mills 표준 길이 엔드밀
		4LEM	0.5 ~ 25	113	Long Length End Mills 긴 길이 엔드밀
		4HEM	1 ~ 25	114	45° Helix End Mills 45° 헬릭스엔드밀
		6&8HEM	3 ~ 25	115	45° Helix End Mills 45° 헬릭스엔드밀
		2CRE	0.2 ~ 16	116	Rib Corner Radius 리브 코너 레디우스
		4CRE	0.8 ~ 12	120	Rib Corner Radius 리브 코너 레디우스
		2NCR	0.2 ~ 16	124	Corner Radius End Mills 코너 레디우스
		4NCR	0.5 ~ 20	126	Corner Radius End Mills 코너 레디우스
		4CRL	1 ~ 20	128	45° Helix Radius Long 45° 헬릭스 코너 레디우스 롱
		6CRL	3 ~ 16	129	45° Helix Radius Long 45° 헬릭스 코너 레디우스 롱
		4RCU	1 ~ 16	130	High Speed Radius Cutters 고이송 코너 레디우스 커터
	6RCU	6 ~ 20	131	High Speed Radius Cutters 고이송 코너 레디우스 커터	
	3&4ROU	4 ~ 20	132	Roughing End Mills 라핑 엔드밀	
	3&4HROU	4 ~ 20	133	45° Helix Fine Pitch Roughing 45° 헬릭스 파인피치형 라핑	
E series 강력절삭용		2HRBE	0.2 ~ 12	134	Rib Ball End Mills for Heavy Cuts 강력절삭용 리브 볼
		2HCBE	0.2 ~ 16	136	Ball End Mills for Heavy Cuts 강력절삭용 볼
		2HCEE	0.2 ~ 16	137	End Mills for Heavy Cuts 강력절삭용 엔드밀
		4HCEE	1 ~ 16	138	End Mills for Heavy Cuts 강력절삭용 엔드밀
		3NSE	1 ~ 12	139	45° Helix End Mills for Heavy Cuts 강력절삭용 45° 헬릭스
		4NSE	1 ~ 20	140	End Mills for Heavy Cuts 강력절삭용 엔드밀
		4HEME	1 ~ 16	141	End Mills for Heavy Cuts 강력절삭용 엔드밀
		2NCRE	1 ~ 12	142	Corner Radius End Mills for Heavy Cuts 강력절삭용 코너 레디우스
		4NCRE	1 ~ 12	143	Corner Radius End Mills for Heavy Cuts 강력절삭용 코너 레디우스
	4RCUE	1 ~ 12	144	High Speed Corner R Cutters 강력절삭용 고이송 코너R 커터	
G series 범용		2HRBG	0.1 ~ 12	145	Rib Ball End Mills 리브 볼
		2HSBG	0.2 ~ 12	147	Short Length Ball End Mills 짧은 길이 볼
		2HCBG	0.1 ~ 20	148	Standard Length Ball End Mills 표준 길이 볼
		2HREG	0.1 ~ 12	149	Rib End Mills 리브 엔드밀
		4HREG	0.8 ~ 12	151	Rib End Mills 리브 엔드밀
		2HCEG	0.1 ~ 20	152	Standard Length End Mills 표준 길이 엔드밀
		2LEMG	1 ~ 25	153	Long Length End Mills 긴 길이 엔드밀



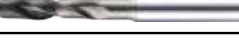









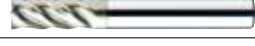

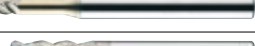

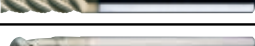

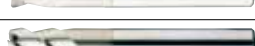











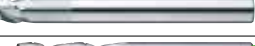

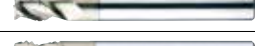
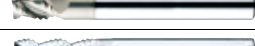
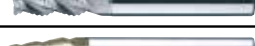
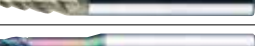

프리하든강 Pre-hardened Steel	하든강 Hardened Steel			합금강/공구강 Alloy Steel Tool Steel	내열 합금강 Heat Resistance Alloy	티타늄 Titanium	스테인레스강 Stainless Steel	알루미늄 Aluminum	구리 Copper	탄소강 Carbon Steel	흑연 Graphite	복합소재 CFRP GFRP
	~ HRC55	HRC55 ~ 65	HRC65 ~									
★	★	★	◎	★		◎			○	○	○	
★	★	★	◎	◎		◎			○	○	○	
★	★	★	◎	◎		◎			○	○	○	
★	◎	○		○		○			○	○	○	
★	★	◎	○	◎		◎			○	○	○	
★	◎	○		○		◎			○	○	○	
★	◎	○		○		○			○	○	○	
★	◎	○		○					○	◎	○	
★	★	◎	○	◎		◎			○	◎	○	
★	★	◎	○	◎		◎			○	◎	○	
★	★	○		○	◎				○	◎	○	
★	★	◎	○	★	○	◎			○	◎	○	
★	★	★	◎	★	○	◎			○	◎	○	
★	◎	○		○		○			○	○	○	
★	★	◎		◎		◎			○	○	○	
★	◎	○		○		○			○	○	○	
★	★	◎		◎		◎			○	◎	○	
★	★	◎	○	○	◎	◎	○		○	◎	○	
★	★	★	◎	◎		◎			○	◎	○	
★	★	◎		◎					○	◎	○	
★	★	◎		◎					○	◎	○	
★	◎	○		○					○	○	○	
★	★	◎		○					○	○	○	
★	◎	○		◎		◎			◎	◎	○	
★	◎	○		◎		◎			◎	◎	○	
★	◎	○		◎		◎			◎	◎	○	
★	◎	○		◎		◎			◎	◎	○	
★	◎	○		◎		◎			◎	◎	○	
★	◎	○		◎		◎			◎	◎	○	
★	◎	○		◎		◎			◎	◎	○	
★	◎	○		◎		◎			◎	◎	○	
★	◎	○		◎		◎			◎	◎	○	
★	◎	○		◎		◎			◎	◎	○	
★	◎	○		◎		◎			◎	◎	○	
★	◎	○		◎		◎			◎	◎	○	
★	◎	○		◎		◎			◎	◎	○	
★	◎	○		◎		◎			◎	◎	○	
★	◎	○		◎		◎			◎	◎	○	
★	◎	○		◎		◎			◎	◎	○	
★	◎	○		◎		◎			◎	◎	○	

# Carbide End Mills INDEX

시리즈 SERIES	제품 IMAGE	품명 MODEL NO.	크기 SIZE Ø (mm)	페이지 PAGE	분류 TYPE
G series 범용		4HCEG	0.8 ~ 20	154	Standard Length End Mills 표준 길이 엔드밀
		4LEMG	1 ~ 25	155	Long Length End Mills 긴 길이 엔드밀
		4HEMG	1 ~ 20	156	Helix End Mills 45° 헬릭스 엔드밀 45°
		2CREG	0.2 ~ 16	157	Rib Corner Radius 리브 코너 레디우스
		4CREG	1 ~ 12	160	Rib Corner Radius 리브 코너 레디우스
		2NCRG	0.4 ~ 12	163	Corner Radius End Mills 코너 레디우스
		4NCRG	1 ~ 16	165	Corner Radius End Mills 코너 레디우스
		3&4ROUG	4 ~ 20	167	Roughing End Mills 라핑 엔드밀
New V series 고능률 범용		4VSB	1 ~ 25	169	Various Symmetry End Mills 고능률 범용 볼 엔드밀
		4VSE	1 ~ 20	170	Various Symmetry End Mills 고능률 범용 엔드밀
		6VSE	3 ~ 20	171	Various Symmetry End Mills 고능률 범용 엔드밀
		4SLE	3 ~ 20	172	High Speed Slotting End Mills 고속 슬로팅 엔드밀
		4VCC	1 ~ 20	173	Various Symmetry C End Mills 고능률 범용 C 엔드밀
		5VCC	6 ~ 20	174	Various Symmetry Corner C End Mills 고능률 범용 코너 C 엔드밀
		4VSC	1 ~ 20	175	Various Symmetry Corner Radius End Mills 고능률 범용 코너 레디우스 엔드밀
		6VSC	6 ~ 20	176	Various Symmetry Corner Radius End Mills 고능률 범용 코너 레디우스 엔드밀
		7SUC	6 ~ 20	177	Non Symmetry Corner Radius 채터링 방지 코너 레디우스
		5&6TROE	6 ~ 20	178	Trochoidal Milling End Mills 트로코이달 가공 엔드밀
for GRAPHITE 흑연 가공용		2GBE	0.5 ~ 25	179	Long Shank Ball End Mills 롱 샹크 볼
		2TGB	1 ~ 12	180	Taper Neck Ball End Mills 테이퍼 넥 볼
		2GEM	0.5 ~ 20	181	Long Shank End Mills 롱 샹크 엔드밀
		4GEM	3 ~ 20	182	Long Shank End Mills 롱 샹크 엔드밀
		6GEM	6 ~ 20	183	45° Helix Long Shank End Mills 45° 헬릭스 롱 샹크 엔드밀
		2DBE	0.2 ~ 12	184	Diamond Coated Ball End Mills 다이아몬드 코팅 볼
		3DBE	1 ~ 12	186	Diamond Coated Ball End Mills 다이아몬드 코팅 볼
		3TBD	1 ~ 4	187	Diamond Coated Taper Neck Ball 다이아몬드 코팅 테이퍼 넥 볼
		4DBE	1 ~ 12	188	Diamond Coated Ball End Mills 다이아몬드 코팅 볼
		2DEM	0.2 ~ 12	189	Diamond Coated End Mills 다이아몬드 코팅 엔드밀
		3DEM	1 ~ 12	190	Diamond Coated End Mills 다이아몬드 코팅 엔드밀
		4&6DEM	2 ~ 16	191	Diamond Coated End Mills 다이아몬드 코팅 엔드밀
		2DCR	0.2 ~ 6	192	Diamond Coated Radius 다이아몬드 코팅 코너 레디우스
		4DCR	2 ~ 12	194	Diamond Coated Radius 다이아몬드 코팅 코너 레디우스
for COMPOSITE 복합소재 가공용		2CPB	0.5 ~ 12	195	Ball End Mills for Composite 복합소재용 볼
		8~12CPE	6 ~ 12	195	Finishing End Mills for Composite 복합소재용 정삭 엔드밀
		3&4&6CPR	6 ~ 12	196	Router for Composite 복합소재용 라우터
		6~16CPO	2 ~ 12	196	Router for Composite 복합소재용 라우터
for SUS & TITANIUM		2DDCA	2 ~ 12	197	Diamond Coated Drills 복합소재용 다이아몬드 코팅 드릴
		3SUB	1 ~ 12	198	45° Helix Rib Ball End Mills 45° 헬릭스 리브 볼
		4SUB	1 ~ 16	199	45° Helix Ball End Mills 45° 헬릭스 볼

프리하든강 Pre-hardened Steel	하든강 Hardened Steel			합금강/공구강 Alloy Steel Tool Steel	내열 합금강 Heat Resistance Alloy	티타늄 Titanium	스테인레스강 Stainless Steel	알루미늄 Aluminum	구리 Copper	탄소강 Carbon Steel	흑연 Graphite	복합소재 CFRP GFRP
	~ HRC55	HRC55 ~ 65	HRC65 ~									
★	◎	○		○		○	◎		◎	◎		
★	◎	○		○		○	◎		◎	◎		
★	◎	○		○	◎	○	◎		◎	◎		
★	◎	○		○		○	◎		◎	◎		
★	◎	○		○		○	◎		◎	◎		
★	◎	○		○		○	◎		◎	◎		
★	◎	○		○		○	◎		◎	◎		
★	◎	○		○		○	◎		◎	◎		
★	◎	○		○		○	◎		◎	◎		
★	○			◎	○	○	◎		◎	◎		
★	○			◎	○	○	◎		◎	◎		
★	○			◎	○	○	◎		◎	◎		
◎	○			◎	○	◎	★		◎	◎		
★	○			◎	○	○	◎		◎	◎		
★	○			◎	○	○	◎		◎	◎		
★	○			◎	○	○	◎		◎	◎		
★	○					○	◎			◎		
★	◎					★	◎			◎		
★	○					★	◎			◎		
◎									○		◎	○
◎									○		◎	○
◎									○		◎	○
◎									○		◎	○
◎									○		◎	○
											★	◎
											★	◎
											★	○
											★	◎
											★	◎
											★	◎
											★	◎
											★	◎
											◎	★
											◎	★
											◎	★
											◎	★
											◎	★
◎	○				◎	◎	★		◎	○		
◎	○				◎	◎	★		◎	○		















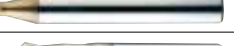
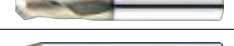

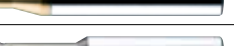
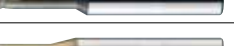
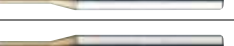
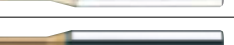



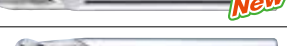
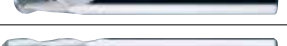

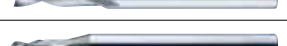







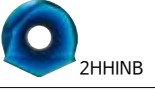

# Carbide End Mills INDEX

시리즈 SERIES	제품 IMAGE	품명 MODEL NO.	크기 SIZE Ø (mm)	페이지 PAGE	분류 TYPE
for SUS & TITANIUM SUS, 내열합금 티타늄, 인코넬 가공용		3SUE	0.5 ~ 20	200	45° Helix End Mills 45° 헬릭스 엔드밀
		4SURE	1 ~ 20	201	Rib End Mills 리브 엔드밀
		4SUE	0.3 ~ 20	202	Non Symmetry End Mills 채터링 방지 엔드밀
		4SUV	1 ~ 20	204	Variable Helix End Mills 강력절삭용 엔드밀
		4SUCR	1 ~ 20	205	Rib Corner Radius 리브 코너 레디우스
		4SUC	1 ~ 20	206	Non Symmetry Corner Radius 채터링 방지 코너 레디우스
		4LSUC	6 ~ 20	207	Long Length Corner Radius 긴길이 코너 레디우스
		3&4&5SUR	3 ~ 20	208	45° Helix Roughing Core R 45° 헬릭스 라핑 코너 R
for COPPER 구리가공용		2COB	0.5 ~ 16	209	45° Helix Rib Ball End Mills 45° 헬릭스 리브 볼
		2COR	1 ~ 12	210	Rib Corner Radius 리브 코너 레디우스
		3COR	1 ~ 12	212	45° Helix Rib Radius 45° 헬릭스 리브 코너 레디우스
R-TAC Diamond Like Carbon		2DRB	0.1 ~ 12	213	R-TAC Coated Rib Ball End Mills R-TAC코팅 리브 볼
		2DLB	0.2 ~ 12	214	R-TAC Coated Ball End Mills R-TAC코팅 볼
		2DRE	0.1 ~ 12	215	R-TAC Coated Rib End Mills R-TAC코팅 리브 엔드밀
		3DRE	1 ~ 12	216	45° Helix R-TAC Coated Rib 45° 헬릭스 R-TAC코팅 리브
		2DLE	0.4 ~ 12	217	R-TAC Coated End Mills R-TAC코팅 엔드밀
		2DLC	0.2 ~ 12	218	R-TAC Coated Corner Radius R-TAC코팅 코너 레디우스
for ALUMINUM 알루미늄가공	 <i>New</i>	2ALB	0.5 ~ 16	220	45° Helix Ball End Mills 45° 헬릭스 볼 엔드밀
		3ALR	0.8 ~ 20	222	45° Helix Rib End Mills 45° 헬릭스 리브 엔드밀
		2ALE	0.5 ~ 20	224	45° Helix End Mills 45° 헬릭스 엔드밀
		3FALE	4 ~ 16	227	Mirror Finishing Cutting End Mills 고광택 정삭 엔드밀
		3ALE	1 ~ 20	228	45° Helix End Mills 45° 헬릭스 엔드밀
	 <i>New</i>	4ALE	3 ~ 20	231	38° High Speed End Mills 38° 고이송 엔드밀
		3ALC	3 ~ 20	232	45° Helix Corner Radius 45° 헬릭스 코너 레디우스
	 <i>New</i>	3ALCB	3 ~ 20	234	High Speed Roughing End Mills 고이송 황삭 전용 엔드밀
		3ARE	6 ~ 20	235	Semi Finishing & Roughing 세미 피니싱 & 라핑
		3ARC	6 ~ 20	235	Semi Finishing & Roughing Radius 세미피니싱 & 라핑레디우스
		3ARO	4 ~ 20	236	45° Helix Roughing End Mills 45° 헬릭스 라핑 엔드밀
TAPER 테이퍼		3TBIC	1 ~ 6	237	Taper Ball End Mills for Impeller 임펠러 가공용 테이퍼 볼
		4&6CTDB	1 ~ 8	238	5 Axis Taper Double Ball 5축 테이퍼 더블 볼
		2CTB	0.2 ~ 6	239	Taper Ball End Mills 테이퍼 볼
		2CTE	0.2 ~ 8	241	Taper End Mills 테이퍼 엔드밀
		4CTE	3 ~ 10	243	Taper End Mills 테이퍼 엔드밀
		4RTE	0.5 ~ 2.5	244	Rib Taper End Mills 리브 테이퍼 엔드밀
GENERAL PURPOSE 범용		2CRC	0.5 ~ 3.9	245	Corner Rounding Cutters 코너 역R 커터
		4CRC	2.9 ~ 3.9	246	Corner Rounding Cutters 코너 역R 커터
	 <i>New</i>	1HTE	1.2 ~ 16	247	45° Helix Taper End Mills 45° 헬릭스 테이퍼 엔드밀
		1STE	0 ~ 0.3	248	Straight Flute Taper End Mills 직선날 테이퍼 엔드밀
		2STE	0	249	Straight Flute Taper End Mills 직선날 테이퍼 엔드밀
		4STE	0	250	Straight Flute Taper End Mills 직선날 테이퍼 엔드밀

★ 최적 Most Suitable / ◎ 적합 Suitable / ○ 가능 Available

프리하든강 Pre-hardened Steel	하든강 Hardened Steel ~ HRC55   HRC55~ 65	합금강/공구강 Alloy Steel Tool Steel	내열 합금강 Heat Resistance Alloy	티타늄 Titanium	스테인레스강 Stainless Steel	알루미늄 Aluminum	구리 Copper	탄소강 Carbon Steel	흑연 Graphite	복합소재 CFRP GFRP	A.B.S수지 Resin
◎	◎		◎	◎	★		◎	○			
◎	○		◎	◎	★		◎	○			
◎	○		◎	◎	★		◎	○			
★	◎		◎	◎	★		◎	○			
◎	○		◎	◎	★		◎	○			
◎	○		◎	◎	★		◎	○			
◎	○		◎	◎	★		◎	○			
◎	○		◎	◎	★		◎	○			
					◎	◎	★				
					◎	◎	★				
					◎	◎	★				
						★	◎		○	○	◎
						★	◎		○	○	◎
						★	◎		○	○	◎
						★	◎		○	○	◎
						★	◎		○	○	◎
						★	◎		○	○	◎
						★					
						★					
						★					
						★					○
						★					
						★					
						★					
						★	◎				
						★	◎				
						★	◎				
★	★	○	◎	★	★		◎	○	◎		
◎		◎				◎		◎			○
★	★	○	◎	○	○	◎	◎	◎	◎		
★	★	○	◎	○	○	◎	◎	◎	◎		
★	★	◎	◎	◎	◎		◎	◎	◎		
★	★	◎	◎	○			◎	◎			
★	◎	○	◎	◎	○		◎	◎	○		
★	◎	○	◎	◎	○		◎	◎	○		
						★	◎				★
★	◎	○		◎	○	○	◎	○	○		
★	◎	○	○	◎	○	○	◎	○	○		
★	◎	○	◎	◎	○		◎	◎	◎		

































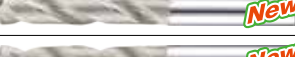
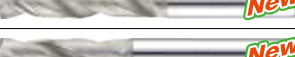



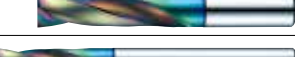

# Carbide End Mills INDEX

시리즈 SERIES	제품 IMAGE	품명 MODEL NO.	크기 SIZE Ø (mm)	페이지 PAGE	분류 TYPE
GENERAL PURPOSE 범용		1CHA	0.9 ~ 16	251	Chamfering Cutters 90° 면취커터 90°
		2CHA	0.8 ~ 1	252	Chamfering Cutters 90° 면취커터 90°
		3CHA	0.8 ~ 2	252	Chamfering Cutters 90° 면취커터 90°
		2CEN	0.2 ~ 16	253	Centering End Mills 센터링엔드밀
		2CENE	0.5 ~ 3	254	소경면취엔드밀 Miniature Chamfering End Mills
		2CCMC	1 ~ 12	255	Corner C End Mills 코너 45° 면취 엔드밀
		4TES	2 ~ 10	256	T Slot Cutters T 커터
		4TRS	4 ~ 12	257	T-R Slot Cutters T-R 커터
		3TRC	1.9 ~ 11.9	258	T Double Corner Rounding Cutters T 더블R 커터
		4&6TDA	1.5 ~ 12	259	T Double Angular Cutters T 더블앵글커터
		3&4THC	0.57 ~ 7.9	260	Thread Milling Cutters 홈가공용커터
		4&6TAC	1.5 ~ 12	261	T Angular Cutters T 앵글커터
	for A.B.S ABS수지, 비금속 가공		2MRB	0.2 ~ 6	262
		3MRB	1 ~ 16	263	Micro Rib Ball End Mills 범용 마이크로 리브 볼
		2MLB	0.2 ~ 16	264	Micro Long Ball End Mills 마이크로 롱 볼
		1MBE	1 ~ 16	266	Ball End Mills 볼 엔드밀
		2MBE	0.1 ~ 12	267	Ball End Mills 범용 볼 엔드밀
		3MBE	0.3 ~ 6	268	Ball End Mills 범용 볼 엔드밀
		1MEM	0.2 ~ 12	269	End Mills 엔드밀
		1REM	0.5 ~ 12	270	Reverse Edge End Mills 역날 엔드밀
		2MRE	0.2 ~ 6	271	Micro Rib End Mills 범용 마이크로 리브 엔드밀
		3MRE	1 ~ 16	272	Micro Rib End Mills 범용 마이크로 리브 엔드밀
		2MLE	0.2 ~ 16	273	Micro Long End Mills 마이크로 롱 엔드밀
		2MEM	0.1 ~ 12	275	End Mills 범용 엔드밀
		3MEM	0.3 ~ 6	276	End Mills 범용 엔드밀
		4MEM	1 ~ 12	277	End Mills 범용 엔드밀
INSERT 초경 인서트			2HHINB	10 ~ 33	278
		2HHINC	10 ~ 33	278	HH Helix Corner Radius HH헬릭스 코너R
		2JJINB	10 ~ 33	279	JJ Ball 제이제이 볼
		2JJINC	10 ~ 33	279	JJ Corner Radius 제이제이 코너R
		2GINB	10 ~ 33	280	Helix Ball for General Purpose 범용 헬릭스 볼
		2GINC	10 ~ 33	280	Helix Coner Radius for General Purpose 범용헬릭스코너R
		2DINB	10 ~ 30	281	Diamond Coated Ball 다이아몬드 코팅 볼
		2DINC	10 ~ 30	281	Diamond Coated Corner Radius 다이아몬드 코팅 코너R
		4SFJB	10 ~ 21	282	Helix Ball Shrink-fit 열박음 제이제이 볼
		4SFJC	10 ~ 21	282	Helix Corner Radius Shrink-fit 열박음 제이제이 코너R
		6~12SFJC	10 ~ 21	283	Helix Corner Radius Shrink-fit 열박음 제이제이 코너R
		4SFDB	10 ~ 21	283	Diamond Coated Ball Shrink-fit 열박음 다이아몬드 코팅 볼

























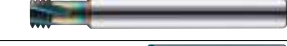













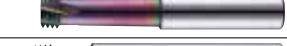

프리하든강 Pre-hardened Steel	하든강 Hardened Steel ~ HRC55 HRC55~ 65		합금강/공구강 Alloy Steel Tool Steel	내열 합금강 Heat Resistance Alloy	티타늄 Titanium	스테인레스강 Stainless Steel	알루미늄 Aluminum	구리 Copper	탄소강 Carbon Steel	흑연 Graphite	복합소재 CFRP GFRP	A.B.S수지 Resin
							★	◎				◎
★	◎	○	○		◎	◎	○	◎	○	○		
★	◎	○	◎		◎	◎	○	◎	◎	◎		
★	○					◎	○	◎		○		◎
★	○					◎	○	◎		○		
★	◎	○	○			◎	○	◎		○		
★	◎	○	○			◎	○	◎	◎	◎		
★	◎	○	○			◎	○	◎	◎	◎		
★	◎	○	○			◎	○	◎	◎	◎		
★	◎	○	○			◎	○	◎	◎	◎		
★	◎	○	○			◎	○	◎	◎	◎		
							◎	◎				★
							◎	◎				★
							◎	◎				★
							◎	◎				★
							◎	◎				★
							◎	○				★
							◎	○				★
							◎	○				★
							◎	○				★
							◎	○				★
							◎	○				★
							◎	○				★
							◎	○				★
★	★	★	◎						◎	○		
★	★	★	◎						◎	○		
★	★	◎	◎						◎	○		
★	★	◎	◎						◎	○		
★	◎		◎		○	○			◎	○		
★	◎		◎		○	○			◎	○		
										★	◎	
										★	◎	
★	★	◎	◎						◎	○		
★	★	◎	◎						◎	○		
★	★	★	◎						◎	○		
										★	◎	

# Carbide End Mills INDEX

시리즈 SERIES	제품 IMAGE	품명 MODEL NO.	크기 SIZE Ø (mm)	페이지 PAGE	분류 TYPE
INSERT 초경 인서트		4SFDC	10 ~ 21	284	Diamond Coated Corner Radius Shrink-fit 열박음 다이아몬드 코팅 코너R
		6~12SFDC	10 ~ 21	284	Diamond Coated Corner Radius Shrink-fit 열박음 다이아몬드 코팅 코너R
		MHE	10 ~ 30	285	Modular Head 모듈러 헤드
		CMA	10 ~ 30	285	Modular Adapter 모듈러 아답터
		CFMA	10 ~ 20	286	Shrink fit Modular Adapter 열박음 아답터 - 정 · 중삭용
		CICF	10 ~ 30	286	Indexable Cutters for finishing 인덱서블 커터
		ICF	10 ~ 30	287	Indexable Cutters for finishing 인덱서블 커터
PCD series Poly Crystalline Diamond		1&2BPCD	3 ~ 16	288	PCD Ball End Mills PCD 볼 엔드밀
		1~4PCD	3 ~ 20	289	PCD End Mills PCD 엔드밀
		2~4CPCD	6 ~ 20	290	PCD End Mills (Center Over) PCD 엔드밀(센터오버)
		1~3HPCD	4 ~ 20	291	PCD Helix End Mills PCD 헬릭스 엔드밀
		2&3RPCD	10 ~ 20	292	PCD Roughing End Mills PCD 라핑 엔드밀
		1&2PCDC	4 ~ 12	293	PCD Corner Radius End Mills PCD 코너R 엔드밀
		1&2BPCDW	3 ~ 12	294	PCD Ball End Mills PCD 볼엔드밀
		1&2PCDW	3 ~ 12	295	PCD End Mills PCD 엔드밀
DRILL 드릴		2SPO	0.3 ~ 16	297	NC Spotting Drills NC 스폿팅 드릴
		2STD	3.4 ~ 10.3	298	Step Drills 스텝 드릴
		2DED	0.15 ~ 6	299	Deburring Micro Drills 디버링 마이크로 드릴
		2MID	0.5 ~ 3	301	Micro Drills 마이크로 드릴
		3DUBEH	1 ~ 16	302	Dube H Drill for high hardened steels 두배 H 드릴
		2DUBES	1 ~ 20	304	Dube S Drills(Strong) - [3XD] 두배 S 드릴 [3XD]
		2DUBES	1 ~ 20	306	Dube S Drills(Strong) - [5XD] 두배 S 드릴 [5XD]
		2DUBE	1 ~ 12	308	Dube Drills(Short length) 짧은 길이 두배 드릴
		2DUBE	1 ~ 20	310	Dube Drills(Standard length) 두배 드릴
		4DUBE	6 ~ 12	312	Dube Drills(Standard length) 두배 드릴
		2DUBEV	1 ~ 20	313	Dube V Drills(Various) - [3XD] 두배 V 드릴 [3XD]
		2DUBEV	1 ~ 20	315	Dube V Drills(Various) - [5XD] 두배 V 드릴 [5XD]
		2DUBEW	1 ~ 20	317	Dube W Drills with Coolant hole [3XD] 두배 W 드릴(내부 쿨런트) [3XD]
		2DUBEW	1 ~ 20	319	Dube W Drills with Coolant hole [5XD] 두배 W 드릴(내부 쿨런트) [5XD]
		2DUBEN	1 ~ 13	321	Dube N Drills for Non-ferrous [3XD] 두배 N 드릴 [3XD]
		2DUBEN	1 ~ 13	323	Dube N Drills for Non-ferrous [5XD] 두배 N 드릴 [5XD]
		2FDR	0.2 ~ 20	325	Multi-Processing Flat Drills 다기능 플랫 드릴
		2FDRL	3 ~ 20	327	Multi-Processing Flat Drills with Long Shank 롱샹크 다기능 플랫 드릴
		2FDRW	3 ~ 16	328	Multi-Processing Flat Drills with Coolant hole 다기능 플랫 드릴(내부 쿨런트)
		2FDRLW	3 ~ 16	330	Multi-Processing Flat Drills with Coolant hole 긴 길이 다기능 플랫(내부 쿨런트)
THREAD MILL 쓰레드밀		4ETM	M3~M23 NO.4~40 ~ 3/8"-16	331	Multi-functional Thread Mills 범용 다기능 쓰레드밀(L Rotation)
		4ETMA	M1.4~M23 NO.4~40 ~ 3/8"-16	333	Thread Mills for Aluminum 알루미늄용 다기능 쓰레드밀(L Rotation)
		4ETMS	M3~M23 NO.4~40 ~ 3/8"-16	335	Multi-functional Thread Mills for SUS SUS용 다기능 쓰레드밀(L Rotation)
		4ETMR	M3~M23	337	for multi-functional engraving/router 범용 다기능 조각기용(R Rotation)



# Carbide End Mills INDEX

시리즈 SERIES	제품 IMAGE	품명 MODEL NO.	크기 SIZE Ø (mm)	페이지 PAGE	분류 TYPE
THREAD MILL 쓰레드밀		4ETMRA	M1.4~M23	338	for Aluminum engraving/router 알루미늄 전용 다기능 조각기용(R Rotation)
		4ETMRS	M3~M23	339	Multi-functional engraving/router for SUS SUS용 가공용 다기능 조각기용(R Rotation)
		2DTM	M1.4~M16	340	Thread Mills for Non-ferrous Metal 비철금속용 다기능 쓰레드밀
		4TRTM	Tr8~ Tr26	341	TR Thread Mills TR나사 쓰레드밀
		4TRTMS	Tr8~ Tr26	342	TR Thread Mills for SUS SUS용 TR나사 쓰레드밀
		4MTM	M1~M18	343	Thread Mills with One Thread 범용 다기능 쓰레드밀(1나사산)
		4MTMA	M1~M18	344	Thread Mills with One Thread for Aluminum 알루미늄용 쓰레드밀(1나사산)
		4MTMS	M1~M18	345	Thread Mills with One Thread for SUS SUS용 쓰레드밀(1나사산)
		4STM	M1~M20 UNC, UNF	346	Short Flute Thread Mills for Multi Purpose 범용 짧은 날 쓰레드밀
		4STMA	M1~M20 UNC, UNF	349	Short Flute Thread Mills for Aluminum 알루미늄용 짧은 날 쓰레드밀
		4STMS	M1~M20 UNC, UNF	352	Short Flute Thread Mills for SUS SUS용 짧은 날 쓰레드밀
		4BSP	1/16"~ 2 1/2"	355	Pipe Short Parallel Thread Mills for Multi Purpose 범용 파이프 짧은 날 평행 나사 가공
		4BSPA	1/16"~ 2 1/2"	356	Pipe Short Parallel Thread Mills for Aluminum 알루미늄 파이프 짧은 날 평행 나사 가공
		4BSPS	1/16"~ 2 1/2"	357	Pipe Short Parallel Thread Mill for SUS SUS 파이프 짧은 날 평행 나사 가공
		4HTM	M3~M16 UNC, UNF	358	Helix Thread Mills For Multi Purpose 범용 헬릭스 쓰레드밀
		4HTMA	M3~M16 UNC, UNF	360	Helix Thread Mills for Aluminum 알루미늄용 헬릭스 쓰레드밀
		4HTMS	M3~M16 UNC, UNF	362	Helix Thread Mills for SUS SUS용 헬릭스 쓰레드밀
		4HBSP	1/16"~ 2 1/2"	364	Pipe Parallel Thread Mills for Multi Purpose 범용 파이프 평행 나사 가공
		4HBSPA	1/16"~ 2 1/2"	365	Pipe Parallel Thread Mills for Aluminum 알루미늄 파이프 평행 나사 가공
		4HBSPS	1/16"~ 2 1/2"	366	Pipe Parallel Thread Mills for SUS SUS 파이프 평행 나사 가공
		4LTM	M3~M20 UNC, UNF, UNEF	367	Helix Long Thread Mills For Multi Purpose 범용 헬릭스 긴 길이 쓰레드밀
		4LTMA	M3~M20 UNC, UNF, UNEF	370	Helix Long Thread Mills for Aluminum 알루미늄용 헬릭스 긴 길이 쓰레드밀
		4LTMS	M3~M20 UNC, UNF, UNEF	373	Helix Long Thread Mills for SUS SUS용 헬릭스 긴 길이 쓰레드밀
		4NKTM	M3~M20	376	Helix Nick Type Thread Mills for Multi Purpose 범용 헬릭스 니크 타입 쓰레드밀
		4NKTMA	M3~M20	378	Helix Nick Type Thread Mills for Aluminum 알루미늄용 헬릭스 니크 타입 쓰레드밀
		4NKTMS	M3~M20	380	Helix Nick Type Thread Mills for SUS SUS용 헬릭스 니크 타입 쓰레드밀
		4BSPT	1/16"~2"	382	Pipe Taper Short Thread Mills for Multi Purpose 범용 파이프 짧은 날 테이퍼 나사 가공
		4BSPTA	1/16"~2"	383	Pipe Taper Short Thread Mills for Aluminum 알루미늄 파이프 짧은 날 테이퍼 나사 가공
		4BSPTS	1/16"~2"	384	Pipe Taper Short Thread Mills for SUS SUS 파이프 짧은 날 테이퍼 나사 가공
		4NPTS	1/16"~2"	385	Pipe Taper Short Thread Mills for Multi Purpose 범용 파이프 짧은 날 테이퍼 나사 가공
		4NPTSA	1/16"~2"	386	Pipe Taper Short Thread Mills for Aluminum 알루미늄 파이프 짧은 날 테이퍼 나사 가공
		4NPTSS	1/16"~2"	387	Pipe Taper Short Thread Mills for SUS SUS 파이프 짧은 날 테이퍼 나사 가공
		4BSTM	1/16"~2"	388	Pipe Taper Thread Mills for Multi Purpose 범용 파이프 테이퍼 나사 가공
		4BSTMA	1/16"~2"	389	Pipe Taper Thread Mills for Aluminum 알루미늄 파이프 테이퍼 나사 가공
		4BSTMS	1/16"~2"	390	Pipe Taper Thread Mills for SUS SUS 파이프 테이퍼 나사 가공
		4NPTM	1/16"~2"	391	Pipe Taper Thread Mills for Multi Purpose 범용 파이프 테이퍼 나사 가공
	4NPTMA	1/16"~2"	392	Pipe Taper Thread Mills for Aluminum 알루미늄 파이프 테이퍼 나사 가공	
	4NPTMS	1/16"~2"	393	Pipe Taper Thread Mills for SUS SUS 파이프 테이퍼 나사 가공	
	4IMTM	M1.2~M2.5	394	for Dental Implants (Three Thread) 치과 임플란트용(3나사산)	
	4IMTM	M0.8~M2.6	394	for Dental Implants (Three Thread) 치과 임플란트용(3나사산)	

프리하든강 Pre-hardened Steel	하든강 Hardened Steel ~ HRC55   HRC55~ 65		합금강/공구강 Alloy Steel Tool Steel	내열 합금강 Heat Resistance Alloy	티타늄 Titanium	스테인레스강 Stainless Steel	알루미늄 Aluminum	구리 Copper	탄소강 Carbon Steel	흑연 Graphite	복합소재 CFRP GFRP	A.B.S수지 Resin
							★	★				◎
◎			◎			★			◎			
							★	★				○
◎			★						★			
						★			○			
★	★	◎	★						★			
							★	★				◎
◎			◎	◎	◎	★			◎			
★	◎	○	★						★			
							★	★				◎
○			○	◎	★	★			○			
★	◎	○	◎						◎			
							★	★				◎
○			○	◎	★	★			○			
★	○		★						★			
							★	★				○
○			◎						◎			
★							★	★				◎
○							★	★				◎
○			◎						★			
○			◎						★			◎
○			○			★			○			
★	★	★	★						◎			
							★	★				◎
◎			◎	◎	★	★			◎			
★	◎	○	★						★			
							★	★				◎
○			○	◎	★	★			○			
★	◎	○	★						◎			
							★	★				◎
○			○	◎	★	★			○			
★	○		★						★			
							★	★				◎
○							★	★	○			
★	○		★						★			
							★	★				◎
○							★		○			
					★	◎						
					★	◎						





# 2SBCBN CBN, 2 Flutes High Speed Rib Ball End Mills

## 2날 CBN 고속가공용 직선날 리브 볼 엔드밀

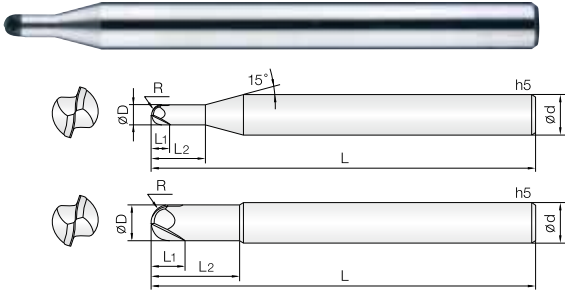

- 고경도강 (HRc50~72)의 고정밀 (±5μm) 정삭 가공용 엔드밀
- 고품질의 PCBN 소재를 적용하여 장시간 가공이 가능합니다.
- 날부 스트레이트 설계로 보다 높은 경면 상사가공에 적합합니다.
- 날부인선의 조도가 뛰어나 경면가공에 적합합니다.
- 오일미스트 사용을 권장하며, RPM 2만~5만 범위의 고속가공을 추천합니다.
- C.B.N (Cubic Boron Nitride)
- PCBN Endmills for precise finishing (±5μm) of hardened steels (HRc50~72)
- Long tool life by high content PCBN.
- The edge straight design is suitable for higher slope terrain machining.
- Excellent surface finish.
- Recommend high speed (20,000~50,000RPM) with oil-mist.
- C.B.N (Cubic Boron Nitride)

2
CBN
R ±0.005
R ±0.007
R ±0.01
0° Helix Angle
CUTTING DATA 401P

D Size	D Tolerance
Ø0.2 ~ 6	+0 ~ -0.01mm

단위 : mm

Order Number	날경 Diameter R × D	날장 Length of cut L1	유효장 Effective Length L2	전장 Overall Length L	샙크 Shank Dia d	비고
2SBCBN 002 002 S04	0.1R X 0.2	0.2	-	48	4	
2SBCBN 002 004 S04	0.1R X 0.2	0.4	-	48	4	
2SBCBN 003 003 S04	0.15R X 0.3	0.3	-	48	4	
2SBCBN 003 005 S04	0.15R X 0.3	0.5	-	48	4	
2SBCBN 004 003 S04	0.2R X 0.4	0.3	-	48	4	
2SBCBN 004 010 S04	0.2R X 0.4	0.3	1	48	4	
2SBCBN 004 015 S04	0.2R X 0.4	0.3	1.5	48	4	
2SBCBN 005 004 S04	0.25R X 0.5	0.4	-	48	4	
2SBCBN 005 010 S04	0.25R X 0.5	0.4	1	48	4	
2SBCBN 005 015 S04	0.25R X 0.5	0.4	1.5	48	4	
2SBCBN 005 020 S04	0.25R X 0.5	0.4	2	48	4	
2SBCBN 006 005 S04	0.3R X 0.6	0.5	-	48	4	
2SBCBN 006 010 S04	0.3R X 0.6	0.5	1	48	4	
2SBCBN 006 015 S04	0.3R X 0.6	0.5	1.5	48	4	
2SBCBN 006 020 S04	0.3R X 0.6	0.5	2	48	4	
2SBCBN 006 030 S04	0.3R X 0.6	0.5	3	48	4	
2SBCBN 006 040 S04	0.3R X 0.6	0.5	4	48	4	
2SBCBN 007 005 S04	0.35R X 0.7	0.5	-	48	4	
2SBCBN 007 010 S04	0.35R X 0.7	0.5	1	48	4	
2SBCBN 007 020 S04	0.35R X 0.7	0.5	2	48	4	
2SBCBN 008 006 S04	0.4R X 0.8	0.6	-	48	4	
2SBCBN 008 010 S04	0.4R X 0.8	0.6	1	48	4	
2SBCBN 008 020 S04	0.4R X 0.8	0.6	2	48	4	
2SBCBN 008 030 S04	0.4R X 0.8	0.6	3	48	4	
2SBCBN 008 040 S04	0.4R X 0.8	0.6	4	48	4	
2SBCBN 009 006 S04	0.45R X 0.9	0.6	-	48	4	
2SBCBN 009 010 S04	0.45R X 0.9	0.6	1	48	4	
2SBCBN 009 020 S04	0.45R X 0.9	0.6	2	48	4	
2SBCBN 010 007 S04	0.5R X 1	0.7	-	48	4	
2SBCBN 010 015 S04	0.5R X 1	0.7	1.5	48	4	
2SBCBN 010 025 S04	0.5R X 1	0.7	2.5	48	4	
2SBCBN 010 040 S04	0.5R X 1	0.7	4	48	4	
2SBCBN 010 050 S04	0.5R X 1	0.7	5	48	4	
2SBCBN 010 060 S04	0.5R X 1	0.7	6	48	4	
2SBCBN 012 008 S04	0.6R X 1.2	0.8	-	48	4	
2SBCBN 012 020 S04	0.6R X 1.2	0.8	2	48	4	
2SBCBN 012 040 S04	0.6R X 1.2	0.8	4	48	4	
2SBCBN 015 010 S04	0.75R X 1.5	1	-	48	4	
2SBCBN 015 020 S04	0.75R X 1.5	1	2	48	4	
2SBCBN 015 040 S04	0.75R X 1.5	1	4	48	4	
2SBCBN 015 060 S04	0.75R X 1.5	1	6	48	4	
2SBCBN 015 080 S04	0.75R X 1.5	1	8	48	4	
2SBCBN 015 100 S04	0.75R X 1.5	1	10	48	4	
2SBCBN 020 012 S04	1R X 2	1.2	-	50	4	
2SBCBN 020 030 S04	1R X 2	1.2	3	50	4	
2SBCBN 020 040 S04	1R X 2	1.2	4	50	4	
2SBCBN 020 060 S04	1R X 2	1.2	6	50	4	
2SBCBN 020 080 S04	1R X 2	1.2	8	50	4	
2SBCBN 020 100 S04	1R X 2	1.2	10	50	4	
2SBCBN 020 120 S04	1R X 2	1.2	12	50	4	



# 2ECBN CBN, 2 Flutes High Speed Rib End Mills

## 2날 CBN 고속가공용 리브 엔드밀

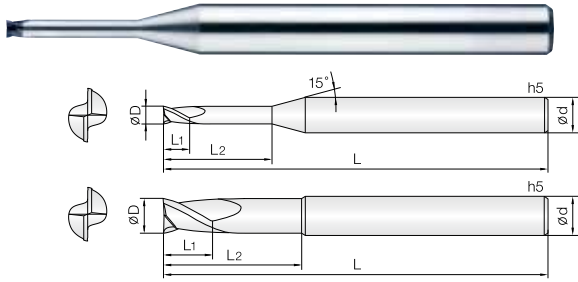

- 고경도강(HRc50~72)의 고정밀(±5μm) 정삭 가공용 엔드밀
- 고품질의 PCBN 소재를 적용하여 장시간 가공이 가능합니다.
- 다양한 유효장을 적용함으로써 최상의 작업이 가능합니다.
- 오일미스트 사용을 권장하며, RPM 2만~5만 범위의 고속가공을 추천합니다.
- C.B.N (Cubic Boron Nitride)

### PCBN Endmills for precise finishing (±5μm) of hardened steels (HRc50~72)

- Long tool life by high content PCBN.
- Excellent surface finish.
- Various flute length for optimum performance.
- Recommend high speed (20,000~50,000RPM) with oil-mist.
- C.B.N (Cubic Boron Nitride)

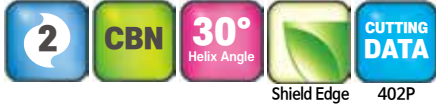

D Size	D Tolerance
ø0.2~6	+0 - -0.01mm

Order Number	날경 Diameter D	날장 Length of cut L1	유효장 Effective Length L2	전장 Overall Length L	생크 Shank Dia d	비고	Order Number	날경 Diameter D	날장 Length of cut L1	유효장 Effective Length L2	전장 Overall Length L	생크 Shank Dia d	비고
2ECBN 002 002 S04	0.2	0.2	-	48	4		2ECBN 010 015 S04	1	0.7	1.5	48	4	
2ECBN 002 004 S04	0.2	0.4	-	48	4		2ECBN 010 025 S04	1	0.7	2.5	48	4	
2ECBN 003 003 S04	0.3	0.3	-	48	4		2ECBN 010 040 S04	1	0.7	4	48	4	
2ECBN 003 005 S04	0.3	0.5	-	48	4		2ECBN 010 050 S04	1	0.7	5	48	4	
2ECBN 004 003 S04	0.4	0.3	-	48	4		2ECBN 010 060 S04	1	0.7	6	48	4	
2ECBN 004 010 S04	0.4	0.3	1	48	4		2ECBN 010 080 S04	1	0.7	8	48	4	
2ECBN 004 015 S04	0.4	0.3	1.5	48	4		2ECBN 010 100 S04	1	0.7	10	48	4	
2ECBN 004 020 S04	0.4	0.3	2	48	4		2ECBN 010 120 S04	1	0.7	12	48	4	
2ECBN 004 030 S04	0.4	0.3	3	48	4		2ECBN 010 140 S04	1	0.7	14	48	4	
2ECBN 004 040 S04	0.4	0.3	4	48	4		2ECBN 010 160 S04	1	0.7	16	48	4	
2ECBN 004 050 S04	0.4	0.3	5	48	4		2ECBN 012 007 S04	1.2	0.7	-	48	4	
2ECBN 004 060 S04	0.4	0.3	6	48	4		2ECBN 012 015 S04	1.2	0.7	1.5	48	4	
2ECBN 005 004 S04	0.5	0.4	-	48	4		2ECBN 012 030 S04	1.2	0.7	3	48	4	
2ECBN 005 010 S04	0.5	0.4	1	48	4		2ECBN 012 040 S04	1.2	0.7	4	48	4	
2ECBN 005 015 S04	0.5	0.4	1.5	48	4		2ECBN 012 060 S04	1.2	0.7	6	48	4	
2ECBN 005 020 S04	0.5	0.4	2	48	4		2ECBN 012 080 S04	1.2	0.7	8	48	4	
2ECBN 005 030 S04	0.5	0.4	3	48	4		2ECBN 012 100 S04	1.2	0.7	10	48	4	
2ECBN 005 040 S04	0.5	0.4	4	48	4		2ECBN 012 120 S04	1.2	0.7	12	48	4	
2ECBN 005 050 S04	0.5	0.4	5	48	4		2ECBN 012 160 S04	1.2	0.7	16	48	4	
2ECBN 005 060 S04	0.5	0.4	6	48	4		2ECBN 015 008 S04	1.5	0.8	-	48	4	
2ECBN 005 080 S04	0.5	0.4	8	48	4		2ECBN 015 015 S04	1.5	0.8	1.5	48	4	
2ECBN 006 005 S04	0.6	0.5	-	48	4		2ECBN 015 030 S04	1.5	0.8	3	48	4	
2ECBN 006 010 S04	0.6	0.5	1	48	4		2ECBN 015 060 S04	1.5	0.8	6	48	4	
2ECBN 006 015 S04	0.6	0.5	1.5	48	4		2ECBN 015 080 S04	1.5	0.8	8	48	4	
2ECBN 006 020 S04	0.6	0.5	2	48	4		2ECBN 015 100 S04	1.5	0.8	10	48	4	
2ECBN 006 030 S04	0.6	0.5	3	48	4		2ECBN 015 120 S04	1.5	0.8	12	48	4	
2ECBN 006 040 S04	0.6	0.5	4	48	4		2ECBN 015 140 S04	1.5	0.8	14	48	4	
2ECBN 006 060 S04	0.6	0.5	6	48	4		2ECBN 015 160 S04	1.5	0.8	16	48	4	
2ECBN 006 080 S04	0.6	0.5	8	48	4		2ECBN 015 180 S04	1.5	0.8	18	48	4	
2ECBN 006 100 S04	0.6	0.5	10	48	4		2ECBN 020 009 S04	2	0.9	-	50	4	
2ECBN 007 005 S04	0.7	0.5	-	48	4		2ECBN 020 020 S04	2	0.9	2	50	4	
2ECBN 007 015 S04	0.7	0.5	1.5	48	4		2ECBN 020 030 S04	2	0.9	3	50	4	
2ECBN 007 025 S04	0.7	0.5	2.5	48	4		2ECBN 020 060 S04	2	0.9	6	50	4	
2ECBN 007 040 S04	0.7	0.5	4	48	4		2ECBN 020 080 S04	2	0.9	8	50	4	
2ECBN 007 060 S04	0.7	0.5	6	48	4		2ECBN 020 100 S04	2	0.9	10	50	4	
2ECBN 008 006 S04	0.8	0.6	-	48	4		2ECBN 020 120 S04	2	0.9	12	50	4	
2ECBN 008 015 S04	0.8	0.6	1.5	48	4		2ECBN 020 140 S04	2	0.9	14	50	4	
2ECBN 008 025 S04	0.8	0.6	2.5	48	4		2ECBN 020 160 S04	2	0.9	16	50	4	
2ECBN 008 040 S04	0.8	0.6	4	48	4		2ECBN 020 180 S04	2	0.9	18	50	4	
2ECBN 008 060 S04	0.8	0.6	6	48	4		2ECBN 025 012 S06	2.5	1.2	-	66	6	
2ECBN 008 080 S04	0.8	0.6	8	48	4		2ECBN 025 030 S06	2.5	1.2	3	66	6	
2ECBN 008 100 S04	0.8	0.6	10	48	4		2ECBN 025 060 S06	2.5	1.2	6	66	6	
2ECBN 009 006 S04	0.9	0.6	-	48	4		2ECBN 025 100 S06	2.5	1.2	10	66	6	
2ECBN 009 015 S04	0.9	0.6	1.5	48	4		2ECBN 025 160 S06	2.5	1.2	16	66	6	
2ECBN 009 025 S04	0.9	0.6	2.5	48	4		2ECBN 025 200 S06	2.5	1.2	20	66	6	
2ECBN 009 040 S04	0.9	0.6	4	48	4		2ECBN 030 012 S06	3	1.2	-	66	6	
2ECBN 009 060 S04	0.9	0.6	6	48	4		2ECBN 030 030 S06	3	1.2	3	66	6	
2ECBN 009 080 S04	0.9	0.6	8	48	4		2ECBN 030 060 S06	3	1.2	6	66	6	
2ECBN 009 100 S04	0.9	0.6	10	48	4		2ECBN 030 080 S06	3	1.2	8	66	6	
2ECBN 010 007 S04	1	0.7	-	48	4		2ECBN 030 100 S06	3	1.2	10	66	6	

# 2ECBN CBN, 2 Flutes High Speed Rib End Mills

## 2날 CBN 고속가공용 리브 엔드밀

단위: mm

Order Number	날경 Diameter D	날장 Length of cut L1	유효장 Effective Length L2	전장 Overall Length L	샙크 Dia d	비고	Order Number	날경 Diameter D	날장 Length of cut L1	유효장 Effective Length L2	전장 Overall Length L	샙크 Dia d	비고
2ECBN 030 120 S06	3	1.2	12	66	6								
2ECBN 030 160 S06	3	1.2	16	66	6								
2ECBN 030 200 S06	3	1.2	20	66	6								
2ECBN 040 015 S06	4	1.5	-	66	6								
2ECBN 040 030 S06	4	1.5	3	66	6								
2ECBN 040 060 S06	4	1.5	6	66	6								
2ECBN 040 080 S06	4	1.5	8	66	6								
2ECBN 040 100 S06	4	1.5	10	66	6								
2ECBN 040 120 S06	4	1.5	12	66	6								
2ECBN 040 160 S06	4	1.5	16	66	6								
2ECBN 040 200 S06	4	1.5	20	66	6								
2ECBN 060 030 S06	6	3	-	83	6								
2ECBN 060 100 S06	6	3	10	83	6								
2ECBN 060 200 S06	6	3	20	83	6								

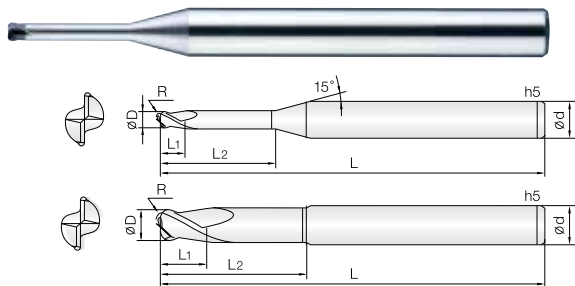

- 고정도강(HRc50~72)의 고정밀(±5μm) 정삭 가공용 엔드밀
- 고품량의 PCBN 소재를 적용하여 장시간 가공이 가능합니다.
- 날부인선의 조도가 뛰어나 경면가공에 적합 합니다.
- 다양한 유효장을 적용함으로써 최상의 작업이 가능합니다.
- 오일미스트 사용을 권장하며, RPM 2만~5만 범위의 고속가공을 추천합니다.
- C.B.N (Cubic Boron Nitride)

• PCBN Endmills for precise finishing (±5μm) of hardened steel (HRc50~72)

- Long tool life by high content PCBN.
- Excellent surface finish.
- Various flute length for optimum performance.
- Recommend high speed (20,000~50,000RPM) with oil-mist.
- C.B.N (Cubic Boron Nitride)



R0.02 ~ 1

403P

D Size	D Tolerance
Ø0.2 ~ 6	+0 - -0.01mm

단위 : mm

Order Number	날경 Diameter D×R	날장 Length of cut L1	유효장 Effective Length L2	전장 Overall Length L	생크 Shank Dia d	비고	Order Number	날경 Diameter D×R	날장 Length of cut L1	유효장 Effective Length L2	전장 Overall Length L	생크 Shank Dia d	비고
2CCBN 002 0002 002	0.2 X R0.02	0.2	-	48	4		2CCBN 008 002 060	0.8 X R0.2	0.6	6	48	4	
2CCBN 002 0002 004	0.2 X R0.02	0.4	-	48	4		2CCBN 010 0002 007	1 X R0.02	0.7	-	48	4	
2CCBN 002 0005 002	0.2 X R0.05	0.2	-	48	4		2CCBN 010 0002 015	1 X R0.02	0.7	1.5	48	4	
2CCBN 002 0005 004	0.2 X R0.05	0.4	-	48	4		2CCBN 010 0002 025	1 X R0.02	0.7	2.5	48	4	
2CCBN 003 0002 003	0.3 X R0.02	0.3	-	48	4		2CCBN 010 0002 040	1 X R0.02	0.7	4	48	4	
2CCBN 003 0002 005	0.3 X R0.02	0.5	-	48	4		2CCBN 010 0002 060	1 X R0.02	0.7	6	48	4	
2CCBN 003 0005 003	0.3 X R0.05	0.3	-	48	4		2CCBN 010 0002 080	1 X R0.02	0.7	8	48	4	
2CCBN 003 0005 005	0.3 X R0.05	0.5	-	48	4		2CCBN 010 0002 100	1 X R0.02	0.7	10	48	4	
2CCBN 004 0002 003	0.4 X R0.02	0.3	-	48	4		2CCBN 010 0005 007	1 X R0.05	0.7	-	48	4	
2CCBN 004 0002 015	0.4 X R0.02	0.3	1.5	48	4		2CCBN 010 0005 015	1 X R0.05	0.7	1.5	48	4	
2CCBN 004 0002 020	0.4 X R0.02	0.3	2	48	4		2CCBN 010 0005 025	1 X R0.05	0.7	2.5	48	4	
2CCBN 004 0005 003	0.4 X R0.05	0.3	-	48	4		2CCBN 010 0005 040	1 X R0.05	0.7	4	48	4	
2CCBN 004 0005 015	0.4 X R0.05	0.3	1.5	48	4		2CCBN 010 0005 060	1 X R0.05	0.7	6	48	4	
2CCBN 004 0005 020	0.4 X R0.05	0.3	2	48	4		2CCBN 010 0005 080	1 X R0.05	0.7	8	48	4	
2CCBN 004 001 003	0.4 X R0.1	0.3	-	48	4		2CCBN 010 0005 100	1 X R0.05	0.7	10	48	4	
2CCBN 004 001 015	0.4 X R0.1	0.3	1.5	48	4		2CCBN 010 001 007	1 X R0.1	0.7	-	48	4	
2CCBN 004 001 020	0.4 X R0.1	0.3	2	48	4		2CCBN 010 001 015	1 X R0.1	0.7	1.5	48	4	
2CCBN 005 0005 004	0.5 X R0.05	0.4	-	48	4		2CCBN 010 001 025	1 X R0.1	0.7	2.5	48	4	
2CCBN 005 0005 015	0.5 X R0.05	0.4	1.5	48	4		2CCBN 010 001 040	1 X R0.1	0.7	4	48	4	
2CCBN 005 0005 020	0.5 X R0.05	0.4	2	48	4		2CCBN 010 001 060	1 X R0.1	0.7	6	48	4	
2CCBN 005 0005 030	0.5 X R0.05	0.4	3	48	4		2CCBN 010 001 080	1 X R0.1	0.7	8	48	4	
2CCBN 005 0005 040	0.5 X R0.05	0.4	4	48	4		2CCBN 010 001 100	1 X R0.1	0.7	10	48	4	
2CCBN 005 0005 050	0.5 X R0.05	0.4	5	48	4		2CCBN 010 002 007	1 X R0.2	0.7	-	48	4	
2CCBN 005 001 004	0.5 X R0.1	0.4	-	48	4		2CCBN 010 002 015	1 X R0.2	0.7	1.5	48	4	
2CCBN 005 001 015	0.5 X R0.1	0.4	1.5	48	4		2CCBN 010 002 025	1 X R0.2	0.7	2.5	48	4	
2CCBN 005 001 020	0.5 X R0.1	0.4	2	48	4		2CCBN 010 002 040	1 X R0.2	0.7	4	48	4	
2CCBN 005 001 030	0.5 X R0.1	0.4	3	48	4		2CCBN 010 002 060	1 X R0.2	0.7	6	48	4	
2CCBN 005 001 040	0.5 X R0.1	0.4	4	48	4		2CCBN 010 002 080	1 X R0.2	0.7	8	48	4	
2CCBN 005 001 050	0.5 X R0.1	0.4	5	48	4		2CCBN 010 002 100	1 X R0.2	0.7	10	48	4	
2CCBN 006 0005 005	0.6 X R0.05	0.5	-	48	4		2CCBN 010 003 007	1 X R0.3	0.7	-	48	4	
2CCBN 006 0005 020	0.6 X R0.05	0.5	2	48	4		2CCBN 010 003 015	1 X R0.3	0.7	1.5	48	4	
2CCBN 006 0005 030	0.6 X R0.05	0.5	3	48	4		2CCBN 010 003 025	1 X R0.3	0.7	2.5	48	4	
2CCBN 006 0005 040	0.6 X R0.05	0.5	4	48	4		2CCBN 010 003 040	1 X R0.3	0.7	4	48	4	
2CCBN 006 0005 060	0.6 X R0.05	0.5	6	48	4		2CCBN 010 003 060	1 X R0.3	0.7	6	48	4	
2CCBN 006 001 005	0.6 X R0.1	0.5	-	48	4		2CCBN 010 003 080	1 X R0.3	0.7	8	48	4	
2CCBN 006 001 020	0.6 X R0.1	0.5	2	48	4		2CCBN 010 003 100	1 X R0.3	0.7	10	48	4	
2CCBN 006 001 030	0.6 X R0.1	0.5	3	48	4		2CCBN 012 001 007	1.2 X R0.1	0.7	-	48	4	
2CCBN 006 001 040	0.6 X R0.1	0.5	4	48	4		2CCBN 012 001 015	1.2 X R0.1	0.7	1.5	48	4	
2CCBN 006 001 060	0.6 X R0.1	0.5	6	48	4		2CCBN 012 001 030	1.2 X R0.1	0.7	3	48	4	
2CCBN 007 001 005	0.7 X R0.1	0.5	-	48	4		2CCBN 012 001 040	1.2 X R0.1	0.7	4	48	4	
2CCBN 007 001 025	0.7 X R0.1	0.5	2.5	48	4		2CCBN 012 001 060	1.2 X R0.1	0.7	6	48	4	
2CCBN 007 001 040	0.7 X R0.1	0.5	4	48	4		2CCBN 012 001 080	1.2 X R0.1	0.7	8	48	4	
2CCBN 007 001 060	0.7 X R0.1	0.5	6	48	4		2CCBN 012 001 100	1.2 X R0.1	0.7	10	48	4	
2CCBN 008 001 006	0.8 X R0.1	0.6	-	48	4		2CCBN 012 002 007	1.2 X R0.2	0.7	-	48	4	
2CCBN 008 001 025	0.8 X R0.1	0.6	2.5	48	4		2CCBN 012 002 015	1.2 X R0.2	0.7	1.5	48	4	
2CCBN 008 001 040	0.8 X R0.1	0.6	4	48	4		2CCBN 012 002 030	1.2 X R0.2	0.7	3	48	4	
2CCBN 008 001 060	0.8 X R0.1	0.6	6	48	4		2CCBN 012 002 040	1.2 X R0.2	0.7	4	48	4	
2CCBN 008 002 006	0.8 X R0.2	0.6	-	48	4		2CCBN 012 002 060	1.2 X R0.2	0.7	6	48	4	
2CCBN 008 002 025	0.8 X R0.2	0.6	2.5	48	4		2CCBN 012 002 080	1.2 X R0.2	0.7	8	48	4	
2CCBN 008 002 040	0.8 X R0.2	0.6	4	48	4		2CCBN 012 002 100	1.2 X R0.2	0.7	10	48	4	



단위: mm

Order Number	날경 Diameter D × R	날장 Length of cut L1	유효장 Effective Length L2	전장 Overall Length L	생크 Shank Dia d	비고	Order Number	날경 Diameter D × R	날장 Length of cut L1	유효장 Effective Length L2	전장 Overall Length L	생크 Shank Dia d	비고
2CCBN 040 002 100	4 X R0.2	1.5	10	66	6								
2CCBN 040 002 160	4 X R0.2	1.5	16	66	6								
2CCBN 040 003 015	4 X R0.3	1.5	-	66	6								
2CCBN 040 003 030	4 X R0.3	1.5	3	66	6								
2CCBN 040 003 060	4 X R0.3	1.5	6	66	6								
2CCBN 040 003 100	4 X R0.3	1.5	10	66	6								
2CCBN 040 003 160	4 X R0.3	1.5	16	66	6								
2CCBN 040 005 015	4 X R0.5	1.5	-	66	6								
2CCBN 040 005 030	4 X R0.5	1.5	3	66	6								
2CCBN 040 005 060	4 X R0.5	1.5	6	66	6								
2CCBN 040 005 100	4 X R0.5	1.5	10	66	6								
2CCBN 040 005 160	4 X R0.5	1.5	16	66	6								
2CCBN 040 010 015	4 X R1	1.5	-	66	6								
2CCBN 040 010 030	4 X R1	1.5	3	66	6								
2CCBN 040 010 060	4 X R1	1.5	6	66	6								
2CCBN 040 010 100	4 X R1	1.5	10	66	6								
2CCBN 040 010 160	4 X R1	1.5	16	66	6								
2CCBN 060 003 030	6 X R0.3	3	-	83	6								
2CCBN 060 003 150	6 X R0.3	3	15	83	6								
2CCBN 060 005 030	6 X R0.5	3	-	83	6								
2CCBN 060 005 150	6 X R0.5	3	15	83	6								
2CCBN 060 010 030	6 X R1	3	-	83	6								
2CCBN 060 010 150	6 X R1	3	15	83	6								

# 2SCCBN CBN, 2 Flutes High Speed Straight Rib Corner Radius End Mills

## 2날 CBN 고속가공용 직선날 리브 코너 레디우스 엔드밀

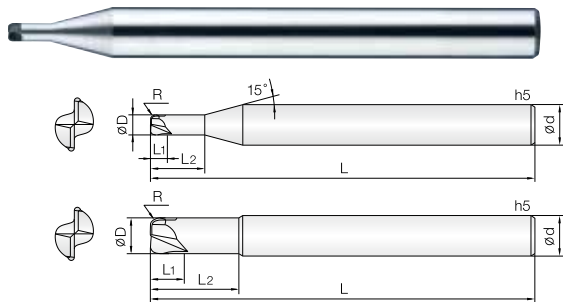

- 고경도강(HRc50~72)의 고정밀(±5μm) 정삭 가공용 엔드밀
- 고함량의 PCBN 소재를 적용하여 장시간 가공이 가능합니다.
- 날부 스트레이트 타입 형상으로 치핑을 더욱 최소화 하였습니다.
- 날부인선의 조도가 뛰어나 경면가공에 적합 합니다.
- 다양한 유효장을 적용함으로써 최상의 작업이 가능합니다.
- 오일미스트 사용을 권장하며, RPM 2만~5만 범위의 고속가공을 추천합니다.
- C.B.N (Cubic Boron Nitride)

### PCBN Endmills for precise finishing (±5μm) of hardened steels (HRc50~72)

- Long tool life by high content PCBN.
- Straight type Design for Minimizing edge chipping.
- Excellent surface finish.
- Various flute length for optimum performance.
- Recommend high speed (20,000~50,000RPM) with oil-mist.
- C.B.N (Cubic Boron Nitride)



D Size	D Tolerance
Ø 0.4 ~ 6	+0 -0.01mm

단위 : mm

Order Number	날경 Diameter D×R	날장 Length of cut L1	유효장 Effective Length L2	전장 Overall Length L	샙크 Shank Dia d	비고	Order Number	날경 Diameter D×R	날장 Length of cut L1	유효장 Effective Length L2	전장 Overall Length L	샙크 Shank Dia d	비고
New 2SCCBN 004 0002 003	0.4 X R0.02	0.3	-	48	4		2SCCBN 020 0002 060	2 X R0.02	0.9	6	50	4	
2SCCBN 004 0002 015	0.4 X R0.02	0.3	1.5	48	4		New 2SCCBN 020 0005 009	2 X R0.05	0.9	-	50	4	
New 2SCCBN 004 0005 003	0.4 X R0.05	0.3	-	48	4		2SCCBN 020 0005 030	2 X R0.05	0.9	3	50	4	
2SCCBN 004 0005 015	0.4 X R0.05	0.3	1.5	48	4		2SCCBN 020 0005 060	2 X R0.05	0.9	6	50	4	
New 2SCCBN 004 001 003	0.4 X R0.1	0.3	-	48	4		New 2SCCBN 020 001 009	2 X R0.1	0.9	-	50	4	
2SCCBN 004 001 015	0.4 X R0.1	0.3	1.5	48	4		2SCCBN 020 001 030	2 X R0.1	0.9	3	50	4	
New 2SCCBN 005 0005 004	0.5 X R0.05	0.4	-	48	4		2SCCBN 020 001 060	2 X R0.1	0.9	6	50	4	
2SCCBN 005 0005 015	0.5 X R0.05	0.4	1.5	48	4		New 2SCCBN 020 002 009	2 X R0.2	0.9	-	50	4	
New 2SCCBN 005 001 004	0.5 X R0.1	0.4	-	48	4		2SCCBN 020 002 030	2 X R0.2	0.9	3	50	4	
2SCCBN 005 001 015	0.5 X R0.1	0.4	1.5	48	4		2SCCBN 020 002 060	2 X R0.2	0.9	6	50	4	
New 2SCCBN 006 0005 005	0.6 X R0.05	0.5	-	48	4		New 2SCCBN 020 003 009	2 X R0.3	0.9	-	50	4	
2SCCBN 006 0005 020	0.6 X R0.05	0.5	2	48	4		2SCCBN 020 003 030	2 X R0.3	0.9	3	50	4	
New 2SCCBN 006 001 005	0.6 X R0.1	0.5	-	48	4		2SCCBN 020 003 060	2 X R0.3	0.9	6	50	4	
2SCCBN 006 001 020	0.6 X R0.1	0.5	2	48	4		New 2SCCBN 020 005 009	2 X R0.5	0.9	-	50	4	
New 2SCCBN 008 001 006	0.8 X R0.1	0.6	-	48	4		2SCCBN 020 005 030	2 X R0.5	0.9	3	50	4	
2SCCBN 008 001 020	0.8 X R0.1	0.6	2	48	4		2SCCBN 020 005 060	2 X R0.5	0.9	6	50	4	
New 2SCCBN 008 002 006	0.8 X R0.2	0.6	-	48	4		New 2SCCBN 025 001 012	2.5 X R0.1	1.2	-	66	6	
2SCCBN 008 002 020	0.8 X R0.2	0.6	2	48	4		2SCCBN 025 001 060	2.5 X R0.1	1.2	6	66	6	
New 2SCCBN 010 0002 007	1 X R0.02	0.7	-	48	4		New 2SCCBN 025 002 012	2.5 X R0.2	1.2	-	66	6	
2SCCBN 010 0002 025	1 X R0.02	0.7	2.5	48	4		2SCCBN 025 002 060	2.5 X R0.2	1.2	6	66	6	
2SCCBN 010 0002 040	1 X R0.02	0.7	4	48	4		New 2SCCBN 025 003 012	2.5 X R0.3	1.2	-	66	6	
New 2SCCBN 010 0005 007	1 X R0.05	0.7	-	48	4		2SCCBN 025 003 060	2.5 X R0.3	1.2	6	66	6	
2SCCBN 010 0005 025	1 X R0.05	0.7	2.5	48	4		New 2SCCBN 030 001 012	3 X R0.1	1.2	-	66	6	
2SCCBN 010 0005 040	1 X R0.05	0.7	4	48	4		2SCCBN 030 001 060	3 X R0.1	1.2	6	66	6	
New 2SCCBN 010 001 007	1 X R0.1	0.7	-	48	4		2SCCBN 030 001 100	3 X R0.1	1.2	10	66	6	
2SCCBN 010 001 025	1 X R0.1	0.7	2.5	48	4		New 2SCCBN 030 002 012	3 X R0.2	1.2	-	66	6	
2SCCBN 010 001 040	1 X R0.1	0.7	4	48	4		2SCCBN 030 002 060	3 X R0.2	1.2	6	66	6	
New 2SCCBN 010 002 007	1 X R0.2	0.7	-	48	4		2SCCBN 030 002 100	3 X R0.2	1.2	10	66	6	
2SCCBN 010 002 025	1 X R0.2	0.7	2.5	48	4		New 2SCCBN 030 003 012	3 X R0.3	1.2	-	66	6	
2SCCBN 010 002 040	1 X R0.2	0.7	4	48	4		2SCCBN 030 003 060	3 X R0.3	1.2	6	66	6	
New 2SCCBN 010 003 007	1 X R0.3	0.7	-	48	4		2SCCBN 030 003 100	3 X R0.3	1.2	10	66	6	
2SCCBN 010 003 025	1 X R0.3	0.7	2.5	48	4		New 2SCCBN 030 005 012	3 X R0.5	1.2	-	66	6	
2SCCBN 010 003 040	1 X R0.3	0.7	4	48	4		2SCCBN 030 005 060	3 X R0.5	1.2	6	66	6	
New 2SCCBN 015 0002 008	1.5 X R0.02	0.8	-	48	4		2SCCBN 030 005 100	3 X R0.5	1.2	10	66	6	
2SCCBN 015 0002 030	1.5 X R0.02	0.8	3	48	4		2SCCBN 030 005 160	3 X R0.5	1.2	16	66	6	
2SCCBN 015 0002 040	1.5 X R0.02	0.8	4	48	4		New 2SCCBN 030 010 012	3 X R1	1.2	-	66	6	
New 2SCCBN 015 0005 008	1.5 X R0.05	0.8	-	48	4		2SCCBN 030 010 060	3 X R1	1.2	6	66	6	
2SCCBN 015 0005 030	1.5 X R0.05	0.8	3	48	4		2SCCBN 030 010 100	3 X R1	1.2	10	66	6	
2SCCBN 015 0005 040	1.5 X R0.05	0.8	4	48	4		2SCCBN 030 010 160	3 X R1	1.2	16	66	6	
New 2SCCBN 015 001 008	1.5 X R0.1	0.8	-	48	4		New 2SCCBN 040 001 015	4 X R0.1	1.5	-	66	6	
2SCCBN 015 001 030	1.5 X R0.1	0.8	3	48	4		2SCCBN 040 001 060	4 X R0.1	1.5	6	66	6	
2SCCBN 015 001 040	1.5 X R0.1	0.8	4	48	4		2SCCBN 040 001 100	4 X R0.1	1.5	10	66	6	
New 2SCCBN 015 002 008	1.5 X R0.2	0.8	-	48	4		2SCCBN 040 001 160	4 X R0.1	1.5	16	66	6	
2SCCBN 015 002 030	1.5 X R0.2	0.8	3	48	4		New 2SCCBN 040 002 015	4 X R0.2	1.5	-	66	6	
2SCCBN 015 002 040	1.5 X R0.2	0.8	4	48	4		2SCCBN 040 002 060	4 X R0.2	1.5	6	66	6	
New 2SCCBN 015 003 008	1.5 X R0.3	0.8	-	48	4		2SCCBN 040 002 100	4 X R0.2	1.5	10	66	6	
2SCCBN 015 003 030	1.5 X R0.3	0.8	3	48	4		2SCCBN 040 002 160	4 X R0.2	1.5	16	66	6	
2SCCBN 015 003 040	1.5 X R0.3	0.8	4	48	4		New 2SCCBN 040 003 015	4 X R0.3	1.5	-	66	6	
New 2SCCBN 020 0002 009	2 X R0.02	0.9	-	50	4		2SCCBN 040 003 060	4 X R0.3	1.5	6	66	6	
2SCCBN 020 0002 030	2 X R0.02	0.9	3	50	4		2SCCBN 040 003 100	4 X R0.3	1.5	10	66	6	

단위 : mm

Order Number	날경 Diameter R × D	날장 Length of cut L1	유효장 Effective Length L2	전장 Overall Length L	샤홅크 Shank Dia d	비고	Order Number	날경 Diameter R × D	날장 Length of cut L1	유효장 Effective Length L2	전장 Overall Length L	샤홅크 Shank Dia d	비고
2SCCBN 040 003 160	4 X R0.3	1.5	16	66	6								
New 2SCCBN 040 005 015	4 X R0.5	1.5	-	66	6								
2SCCBN 040 005 060	4 X R0.5	1.5	6	66	6								
2SCCBN 040 005 100	4 X R0.5	1.5	10	66	6								
2SCCBN 040 005 160	4 X R0.5	1.5	16	66	6								
New 2SCCBN 040 010 015	4 X R1	1.5	-	66	6								
2SCCBN 040 010 060	4 X R1	1.5	6	66	6								
2SCCBN 040 010 100	4 X R1	1.5	10	66	6								
2SCCBN 040 010 160	4 X R1	1.5	16	66	6								
2SCCBN 060 003 030	6 X R0.3	3	-	83	6								
2SCCBN 060 003 150	6 X R0.3	3	15	83	6								
2SCCBN 060 005 030	6 X R0.5	3	-	83	6								
2SCCBN 060 005 150	6 X R0.5	3	15	83	6								
2SCCBN 060 010 030	6 X R1	3	-	83	6								
2SCCBN 060 010 150	6 X R1	3	15	83	6								

# 4SCCBN

CBN, 4 Flutes High Speed Straight Rib Corner Radius End Mills

## 4날 CBN 고속가공용 직선날 리브 코너 레디우스 엔드밀

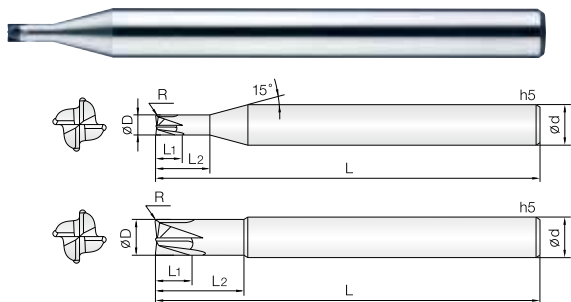

- 고경도강(HRc50~72)의 고정밀(±5μm) 정삭 가공용 엔드밀
- 고함량의 PCBN 소재를 적용하여 장시간가공이 가능합니다.
- 날부 스트레이트 타입 형상으로 치핑을 더욱 최소화 하였습니다.
- 날부인선의 조도가 뛰어나 경면가공에 적합합니다.
- 오일미스트 사용을 권장하며, RPM 2만~5만 범위의 고속가공을 추천합니다
- C.B.N (Cubic Boron Nitride)

### • PCBN Endmills for precise finishing (±5μm) of hardened steels (HRc50~72)

- Long tool life by high content PCBN.
- Straight type Design for Minimizing edge chipping.
- Excellent surface finish.
- Recommend high speed (20,000~50,000RPM) with oil-mist.
- C.B.N (Cubic Boron Nitride)



D Size	D Tolerance
Ø 0.8 - 6	+0 - -0.01mm

단위 : mm

Order Number	날경 Diameter D × R	날장 Length of cut L1	유효장 Effective Length L2	전장 Overall Length L	샙크 Shank Dia d	비고	Order Number	날경 Diameter D × R	날장 Length of cut L1	유효장 Effective Length L2	전장 Overall Length L	샙크 Shank Dia d	비고
New 4SCCBN 008 001 006	0.8 X R0.1	0.6	-	48	4		New 4SCCBN 020 003 009	2 X R0.3	0.9	-	50	4	
4SCCBN 008 001 025	0.8 X R0.1	0.6	2.5	48	4		4SCCBN 020 003 030	2 X R0.3	0.9	3	50	4	
New 4SCCBN 008 002 006	0.8 X R0.2	0.6	-	48	4		4SCCBN 020 003 040	2 X R0.3	0.9	4	50	4	
4SCCBN 008 002 025	0.8 X R0.2	0.6	2.5	48	4		4SCCBN 020 003 060	2 X R0.3	0.9	6	50	4	
New 4SCCBN 010 0002 007	1 X R0.02	0.7	-	48	4		New 4SCCBN 020 005 009	2 X R0.5	0.9	-	50	4	
4SCCBN 010 0002 025	1 X R0.02	0.7	2.5	48	4		4SCCBN 020 005 030	2 X R0.5	0.9	3	50	4	
4SCCBN 010 0002 040	1 X R0.02	0.7	4	48	4		4SCCBN 020 005 040	2 X R0.5	0.9	4	50	4	
New 4SCCBN 010 0005 007	1 X R0.05	0.7	-	48	4		4SCCBN 020 005 060	2 X R0.5	0.9	6	50	4	
4SCCBN 010 0005 025	1 X R0.05	0.7	2.5	48	4		New 4SCCBN 025 001 012	2.5 X R0.1	1.2	-	66	6	
4SCCBN 010 0005 040	1 X R0.05	0.7	4	48	4		4SCCBN 025 001 060	2.5 X R0.1	1.2	6	66	6	
New 4SCCBN 010 001 007	1 X R0.1	0.7	-	48	4		New 4SCCBN 025 002 012	2.5 X R0.2	1.2	-	66	6	
4SCCBN 010 001 025	1 X R0.1	0.7	2.5	48	4		4SCCBN 025 002 060	2.5 X R0.2	1.2	6	66	6	
4SCCBN 010 001 040	1 X R0.1	0.7	4	48	4		New 4SCCBN 025 003 012	2.5 X R0.3	1.2	-	66	6	
New 4SCCBN 010 002 007	1 X R0.2	0.7	-	48	4		4SCCBN 025 003 060	2.5 X R0.3	1.2	6	66	6	
4SCCBN 010 002 025	1 X R0.2	0.7	2.5	48	4		New 4SCCBN 030 001 012	3 X R0.1	1.2	-	66	6	
4SCCBN 010 002 040	1 X R0.2	0.7	4	48	4		4SCCBN 030 001 060	3 X R0.1	1.2	6	66	6	
New 4SCCBN 010 003 007	1 X R0.3	0.7	-	48	4		4SCCBN 030 001 100	3 X R0.1	1.2	10	66	6	
4SCCBN 010 003 025	1 X R0.3	0.7	2.5	48	4		New 4SCCBN 030 002 012	3 X R0.2	1.2	-	66	6	
4SCCBN 010 003 040	1 X R0.3	0.7	4	48	4		4SCCBN 030 002 060	3 X R0.2	1.2	6	66	6	
New 4SCCBN 015 0002 008	1.5 X R0.02	0.8	-	48	4		4SCCBN 030 002 100	3 X R0.2	1.2	10	66	6	
4SCCBN 015 0002 030	1.5 X R0.02	0.8	3	48	4		New 4SCCBN 030 003 012	3 X R0.3	1.2	-	66	6	
4SCCBN 015 0002 040	1.5 X R0.02	0.8	4	48	4		4SCCBN 030 003 060	3 X R0.3	1.2	6	66	6	
New 4SCCBN 015 0005 008	1.5 X R0.05	0.8	-	48	4		4SCCBN 030 003 100	3 X R0.3	1.2	10	66	6	
4SCCBN 015 0005 030	1.5 X R0.05	0.8	3	48	4		New 4SCCBN 030 005 012	3 X R0.5	1.2	-	66	6	
4SCCBN 015 0005 040	1.5 X R0.05	0.8	4	48	4		4SCCBN 030 005 060	3 X R0.5	1.2	6	66	6	
New 4SCCBN 015 001 008	1.5 X R0.1	0.8	-	48	4		4SCCBN 030 005 100	3 X R0.5	1.2	10	66	6	
4SCCBN 015 001 030	1.5 X R0.1	0.8	3	48	4		4SCCBN 030 005 160	3 X R0.5	1.2	16	66	6	
4SCCBN 015 001 040	1.5 X R0.1	0.8	4	48	4		New 4SCCBN 030 010 012	3 X R1	1.2	-	66	6	
New 4SCCBN 015 002 008	1.5 X R0.2	0.8	-	48	4		4SCCBN 030 010 060	3 X R1	1.2	6	66	6	
4SCCBN 015 002 030	1.5 X R0.2	0.8	3	48	4		4SCCBN 030 010 100	3 X R1	1.2	10	66	6	
4SCCBN 015 002 040	1.5 X R0.2	0.8	4	48	4		4SCCBN 030 010 160	3 X R1	1.2	16	66	6	
New 4SCCBN 015 003 008	1.5 X R0.3	0.8	-	48	4		New 4SCCBN 040 001 015	4 X R0.1	1.5	-	66	6	
4SCCBN 015 003 030	1.5 X R0.3	0.8	3	48	4		4SCCBN 040 001 060	4 X R0.1	1.5	6	66	6	
4SCCBN 015 003 040	1.5 X R0.3	0.8	4	48	4		4SCCBN 040 001 100	4 X R0.1	1.5	10	66	6	
New 4SCCBN 020 0002 009	2 X R0.02	0.9	-	50	4		4SCCBN 040 001 160	4 X R0.1	1.5	16	66	6	
4SCCBN 020 0002 030	2 X R0.02	0.9	3	50	4		New 4SCCBN 040 002 015	4 X R0.2	1.5	-	66	6	
4SCCBN 020 0002 040	2 X R0.02	0.9	4	50	4		4SCCBN 040 002 060	4 X R0.2	1.5	6	66	6	
4SCCBN 020 0002 060	2 X R0.02	0.9	6	50	4		4SCCBN 040 002 100	4 X R0.2	1.5	10	66	6	
New 4SCCBN 020 0005 009	2 X R0.05	0.9	-	50	4		4SCCBN 040 002 160	4 X R0.2	1.5	16	66	6	
4SCCBN 020 0005 030	2 X R0.05	0.9	3	50	4		New 4SCCBN 040 003 015	4 X R0.3	1.5	-	66	6	
4SCCBN 020 0005 040	2 X R0.05	0.9	4	50	4		4SCCBN 040 003 060	4 X R0.3	1.5	6	66	6	
4SCCBN 020 0005 060	2 X R0.05	0.9	6	50	4		4SCCBN 040 003 100	4 X R0.3	1.5	10	66	6	
New 4SCCBN 020 001 009	2 X R0.1	0.9	-	50	4		4SCCBN 040 003 160	4 X R0.3	1.5	16	66	6	
4SCCBN 020 001 030	2 X R0.1	0.9	3	50	4		New 4SCCBN 040 005 015	4 X R0.5	1.5	-	66	6	
4SCCBN 020 001 040	2 X R0.1	0.9	4	50	4		4SCCBN 040 005 060	4 X R0.5	1.5	6	66	6	
4SCCBN 020 001 060	2 X R0.1	0.9	6	50	4		4SCCBN 040 005 100	4 X R0.5	1.5	10	66	6	
New 4SCCBN 020 002 009	2 X R0.2	0.9	-	50	4		4SCCBN 040 005 160	4 X R0.5	1.5	16	66	6	
4SCCBN 020 002 030	2 X R0.2	0.9	3	50	4		New 4SCCBN 040 010 015	4 X R1	1.5	-	66	6	
4SCCBN 020 002 040	2 X R0.2	0.9	4	50	4		4SCCBN 040 010 060	4 X R1	1.5	6	66	6	
4SCCBN 020 002 060	2 X R0.2	0.9	6	50	4		4SCCBN 040 010 100	4 X R1	1.5	10	66	6	



# 4SCCBN CBN, 4 Flutes High Speed Straight Rib Corner Radius End Mills

## 4날 CBN 고속가공용 직선날 리브 코너 레디우스 엔드밀

CBN series

단위 : mm

Order Number	날경 Diameter D	날장 Length of cut L1	유효장 Effective Length L2	전장 Overall Length L	셴크 Shank Dia d	비고	Order Number	날경 Diameter D	날장 Length of cut L1	유효장 Effective Length L2	전장 Overall Length L	셴크 Shank Dia d	비고
4SCCBN 040 010 160	4 X R1	1.5	16	66	6								
4SCCBN 060 003 030	6 X R0.3	3	-	83	6								
4SCCBN 060 003 150	6 X R0.3	3	15	83	6								
4SCCBN 060 005 030	6 X R0.5	3	-	83	6								
4SCCBN 060 005 150	6 X R0.5	3	15	83	6								
4SCCBN 060 010 030	6 X R1	3	-	83	6								
4SCCBN 060 010 150	6 X R1	3	15	83	6								



단위 : mm

Order Number	날경 Diameter R × D	날장 Length of cut L1	유효장 Effective Length L2	전장 Overall Length L	샙크 Shank Dia d	비고	Order Number	날경 Diameter R × D	날장 Length of cut L1	유효장 Effective Length L2	전장 Overall Length L	샙크 Shank Dia d	비고
2JJRB 010 030 S06	0.5R X 1	1	3	50	6		2JJRB 015 160 S04	0.75R X 1.5	1.5	16	50	4	
2JJRB 010 040 S04	0.5R X 1	1	4	45	4		2JJRB 015 160 S06	0.75R X 1.5	1.5	16	60	6	
2JJRB 010 040 S06	0.5R X 1	1	4	50	6		2JJRB 015 180 S04	0.75R X 1.5	1.5	18	50	4	
2JJRB 010 050 S04	0.5R X 1	1	5	45	4		2JJRB 015 200 S04	0.75R X 1.5	1.5	20	50	4	
2JJRB 010 050 S06	0.5R X 1	1	5	50	6		2JJRB 015 220 S04	0.75R X 1.5	1.5	22	60	4	
2JJRB 010 060 S04	0.5R X 1	1	6	45	4		2JJRB 015 250 S04	0.75R X 1.5	1.5	25	60	4	
2JJRB 010 060 S06	0.5R X 1	1	6	50	6		2JJRB 015 300 S04	0.75R X 1.5	1.5	30	70	4	
2JJRB 010 080 S04	0.5R X 1	1	8	45	4		2JJRB 016 060 S04	0.8R X 1.6	1.6	6	45	4	
2JJRB 010 080 S06	0.5R X 1	1	8	50	6		2JJRB 016 080 S04	0.8R X 1.6	1.6	8	45	4	
2JJRB 010 100 S04	0.5R X 1	1	10	50	4		2JJRB 016 120 S04	0.8R X 1.6	1.6	12	50	4	
2JJRB 010 100 S06	0.5R X 1	1	10	50	6		2JJRB 016 160 S04	0.8R X 1.6	1.6	16	50	4	
2JJRB 010 120 S04	0.5R X 1	1	12	50	4		2JJRB 016 200 S04	0.8R X 1.6	1.6	20	50	4	
2JJRB 010 120 S06	0.5R X 1	1	12	50	6		2JJRB 018 060 S04	0.9R X 1.8	1.8	6	45	4	
2JJRB 010 140 S04	0.5R X 1	1	14	50	4		2JJRB 018 080 S04	0.9R X 1.8	1.8	8	45	4	
2JJRB 010 160 S04	0.5R X 1	1	16	50	4		2JJRB 018 120 S04	0.9R X 1.8	1.8	12	50	4	
2JJRB 010 180 S04	0.5R X 1	1	18	50	4		2JJRB 018 160 S04	0.9R X 1.8	1.8	16	50	4	
2JJRB 010 200 S04	0.5R X 1	1	20	50	4		2JJRB 018 200 S04	0.9R X 1.8	1.8	20	50	4	
2JJRB 010 220 S04	0.5R X 1	1	22	60	4		2JJRB 020 040 S04	1R X 2	2	4	45	4	
2JJRB 010 250 S04	0.5R X 1	1	25	60	4		2JJRB 020 040 S06	1R X 2	2	4	50	6	
2JJRB 012 040 S04	0.6R X 1.2	1.2	4	45	4		2JJRB 020 060 S04	1R X 2	2	6	45	4	
2JJRB 012 040 S06	0.6R X 1.2	1.2	4	50	6		2JJRB 020 060 S06	1R X 2	2	6	50	6	
2JJRB 012 060 S04	0.6R X 1.2	1.2	6	45	4		2JJRB 020 080 S04	1R X 2	2	8	45	4	
2JJRB 012 060 S06	0.6R X 1.2	1.2	6	50	6		2JJRB 020 080 S06	1R X 2	2	8	50	6	
2JJRB 012 080 S04	0.6R X 1.2	1.2	8	45	4		2JJRB 020 100 S04	1R X 2	2	10	50	4	
2JJRB 012 080 S06	0.6R X 1.2	1.2	8	50	6		2JJRB 020 100 S06	1R X 2	2	10	50	6	
2JJRB 012 100 S04	0.6R X 1.2	1.2	10	50	4		2JJRB 020 120 S04	1R X 2	2	12	50	4	
2JJRB 012 100 S06	0.6R X 1.2	1.2	10	50	6		2JJRB 020 120 S06	1R X 2	2	12	50	6	
2JJRB 012 120 S04	0.6R X 1.2	1.2	12	50	4		2JJRB 020 140 S04	1R X 2	2	14	50	4	
2JJRB 012 120 S06	0.6R X 1.2	1.2	12	50	6		2JJRB 020 140 S06	1R X 2	2	14	50	6	
2JJRB 012 160 S04	0.6R X 1.2	1.2	16	50	4		2JJRB 020 160 S04	1R X 2	2	16	50	4	
2JJRB 012 200 S04	0.6R X 1.2	1.2	20	50	4		2JJRB 020 160 S06	1R X 2	2	16	60	6	
2JJRB 012 240 S04	0.6R X 1.2	1.2	24	60	4		2JJRB 020 180 S04	1R X 2	2	18	50	4	
2JJRB 014 060 S04	0.7R X 1.4	1.4	6	45	4		2JJRB 020 180 S06	1R X 2	2	18	60	6	
2JJRB 014 080 S04	0.7R X 1.4	1.4	8	45	4		2JJRB 020 200 S04	1R X 2	2	20	50	4	
2JJRB 014 120 S04	0.7R X 1.4	1.4	12	50	4		2JJRB 020 200 S06	1R X 2	2	20	60	6	
2JJRB 014 160 S04	0.7R X 1.4	1.4	16	50	4		2JJRB 020 220 S04	1R X 2	2	22	60	4	
2JJRB 015 030 S04	0.75R X 1.5	1.5	3	45	4		2JJRB 020 250 S04	1R X 2	2	25	60	4	
2JJRB 015 030 S06	0.75R X 1.5	1.5	3	50	6		2JJRB 020 300 S04	1R X 2	2	30	60	4	
2JJRB 015 040 S04	0.75R X 1.5	1.5	4	45	4		2JJRB 025 080 S04	1.25R X 2.5	2.5	8	45	4	
2JJRB 015 040 S06	0.75R X 1.5	1.5	4	50	6		2JJRB 025 080 S06	1.25R X 2.5	2.5	8	50	6	
2JJRB 015 060 S04	0.75R X 1.5	1.5	6	45	4		2JJRB 025 100 S04	1.25R X 2.5	2.5	10	50	4	
2JJRB 015 060 S06	0.75R X 1.5	1.5	6	50	6		2JJRB 025 100 S06	1.25R X 2.5	2.5	10	50	6	
2JJRB 015 080 S04	0.75R X 1.5	1.5	8	45	4		2JJRB 025 120 S04	1.25R X 2.5	2.5	12	50	4	
2JJRB 015 080 S06	0.75R X 1.5	1.5	8	50	6		2JJRB 025 120 S06	1.25R X 2.5	2.5	12	50	6	
2JJRB 015 100 S04	0.75R X 1.5	1.5	10	50	4		2JJRB 025 160 S04	1.25R X 2.5	2.5	16	50	4	
2JJRB 015 100 S06	0.75R X 1.5	1.5	10	50	6		2JJRB 025 160 S06	1.25R X 2.5	2.5	16	60	6	
2JJRB 015 120 S04	0.75R X 1.5	1.5	12	50	4		2JJRB 025 200 S04	1.25R X 2.5	2.5	20	60	4	
2JJRB 015 120 S06	0.75R X 1.5	1.5	12	50	6		2JJRB 025 200 S06	1.25R X 2.5	2.5	20	60	6	
2JJRB 015 140 S04	0.75R X 1.5	1.5	14	50	4		2JJRB 025 250 S04	1.25R X 2.5	2.5	25	60	4	
2JJRB 015 140 S06	0.75R X 1.5	1.5	14	50	6		2JJRB 025 300 S04	1.25R X 2.5	2.5	30	70	4	

단위 : mm

Order Number	날경 Diameter R × D	날장 Length of cut L1	유효장 Effective Length L2	전장 Overall Length L	샙크 Shank Dia d	비고	Order Number	날경 Diameter R × D	날장 Length of cut L1	유효장 Effective Length L2	전장 Overall Length L	샙크 Shank Dia d	비고
2JJRB 030 060 S06	1.5R X 3	3	6	50	6								
2JJRB 030 080 S06	1.5R X 3	3	8	50	6								
2JJRB 030 100 S06	1.5R X 3	3	10	50	6								
2JJRB 030 120 S06	1.5R X 3	3	12	50	6								
2JJRB 030 160 S06	1.5R X 3	3	16	60	6								
2JJRB 030 200 S06	1.5R X 3	3	20	60	6								
2JJRB 030 250 S06	1.5R X 3	3	25	65	6								
2JJRB 030 300 S06	1.5R X 3	3	30	70	6								
2JJRB 030 350 S06	1.5R X 3	3	35	75	6								
2JJRB 030 400 S06	1.5R X 3	3	40	80	6								
2JJRB 030 450 S06	1.5R X 3	3	45	90	6								
2JJRB 030 500 S06	1.5R X 3	3	50	100	6								
2JJRB 035 100 S06	1.75R X 3.5	3.5	10	50	6								
2JJRB 035 150 S06	1.75R X 3.5	3.5	15	60	6								
2JJRB 035 200 S06	1.75R X 3.5	3.5	20	60	6								
2JJRB 035 250 S06	1.75R X 3.5	3.5	25	65	6								
2JJRB 035 300 S06	1.75R X 3.5	3.5	30	70	6								
2JJRB 035 350 S06	1.75R X 3.5	3.5	35	75	6								
2JJRB 035 400 S06	1.75R X 3.5	3.5	40	80	6								
2JJRB 040 080 S06	2R X 4	4	8	50	6								
2JJRB 040 100 S06	2R X 4	4	10	50	6								
2JJRB 040 120 S06	2R X 4	4	12	50	6								
2JJRB 040 160 S06	2R X 4	4	16	60	6								
2JJRB 040 200 S06	2R X 4	4	20	60	6								
2JJRB 040 250 S06	2R X 4	4	25	65	6								
2JJRB 040 300 S06	2R X 4	4	30	70	6								
2JJRB 040 350 S06	2R X 4	4	35	75	6								
2JJRB 040 400 S06	2R X 4	4	40	80	6								
2JJRB 040 450 S06	2R X 4	4	45	90	6								
2JJRB 040 500 S06	2R X 4	4	50	100	6								
2JJRB 050 160 S06	2.5R X 5	6	16	60	6								
2JJRB 050 200 S06	2.5R X 5	6	20	60	6								
2JJRB 050 250 S06	2.5R X 5	6	25	70	6								
2JJRB 050 300 S06	2.5R X 5	6	30	75	6								
2JJRB 050 400 S06	2.5R X 5	6	40	80	6								
2JJRB 050 450 S06	2.5R X 5	6	45	90	6								
2JJRB 050 500 S06	2.5R X 5	6	50	100	6								
2JJRB 060 150 S06	3R X 6	10	15	55	6								
2JJRB 060 300 100	3R X 6	10	30	100	6								
2JJRB 060 500 120	3R X 6	10	50	120	6								
2JJRB 080 250 060	4R X 8	12	25	60	8								
2JJRB 080 300 100	4R X 8	12	30	100	8								
2JJRB 080 600 120	4R X 8	12	60	120	8								
2JJRB 100 300 070	5R X 10	16	30	70	10								
2JJRB 100 450 100	5R X 10	16	45	100	10								
2JJRB 100 600 130	5R X 10	16	60	130	10								
2JJRB 120 300 075	6R X 12	18	30	75	12								
2JJRB 120 500 110	6R X 12	18	50	110	12								
2JJRB 120 600 130	6R X 12	18	60	130	12								

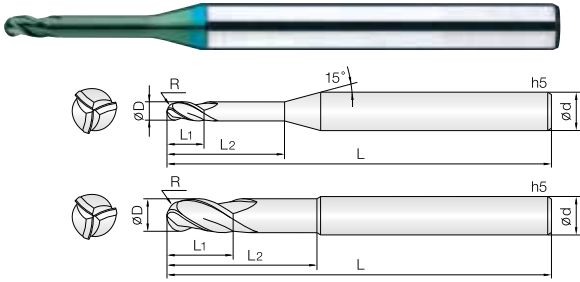

- 고정도강(HRc52~68), 프리하든강 계열의 고정밀 가공 엔드밀
- 고품량 실리콘계 코팅(Si) 처리하여 내마모성이 우수합니다.
- 고정밀 공차 적용으로 초정밀 가공에 적합합니다.
- 날부인선의 조도가 뛰어나 피삭재의 면조도가 우수합니다.
- 초미립자 초경합금(0.2 $\mu$ m)을 채택, 고속절삭시 뛰어난 성능을 발휘합니다.

#### • Endmills for pre-hardened and hardened steels(HRc52~68)

- Good wear resistance by high quality Si-based PVD coating.
- High precise edge tolerance.
- Excellent surface finish.
- Very nice work surface finish.
- Outstanding performance at high speed machining by ultra fine (0.2 $\mu$ m) WC grade.

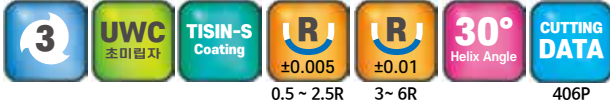

Condition	D Size	D Tolerance	Condition	D Size	D Tolerance
$\varnothing D \neq \varnothing d$	$\varnothing 1 \sim 12$	+0 ~ -0.01mm	$\varnothing D = \varnothing d$	$\varnothing 6 \sim 12$	-0.005 ~ -0.015mm

단위 : mm

Order Number	날경 Diameter R × D	날장 Length of cut L1	유효장 Effective Length L2	전장 Overall Length L	샙크 Shank Dia d	비고	Order Number	날경 Diameter R × D	날장 Length of cut L1	유효장 Effective Length L2	전장 Overall Length L	샙크 Shank Dia d	비고
3JJRB 010 040 S04	0.5R X 1	1.2	4	50	4								
3JJRB 010 060 S04	0.5R X 1	1.2	6	50	4								
3JJRB 010 080 S04	0.5R X 1	1.2	8	50	4								
3JJRB 010 100 S04	0.5R X 1	1.2	10	50	4								
3JJRB 010 120 S04	0.5R X 1	1.2	12	50	4								
3JJRB 010 160 S04	0.5R X 1	1.2	16	50	4								
3JJRB 015 060 S04	0.75R X 1.5	1.8	6	50	4								
3JJRB 015 080 S04	0.75R X 1.5	1.8	8	50	4								
3JJRB 015 100 S04	0.75R X 1.5	1.8	10	50	4								
3JJRB 015 120 S04	0.75R X 1.5	1.8	12	50	4								
3JJRB 015 160 S04	0.75R X 1.5	1.8	16	50	4								
3JJRB 015 200 S04	0.75R X 1.5	1.8	20	60	4								
3JJRB 020 080 S04	1R X 2	2.4	8	50	4								
3JJRB 020 100 S04	1R X 2	2.4	10	50	4								
3JJRB 020 120 S04	1R X 2	2.4	12	50	4								
3JJRB 020 160 S04	1R X 2	2.4	16	50	4								
3JJRB 020 200 S04	1R X 2	2.4	20	60	4								
3JJRB 020 250 S04	1R X 2	2.4	25	70	4								
3JJRB 025 080 S04	1.25R X 2.5	3	8	50	4								
3JJRB 025 100 S04	1.25R X 2.5	3	10	50	4								
3JJRB 025 120 S04	1.25R X 2.5	3	12	50	4								
3JJRB 025 160 S04	1.25R X 2.5	3	16	50	4								
3JJRB 025 200 S04	1.25R X 2.5	3	20	60	4								
3JJRB 025 250 S04	1.25R X 2.5	3	25	70	4								
3JJRB 030 120 S06	1.5R X 3	3.6	12	60	6								
3JJRB 030 160 S06	1.5R X 3	3.6	16	60	6								
3JJRB 030 200 S06	1.5R X 3	3.6	20	65	6								
3JJRB 030 250 S06	1.5R X 3	3.6	25	70	6								
3JJRB 030 300 S06	1.5R X 3	3.6	30	75	6								
3JJRB 030 400 S06	1.5R X 3	3.6	40	90	6								
3JJRB 030 500 S06	1.5R X 3	3.6	50	100	6								
3JJRB 040 160 S06	2R X 4	4.8	16	60	6								
3JJRB 040 200 S06	2R X 4	4.8	20	65	6								
3JJRB 040 250 S06	2R X 4	4.8	25	70	6								
3JJRB 040 300 S06	2R X 4	4.8	30	75	6								
3JJRB 040 400 S06	2R X 4	4.8	40	90	6								
3JJRB 040 500 S06	2R X 4	4.8	50	100	6								
3JJRB 040 600 S06	2R X 4	4.8	60	110	6								
3JJRB 050 300 S06	2.5R X 5	6	30	75	6								
3JJRB 050 400 S06	2.5R X 5	6	40	90	6								
3JJRB 050 500 S06	2.5R X 5	6	50	100	6								
3JJRB 050 600 S06	2.5R X 5	6	60	110	6								
3JJRB 060 200 060	3R X 6	9	20	60	6								
3JJRB 060 300 090	3R X 6	9	30	90	6								
3JJRB 080 250 060	4R X 8	12	25	60	8								
3JJRB 080 400 100	4R X 8	12	40	100	8								
3JJRB 100 300 070	5R X 10	15	30	70	10								
3JJRB 100 500 110	5R X 10	15	50	110	10								
3JJRB 120 350 075	6R X 12	18	35	75	12								
3JJRB 120 600 110	6R X 12	18	60	110	12								









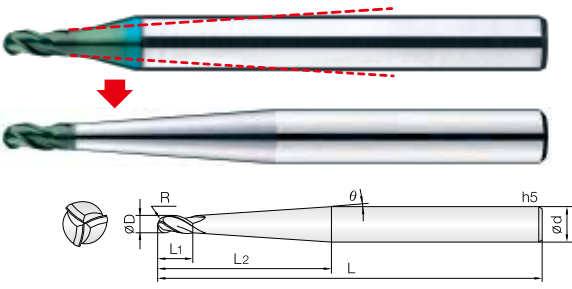

- 고정도강(HRC52~68), 프리하든강 계열의 고정밀 가공 엔드밀
- 깊은 홈 가공이 빈번해진 추세에 맞춰, 고객 요구에 빠르게 대응하는 맞춤형 제작 방식입니다. (최고 2일안에 납품가능)
- 고정밀 공차 적용으로 초정밀 가공에 적합합니다.
- 고객주문에 맞춰, 자사 재고품의 각도 및 유효길이를 재조정 가공합니다.
- 초미립자 초경합금(0.2μm)을 채택, 고속절삭시 뛰어난 성능을 발휘합니다.

- Endmills for pre-hardened and hardened steels(HRC52~68)
- Tailor-made special tools production for deep hole machining
- Suitable for ultra-precision machining by applying ultra-precision tolerances.
- With our STD stock the angle and effective length will be re-adjusted upon costumers' required order spec
- Adoped ultra-fine grain cemented carbide (0.2μm) and shows excellent performance during high-speed cutting.

3

UWC  
초미립자

TISIN-S  
Coating

R

R  
±0.005

R

R  
±0.01

30°

30°  
Helix Angle

CUTTING  
DATA

0.5 ~ 2.5R      3 ~ 6R      408P

Condition	D Size	D Tolerance
ØD ≠ Ød	Ø1 ~ 12	+0 ~ -0.01mm

단위 : mm

Order Number	날경 Diameter R × D	각도 Angle θ	날장 Length of cut L1	유효장 Effective Length L2	전장 Overall Length L	샤홅크 Shank Dia d	비고		
3JJTBS 010 060 S04	0.5R X 1	꺾어진 각도	1	꺾어진 유효장	60	4			
3JJTBS 010 080 S04	0.5R X 1		80		4				
3JJTBS 010 090 S06	0.5R X 1		90		6				
3JJTBS 015 060 S04	0.75R X 1.5	꺾어진 각도	1.5	꺾어진 유효장	60	4			
3JJTBS 015 080 S04	0.75R X 1.5		80		4				
3JJTBS 015 090 S06	0.75R X 1.5		90		6				
3JJTBS 020 070 S04	1R X 2	꺾어진 각도	2	꺾어진 유효장	70	4			
3JJTBS 020 090 S04	1R X 2		90		4				
3JJTBS 020 090 S06	1R X 2		90		6				
3JJTBS 030 080 S06	1.5R X 3	꺾어진 각도	3	꺾어진 유효장	80	6			
3JJTBS 030 100 S06	1.5R X 3		100		6				
3JJTBS 030 110 S08	1.5R X 3		110		8				
3JJTBS 040 080 S06	2R X 4	꺾어진 각도	5	꺾어진 유효장	80	6			
3JJTBS 040 110 S06	2R X 4		110		6				
3JJTBS 040 120 S08	2R X 4		120		8				
3JJTBS 050 090 S08	2.5R X 5	꺾어진 각도	7	꺾어진 유효장	90	8			
3JJTBS 050 120 S08	2.5R X 5		120		8				
3JJTBS 060 110 S08	3R X 6		110		8				
3JJTBS 060 150 S10	3R X 6	꺾어진 각도	9	꺾어진 유효장	150	10			
3JJTBS 080 120 S10	4R X 8		120		10				
3JJTBS 080 160 S12	4R X 8		160		12				
3JJTBS 100 120 S12	5R X 10	꺾어진 각도	15	꺾어진 유효장	120	12			
3JJTBS 100 160 S12	5R X 10		160		12				
3JJTBS 120 160 S16	6R X 12		160		16				
3JJTBS 120 200 S16	6R X 12	꺾어진 각도	18	꺾어진 유효장	200	16			
			꺾어진 각도			꺾어진 유효장			
					꺾어진 각도			꺾어진 유효장	
		꺾어진 각도					꺾어진 유효장		
			꺾어진 각도			꺾어진 유효장			
				꺾어진 각도				꺾어진 유효장	
		꺾어진 각도					꺾어진 유효장		
			꺾어진 각도			꺾어진 유효장			
				꺾어진 각도				꺾어진 유효장	
		꺾어진 각도					꺾어진 유효장		
			꺾어진 각도			꺾어진 유효장			
				꺾어진 각도				꺾어진 유효장	
		꺾어진 각도					꺾어진 유효장		
			꺾어진 각도			꺾어진 유효장			
				꺾어진 각도				꺾어진 유효장	
		꺾어진 각도					꺾어진 유효장		
			꺾어진 각도			꺾어진 유효장			
				꺾어진 각도				꺾어진 유효장	
		꺾어진 각도					꺾어진 유효장		
			꺾어진 각도			꺾어진 유효장			
				꺾어진 각도				꺾어진 유효장	
		꺾어진 각도					꺾어진 유효장		
			꺾어진 각도			꺾어진 유효장			
				꺾어진 각도				꺾어진 유효장	
		꺾어진 각도					꺾어진 유효장		
			꺾어진 각도			꺾어진 유효장			
				꺾어진 각도				꺾어진 유효장	

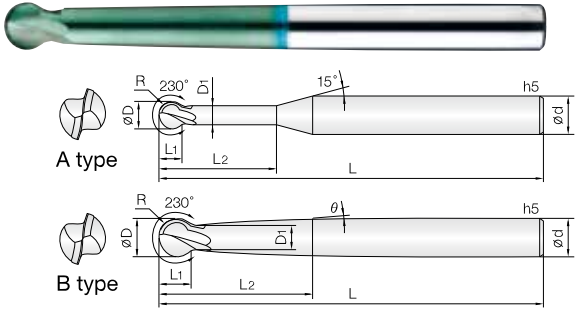

- 고경도강(HRc52~68), 프리하드강 계열의 고정밀 가공 엔드밀
  - 고품량 실리콘계 코팅(Si) 처리하여 내마모성이 우수합니다.
  - 230도 구형의 인선으로 광범위한 3D 가공이 가능합니다.
  - 유효장을 테이퍼 설계하여 깊은 홈 작업시 목부 파손 및 떨림을 최소화 하였습니다
  - 초미립자 초경합금(0.2µm)을 채택, 고속절삭시 뛰어난 성능을 발휘합니다.
- Endmills for pre-hardened and hardened steels(HRc52~68)
  - Good wear resistance by high quality Si-based PVD coating.
  - 230° degree ball shape for wide range 3D machining.
  - Minimize chattering and fracturing by taper designed flute.
  - Outstanding performance at high speed machining by ultra fine (0.2µm) WC grade.

2

UWC  
초미립자

TISIN-S  
Coating

R  
±0.005

R  
±0.01

15°  
Helix Angle

CUTTING  
DATA

0.25 ~ 2.5R    3 ~ 6R    410P

Condition	D Size	D Tolerance	Condition	D Size	D Tolerance
ØD ≠ Ød	Ø0.5 ~ 12	+0 ~ -0.01mm	ØD = Ød	Ø6 ~ 12	-0.005 ~ -0.015mm

단위 : mm

Order Number	날경 Diameter R × D	목경 Neck Diameter D1	날장 Length of cut L1	유효장 Effective Length L2	각도 Angle θ	전장 Overall Length L	타입 Type	샙크 Dia d	비고
New 2JJSP 005 010 S06	0.25R X 0.5	0.43	0.36	1	0°	55	A	6	
New 2JJSP 005 015 S06	0.25R X 0.5	0.43	0.36	1.5	0°	55	A	6	
New 2JJSP 005 020 S06	0.25R X 0.5	0.43	0.36	2	0°	55	A	6	
New 2JJSP 006 010 S06	0.3R X 0.6	0.52	0.43	1	0°	55	A	6	
New 2JJSP 006 020 S06	0.3R X 0.6	0.52	0.43	2	0°	55	A	6	
New 2JJSP 006 030 S06	0.3R X 0.6	0.52	0.43	3	0°	55	A	6	
New 2JJSP 008 020 S06	0.4R X 0.8	0.71	0.57	2	0°	55	A	6	
New 2JJSP 008 030 S06	0.4R X 0.8	0.71	0.57	3	0°	55	A	6	
New 2JJSP 008 040 S06	0.4R X 0.8	0.71	0.57	4	0°	55	A	6	
2JJSP 010 040 S06	0.5R X 1	0.91	0.7	4	0°	60	A	6	
2JJSP 010 060 S06	0.5R X 1	0.91	0.7	6	0°	60	A	6	
2JJSP 010 013 200	0.5R X 1	0.91	0.7	20	1°30'	80	B	6	
2JJSP 015 060 S06	0.75R X 1.5	1.36	1	6	0°	60	A	6	
2JJSP 015 080 S06	0.75R X 1.5	1.36	1	8	0°	60	A	6	
2JJSP 015 013 200	0.75R X 1.5	1.36	1	20	1°30'	80	B	6	
2JJSP 020 060 S06	1R X 2	1.8	1.4	6	0°	60	A	6	
2JJSP 020 100 S06	1R X 2	1.8	1.4	10	0°	60	A	6	
2JJSP 020 013 200	1R X 2	1.8	1.4	20	1°30'	80	B	6	
2JJSP 030 100 S06	1.5R X 3	2.7	2.1	10	0°	70	A	6	
2JJSP 030 150 S06	1.5R X 3	2.7	2.1	15	0°	70	A	6	
2JJSP 030 013 300	1.5R X 3	2.7	2.1	30	1°30'	80	B	6	
2JJSP 040 120 S06	2R X 4	3.6	2.8	12	0°	70	A	6	
2JJSP 040 200 S06	2R X 4	3.6	2.8	20	0°	70	A	6	
2JJSP 040 030 250	2R X 4	3.6	2.8	25	3°	80	B	6	
2JJSP 050 010 400	2.5R X 5	4.5	3.5	40	1°	90	B	6	
2JJSP 060 150 S06	3R X 6	5.4	4.2	15	0°	90	A	6	
2JJSP 060 300 S06	3R X 6	5.4	4.2	30	0°	90	A	6	
2JJSP 060 010 210	3R X 6	5.4	4.2	21	1°	100	B	6	
2JJSP 080 010 280	4R X 8	7.2	5.7	28	1°	100	B	8	
2JJSP 100 010 350	5R X 10	9	7.1	35	1°	110	B	10	
2JJSP 120 010 420	6R X 12	10.8	8.5	42	1°	120	B	12	

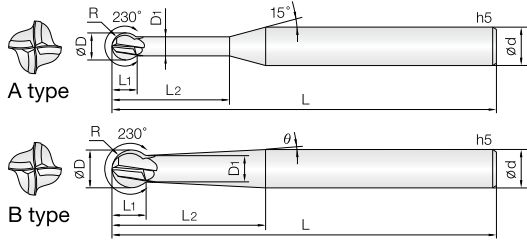

- 고경도강(HRC52~68), 프리하든강 계열의 고정밀 가공 엔드밀
- 고품량 실리콘계 코팅(Si) 처리하여 내마모성이 우수합니다.
- 230도 구형의 인선으로 광범위한 3D 가공이 가능합니다.
- 유효장을 테이퍼 설계하여 깊은 홈 작업시 목부 파손 및 떨림을 최소화 하였습니다
- 초미립자 초경합금(0.2 $\mu$ m)을 채택, 고속절삭시 뛰어난 성능을 발휘합니다.

#### • Endmills for pre-hardened and hardened steels(HRC52~68)

- Good wear resistance by high quality Si-based PVD coating.
- 230° degree ball shape for wide range 3D machining.
- Minimize chattering and fracturing by taper designed flute.
- Outstanding performance at high speed machining by ultra fine (0.2 $\mu$ m) WC grade.

4

UWC  
조미립자

TISIN-S  
Coating

R  
±0.005

R  
±0.01

15°  
Helix Angle

CUTTING  
DATA

0.5 ~ 2.5R    3 ~ 6R    411P

Condition	D Size	D Tolerance	Condition	D Size	D Tolerance
ØD ≠ Ød	Ø1 ~ 12	+0 ~ -0.01mm	ØD = Ød	Ø6 ~ 12	-0.005 ~ -0.015mm

단위 : mm

Order Number	날경 Diameter R × D	목경 Neck Diameter D1	날장 Length of cut L1	유효장 Effective Length L2	각도 Angle $\theta$	전장 Overall Length L	타입 Type	샹크 Shank Dia d	비고
4JJSP 010 040 S06	0.5R X 1	0.91	0.7	4	0°	60	A	6	
4JJSP 010 060 S06	0.5R X 1	0.91	0.7	6	0°	60	A	6	
4JJSP 010 013 200	0.5R X 1	0.91	0.7	20	1°30'	80	B	6	
4JJSP 015 060 S06	0.75R X 1.5	1.36	1	6	0°	60	A	6	
4JJSP 015 080 S06	0.75R X 1.5	1.36	1	8	0°	60	A	6	
4JJSP 015 013 200	0.75R X 1.5	1.36	1	20	1°30'	80	B	6	
4JJSP 020 060 S06	1R X 2	1.8	1.4	6	0°	60	A	6	
4JJSP 020 100 S06	1R X 2	1.8	1.4	10	0°	60	A	6	
4JJSP 020 013 200	1R X 2	1.8	1.4	20	1°30'	80	B	6	
4JJSP 030 100 S06	1.5R X 3	2.7	2.1	10	0°	70	A	6	
4JJSP 030 150 S06	1.5R X 3	2.7	2.1	15	0°	70	A	6	
4JJSP 030 013 300	1.5R X 3	2.7	2.1	30	1°30'	80	B	6	
4JJSP 040 120 S06	2R X 4	3.6	2.8	12	0°	70	A	6	
4JJSP 040 200 S06	2R X 4	3.6	2.8	20	0°	70	A	6	
4JJSP 040 030 250	2R X 4	3.6	2.8	25	3°	80	B	6	
4JJSP 050 010 400	2.5R X 5	4.5	3.5	40	1°	90	B	6	
4JJSP 060 150 S06	3R X 6	5.4	4.2	15	0°	90	A	6	
4JJSP 060 300 S06	3R X 6	5.4	4.2	30	0°	90	A	6	
4JJSP 060 010 210	3R X 6	5.4	4.2	21	1°	100	B	6	
4JJSP 080 010 280	4R X 8	7.2	5.7	28	1°	100	B	8	
4JJSP 100 010 350	5R X 10	9	7.1	35	1°	110	B	10	
4JJSP 120 010 420	6R X 12	10.8	8.5	42	1°	120	B	12	

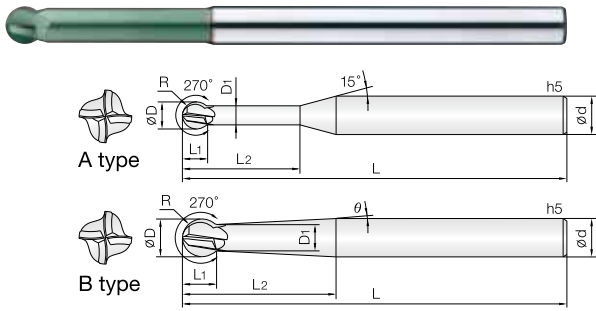

- 고경도강(HRc52~68), 프리하든강 계열의 고정밀 가공 엔드밀
- 고함량 실리콘계 코팅(Si) 처리하여 내마모성이 우수합니다.
- 270도 구형의 인선으로 광범위한 3D 가공이 가능합니다.
- 유효장을 테이퍼 설계하여 깊은 홈 작업시 목부 파손 및 떨림을 최소화 하였습니다.
- 초미립자 초경합금(0.2µm)을 채택, 고속절삭시 뛰어난 성능을 발휘합니다.

**Endmills for pre-hardened and hardened steels(HRc52~68)**

- Good wear resistance by high quality Si-based PVD coating.
- 270° degree ball shape for wide range 3D machining.
- Minimize chattering and fracturing by taper designed flute.
- Outstanding performance at high speed machining by ultra fine (0.2µm) WC grade.

4 UWC 초미립자 TISIN-S Coating R ±0.005 R ±0.01 15° Helix Angle CUTTING DATA 411P

Condition	D Size	D Tolerance	Condition	D Size	D Tolerance
ØD ≠ Ød	Ø1 ~ 12	+0 ~ -0.01mm	ØD = Ød	Ø6 ~ 12	-0.005 ~ -0.015mm

단위: mm

Order Number	날경 Diameter R × D	목경 Neck Diameter D1	날장 Length of cut L1	유효장 Effective Length L2	각도 Angle θ	전장 Overall Length L	타입 Type	샙크 Shank Dia d	비고
4JJSPPM 010 040 S06	0.5R X 1	0.7	0.8	4	0°	60	A	6	
4JJSPPM 010 060 S06	0.5R X 1	0.7	0.8	6	0°	60	A	6	
4JJSPPM 010 013 200	0.5R X 1	0.7	0.8	20	1°30'	80	B	6	
4JJSPPM 015 060 S06	0.75R X 1.5	1	1.2	6	0°	60	A	6	
4JJSPPM 015 080 S06	0.75R X 1.5	1	1.2	8	0°	60	A	6	
4JJSPPM 015 013 200	0.75R X 1.5	1	1.2	20	1°30'	80	B	6	
4JJSPPM 020 060 S06	1R X 2	1.4	1.7	6	0°	60	A	6	
4JJSPPM 020 100 S06	1R X 2	1.4	1.7	10	0°	60	A	6	
4JJSPPM 020 013 200	1R X 2	1.4	1.7	20	1°30'	80	B	6	
4JJSPPM 030 100 S06	1.5R X 3	2.1	2.5	10	0°	70	A	6	
4JJSPPM 030 150 S06	1.5R X 3	2.1	2.5	15	0°	70	A	6	
4JJSPPM 030 013 300	1.5R X 3	2.1	2.5	30	1°30'	80	B	6	
4JJSPPM 040120 S06	2R X 4	2.8	3.4	12	0°	70	A	6	
4JJSPPM 040 200 S06	2R X 4	2.8	3.4	20	0°	70	A	6	
4JJSPPM 040 030 250	2R X 4	2.8	3.4	25	3°	80	B	6	
4JJSPPM 050 010 400	2.5R X 5	3.5	4.2	40	1°	90	B	6	
4JJSPPM 060 150 S06	3R X 6	4.2	5.1	15	0°	90	A	6	
4JJSPPM 060 300 S06	3R X 6	4.2	5.1	30	0°	90	A	6	
4JJSPPM 060 010 210	3R X 6	4.2	5.1	21	1°	100	B	6	
4JJSPPM 080 010 280	4R X 8	5.6	6.8	28	1°	100	B	8	
4JJSPPM 100 010 350	5R X 10	7	8.5	35	1°	110	B	10	
4JJSPPM 120 010 420	6R X 12	8.5	10	42	1°	120	B	12	

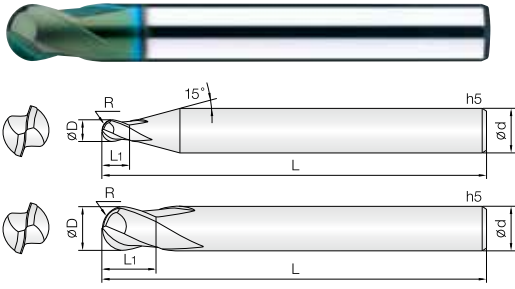

- 고경도강(HRc52~68), 프리하든강 계열의 고정밀 가공 엔드밀
- 고품량 실리콘계 코팅(Si) 처리하여 내마모성이 우수합니다.
- 고정밀 공차 적용으로 초정밀 가공에 적합합니다.
- 짧은 전장을 채택하여 열박음척 사용이 용이합니다.
- 날부인선의 조도가 뛰어나 피삭재의 면조도가 우수합니다.
- 초미립자 초경합금(0.2 $\mu$ m)을 채택, 고속절삭시 뛰어난 성능을 발휘합니다.

#### • Endmills for pre-hardened and hardened steels(HRc52~68)

- Good wear resistance by high quality Si-based PVD coating.
- High precise edge tolerance.
- Short overall length for easy use with shirinking chuck.
- Very nice work surface finish.
- Outstanding performance at high speed machining by ultra fine (0.2 $\mu$ m) WC grade.

2

UWC  
초미립자

TISIN-S  
Coating

R

R

30°  
Helix Angle

CUTTING  
DATA

0.05 ~ 2.5R    3 ~ 6R    411P

Condition	D Size	D Tolerance	Condition	D Size	D Tolerance
$\varnothing D \neq \varnothing d$	$\varnothing 0.1 \sim 0.15$	$+0 \sim -0.005\text{mm}$	$\varnothing D = \varnothing d$	$\varnothing 4 \sim 12$	$-0.005 \sim -0.015\text{mm}$
	$\varnothing 0.2 \sim 12$	$+0 \sim -0.01\text{mm}$			

단위 : mm

Order Number	날경 Diameter R × D	날장 Length of cut L1	전장 Overall Length L	생크 Shank Dia d	비고	Order Number	날경 Diameter R × D	날장 Length of cut L1	전장 Overall Length L	생크 Shank Dia d	비고
2JJSB 001 001 S04	0.05R X 0.1	0.1	40	4		2JJSB 120 120 060	6R X 12	12	60	12	
2JJSB 001 0015 S04	0.05R X 0.1	0.15	40	4		2JJSB 120 150 070	6R X 12	15	70	12	
2JJSB 0015 0015 S04	0.075R X 0.15	0.15	40	4							
2JJSB 0015 002 S04	0.075R X 0.15	0.2	40	4							
2JJSB 002 002 S04	0.1R X 0.2	0.2	40	4							
2JJSB 002 003 S04	0.1R X 0.2	0.3	40	4							
2JJSB 003 003 S04	0.15R X 0.3	0.3	40	4							
2JJSB 003 0045 S04	0.15R X 0.3	0.45	40	4							
2JJSB 004 004 S04	0.2R X 0.4	0.4	40	4							
2JJSB 004 006 S04	0.2R X 0.4	0.6	40	4							
2JJSB 005 005 S04	0.25R X 0.5	0.5	40	4							
2JJSB 005 0075 S04	0.25R X 0.5	0.75	40	4							
2JJSB 006 006 S04	0.3R X 0.6	0.6	40	4							
2JJSB 006 009 S04	0.3R X 0.6	0.9	40	4							
2JJSB 007 007 S04	0.35R X 0.7	0.7	40	4							
2JJSB 007 010 S04	0.35R X 0.7	1	40	4							
2JJSB 008 008 S04	0.4R X 0.8	0.8	40	4							
2JJSB 008 012 S04	0.4R X 0.8	1.2	40	4							
2JJSB 009 009 S04	0.45R X 0.9	0.9	40	4							
2JJSB 009 013 S04	0.45R X 0.9	1.3	40	4							
2JJSB 010 010 S04	0.5R X 1	1	40	4							
2JJSB 010 010 S06	0.5R X 1	1	40	6							
2JJSB 010 015 S04	0.5R X 1	1.5	40	4							
2JJSB 010 015 S06	0.5R X 1	1.5	40	6							
2JJSB 012 012 S04	0.6R X 1.2	1.2	40	4							
2JJSB 015 015 S04	0.75R X 1.5	1.5	40	4							
2JJSB 015 015 S06	0.75R X 1.5	1.5	40	6							
2JJSB 015 023 S04	0.75R X 1.5	2.3	40	4							
2JJSB 015 023 S06	0.75R X 1.5	2.3	40	6							
2JJSB 020 020 S04	1R X 2	2	45	4							
2JJSB 020 020 S06	1R X 2	2	45	6							
2JJSB 020 030 S04	1R X 2	3	45	4							
2JJSB 020 030 S06	1R X 2	3	45	6							
2JJSB 025 025 S06	1.25R X 2.5	2.5	45	6							
2JJSB 030 030 S04	1.5R X 3	3	45	4							
2JJSB 030 030 S06	1.5R X 3	3	45	6							
2JJSB 030 045 S04	1.5R X 3	4.5	45	4							
2JJSB 030 045 S06	1.5R X 3	4.5	45	6							
2JJSB 040 040 S04	2R X 4	4	45	4							
2JJSB 040 040 S06	2R X 4	4	45	6							
2JJSB 040 060 S04	2R X 4	6	45	4							
2JJSB 040 060 S06	2R X 4	6	45	6							
2JJSB 050 050 S06	2.5R X 5	5	50	6							
2JJSB 050 075 S06	2.5R X 5	7.5	50	6							
2JJSB 060 060 050	3R X 6	6	50	6							
2JJSB 060 080 055	3R X 6	8	55	6							
2JJSB 080 080 050	4R X 8	8	50	8							
2JJSB 080 110 060	4R X 8	11	60	8							
2JJSB 100 100 060	5R X 10	10	60	10							
2JJSB 100 130 070	5R X 10	13	70	10							

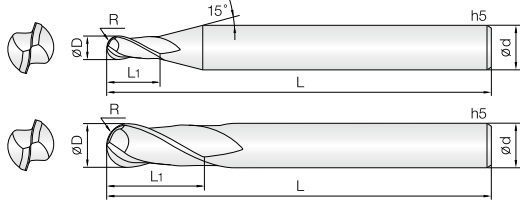

- 고경도강(HRc52~68), 프리하든강 계열의 고정밀 가공 엔드밀
- 고품량 실리콘계 코팅(Si) 처리하여 내마모성이 우수합니다.
- 고정밀 공차 적용으로 초정밀 가공에 적합합니다.
- 날부인선의 조도가 뛰어나 피삭재의 면조도가 우수합니다.
- 초미립자 초경합금(0.2µm)을 채택, 고속절삭시 뛰어난 성능을 발휘합니다.

#### Endmills for pre-hardened and hardened steels(HRc52~68)

- Good wear resistance by high quality Si-based PVD coating.
- High precise edge tolerance.
- Excellent surface finish.
- Very nice work surface finish.
- Outstanding performance at high speed machining by ultra fine (0.2µm) WC grade.

2

UWC  
초미립자

TISIN-S  
Coating

R  
±0.005

R  
±0.01

R  
±0.015

30°  
Helix Angle

CUTTING  
DATA

0.05 ~ 2.75R

3 ~ 6R

7R

411P

Condition	D Size		D Tolerance	
	ØD ≠ Ød	Ø0.1 ~ 0.15	+0 ~ -0.005mm	ØD = Ød
		Ø0.2 ~ 14	+0 ~ -0.01mm	
				Ø3 ~ 12
				Ø14
				-0.005 ~ -0.015mm
				-0.01 ~ -0.02mm

단위 : mm

Order Number	날경 Diameter R × D	날장 Length of cut L1	전장 Overall Length L	샙크 Shank Dia d	비고
2JJB 001 002 S04	0.05R X 0.1	0.2	40	4	
2JJB 0015 003 S04	0.075R X 0.15	0.3	40	4	
2JJB 002 004 S04	0.1R X 0.2	0.4	40	4	
2JJB 003 006 S04	0.15R X 0.3	0.6	40	4	
2JJB 004 008 S04	0.2R X 0.4	0.8	40	4	
2JJB 005 010 S04	0.25R X 0.5	1	45	4	
2JJB 006 012 S04	0.3R X 0.6	1.2	45	4	
2JJB 007 015 S04	0.35R X 0.7	1.5	45	4	
2JJB 008 020 S04	0.4R X 0.8	2	45	4	
2JJB 009 020 S04	0.45R X 0.9	2	45	4	
2JJB 010 025 S03	0.5R X 1	2.5	50	3	
2JJB 010 025 S04	0.5R X 1	2.5	50	4	
2JJB 010 025 S06	0.5R X 1	2.5	50	6	
2JJB 010 025 070	0.5R X 1	2.5	70	6	
2JJB 012 030 S03	0.6R X 1.2	3	50	3	
2JJB 012 030 S04	0.6R X 1.2	3	50	4	
2JJB 015 040 S03	0.75R X 1.5	4	50	3	
2JJB 015 040 S04	0.75R X 1.5	4	50	4	
2JJB 015 040 S06	0.75R X 1.5	4	50	6	
2JJB 015 040 070	0.75R X 1.5	4	70	6	
2JJB 020 050 S03	1R X 2	5	50	3	
2JJB 020 050 S04	1R X 2	5	50	4	
2JJB 020 050 S06	1R X 2	5	50	6	
2JJB 020 050 075	1R X 2	5	75	6	
2JJB 025 060 S03	1.25R X 2.5	6	50	3	
2JJB 025 060 S04	1.25R X 2.5	6	50	4	
2JJB 025 060 S06	1.25R X 2.5	6	75	6	
2JJB 030 080 S03	1.5R X 3	8	50	3	
2JJB 030 080 S04	1.5R X 3	8	50	4	
2JJB 030 080 S06	1.5R X 3	8	60	6	
2JJB 030 080 080	1.5R X 3	8	80	6	
2JJB 035 080 S06	1.75R X 3.5	8	60	6	
2JJB 040 080 S04	2R X 4	8	60	4	
2JJB 040 080 080	2R X 4	8	80	4	
2JJB 040 080 S06	2R X 4	8	70	6	
2JJB 040 080 090	2R X 4	8	90	6	
2JJB 045 080 S06	2.25R X 4.5	8	70	6	
2JJB 050 100 S06	2.5R X 5	10	75	6	
2JJB 055 100 S06	2.75R X 5.5	10	75	6	
2JJB 060 100 060	3R X 6	10	60	6	
2JJB 060 120 080	3R X 6	12	80	6	
2JJB 060 120 090	3R X 6	12	90	6	
2JJB 070 140 S08	3.5R X 7	14	80	8	
2JJB 080 120 060	4R X 8	12	60	8	
2JJB 080 140 090	4R X 8	14	90	8	
2JJB 080 140 100	4R X 8	14	100	8	
2JJB 100 150 070	5R X 10	15	70	10	
2JJB 100 180 100	5R X 10	18	100	10	
2JJB 120 180 075	6R X 12	18	75	12	
2JJB 120 220 110	6R X 12	22	110	12	



### 3 Flutes JJ Ball End Mills for Hardened Steels

## 3날 고정도재 가공용 제이제이 볼 엔드밀

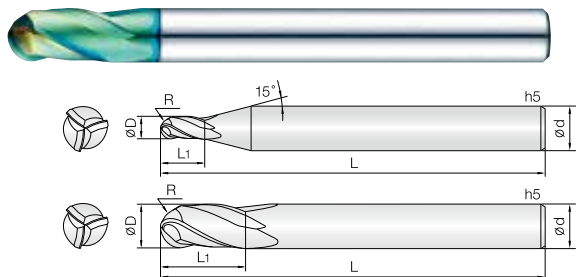

- 고정도강(HRC52~68), 프리하든강 계열의 고정밀 가공 엔드밀
- 고품량 실리콘계 코팅(Si) 처리하여 내마모성이 우수합니다.
- 고정밀 공차 적용으로 초정밀 가공에 적합합니다.
- 3날 볼타입 적용으로 고속, 고이송 작업이 가능합니다.
- 초미립자 초경합금(0.2 $\mu$ m)을 채택, 고속절삭시 뛰어난 성능을 발휘합니다.

### Endmills for pre-hardened and hardened steels(HRC52~68)

- Good wear resistance by high quality Si-based PVD coating.
- High precise edge tolerance.
- Three flutes ball edge design for high speed, feed condition.
- Outstanding performance at high speed machining by ultra fine (0.2 $\mu$ m) WC grade.

3 UWC 초미립자 TISIN-S Coating R ±0.005 R ±0.01 30° Helix Angle CUTTING DATA

0.5 ~ 2.5R 3 ~ 6R 411P

Condition	D Size	D Tolerance	Condition	D Size	D Tolerance
$\varnothing D \neq \varnothing d$	$\varnothing 1 \sim 12$	+0 ~ -0.01mm	$\varnothing D = \varnothing d$	$\varnothing 4 \sim 12$	-0.005 ~ -0.015mm

단위 : mm

Order Number	날경 Diameter R x D	날장 Length of cut L1	전장 Overall Length L	샤홅크 Shank Dia d	비고
3JJB 010 025 S04	0.5R X 1	2.5	50	4	
3JJB 012 030 S04	0.6R X 1.2	3	50	4	
3JJB 015 040 S04	0.75R X 1.5	4	50	4	
3JJB 020 050 S06	1R X 2	5	50	6	
3JJB 030 080 S06	1.5R X 3	8	65	6	
3JJB 040 080 S04	2R X 4	8	60	4	
3JJB 040 080 S06	2R X 4	8	70	6	
3JJB 050 100 S06	2.5R X 5	10	75	6	

Order Number	날경 Diameter R x D	날장 Length of cut L1	전장 Overall Length L	샤홅크 Shank Dia d	비고
3JJB 060 120 S06	3R X 6	12	80	6	
3JJB 060 120 120	3R X 6	12	120	6	
3JJB 080 140 S08	4R X 8	14	90	8	
3JJB 080 140 150	4R X 8	14	150	8	
3JJB 100 180 S10	5R X 10	18	100	10	
3JJB 100 180 150	5R X 10	18	150	10	
3JJB 120 220 S12	6R X 12	22	110	12	
3JJB 120 220 150	6R X 12	22	150	12	



### 4 Flutes JJ Short Length Ball End Mills for Hardened Steels

## 4날 고정도재 가공용 제이제이 짧은 길이 볼 엔드밀

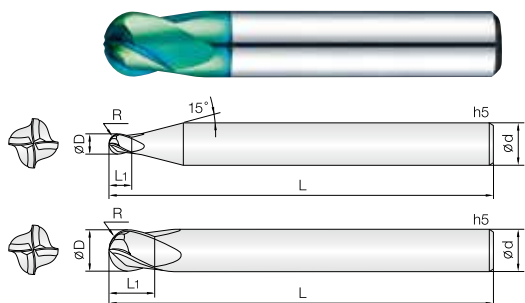

### 고정도강(HRC52~68), 프리하든강 계열의 고정밀 가공 엔드밀

- 고품량 실리콘계 코팅(Si) 처리하여 내마모성이 우수합니다.
- 고정밀 공차 적용으로 초정밀 가공에 적합합니다.
- 짧은 전장을 채택하여 열박음척 사용이 용이합니다.
- 4날 볼타입 적용으로 고속, 고이송 작업이 가능합니다.
- 초미립자 초경합금(0.2 $\mu$ m)을 채택, 고속절삭시 뛰어난 성능을 발휘합니다.

### Endmills for pre-hardened and hardened steels(HRC52~68)

- Good wear resistance by high quality Si-based PVD coating.
- High precise edge tolerance.
- Short overall length for easy use with shirking chuck.
- Four flutes ball edge design for high speed, feed condition.
- Outstanding performance at high speed machining by ultra fine (0.2 $\mu$ m) WC grade.

4 UWC 초미립자 TISIN-S Coating R ±0.005 R ±0.01 30° Helix Angle CUTTING DATA

0.5 ~ 2.5R 3 ~ 6R 411P

Condition	D Size	D Tolerance	Condition	D Size	D Tolerance
$\varnothing D \neq \varnothing d$	$\varnothing 1 \sim 12$	+0 ~ -0.01mm	$\varnothing D = \varnothing d$	$\varnothing 4 \sim 12$	-0.005 ~ -0.015mm

단위 : mm

Order Number	날경 Diameter R x D	날장 Length of cut L1	전장 Overall Length L	샤홅크 Shank Dia d	비고
4JJSB 010 012 S04	0.5R X 1	1.2	40	4	
4JJSB 012 015 S04	0.6R X 1.2	1.5	40	4	
4JJSB 015 018 S04	0.75R X 1.5	1.8	40	4	
4JJSB 020 024 S04	1R X 2	2.4	40	4	
4JJSB 025 030 S04	1.25R X 2.5	3	45	4	
4JJSB 030 036 S06	1.5R X 3	3.6	45	6	
4JJSB 040 050 S04	2R X 4	5	45	4	
4JJSB 040 050 S06	2R X 4	5	45	6	
4JJSB 050 060 S06	2.5R X 5	6	50	6	
4JJSB 060 070 S06	3R X 6	7	50	6	
4JJSB 060 070 060	3R X 6	7	60	6	
4JJSB 080 080 S08	4R X 8	8	60	8	
4JJSB 100 100 S10	5R X 10	10	60	10	
4JJSB 120 120 S12	6R X 12	12	75	12	

Order Number	날경 Diameter R x D	날장 Length of cut L1	전장 Overall Length L	샤홅크 Shank Dia d	비고





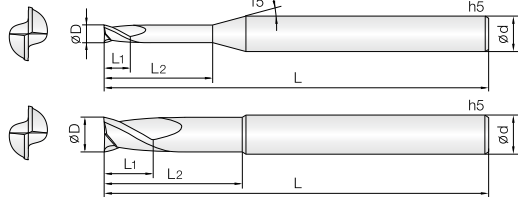
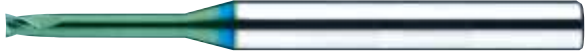

- 고경도강(HRc52~68), 프리하드강 계열의 고정밀 가공 엔드밀
- 고품량 실리콘계 코팅 (Si) 처리하여 내마모성이 우수합니다.
- 고정밀 공차 적용으로 초정밀 가공에 적합합니다.
- 인선부 강성을 보강하여 날부치핑을 최소화 하였습니다.
- 초미립자 초경합금 (0.2 $\mu$ m)을 채택, 고속절삭시 뛰어난 성능을 발휘합니다.

• Endmills for pre-hardened and hardened steels(HRc52~68)

- Good wear resistance by high quality Si-based PVD coating.
- High precise edge tolerance.
- Reinforced edge design for preventing edge chipping.
- Outstanding performance at high speed machining by ultra fine (0.2 $\mu$ m) WC grade.



Shield Edge 412P

Condition	D Size	D Tolerance	Condition	D Size	D Tolerance
ØD ≠ ød	Ø0.1 ~ 0.15	+0 ~ -0.005mm	ØD = ød	Ø6	-0.005 ~ -0.015mm
	Ø0.2 ~ 6	+0 ~ -0.01mm		Ø8 ~ 12	-0.01 ~ -0.025mm
	Ø8 ~ 12	+0 ~ -0.015mm			

단위 : mm

Order Number	날경 Diameter D	날장 Length of cut L1	유효장 Effective Length L2	전장 Overall Length L	생크 Shank Dia d	비고	Order Number	날경 Diameter D	날장 Length of cut L1	유효장 Effective Length L2	전장 Overall Length L	생크 Shank Dia d	비고
2JJRE 001 003 S04	0.1	0.15	0.3	40	4		2JJRE 005 140 S04	0.5	0.5	14	45	4	
2JJRE 001 005 S04	0.1	0.15	0.5	40	4		2JJRE 005 160 S04	0.5	0.5	16	45	4	
2JJRE 0015 003 S04	0.15	0.15	0.3	40	4		2JJRE 006 010 S04	0.6	0.6	1	40	4	
2JJRE 0015 005 S04	0.15	0.15	0.5	40	4		2JJRE 006 020 S04	0.6	0.6	2	40	4	
2JJRE 0015 0075 S04	0.15	0.15	0.75	40	4		2JJRE 006 030 S04	0.6	0.6	3	40	4	
2JJRE 0015 010 S04	0.15	0.15	1	40	4		2JJRE 006 040 S04	0.6	0.6	4	40	4	
2JJRE 002 005 S04	0.2	0.2	0.5	40	4		2JJRE 006 050 S04	0.6	0.6	5	40	4	
2JJRE 002 010 S04	0.2	0.2	1	40	4		2JJRE 006 060 S04	0.6	0.6	6	40	4	
2JJRE 002 015 S04	0.2	0.2	1.5	40	4		2JJRE 006 080 S04	0.6	0.6	8	45	4	
2JJRE 002 020 S04	0.2	0.2	2	40	4		2JJRE 006 100 S04	0.6	0.6	10	45	4	
2JJRE 002 025 S04	0.2	0.2	2.5	40	4		2JJRE 006 120 S04	0.6	0.6	12	45	4	
2JJRE 002 030 S04	0.2	0.2	3	40	4		2JJRE 006 140 S04	0.6	0.6	14	45	4	
2JJRE 0025 005 S04	0.25	0.25	0.5	40	4		2JJRE 006 160 S04	0.6	0.6	16	45	4	
2JJRE 0025 010 S04	0.25	0.25	1	40	4		2JJRE 006 180 S04	0.6	0.6	18	50	4	
2JJRE 0025 015 S04	0.25	0.25	1.5	40	4		2JJRE 007 020 S04	0.7	0.7	2	40	4	
2JJRE 0025 020 S04	0.25	0.25	2	40	4		2JJRE 007 040 S04	0.7	0.7	4	40	4	
2JJRE 0025 025 S04	0.25	0.25	2.5	40	4		2JJRE 007 060 S04	0.7	0.7	6	40	4	
2JJRE 0025 030 S04	0.25	0.25	3	40	4		2JJRE 007 080 S04	0.7	0.7	8	45	4	
2JJRE 003 010 S04	0.3	0.3	1	40	4		2JJRE 007 100 S04	0.7	0.7	10	45	4	
2JJRE 003 015 S04	0.3	0.3	1.5	40	4		2JJRE 007 120 S04	0.7	0.7	12	45	4	
2JJRE 003 020 S04	0.3	0.3	2	40	4		2JJRE 007 140 S04	0.7	0.7	14	45	4	
2JJRE 003 025 S04	0.3	0.3	2.5	40	4		2JJRE 007 160 S04	0.7	0.7	16	45	4	
2JJRE 003 030 S04	0.3	0.3	3	40	4		2JJRE 008 010 S04	0.8	0.8	1	40	4	
2JJRE 003 035 S04	0.3	0.3	3.5	40	4		2JJRE 008 020 S04	0.8	0.8	2	40	4	
2JJRE 003 040 S04	0.3	0.3	4	40	4		2JJRE 008 030 S04	0.8	0.8	3	40	4	
2JJRE 003 050 S04	0.3	0.3	5	40	4		2JJRE 008 040 S04	0.8	0.8	4	40	4	
2JJRE 003 060 S04	0.3	0.3	6	40	4		2JJRE 008 050 S04	0.8	0.8	5	40	4	
2JJRE 003 070 S04	0.3	0.3	7	40	4		2JJRE 008 060 S04	0.8	0.8	6	40	4	
2JJRE 003 080 S04	0.3	0.3	8	40	4		2JJRE 008 080 S04	0.8	0.8	8	45	4	
2JJRE 004 010 S04	0.4	0.4	1	40	4		2JJRE 008 100 S04	0.8	0.8	10	45	4	
2JJRE 004 015 S04	0.4	0.4	1.5	40	4		2JJRE 008 120 S04	0.8	0.8	12	45	4	
2JJRE 004 020 S04	0.4	0.4	2	40	4		2JJRE 008 140 S04	0.8	0.8	14	45	4	
2JJRE 004 025 S04	0.4	0.4	2.5	40	4		2JJRE 008 160 S04	0.8	0.8	16	45	4	
2JJRE 004 030 S04	0.4	0.4	3	40	4		2JJRE 008 180 S04	0.8	0.8	18	50	4	
2JJRE 004 035 S04	0.4	0.4	3.5	40	4		2JJRE 008 200 S04	0.8	0.8	20	50	4	
2JJRE 004 040 S04	0.4	0.4	4	40	4		2JJRE 009 040 S04	0.9	0.9	4	40	4	
2JJRE 004 050 S04	0.4	0.4	5	40	4		2JJRE 009 060 S04	0.9	0.9	6	40	4	
2JJRE 004 060 S04	0.4	0.4	6	40	4		2JJRE 009 080 S04	0.9	0.9	8	45	4	
2JJRE 004 080 S04	0.4	0.4	8	40	4		2JJRE 009 100 S04	0.9	0.9	10	45	4	
2JJRE 004 100 S04	0.4	0.4	10	45	4		2JJRE 010 020 S04	1	1	2	45	4	
2JJRE 004 120 S04	0.4	0.4	12	45	4		2JJRE 010 030 S04	1	1	3	45	4	
2JJRE 005 010 S04	0.5	0.5	1	40	4		2JJRE 010 040 S04	1	1	4	45	4	
2JJRE 005 020 S04	0.5	0.5	2	40	4		2JJRE 010 050 S04	1	1	5	45	4	
2JJRE 005 030 S04	0.5	0.5	3	40	4		2JJRE 010 060 S04	1	1	6	45	4	
2JJRE 005 040 S04	0.5	0.5	4	40	4		2JJRE 010 080 S04	1	1	8	45	4	
2JJRE 005 050 S04	0.5	0.5	5	40	4		2JJRE 010 100 S04	1	1	10	45	4	
2JJRE 005 060 S04	0.5	0.5	6	40	4		2JJRE 010 120 S04	1	1	12	50	4	
2JJRE 005 080 S04	0.5	0.5	8	45	4		2JJRE 010 140 S04	1	1	14	50	4	
2JJRE 005 100 S04	0.5	0.5	10	45	4		2JJRE 010 160 S04	1	1	16	50	4	
2JJRE 005 120 S04	0.5	0.5	12	45	4		2JJRE 010 180 S04	1	1	18	50	4	

단위 : mm

Order Number	날경 Diameter D	날장 Length of cut L1	유효장 Effective Length L2	전장 Overall Length L	샙크 Dia d	비고	Order Number	날경 Diameter D	날장 Length of cut L1	유효장 Effective Length L2	전장 Overall Length L	샙크 Dia d	비고
2JJRE 010 200 S04	1	1	20	50	4		2JJRE 025 350 S04	2.5	2.5	35	70	4	
2JJRE 010 220 S04	1	1	22	60	4		2JJRE 025 400 S04	2.5	2.5	40	80	4	
2JJRE 010 250 S04	1	1	25	60	4		2JJRE 025 450 S04	2.5	2.5	45	90	4	
2JJRE 010 300 S04	1	1	30	70	4		2JJRE 025 500 S04	2.5	2.5	50	90	4	
2JJRE 012 040 S04	1.2	1.2	4	45	4		2JJRE 030 060 S06	3	3	6	45	6	
2JJRE 012 060 S04	1.2	1.2	6	45	4		2JJRE 030 080 S06	3	3	8	45	6	
2JJRE 012 080 S04	1.2	1.2	8	45	4		2JJRE 030 100 S06	3	3	10	50	6	
2JJRE 012 100 S04	1.2	1.2	10	45	4		2JJRE 030 120 S06	3	3	12	50	6	
2JJRE 012 120 S04	1.2	1.2	12	50	4		2JJRE 030 160 S06	3	3	16	55	6	
2JJRE 012 160 S04	1.2	1.2	16	50	4		2JJRE 030 200 S06	3	3	20	60	6	
2JJRE 012 200 S04	1.2	1.2	20	50	4		2JJRE 030 250 S06	3	3	25	65	6	
2JJRE 012 250 S04	1.2	1.2	25	60	4		2JJRE 030 300 S06	3	3	30	70	6	
2JJRE 014 080 S04	1.4	1.4	8	45	4		2JJRE 030 350 S06	3	3	35	75	6	
2JJRE 014 100 S04	1.4	1.4	10	45	4		2JJRE 030 400 S06	3	3	40	80	6	
2JJRE 014 140 S04	1.4	1.4	14	50	4		2JJRE 030 450 S06	3	3	45	90	6	
2JJRE 014 160 S04	1.4	1.4	16	50	4		2JJRE 030 500 S06	3	3	50	100	6	
2JJRE 014 200 S04	1.4	1.4	20	50	4		2JJRE 030 600 S06	3	3	60	100	6	
2JJRE 014 220 S04	1.4	1.4	22	60	4		2JJRE 035 120 S06	3.5	3.5	12	50	6	
2JJRE 015 040 S04	1.5	1.5	4	45	4		2JJRE 035 160 S06	3.5	3.5	16	55	6	
2JJRE 015 060 S04	1.5	1.5	6	45	4		2JJRE 035 200 S06	3.5	3.5	20	60	6	
2JJRE 015 080 S04	1.5	1.5	8	45	4		2JJRE 035 250 S06	3.5	3.5	25	65	6	
2JJRE 015 100 S04	1.5	1.5	10	50	4		2JJRE 035 300 S06	3.5	3.5	30	70	6	
2JJRE 015 120 S04	1.5	1.5	12	50	4		2JJRE 035 350 S06	3.5	3.5	35	75	6	
2JJRE 015 140 S04	1.5	1.5	14	50	4		2JJRE 035 400 S06	3.5	3.5	40	80	6	
2JJRE 015 160 S04	1.5	1.5	16	50	4		2JJRE 040 080 S06	4	4	8	50	6	
2JJRE 015 180 S04	1.5	1.5	18	50	4		2JJRE 040 100 S06	4	4	10	50	6	
2JJRE 015 200 S04	1.5	1.5	20	50	4		2JJRE 040 120 S06	4	4	12	50	6	
2JJRE 015 220 S04	1.5	1.5	22	60	4		2JJRE 040 160 S06	4	4	16	55	6	
2JJRE 015 250 S04	1.5	1.5	25	60	4		2JJRE 040 200 S06	4	4	20	60	6	
2JJRE 015 350 S04	1.5	1.5	35	70	4		2JJRE 040 250 S06	4	4	25	65	6	
2JJRE 015 400 S04	1.5	1.5	40	80	4		2JJRE 040 300 S06	4	4	30	70	6	
2JJRE 016 060 S04	1.6	1.6	6	45	4		2JJRE 040 350 S06	4	4	35	75	6	
2JJRE 016 100 S04	1.6	1.6	10	50	4		2JJRE 040 400 S06	4	4	40	80	6	
2JJRE 016 140 S04	1.6	1.6	14	50	4		2JJRE 040 450 S06	4	4	45	90	6	
2JJRE 016 180 S04	1.6	1.6	18	50	4		2JJRE 040 500 S06	4	4	50	100	6	
2JJRE 016 200 S04	1.6	1.6	20	50	4		2JJRE 040 600 S06	4	4	60	100	6	
2JJRE 018 100 S04	1.8	1.8	10	50	4		2JJRE 045 120 S06	4.5	4.5	12	50	6	
2JJRE 018 120 S04	1.8	1.8	12	50	4		2JJRE 045 160 S06	4.5	4.5	16	55	6	
2JJRE 018 140 S04	1.8	1.8	14	50	4		2JJRE 045 200 S06	4.5	4.5	20	60	6	
2JJRE 018 160 S04	1.8	1.8	16	50	4		2JJRE 045 250 S06	4.5	4.5	25	65	6	
2JJRE 018 180 S04	1.8	1.8	18	50	4		2JJRE 045 300 S06	4.5	4.5	30	70	6	
2JJRE 018 200 S04	1.8	1.8	20	50	4		2JJRE 045 400 S06	4.5	4.5	40	80	6	
2JJRE 018 250 S04	1.8	1.8	25	60	4		2JJRE 050 160 S06	5	6	16	60	6	
2JJRE 020 060 S04	2	2	6	45	4		2JJRE 050 200 S06	5	6	20	60	6	
2JJRE 020 080 S04	2	2	8	45	4		2JJRE 050 250 S06	5	6	25	65	6	
2JJRE 020 100 S04	2	2	10	50	4		2JJRE 050 300 S06	5	6	30	70	6	
2JJRE 020 120 S04	2	2	12	50	4		2JJRE 050 350 S06	5	6	35	75	6	
2JJRE 020 140 S04	2	2	14	50	4		2JJRE 050 400 S06	5	6	40	80	6	
2JJRE 020 160 S04	2	2	16	50	4		2JJRE 050 500 S06	5	6	50	100	6	
2JJRE 020 180 S04	2	2	18	50	4		2JJRE 050 600 S06	5	6	60	100	6	
2JJRE 020 200 S04	2	2	20	50	4		2JJRE 060 200 S06	6	10	20	60	6	
2JJRE 020 220 S04	2	2	22	60	4		2JJRE 060 300 S06	6	10	30	75	6	
2JJRE 020 250 S04	2	2	25	60	4		2JJRE 060 400 S06	6	10	40	80	6	
2JJRE 020 300 S04	2	2	30	60	4		2JJRE 060 500 S06	6	10	50	90	6	
2JJRE 020 350 S04	2	2	35	70	4		2JJRE 060 600 S06	6	10	60	110	6	
2JJRE 020 400 S04	2	2	40	80	4		2JJRE 080 300 S08	8	12	30	80	8	
2JJRE 020 450 S04	2	2	45	90	4		2JJRE 080 500 S08	8	12	50	100	8	
2JJRE 020 500 S04	2	2	50	90	4		2JJRE 100 400 S10	10	15	40	90	10	
2JJRE 025 100 S04	2.5	2.5	10	50	4		2JJRE 100 600 S10	10	15	60	110	10	
2JJRE 025 120 S04	2.5	2.5	12	50	4		2JJRE 120 500 S12	12	18	50	100	12	
2JJRE 025 160 S04	2.5	2.5	16	50	4		2JJRE 120 700 S12	12	18	70	120	12	
2JJRE 025 200 S04	2.5	2.5	20	50	4								
2JJRE 025 250 S04	2.5	2.5	25	60	4								
2JJRE 025 300 S04	2.5	2.5	30	70	4								

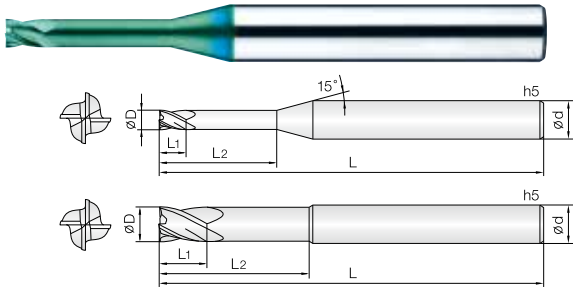

- 고정도강(HRc52~68), 프리하드강 계열의 고정밀 가공 엔드밀
- 고품량 실리콘계 코팅(Si) 처리하여 내마모성이 우수합니다.
- 고정밀 공차 적용으로 초정밀 가공에 적합합니다.
- 인선부 강성을 보강하여 날부치핑을 최소화 하였습니다.
- 초미립자 초경합금 (0.2 $\mu$ m)을 채택, 고속절삭시 뛰어난 성능을 발휘합니다.

#### • Endmills for pre-hardened and hardened steels(HRc52~68)

- Good wear resistance by high quality Si-based PVD coating.
- High precise edge tolerance.
- Reinforced edge design for preventing edge chipping.
- Outstanding performance at high speed machining by ultra fine (0.2 $\mu$ m) WC grade.



Shield Edge 412P

Condition	D Size	D Tolerance	Condition	D Size	D Tolerance
$\phi D \neq \phi d$	$\phi 0.5 \sim 6$	+0 ~ -0.01mm	$\phi D = \phi d$	$\phi 6$	-0.005 ~ -0.015mm
	$\phi 8 \sim 12$	+0 ~ -0.015mm		$\phi 8 \sim 12$	-0.01 ~ -0.025mm

단위 : mm

Order Number	날경 Diameter D	날장 Length of cut L1	유효장 Effective Length L2	전장 Overall Length L	생크 Shank Dia d	비고	Order Number	날경 Diameter D	날장 Length of cut L1	유효장 Effective Length L2	전장 Overall Length L	생크 Shank Dia d	비고
4JJRE 005 010 S04	0.5	0.5	1	40	4		4JJRE 012 200 S04	1.2	1.2	20	60	4	
4JJRE 005 020 S04	0.5	0.5	2	40	4		4JJRE 014 060 S04	1.4	1.4	6	45	4	
4JJRE 005 030 S04	0.5	0.5	3	45	4		4JJRE 014 080 S04	1.4	1.4	8	45	4	
4JJRE 005 040 S04	0.5	0.5	4	45	4		4JJRE 014 100 S04	1.4	1.4	10	50	4	
4JJRE 005 050 S04	0.5	0.5	5	45	4		4JJRE 014 120 S04	1.4	1.4	12	50	4	
4JJRE 005 060 S04	0.5	0.5	6	45	4		4JJRE 014 140 S04	1.4	1.4	14	50	4	
4JJRE 005 080 S04	0.5	0.5	8	45	4		4JJRE 014 160 S04	1.4	1.4	16	50	4	
4JJRE 005 100 S04	0.5	0.5	10	50	4		4JJRE 015 040 S04	1.5	1.5	4	45	4	
4JJRE 006 010 S04	0.6	0.6	1	45	4		4JJRE 015 060 S04	1.5	1.5	6	45	4	
4JJRE 006 020 S04	0.6	0.6	2	45	4		4JJRE 015 080 S04	1.5	1.5	8	45	4	
4JJRE 006 030 S04	0.6	0.6	3	45	4		4JJRE 015 100 S04	1.5	1.5	10	50	4	
4JJRE 006 040 S04	0.6	0.6	4	45	4		4JJRE 015 120 S04	1.5	1.5	12	50	4	
4JJRE 006 050 S04	0.6	0.6	5	45	4		4JJRE 015 160 S04	1.5	1.5	16	50	4	
4JJRE 006 060 S04	0.6	0.6	6	45	4		4JJRE 015 180 S04	1.5	1.5	18	60	4	
4JJRE 006 080 S04	0.6	0.6	8	45	4		4JJRE 015 200 S04	1.5	1.5	20	60	4	
4JJRE 006 100 S04	0.6	0.6	10	50	4		4JJRE 015 250 S04	1.5	1.5	25	60	4	
4JJRE 006 120 S04	0.6	0.6	12	50	4		4JJRE 015 300 S04	1.5	1.5	30	70	4	
4JJRE 007 020 S04	0.7	0.7	2	45	4		4JJRE 016 060 S04	1.6	1.6	6	45	4	
4JJRE 007 040 S04	0.7	0.7	4	45	4		4JJRE 016 080 S04	1.6	1.6	8	45	4	
4JJRE 007 060 S04	0.7	0.7	6	45	4		4JJRE 016 100 S04	1.6	1.6	10	50	4	
4JJRE 007 080 S04	0.7	0.7	8	45	4		4JJRE 016 120 S04	1.6	1.6	12	50	4	
4JJRE 007 100 S04	0.7	0.7	10	50	4		4JJRE 016 140 S04	1.6	1.6	14	50	4	
4JJRE 008 010 S04	0.8	0.8	1	40	4		4JJRE 016 160 S04	1.6	1.6	16	50	4	
4JJRE 008 020 S04	0.8	0.8	2	40	4		4JJRE 016 180 S04	1.6	1.6	18	60	4	
4JJRE 008 030 S04	0.8	0.8	3	40	4		4JJRE 016 200 S04	1.6	1.6	20	60	4	
4JJRE 008 040 S04	0.8	0.8	4	40	4		4JJRE 016 250 S04	1.6	1.6	25	70	4	
4JJRE 008 050 S04	0.8	0.8	5	40	4		4JJRE 018 060 S04	1.8	1.8	6	45	4	
4JJRE 008 060 S04	0.8	0.8	6	40	4		4JJRE 018 080 S04	1.8	1.8	8	45	4	
4JJRE 008 080 S04	0.8	0.8	8	40	4		4JJRE 018 100 S04	1.8	1.8	10	50	4	
4JJRE 008 100 S04	0.8	0.8	10	50	4		4JJRE 018 120 S04	1.8	1.8	12	50	4	
4JJRE 008 120 S04	0.8	0.8	12	50	4		4JJRE 018 160 S04	1.8	1.8	16	50	4	
4JJRE 008 160 S04	0.8	0.8	16	50	4		4JJRE 018 200 S04	1.8	1.8	20	60	4	
4JJRE 010 020 S04	1	1	2	45	4		4JJRE 018 250 S04	1.8	1.8	25	70	4	
4JJRE 010 030 S04	1	1	3	45	4		4JJRE 020 040 S04	2	2	4	45	4	
4JJRE 010 040 S04	1	1	4	45	4		4JJRE 020 060 S04	2	2	6	45	4	
4JJRE 010 060 S04	1	1	6	45	4		4JJRE 020 080 S04	2	2	8	45	4	
4JJRE 010 080 S04	1	1	8	45	4		4JJRE 020 100 S04	2	2	10	50	4	
4JJRE 010 100 S04	1	1	10	50	4		4JJRE 020 120 S04	2	2	12	50	4	
4JJRE 010 120 S04	1	1	12	50	4		4JJRE 020 140 S04	2	2	14	50	4	
4JJRE 010 140 S04	1	1	14	50	4		4JJRE 020 160 S04	2	2	16	50	4	
4JJRE 010 160 S04	1	1	16	50	4		4JJRE 020 180 S04	2	2	18	50	4	
4JJRE 010 180 S04	1	1	18	60	4		4JJRE 020 200 S04	2	2	20	50	4	
4JJRE 010 200 S04	1	1	20	60	4		4JJRE 020 220 S04	2	2	22	60	4	
4JJRE 012 040 S04	1.2	1.2	4	45	4		4JJRE 020 250 S04	2	2	25	60	4	
4JJRE 012 060 S04	1.2	1.2	6	45	4		4JJRE 020 300 S04	2	2	30	70	4	
4JJRE 012 080 S04	1.2	1.2	8	45	4		4JJRE 025 100 S04	2.5	2.5	10	50	4	
4JJRE 012 100 S04	1.2	1.2	10	50	4		4JJRE 025 120 S04	2.5	2.5	12	50	4	
4JJRE 012 120 S04	1.2	1.2	12	50	4		4JJRE 025 160 S04	2.5	2.5	16	50	4	
4JJRE 012 160 S04	1.2	1.2	16	50	4		4JJRE 025 200 S04	2.5	2.5	20	50	4	
4JJRE 012 180 S04	1.2	1.2	18	60	4		4JJRE 025 250 S04	2.5	2.5	25	60	4	

단위 : mm

Order Number	날경 Diameter D	날장 Length of cut L1	유효장 Effective Length L2	전장 Overall Length L	샙크 Shank Dia d	비고	Order Number	날경 Diameter D	날장 Length of cut L1	유효장 Effective Length L2	전장 Overall Length L	샙크 Shank Dia d	비고
4JJRE 025 300 S04	2.5	2.5	30	70	4								
4JJRE 030 060 S06	3	3	6	45	6								
4JJRE 030 080 S06	3	3	8	45	6								
4JJRE 030 100 S06	3	3	10	50	6								
4JJRE 030 120 S06	3	3	12	50	6								
4JJRE 030160 S06	3	3	16	55	6								
4JJRE 030 200 S06	3	3	20	60	6								
4JJRE 030 250 S06	3	3	25	65	6								
4JJRE 030 300 S06	3	3	30	70	6								
4JJRE 030 350 S06	3	3	35	75	6								
4JJRE 030 400 S06	3	3	40	80	6								
4JJRE 030 450 S06	3	3	45	90	6								
4JJRE 030 500 S06	3	3	50	100	6								
4JJRE 030 600 S06	3	3	60	110	6								
4JJRE 035 120 S06	3.5	3.5	12	50	6								
4JJRE 035 160 S06	3.5	3.5	16	55	6								
4JJRE 035 200 S06	3.5	3.5	20	60	6								
4JJRE 035 250 S06	3.5	3.5	25	65	6								
4JJRE 035 300 S06	3.5	3.5	30	70	6								
4JJRE 035 350 S06	3.5	3.5	35	75	6								
4JJRE 035 400 S06	3.5	3.5	40	80	6								
4JJRE 040 060 S06	4	4	6	50	6								
4JJRE 040 080 S06	4	4	8	50	6								
4JJRE 040 100 S06	4	4	10	50	6								
4JJRE 040 120 S06	4	4	12	50	6								
4JJRE 040 160 S06	4	4	16	55	6								
4JJRE 040 200 S06	4	4	20	60	6								
4JJRE 040 250 S06	4	4	25	65	6								
4JJRE 040 300 S06	4	4	30	70	6								
4JJRE 040 400 S06	4	4	40	80	6								
4JJRE 040 450 S06	4	4	45	90	6								
4JJRE 040 500 S06	4	4	50	100	6								
4JJRE 040 600 S06	4	4	60	110	6								
4JJRE 045 120 S06	4.5	4.5	12	50	6								
4JJRE 045 160 S06	4.5	4.5	16	55	6								
4JJRE 045 200 S06	4.5	4.5	20	60	6								
4JJRE 045 250 S06	4.5	4.5	25	65	6								
4JJRE 045 300 S06	4.5	4.5	30	70	6								
4JJRE 045 400 S06	4.5	4.5	40	80	6								
4JJRE 050 160 S06	5	5	16	60	6								
4JJRE 050 200 S06	5	5	20	60	6								
4JJRE 050 250 S06	5	5	25	65	6								
4JJRE 050 300 S06	5	5	30	70	6								
4JJRE 050 400 S06	5	5	40	80	6								
4JJRE 050 500 S06	5	5	50	100	6								
4JJRE 050 600 S06	5	5	60	110	6								
4JJRE 060 200 S06	6	6	20	60	6								
4JJRE 060 300 S06	6	6	30	75	6								
4JJRE 060 400 S06	6	6	40	80	6								
4JJRE 060 500 S06	6	6	50	90	6								
4JJRE 060 600 S06	6	6	60	100	6								
4JJRE 080 250 S08	8	12	25	65	8								
4JJRE 080 400 S08	8	12	40	100	8								
4JJRE 080 500 S08	8	12	50	110	8								
4JJRE 100 300 S10	10	15	30	70	10								
4JJRE 100 500 S10	10	15	50	100	10								
4JJRE 100 600 S10	10	15	60	120	10								
4JJRE 120 400 S12	12	18	40	80	12								
4JJRE 120 600 S12	12	18	60	110	12								
4JJRE 120 700 S12	12	18	70	130	12								

# 2JJE 2 Flutes JJ End Mills for Hardened Steels

## 2날 고정도재 가공용 제이제이 엔드밀

JJ series

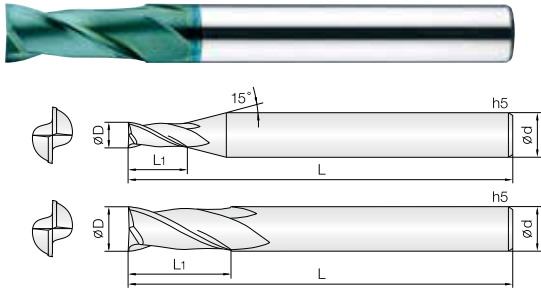

- 고정도강(HRc52~68), 프리하든강 계열의 고정밀 가공 엔드밀
- 고품량 실리콘계 코팅(Si) 처리하여 내마모성이 우수합니다.
- 고정밀 공차 적용으로 초정밀 가공에 적합합니다.
- 인선부 강성을 보강하여 날부치핑을 최소화 하였습니다.
- 국내최초 날경 0.03mm 제품부터 생산합니다.
- 초미립자 초경합금(0.2 $\mu$ m)을 채택, 고속절삭시 뛰어난 성능을 발휘합니다.

### • Endmills for pre-hardened and hardened steels(HRc52~68)

- Good wear resistance by high quality Si-based PVD coating.
- High precise edge tolerance.
- Reinforced edge design for preventing edge chipping.
- Produce down to 0.03mm in diameter endmills at the first time in Korea.
- Outstanding performance at high speed machining by ultra fine (0.2 $\mu$ m) WC grade.



Condition	D Size	D Tolerance	Condition	D Size	D Tolerance
ØD ≠ ød	Ø0.03 ~ 0.15	+0 ~ -0.005mm	ØD = ød	Ø3 ~ 6	-0.005 ~ -0.015mm
	Ø0.2 ~ 6	+0 ~ -0.01mm		Ø8 ~ 12	-0.01 ~ -0.025mm
	Ø6.5 ~ 20	+0 ~ -0.015mm		Ø14 ~ 20	-0.015 ~ -0.03mm

단위 : mm

Order Number	날경 Diameter D	날장 Length of cut L1	전장 Overall Length L	샙크 Shank Dia d	비고	Order Number	날경 Diameter D	날장 Length of cut L1	전장 Overall Length L	샙크 Shank Dia d	비고
2JJE 0003 00045 S04	0.03	0.045	40	4		2JJE 026 080 S04	2.6	8	45	4	
2JJE 0004 0006 S04	0.04	0.06	40	4		2JJE 027 080 S04	2.7	8	45	4	
2JJE 0005 0008 S04	0.05	0.08	40	4		2JJE 028 080 S04	2.8	8	45	4	
2JJE 0006 001 S04	0.06	0.1	40	4		2JJE 029 080 S04	2.9	8	45	4	
2JJE 0007 0012 S04	0.07	0.12	40	4		2JJE 030 080 S03	3	8	50	3	
2JJE 0008 0015 S04	0.08	0.15	40	4		2JJE 030 080 S04	3	8	45	4	
2JJE 0009 0017 S04	0.09	0.17	40	4		2JJE 030 080 S06	3	8	45	6	
2JJE 001 002 S04	0.1	0.2	40	4		2JJE 035 100 S06	3.5	10	45	6	
2JJE 0015 003 S04	0.15	0.3	40	4		2JJE 040 100 S04	4	10	45	4	
2JJE 002 004 S04	0.2	0.4	40	4		2JJE 040 110 S06	4	11	45	6	
2JJE 0025 005 S04	0.25	0.5	40	4		2JJE 045 110 S06	4.5	11	45	6	
2JJE 003 006 S04	0.3	0.6	40	4		2JJE 050 130 S06	5	13	50	6	
2JJE 0035 007 S04	0.35	0.7	40	4		2JJE 055 130 S06	5.5	13	50	6	
2JJE 004 008 S04	0.4	0.8	40	4		2JJE 060 130 S06	6	13	50	6	
2JJE 0045 009 S04	0.45	0.9	40	4		2JJE 065 160 S08	6.5	16	60	8	
2JJE 005 010 S04	0.5	1	40	4		2JJE 070 160 S08	7	16	60	8	
2JJE 0055 011 S04	0.55	1.1	40	4		2JJE 075 160 S08	7.5	16	60	8	
2JJE 006 012 S04	0.6	1.2	40	4		2JJE 080 190 S08	8	19	60	8	
2JJE 0065 013 S04	0.65	1.3	40	4		2JJE 085 190 S10	8.5	19	70	10	
2JJE 007 014 S04	0.7	1.4	40	4		2JJE 090 190 S10	9	19	70	10	
2JJE 0075 015 S04	0.75	1.5	40	4		2JJE 095 190 S10	9.5	19	70	10	
2JJE 008 016 S04	0.8	1.6	40	4		2JJE 100 220 S10	10	22	70	10	
2JJE 0085 017 S04	0.85	1.7	40	4		2JJE 105 220 S12	10.5	22	75	12	
2JJE 009 020 S04	0.9	2	40	4		2JJE 110 220 S12	11	22	75	12	
2JJE 0095 020 S04	0.95	2	40	4		2JJE 115 220 S12	11.5	22	75	12	
2JJE 010 025 S03	1	2.5	40	3		2JJE 120 260 S12	12	26	75	12	
2JJE 010 025 S04	1	2.5	40	4		2JJE 140 260 S14	14	26	80	14	
2JJE 010 025 S06	1	2.5	40	6		2JJE 140 260 S16	14	26	90	16	
2JJE 011 027 S04	1.1	2.7	40	4		2JJE 160 350 S16	16	35	100	16	
2JJE 012 030 S03	1.2	3	40	3		2JJE 180 350 S18	18	35	100	18	
2JJE 012 030 S04	1.2	3	40	4		2JJE 200 400 S20	20	40	100	20	
2JJE 013 032 S04	1.3	3.2	40	4							
2JJE 014 035 S04	1.4	3.5	40	4							
2JJE 015 040 S03	1.5	4	40	3							
2JJE 015 040 S04	1.5	4	40	4							
2JJE 015 040 S06	1.5	4	40	6							
2JJE 016 040 S04	1.6	4	40	4							
2JJE 017 042 S04	1.7	4.2	40	4							
2JJE 018 045 S04	1.8	4.5	40	4							
2JJE 019 050 S04	1.9	5	40	4							
2JJE 020 060 S03	2	6	40	3							
2JJE 020 060 S04	2	6	40	4							
2JJE 020 060 S06	2	6	40	6							
2JJE 021 060 S04	2.1	6	40	4							
2JJE 022 060 S04	2.2	6	40	4							
2JJE 023 060 S04	2.3	6	40	4							
2JJE 024 080 S04	2.4	8	45	4							
2JJE 025 080 S03	2.5	8	45	3							
2JJE 025 080 S04	2.5	8	45	4							
2JJE 025 080 S06	2.5	8	45	6							

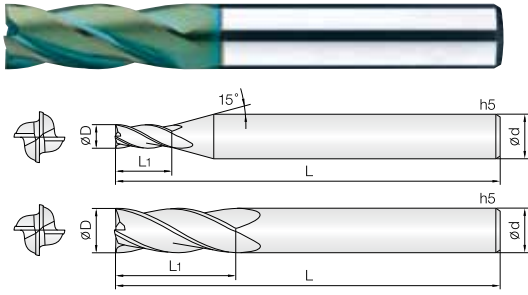

- 고정도강(HRc52~68), 프리하드강 계열의 고정밀 가공 엔드밀
- 고품량 실리콘계 코팅(Si) 처리하여 내마모성이 우수합니다.
- 고정밀 공차 적용으로 초정밀 가공에 적합합니다.
- 인선부 강성을 보강하여 날부치핑을 최소화 하였습니다.
- 초미립자 초경합금(0.2μm)을 채택, 고속절삭시 뛰어난 성능을 발휘합니다.

- Endmills for pre-hardened and hardened steels(HRc52~68)
- Good wear resistance by high quality Si-based PVD coating.
- High precise edge tolerance.
- Reinforced edge design for preventing edge chipping.
- Outstanding performance at high speed machining by ultra fine (0.2μm) WC grade.



Condition	D Size	D Tolerance	Condition	D Size	D Tolerance
øD ≠ ød	ø0.3 ~ 6	+0 ~ -0.01mm	øD = ød	ø3 ~ 6	-0.005 ~ -0.015mm
	ø8 ~ 20	+0 ~ -0.015mm		ø8 ~ 12	-0.01 ~ -0.025mm
		ø14 ~ 20		-0.015 ~ -0.03mm	

단위 : mm

Order Number	날경 Diameter D	날장 Length of cut L1	전장 Overall Length L	샙크 Shank Dia d	비고	Order Number	날경 Diameter D	날장 Length of cut L1	전장 Overall Length L	샙크 Shank Dia d	비고
4JJE 003 006 S04	0.3	0.6	40	4							
4JJE 004 008 S04	0.4	0.8	40	4							
4JJE 005 010 S04	0.5	1	40	4							
4JJE 006 012 S04	0.6	1.2	40	4							
4JJE 007 014 S04	0.7	1.4	40	4							
4JJE 008 016 S04	0.8	1.6	40	4							
4JJE 009 018 S04	0.9	1.8	40	4							
4JJE 010 025 S03	1	2.5	40	3							
4JJE 010 025 S04	1	2.5	40	4							
4JJE 010 025 S06	1	2.5	40	6							
4JJE 012 030 S03	1.2	3	40	3							
4JJE 012 030 S04	1.2	3	40	4							
4JJE 015 040 S03	1.5	4	40	3							
4JJE 015 040 S04	1.5	4	40	4							
4JJE 015 040 S06	1.5	4	40	6							
4JJE 020 060 S03	2	6	40	3							
4JJE 020 060 S04	2	6	40	4							
4JJE 020 060 S06	2	6	40	6							
4JJE 025 080 S03	2.5	8	45	3							
4JJE 025 080 S04	2.5	8	45	4							
4JJE 025 080 S06	2.5	8	45	6							
4JJE 030 080 S03	3	8	50	3							
4JJE 030 080 S04	3	8	45	4							
4JJE 030 080 S06	3	8	45	6							
4JJE 035 100 S06	3.5	10	45	6							
4JJE 040 110 S04	4	11	45	4							
4JJE 040 110 S06	4	11	45	6							
4JJE 045 110 S06	4.5	11	45	6							
4JJE 050 130 S06	5	13	50	6							
4JJE 055 130 S06	5.5	13	50	6							
4JJE 060 130 S06	6	13	50	6							
4JJE 080 190 S08	8	19	60	8							
4JJE 100 220 S10	10	22	70	10							
4JJE 120 260 S12	12	26	75	12							
4JJE 140 300 S14	14	30	90	14							
4JJE 160 350 S16	16	35	100	16							
4JJE 200 400 S20	20	40	100	20							

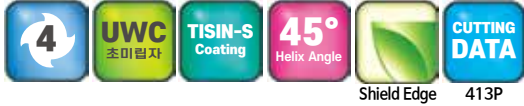
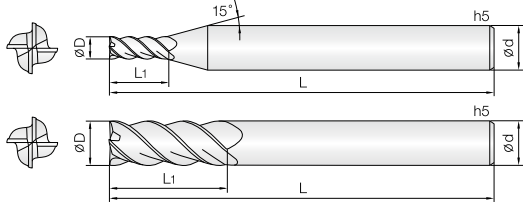

Shield Edge 413P

- 고정도강(HRc52~68), 프리하든강 계열의 고정밀 가공 엔드밀
- 고품량 실리콘계 코팅(Si) 처리하여 내마모성이 우수합니다.
- 고정밀 공차 적용으로 초정밀 가공에 적합합니다.
- 인선부 강성을 보강하여 날부치핑을 최소화 하였습니다.
- 국내최초 날경 0.03mm 제품부터 생산합니다.
- 초미립자 초경합금(0.2 $\mu$ m)을 채택, 고속절삭시 뛰어난 성능을 발휘합니다.

#### • Endmills for pre-hardened and hardened steels(HRc52~68)

- Good wear resistance by high quality Si-based PVD coating.
- High precise edge tolerance.
- Reinforced edge design for preventing edge chipping.
- Produce down to 0.03mm in diameter endmills at the first time in Korea.
- Outstanding performance at high speed machining by ultra fine (0.2 $\mu$ m) WC grade.

Condition	D Size	D Tolerance	Condition	D Size	D Tolerance
$\varnothing D \neq \varnothing d$	$\varnothing 0.3 \sim 6$	+0 ~ -0.01mm	$\varnothing D = \varnothing d$	$\varnothing 6$	-0.005 ~ -0.015mm
	$\varnothing 7 \sim 20$	+0 ~ -0.015mm		$\varnothing 8 \sim 12$	-0.01 ~ -0.025mm
		$\varnothing 14 \sim 20$		-0.015 ~ -0.03mm	

단위 : mm

Order Number	날경 Diameter D	날장 Length of cut L1	전장 Overall Length L	샙크 Shank Dia d	비고	Order Number	날경 Diameter D	날장 Length of cut L1	전장 Overall Length L	샙크 Shank Dia d	비고
New 4JJHE 003 006 S04	0.3	0.6	40	4		4JJHE 060 200 S06	6	20	60	6	
New 4JJHE 004 008 S04	0.4	0.8	40	4		4JJHE 060 250 S06	6	25	70	6	
New 4JJHE 005 008 S04	0.5	0.8	40	4		4JJHE 060 300 S06	6	30	75	6	
New 4JJHE 005 010 S04	0.5	1	40	4		4JJHE 070 160 S08	7	16	60	8	
New 4JJHE 006 009 S04	0.6	0.9	40	4		4JJHE 080 200 S08	8	20	60	8	
New 4JJHE 006 012 S04	0.6	1.2	40	4		4JJHE 080 250 S08	8	25	70	8	
New 4JJHE 008 012 S04	0.8	1.2	40	4		4JJHE 080 300 S08	8	30	80	8	
New 4JJHE 008 020 S04	0.8	2	40	4		4JJHE 080 400 S08	8	40	90	8	
New 4JJHE 010 015 S04	1	1.5	40	4		4JJHE 090 220 S10	9	22	70	10	
4JJHE 010 015 S06	1	1.5	40	6		4JJHE 100 220 S10	10	22	70	10	
New 4JJHE 010 025 S04	1	2.5	40	4		4JJHE 100 300 S10	10	30	80	10	
4JJHE 010 025 S06	1	2.5	40	6		4JJHE 100 400 S10	10	40	90	10	
New 4JJHE 010 035 S04	1	3.5	40	4		4JJHE 100 500 S10	10	50	100	10	
4JJHE 010 035 S06	1	3.5	40	6		4JJHE 120 260 S12	12	26	75	12	
4JJHE 010 050 S06	1	5	45	6		4JJHE 120 350 S12	12	35	90	12	
New 4JJHE 015 040 S04	1.5	4	40	4		4JJHE 120 500 S12	12	50	100	12	
4JJHE 015 040 S06	1.5	4	40	6		4JJHE 120 600 S12	12	60	110	12	
New 4JJHE 015 060 S04	1.5	6	40	4		4JJHE 140 350 S14	14	35	90	14	
4JJHE 015 060 S06	1.5	6	40	6		4JJHE 140 550 S14	14	55	110	14	
4JJHE 015 080 S06	1.5	8	40	6		4JJHE 160 350 S16	16	35	90	16	
New 4JJHE 020 030 S04	2	3	40	4		4JJHE 160 500 S16	16	50	110	16	
4JJHE 020 030 S06	2	3	40	6		4JJHE 160 700 S16	16	70	130	16	
New 4JJHE 020 050 S04	2	5	40	4		4JJHE 180 380 S18	18	38	100	18	
4JJHE 020 050 S06	2	5	40	6		4JJHE 200 400 S20	20	40	100	20	
4JJHE 020 080 S06	2	8	40	6		4JJHE 200 550 S20	20	55	120	20	
4JJHE 020 100 S06	2	10	45	6		4JJHE 200 750 S20	20	75	150	20	
New 4JJHE 025 060 S04	2.5	6	45	4							
4JJHE 025 060 S06	2.5	6	45	6							
New 4JJHE 025 080 S04	2.5	8	45	4							
4JJHE 025 080 S06	2.5	8	45	6							
4JJHE 025 100 S06	2.5	10	50	6							
New 4JJHE 030 060 S04	3	6	45	4							
4JJHE 030 060 S06	3	6	45	6							
New 4JJHE 030 080 S04	3	8	45	4							
4JJHE 030 080 S06	3	8	45	6							
4JJHE 030 120 S06	3	12	50	6							
4JJHE 030 150 S06	3	15	50	6							
4JJHE 035 080 S06	3.5	8	45	6							
4JJHE 040 080 S06	4	8	45	6							
4JJHE 040 110 S06	4	11	45	6							
4JJHE 040 150 S06	4	15	55	6							
4JJHE 040 200 S06	4	20	60	6							
4JJHE 045 110 S06	4.5	11	50	6							
4JJHE 050 100 S06	5	10	50	6							
4JJHE 050 130 S06	5	13	50	6							
4JJHE 050 200 S06	5	20	60	6							
4JJHE 050 250 S06	5	25	70	6							
4JJHE 050 300 S06	5	30	75	6							
4JJHE 060 130 S06	6	13	50	6							
4JJHE 060 150 S06	6	15	55	6							

### 6&8날 고경도재 가공용 제이제이 45° 헬릭스 엔드밀

JJ series

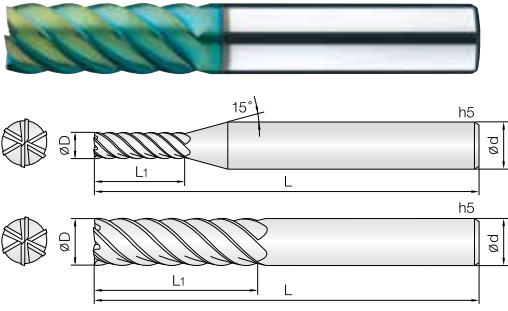

- 고경도강(HRc52~68), 프리하든강 계열의 고정밀 가공 엔드밀
- 고함량 실리콘계 코팅(Si) 처리하여 내마모성이 우수합니다.
- 고정밀 공차 적용으로 초정밀 가공에 적합합니다.
- 인선부 강성을 보강하여 날부치핑을 최소화 하였습니다.
- 국내최초 날경 0.03mm 제품부터 생산합니다.
- 초미립자 초경합금(0.2μm)을 채택, 고속절삭시 뛰어난 성능을 발휘합니다.

#### • Endmills for pre-hardened and hardened steels(HRc52~68)

- Good wear resistance by high quality Si-based PVD coating.
- High precise edge tolerance.
- Reinforced edge design for preventing edge chipping.
- Produce down to 0.03mm in diameter endmills at the first time in Korea.
- Outstanding performance at high speed machining by ultra fine (0.2μm) WC grade.



Shield Edge 413P

Condition	D Size	D Tolerance	Condition	D Size	D Tolerance
ØD ≠ Ød	Ø3 ~ 6	+0 ~ -0.01mm	ØD = Ød	Ø6	-0.005 ~ -0.015mm
	Ø8 ~ 25	+0 ~ -0.015mm		Ø8 ~ 12	-0.01 ~ -0.025mm
				Ø14 ~ 25	-0.015 ~ -0.03mm

단위 : mm

Order Number	날경 Diameter D	날장 Length of cut L1	전장 Overall Length L	생크 Shank Dia d	비고	Order Number	날경 Diameter D	날장 Length of cut L1	전장 Overall Length L	생크 Shank Dia d	비고
6JJHE 030 100 S06	3	10	50	6		8JJHE 250 1000 S25	25	100	160	25	
6JJHE 030 150 S06	3	15	50	6		8JJHE 250 1300 S25	25	130	200	25	
6JJHE 030 200 S06	3	20	60	6							
6JJHE 040 120 S06	4	12	50	6							
6JJHE 040 160 S06	4	16	50	6							
6JJHE 040 200 S06	4	20	60	6							
6JJHE 050 150 S06	5	15	50	6							
6JJHE 050 200 S06	5	20	60	6							
6JJHE 050 250 S06	5	25	60	6							
6JJHE 060 150 S06	6	15	50	6							
6JJHE 060 200 S06	6	20	60	6							
6JJHE 060 250 S06	6	25	65	6							
6JJHE 060 300 S06	6	30	70	6							
6JJHE 060 350 S06	6	35	75	6							
6JJHE 060 400 S06	6	40	80	6							
6JJHE 080 200 S08	8	20	60	8							
6JJHE 080 250 S08	8	25	65	8							
6JJHE 080 300 S08	8	30	75	8							
6JJHE 080 350 S08	8	35	80	8							
6JJHE 080 400 S08	8	40	90	8							
6JJHE 080 450 S08	8	45	100	8							
6JJHE 080 500 S08	8	50	100	8							
6JJHE 100 250 S10	10	25	70	10							
6JJHE 100 350 S10	10	35	90	10							
6JJHE 100 450 S10	10	45	100	10							
6JJHE 100 500 S10	10	50	100	10							
6JJHE 100 600 S10	10	60	110	10							
6JJHE 120 300 S12	12	30	80	12							
6JJHE 120 400 S12	12	40	90	12							
6JJHE 120 500 S12	12	50	100	12							
6JJHE 120 600 S12	12	60	110	12							
6JJHE 120 700 S12	12	70	120	12							
6JJHE 140 350 S14	14	35	90	14							
6JJHE 140 550 S14	14	55	110	14							
6JJHE 140 750 S14	14	75	150	14							
6JJHE 160 350 S16	16	35	90	16							
6JJHE 160 500 S16	16	50	110	16							
6JJHE 160 650 S16	16	65	120	16							
6JJHE 160 800 S16	16	80	150	16							
6JJHE 160 900 S16	16	90	160	16							
6JJHE 160 1000 S16	16	100	160	16							
6JJHE 180 400 S18	18	40	100	18							
6JJHE 180 650 S18	18	65	120	18							
6JJHE 200 450 S20	20	45	100	20							
6JJHE 200 600 S20	20	60	120	20							
6JJHE 200 800 S20	20	80	150	20							
6JJHE 200 900 S20	20	90	160	20							
6JJHE 200 1000 S20	20	100	160	20							
6JJHE 200 1100 S20	20	110	170	20							
6JJHE 200 1200 S20	20	120	180	20							







단위 : mm

Order Number	날경 D×R	날장 Length of cut L1	유효장 Effective Length L2	전장 Overall Length L	생크 Shank Dia d	비고	Order Number	날경 D×R	날장 Length of cut L1	유효장 Effective Length L2	전장 Overall Length L	생크 Shank Dia d	비고
2JJCR 015 005 100	1.5 X R0.5	1.5	10	50	4		2JJCR 025 002 200	2.5 X R0.2	2.5	10	50	4	
2JJCR 015 005 120	1.5 X R0.5	1.5	12	50	4		2JJCR 025 003 100	2.5 X R0.3	2.5	10	50	4	
2JJCR 015 005 140	1.5 X R0.5	1.5	14	50	4		2JJCR 025 003 160	2.5 X R0.3	2.5	16	50	4	
2JJCR 015 005 160	1.5 X R0.5	1.5	16	50	4		2JJCR 025 003 200	2.5 X R0.3	2.5	20	50	4	
2JJCR 015 005 200	1.5 X R0.5	1.5	20	50	4		2JJCR 025 005 100	2.5 X R0.5	2.5	10	50	4	
2JJCR 020 0002 060	2 X R0.02	2	6	45	4		2JJCR 025 005 160	2.5 X R0.5	2.5	16	50	4	
2JJCR 020 0002 080	2 X R0.02	2	8	45	4		2JJCR 025 005 200	2.5 X R0.5	2.5	20	50	4	
2JJCR 020 0002 100	2 X R0.02	2	10	50	4		2JJCR 030 001 100	3 X R0.1	3	10	50	6	
2JJCR 020 0002 120	2 X R0.02	2	12	50	4		2JJCR 030 001 120	3 X R0.1	3	12	50	6	
2JJCR 020 0002 140	2 X R0.02	2	14	50	4		2JJCR 030 001 160	3 X R0.1	3	16	55	6	
2JJCR 020 0002 160	2 X R0.02	2	16	50	4		2JJCR 030 001 200	3 X R0.1	3	20	60	6	
2JJCR 020 0002 200	2 X R0.02	2	20	50	4		2JJCR 030 001 250	3 X R0.1	3	25	65	6	
2JJCR 020 0002 250	2 X R0.02	2	25	60	4		2JJCR 030 001 300	3 X R0.1	3	30	70	6	
2JJCR 020 0005 060	2 X R0.05	2	6	45	4		2JJCR 030 001 350	3 X R0.1	3	35	75	6	
2JJCR 020 0005 080	2 X R0.05	2	8	45	4		2JJCR 030 001 400	3 X R0.1	3	40	80	6	
2JJCR 020 0005 100	2 X R0.05	2	10	50	4		2JJCR 030 002 100	3 X R0.2	3	10	50	6	
2JJCR 020 0005 120	2 X R0.05	2	12	50	4		2JJCR 030 002 120	3 X R0.2	3	12	50	6	
2JJCR 020 0005 140	2 X R0.05	2	14	50	4		2JJCR 030 002 160	3 X R0.2	3	16	55	6	
2JJCR 020 0005 160	2 X R0.05	2	16	50	4		2JJCR 030 002 200	3 X R0.2	3	20	60	6	
2JJCR 020 0005 200	2 X R0.05	2	20	50	4		2JJCR 030 002 250	3 X R0.2	3	25	65	6	
2JJCR 020 0005 250	2 X R0.05	2	25	60	4		2JJCR 030 002 300	3 X R0.2	3	30	70	6	
2JJCR 020 001 060	2 X R0.1	2	6	45	4		2JJCR 030 002 350	3 X R0.2	3	35	75	6	
2JJCR 020 001 080	2 X R0.1	2	8	45	4		2JJCR 030 002 400	3 X R0.2	3	40	80	6	
2JJCR 020 001 100	2 X R0.1	2	10	50	4		2JJCR 030 003 100	3 X R0.3	3	10	50	6	
2JJCR 020 001 120	2 X R0.1	2	12	50	4		2JJCR 030 003 120	3 X R0.3	3	12	50	6	
2JJCR 020 001 140	2 X R0.1	2	14	50	4		2JJCR 030 003 160	3 X R0.3	3	16	55	6	
2JJCR 020 001 160	2 X R0.1	2	16	50	4		2JJCR 030 003 200	3 X R0.3	3	20	60	6	
2JJCR 020 001 200	2 X R0.1	2	20	50	4		2JJCR 030 003 250	3 X R0.3	3	25	65	6	
2JJCR 020 001 250	2 X R0.1	2	25	60	4		2JJCR 030 003 300	3 X R0.3	3	30	70	6	
2JJCR 020 001 300	2 X R0.1	2	30	70	4		2JJCR 030 003 350	3 X R0.3	3	35	75	6	
2JJCR 020 002 060	2 X R0.2	2	6	45	4		2JJCR 030 003 400	3 X R0.3	3	40	80	6	
2JJCR 020 002 080	2 X R0.2	2	8	45	4		2JJCR 030 005 100	3 X R0.5	3	10	50	6	
2JJCR 020 002 100	2 X R0.2	2	10	50	4		2JJCR 030 005 120	3 X R0.5	3	12	50	6	
2JJCR 020 002 120	2 X R0.2	2	12	50	4		2JJCR 030 005 160	3 X R0.5	3	16	55	6	
2JJCR 020 002 140	2 X R0.2	2	14	50	4		2JJCR 030 005 200	3 X R0.5	3	20	60	6	
2JJCR 020 002 160	2 X R0.2	2	16	50	4		2JJCR 030 005 250	3 X R0.5	3	25	65	6	
2JJCR 020 002 200	2 X R0.2	2	20	50	4		2JJCR 030 005 300	3 X R0.5	3	30	70	6	
2JJCR 020 002 250	2 X R0.2	2	25	60	4		2JJCR 030 005 350	3 X R0.5	3	35	75	6	
2JJCR 020 002 300	2 X R0.2	2	30	70	4		2JJCR 030 005 400	3 X R0.5	3	40	80	6	
2JJCR 020 003 060	2 X R0.3	2	6	45	4		2JJCR 030 010 100	3 X R1	3	10	50	6	
2JJCR 020 003 080	2 X R0.3	2	8	45	4		2JJCR 030 010 120	3 X R1	3	12	50	6	
2JJCR 020 003 100	2 X R0.3	2	10	50	4		2JJCR 030 010 160	3 X R1	3	16	55	6	
2JJCR 020 003 120	2 X R0.3	2	12	50	4		2JJCR 030 010 200	3 X R1	3	20	60	6	
2JJCR 020 003 140	2 X R0.3	2	14	50	4		2JJCR 030 010 250	3 X R1	3	25	65	6	
2JJCR 020 003 160	2 X R0.3	2	16	50	4		2JJCR 030 010 300	3 X R1	3	30	70	6	
2JJCR 020 003 200	2 X R0.3	2	20	50	4		2JJCR 030 010 350	3 X R1	3	35	75	6	
2JJCR 020 003 250	2 X R0.3	2	25	60	4		2JJCR 030 010 400	3 X R1	3	40	80	6	
2JJCR 020 003 300	2 X R0.3	2	30	70	4		2JJCR 040 001 120	4 X R0.1	4	12	50	6	
2JJCR 020 005 060	2 X R0.5	2	6	45	4		2JJCR 040 001 160	4 X R0.1	4	16	55	6	
2JJCR 020 005 080	2 X R0.5	2	8	45	4		2JJCR 040 001 200	4 X R0.1	4	20	60	6	
2JJCR 020 005 100	2 X R0.5	2	10	50	4		2JJCR 040 001 250	4 X R0.1	4	25	65	6	
2JJCR 020 005 120	2 X R0.5	2	12	50	4		2JJCR 040 001 300	4 X R0.1	4	30	70	6	
2JJCR 020 005 140	2 X R0.5	2	14	50	4		2JJCR 040 001 350	4 X R0.1	4	35	75	6	
2JJCR 020 005 160	2 X R0.5	2	16	50	4		2JJCR 040 001 400	4 X R0.1	4	40	80	6	
2JJCR 020 005 200	2 X R0.5	2	20	50	4		2JJCR 040 002 120	4 X R0.2	4	12	50	6	
2JJCR 020 005 250	2 X R0.5	2	25	60	4		2JJCR 040 002 160	4 X R0.2	4	16	55	6	
2JJCR 020 005 300	2 X R0.5	2	30	70	4		2JJCR 040 002 200	4 X R0.2	4	20	60	6	
2JJCR 025 001 100	2.5 X R0.1	2.5	10	50	4		2JJCR 040 002 250	4 X R0.2	4	25	65	6	
2JJCR 025 001 160	2.5 X R0.1	2.5	16	50	4		2JJCR 040 002 300	4 X R0.2	4	30	70	6	
2JJCR 025 001 200	2.5 X R0.1	2.5	20	50	4		2JJCR 040 002 350	4 X R0.2	4	35	75	6	
2JJCR 025 001 250	2.5 X R0.1	2.5	25	60	4		2JJCR 040 002 400	4 X R0.2	4	40	80	6	
2JJCR 025 001 300	2.5 X R0.1	2.5	30	70	4		2JJCR 040 003 120	4 X R0.3	4	12	50	6	
2JJCR 025 002 100	2.5 X R0.2	2.5	10	50	4		2JJCR 040 003 160	4 X R0.3	4	16	55	6	
2JJCR 025 002 160	2.5 X R0.2	2.5	16	50	4		2JJCR 040 003 200	4 X R0.3	4	20	60	6	

단위 : mm

Order Number	날경 Diameter D × R	날장 Length of cut L1	유효장 Effective Length L2	전장 Overall Length L	샙크 Dia d	비고	Order Number	날경 Diameter D × R	날장 Length of cut L1	유효장 Effective Length L2	전장 Overall Length L	샙크 Dia d	비고
2JJCR 040 003 250	4 X R0.3	4	25	65	6								
2JJCR 040 003 300	4 X R0.3	4	30	70	6								
2JJCR 040 003 350	4 X R0.3	4	35	75	6								
2JJCR 040 003 400	4 X R0.3	4	40	80	6								
2JJCR 040 005 120	4 X R0.5	4	12	50	6								
2JJCR 040 005 160	4 X R0.5	4	16	55	6								
2JJCR 040 005 200	4 X R0.5	4	20	60	6								
2JJCR 040 005 250	4 X R0.5	4	25	65	6								
2JJCR 040 005 300	4 X R0.5	4	30	70	6								
2JJCR 040 005 350	4 X R0.5	4	35	75	6								
2JJCR 040 005 400	4 X R0.5	4	40	80	6								
2JJCR 040 010 120	4 X R1	4	12	50	6								
2JJCR 040 010 160	4 X R1	4	16	55	6								
2JJCR 040 010 200	4 X R1	4	20	60	6								
2JJCR 040 010 250	4 X R1	4	25	65	6								
2JJCR 040 010 300	4 X R1	4	30	70	6								
2JJCR 040 010 350	4 X R1	4	35	75	6								
2JJCR 040 010 400	4 X R1	4	40	80	6								
2JJCR 050 002 150	5 X R0.2	6	15	60	6								
2JJCR 050 002 250	5 X R0.2	6	25	70	6								
2JJCR 050 002 300	5 X R0.2	6	30	70	6								
2JJCR 050 002 400	5 X R0.2	6	40	80	6								
2JJCR 050 005 150	5 X R0.5	6	15	60	6								
2JJCR 050 005 250	5 X R0.5	6	25	70	6								
2JJCR 050 005 300	5 X R0.5	6	30	70	6								
2JJCR 050 005 400	5 X R0.5	6	40	80	6								
2JJCR 050 010 150	5 X R1	6	15	60	6								
2JJCR 050 010 250	5 X R1	6	25	70	6								
2JJCR 050 010 300	5 X R1	6	30	70	6								
2JJCR 050 010 400	5 X R1	6	40	80	6								
2JJCR 060 001 200	6 X R0.1	7	20	60	6								
2JJCR 060 001 400	6 X R0.1	7	40	80	6								
2JJCR 060 002 200	6 X R0.2	7	20	60	6								
2JJCR 060 002 400	6 X R0.2	7	40	80	6								
2JJCR 060 003 200	6 X R0.3	7	20	60	6								
2JJCR 060 003 400	6 X R0.3	7	40	80	6								
2JJCR 060 005 200	6 X R0.5	7	20	60	6								
2JJCR 060 005 400	6 X R0.5	7	40	80	6								
2JJCR 060 010 200	6 X R1	7	20	60	6								
2JJCR 060 010 400	6 X R1	7	40	80	6								
2JJCR 060 015 200	6 X R1.5	7	20	60	6								
2JJCR 060 015 400	6 X R1.5	7	40	80	6								
2JJCR 080 002 220	8 X R0.2	9	22	65	8								
2JJCR 080 003 220	8 X R0.3	9	22	65	8								
2JJCR 080 005 220	8 X R0.5	9	22	65	8								
2JJCR 080 010 220	8 X R1	9	22	65	8								
2JJCR 080 015 220	8 X R1.5	9	22	65	8								
2JJCR 100 002 240	10 X R0.2	11	24	70	10								
2JJCR 100 003 240	10 X R0.3	11	24	70	10								
2JJCR 100 005 240	10 X R0.5	11	24	70	10								
2JJCR 100 010 240	10 X R1	11	24	70	10								
2JJCR 100 015 240	10 X R1.5	11	24	70	10								
2JJCR 100 020 240	10 X R2	11	24	70	10								
2JJCR 120 002 260	12 X R0.2	13	26	80	12								
2JJCR 120 003 260	12 X R0.3	13	26	80	12								
2JJCR 120 005 260	12 X R0.5	13	26	80	12								
2JJCR 120 010 260	12 X R1	13	26	80	12								
2JJCR 120 015 260	12 X R1.5	13	26	80	12								
2JJCR 120 020 260	12 X R2	13	26	80	12								
2JJCR 120 030 260	12 X R3	13	26	80	12								
2JJCR 160 005 110	16 X R0.5	20	35	110	16								
2JJCR 160 010 110	16 X R1	20	35	110	16								





JJ series

단위: mm

Order Number	날경 Diameter D×R	각도 Angle θ	날장 Length of cut L1	유효장 Effective Length L2	전장 Overall Length L	샙크 Dia d	비고	Order Number	날경 Diameter D×R	각도 Angle θ	날장 Length of cut L1	유효장 Effective Length L2	전장 Overall Length L	샙크 Dia d	비고
2JJTC 040 010 4001	4 X R1	1°	4	40	80	6									
2JJTC 040 010 5001	4 X R1	1°	4	50	90	6									
2JJTC 040 010 6001	4 X R1	1°	4	60	100	6									



### 4날 고정도재 가공용 제이제이 리브 코너 레디우스 엔드밀

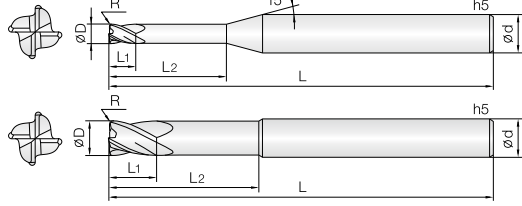

- 고정도강(HRc52~68), 프리하든강 계열의 고정밀 가공 엔드밀
- 고품량 실리콘계 코팅(Si) 처리하여 내마모성이 우수합니다.
- 고정밀 공차 적용으로 초정밀 가공에 적합합니다.
- 코너R 형상을 날부치핑이 적도록 설계하였습니다.
- 다양한 코너R과 유효장으로 맞춤 가공이 가능합니다.
- 초미립자 초경합금(0.2 $\mu$ m)을 채택, 고속절삭시 뛰어난 성능을 발휘합니다.

#### • Endmills for pre-hardened and hardened steels(HRc52~68)

- Good wear resistance by high quality Si-based PVD coating.
- High precise edge tolerance.
- Designed for minimizing edge chipping by corner R shape.
- Various corner R and flute length for wide range application.
- Outstanding performance at high speed machining by ultra fine (0.2 $\mu$ m) WC grade.

Condition	D Size	D Tolerance	Condition	D Size	D Tolerance
∅D ≠ ∅d	∅0.5 ~ 12	+0 ~ -0.01mm	∅D = ∅d	∅6 ~ 12	-0.005 ~ -0.015mm

단위 : mm

Order Number	날경 Diameter D × R	날장 Length of cut L1	유효장 Effective Length L2	전장 Overall Length L	셱크 Shank Dia d	비고
4JJCR 005 0005 020	0.5 X R0.05	0.5	2	45	4	
4JJCR 005 0005 040	0.5 X R0.05	0.5	4	45	4	
4JJCR 005 0005 060	0.5 X R0.05	0.5	6	45	4	
4JJCR 005 0005 080	0.5 X R0.05	0.5	8	45	4	
4JJCR 005 001 020	0.5 X R0.1	0.5	2	45	4	
4JJCR 005 001 040	0.5 X R0.1	0.5	4	45	4	
4JJCR 005 001 060	0.5 X R0.1	0.5	6	45	4	
4JJCR 005 001 080	0.5 X R0.1	0.5	8	45	4	
4JJCR 006 0005 020	0.6 X R0.05	0.6	2	45	4	
4JJCR 006 0005 040	0.6 X R0.05	0.6	4	45	4	
4JJCR 006 0005 060	0.6 X R0.05	0.6	6	45	4	
4JJCR 006 0005 080	0.6 X R0.05	0.6	8	45	4	
4JJCR 006 001 020	0.6 X R0.1	0.6	2	45	4	
4JJCR 006 001 040	0.6 X R0.1	0.6	4	45	4	
4JJCR 006 001 060	0.6 X R0.1	0.6	6	45	4	
4JJCR 006 001 080	0.6 X R0.1	0.6	8	45	4	
4JJCR 007 0005 020	0.7 X R0.05	0.7	2	45	4	
4JJCR 007 0005 040	0.7 X R0.05	0.7	4	45	4	
4JJCR 007 0005 060	0.7 X R0.05	0.7	6	45	4	
4JJCR 007 0005 080	0.7 X R0.05	0.7	8	45	4	
4JJCR 007 001 020	0.7 X R0.1	0.7	2	45	4	
4JJCR 007 001 040	0.7 X R0.1	0.7	4	45	4	
4JJCR 007 001 060	0.7 X R0.1	0.7	6	45	4	
4JJCR 007 001 080	0.7 X R0.1	0.7	8	45	4	
4JJCR 008 0002 020	0.8 X R0.02	0.8	2	45	4	
4JJCR 008 0002 040	0.8 X R0.02	0.8	4	45	4	
4JJCR 008 0002 060	0.8 X R0.02	0.8	6	45	4	
4JJCR 008 0002 080	0.8 X R0.02	0.8	8	45	4	
4JJCR 008 0002 100	0.8 X R0.02	0.8	10	45	4	
4JJCR 008 0002 120	0.8 X R0.02	0.8	12	50	4	
4JJCR 008 0005 020	0.8 X R0.05	0.8	2	45	4	
4JJCR 008 0005 040	0.8 X R0.05	0.8	4	45	4	
4JJCR 008 0005 060	0.8 X R0.05	0.8	6	45	4	
4JJCR 008 0005 080	0.8 X R0.05	0.8	8	45	4	
4JJCR 008 0005 100	0.8 X R0.05	0.8	10	45	4	
4JJCR 008 0005 120	0.8 X R0.05	0.8	12	50	4	
4JJCR 008 001 020	0.8 X R0.1	0.8	2	45	4	
4JJCR 008 001 040	0.8 X R0.1	0.8	4	45	4	
4JJCR 008 001 060	0.8 X R0.1	0.8	6	45	4	
4JJCR 008 001 080	0.8 X R0.1	0.8	8	45	4	
4JJCR 008 001 100	0.8 X R0.1	0.8	10	45	4	
4JJCR 008 001 120	0.8 X R0.1	0.8	12	50	4	
4JJCR 010 0002 040	1 X R0.02	1	4	45	4	
4JJCR 010 0002 060	1 X R0.02	1	6	45	4	
4JJCR 010 0002 080	1 X R0.02	1	8	45	4	
4JJCR 010 0002 100	1 X R0.02	1	10	50	4	
4JJCR 010 0002 120	1 X R0.02	1	12	50	4	
4JJCR 010 0002 140	1 X R0.02	1	14	50	4	
4JJCR 010 0002 160	1 X R0.02	1	16	50	4	
4JJCR 010 0002 200	1 X R0.02	1	20	50	4	

Order Number	날경 Diameter D × R	날장 Length of cut L1	유효장 Effective Length L2	전장 Overall Length L	셱크 Shank Dia d	비고
4JJCR 010 0005 040	1 X R0.05	1	4	45	4	
4JJCR 010 0005 060	1 X R0.05	1	6	45	4	
4JJCR 010 0005 080	1 X R0.05	1	8	45	4	
4JJCR 010 0005 100	1 X R0.05	1	10	50	4	
4JJCR 010 0005 120	1 X R0.05	1	12	50	4	
4JJCR 010 0005 140	1 X R0.05	1	14	50	4	
4JJCR 010 0005 160	1 X R0.05	1	16	50	4	
4JJCR 010 0005 200	1 X R0.05	1	20	50	4	
4JJCR 010 001 040	1 X R0.1	1	4	45	4	
4JJCR 010 001 060	1 X R0.1	1	6	45	4	
4JJCR 010 001 080	1 X R0.1	1	8	45	4	
4JJCR 010 001 100	1 X R0.1	1	10	50	4	
4JJCR 010 001 120	1 X R0.1	1	12	50	4	
4JJCR 010 001 140	1 X R0.1	1	14	50	4	
4JJCR 010 001 160	1 X R0.1	1	16	50	4	
4JJCR 010 001 200	1 X R0.1	1	20	50	4	
4JJCR 010 002 040	1 X R0.2	1	4	45	4	
4JJCR 010 002 060	1 X R0.2	1	6	45	4	
4JJCR 010 002 080	1 X R0.2	1	8	45	4	
4JJCR 010 002 100	1 X R0.2	1	10	50	4	
4JJCR 010 002 120	1 X R0.2	1	12	50	4	
4JJCR 010 002 140	1 X R0.2	1	14	50	4	
4JJCR 010 002 160	1 X R0.2	1	16	50	4	
4JJCR 010 002 200	1 X R0.2	1	20	50	4	
4JJCR 010 003 040	1 X R0.3	1	4	45	4	
4JJCR 010 003 060	1 X R0.3	1	6	45	4	
4JJCR 010 003 080	1 X R0.3	1	8	45	4	
4JJCR 010 003 100	1 X R0.3	1	10	50	4	
4JJCR 010 003 120	1 X R0.3	1	12	50	4	
4JJCR 010 003 140	1 X R0.3	1	14	50	4	
4JJCR 010 003 160	1 X R0.3	1	16	50	4	
4JJCR 010 003 200	1 X R0.3	1	20	50	4	
4JJCR 012 0002 040	1.2 X R0.02	1.2	4	45	4	
4JJCR 012 0002 060	1.2 X R0.02	1.2	6	45	4	
4JJCR 012 0002 080	1.2 X R0.02	1.2	8	45	4	
4JJCR 012 0002 100	1.2 X R0.02	1.2	10	50	4	
4JJCR 012 0002 120	1.2 X R0.02	1.2	12	50	4	
4JJCR 012 0002 140	1.2 X R0.02	1.2	14	50	4	
4JJCR 012 0002 160	1.2 X R0.02	1.2	16	50	4	
4JJCR 012 0002 200	1.2 X R0.02	1.2	20	50	4	
4JJCR 012 0005 040	1.2 X R0.05	1.2	4	45	4	
4JJCR 012 0005 060	1.2 X R0.05	1.2	6	45	4	
4JJCR 012 0005 080	1.2 X R0.05	1.2	8	45	4	
4JJCR 012 0005 100	1.2 X R0.05	1.2	10	50	4	
4JJCR 012 0005 120	1.2 X R0.05	1.2	12	50	4	
4JJCR 012 0005 140	1.2 X R0.05	1.2	14	50	4	
4JJCR 012 0005 160	1.2 X R0.05	1.2	16	50	4	
4JJCR 012 0005 200	1.2 X R0.05	1.2	20	50	4	
4JJCR 012 001 040	1.2 X R0.1	1.2	4	45	4	
4JJCR 012 001 060	1.2 X R0.1	1.2	6	45	4	







단위 : mm

Order Number	날경 Diameter D×R	날장 Length of cut L1	유효장 Effective Length L2	전장 Overall Length L	샙크 Shank Dia d	비고	Order Number	날경 Diameter D×R	날장 Length of cut L1	유효장 Effective Length L2	전장 Overall Length L	샙크 Shank Dia d	비고
4JJCR 060 001 400	6 X R0.1	7	40	80	6		4JJCR 120 015 260	12 X R1.5	13	26	80	12	
4JJCR 060 001 500	6 X R0.1	7	50	100	6		4JJCR 120 020 260	12 X R2	13	26	80	12	
4JJCR 060 002 200	6 X R0.2	7	20	60	6		4JJCR 120 020 400	12 X R2	13	40	110	12	
4JJCR 060 002 400	6 X R0.2	7	40	80	6		4JJCR 120 030 260	12 X R3	13	26	80	12	
4JJCR 060 002 500	6 X R0.2	7	50	100	6								
4JJCR 060 003 200	6 X R0.3	7	20	60	6								
4JJCR 060 003 400	6 X R0.3	7	40	80	6								
4JJCR 060 003 500	6 X R0.3	7	50	100	6								
4JJCR 060 005 200	6 X R0.5	7	20	60	6								
4JJCR 060 005 400	6 X R0.5	7	40	80	6								
4JJCR 060 005 500	6 X R0.5	7	50	100	6								
4JJCR 060 005 600	6 X R0.5	7	60	110	6								
4JJCR 060 010 200	6 X R1	7	20	60	6								
4JJCR 060 010 400	6 X R1	7	40	80	6								
4JJCR 060 010 500	6 X R1	7	50	100	6								
4JJCR 060 010 600	6 X R1	7	60	110	6								
4JJCR 060 015 200	6 X R1.5	7	20	60	6								
4JJCR 060 015 400	6 X R1.5	7	40	80	6								
4JJCR 060 015 500	6 X R1.5	7	50	100	6								
4JJCR 060 020 300	6 X R2	7	30	70	6								
4JJCR 060 020 400	6 X R2	7	40	80	6								
4JJCR 060 020 500	6 X R2	7	50	100	6								
4JJCR 080 002 220	8 X R0.2	9	22	65	8								
4JJCR 080 002 400	8 X R0.2	9	40	100	8								
4JJCR 080 003 220	8 X R0.3	9	22	65	8								
4JJCR 080 003 400	8 X R0.3	9	40	100	8								
4JJCR 080 005 220	8 X R0.5	9	22	65	8								
4JJCR 080 005 400	8 X R0.5	9	40	100	8								
4JJCR 080 005 500	8 X R0.5	9	50	120	8								
4JJCR 080 005 600	8 X R0.5	9	60	120	8								
4JJCR 080 010 220	8 X R1	9	22	65	8								
4JJCR 080 010 400	8 X R1	9	40	100	8								
4JJCR 080 010 500	8 X R1	9	50	120	8								
4JJCR 080 010 600	8 X R1	9	60	120	8								
4JJCR 080 015 220	8 X R1.5	9	22	65	8								
4JJCR 080 015 400	8 X R1.5	9	40	100	8								
4JJCR 080 020 220	8 X R2	9	22	65	8								
4JJCR 080 020 400	8 X R2	9	40	100	8								
4JJCR 080 020 500	8 X R2	9	50	120	8								
4JJCR 100 002 240	10 X R0.2	11	24	70	10								
4JJCR 100 002 400	10 X R0.2	11	40	100	10								
4JJCR 100 003 240	10 X R0.3	11	24	70	10								
4JJCR 100 003 400	10 X R0.3	11	40	100	10								
4JJCR 100 005 240	10 X R0.5	11	24	70	10								
4JJCR 100 005 400	10 X R0.5	11	40	100	10								
4JJCR 100 005 500	10 X R0.5	11	50	120	10								
4JJCR 100 005 600	10 X R0.5	11	60	120	10								
4JJCR 100 010 240	10 X R1	11	24	70	10								
4JJCR 100 010 400	10 X R1	11	40	100	10								
4JJCR 100 010 500	10 X R1	11	50	120	10								
4JJCR 100 010 600	10 X R1	11	60	120	10								
4JJCR 100 015 240	10 X R1.5	11	24	70	10								
4JJCR 100 015 400	10 X R1.5	11	40	100	10								
4JJCR 100 020 240	10 X R2	11	24	70	10								
4JJCR 100 020 400	10 X R2	11	40	100	10								
4JJCR 100 020 500	10 X R2	11	50	120	10								
4JJCR 100 025 240	10 X R2.5	11	24	70	10								
4JJCR 120 003 260	12 X R0.3	13	26	80	12								
4JJCR 120 005 260	12 X R0.5	13	26	80	12								
4JJCR 120 005 400	12 X R0.5	13	40	110	12								
4JJCR 120 005 600	12 X R0.5	13	60	130	12								
4JJCR 120 010 260	12 X R1	13	26	80	12								
4JJCR 120 010 400	12 X R1	13	40	110	12								
4JJCR 120 010 600	12 X R1	13	60	130	12								





단위 : mm

Order Number	날경 Diameter D×R	날장 Length of cut L1	유효장 Effective Length L2	전장 Overall Length L	샙크 Shank Dia d	비고	Order Number	날경 Diameter D×R	날장 Length of cut L1	유효장 Effective Length L2	전장 Overall Length L	샙크 Shank Dia d	비고
6JJCR 120 003 560	12 X R0.3	12	56	110	12								
6JJCR 120 005 360	12 X R0.5	12	36	90	12								
6JJCR 120 005 460	12 X R0.5	12	46	100	12								
6JJCR 120 005 560	12 X R0.5	12	56	110	12								
6JJCR 120 010 360	12 X R1	12	36	90	12								
6JJCR 120 010 460	12 X R1	12	46	100	12								
6JJCR 120 010 560	12 X R1	12	56	110	12								







단위 : mm

Order Number	날경 Diameter D × R	날장 Length of cut L1	전장 Overall Length L	생크 Shank Dia d	비고	Order Number	날경 Diameter D × R	날장 Length of cut L1	전장 Overall Length L	생크 Shank Dia d	비고
2JJC 080 015 100	8 X R1.5	19	100	8							
2JJC 080 020 070	8 X R2	16	70	8							
2JJC 080 020 100	8 X R2	19	100	8							
2JJC 080 025 100	8 X R2.5	19	100	8							
2JJC 080 030 100	8 X R3	19	100	8							
2JJC 080 035 100	8 X R3.5	19	100	8							
2JJC 100 001 075	10 X R0.1	19	75	10							
2JJC 100 001 100	10 X R0.1	22	100	10							
2JJC 100 002 075	10 X R0.2	19	75	10							
2JJC 100 002 100	10 X R0.2	22	100	10							
2JJC 100 003 075	10 X R0.3	19	75	10							
2JJC 100 003 100	10 X R0.3	22	100	10							
2JJC 100 005 075	10 X R0.5	19	75	10							
2JJC 100 005 100	10 X R0.5	22	100	10							
2JJC 100 005 120	10 X R0.5	22	120	10							
2JJC 100 010 075	10 X R1	19	75	10							
2JJC 100 010 100	10 X R1	22	100	10							
2JJC 100 010 120	10 X R1	22	120	10							
2JJC 100 015 075	10 X R1.5	19	75	10							
2JJC 100 015 100	10 X R1.5	22	100	10							
2JJC 100 020 075	10 X R2	19	75	10							
2JJC 100 020 100	10 X R2	22	100	10							
2JJC 100 025 100	10 X R2.5	22	100	10							
2JJC 100 030 100	10 X R3	22	100	10							
2JJC 100 040 100	10 X R4	22	100	10							
2JJC 120 001 080	12 X R0.1	22	80	12							
2JJC 120 001 110	12 X R0.1	26	110	12							
2JJC 120 002 080	12 X R0.2	22	80	12							
2JJC 120 002 110	12 X R0.2	26	110	12							
2JJC 120 003 080	12 X R0.3	22	80	12							
2JJC 120 003 110	12 X R0.3	26	110	12							
2JJC 120 005 080	12 X R0.5	22	80	12							
2JJC 120 005 110	12 X R0.5	26	110	12							
2JJC 120 005 130	12 X R0.5	26	130	12							
2JJC 120 010 080	12 X R1	22	80	12							
2JJC 120 010 110	12 X R1	26	110	12							
2JJC 120 010 130	12 X R1	26	130	12							
2JJC 120 015 080	12 X R1.5	22	80	12							
2JJC 120 015 110	12 X R1.5	26	110	12							
2JJC 120 020 080	12 X R2	22	80	12							
2JJC 120 020 110	12 X R2	26	110	12							
2JJC 120 020 130	12 X R2	26	130	12							
2JJC 120 025 110	12 X R2.5	26	110	12							
2JJC 120 030 110	12 X R3	26	110	12							
2JJC 120 040 110	12 X R4	26	110	12							
2JJC 120 050 110	12 X R5	26	110	12							
2JJC 140 005 110	14 X R0.5	30	110	14							
2JJC 140 010 110	14 X R1	30	110	14							
2JJC 140 020 110	14 X R2	30	110	14							







단위 : mm

Order Number	날경 Diameter D×R	날장 Length of cut L1	전장 Overall Length L	샙크 Dia d	비고	Order Number	날경 Diameter D×R	날장 Length of cut L1	전장 Overall Length L	샙크 Dia d	비고
4JJC 080 003 060	8 X R0.3	16	60	8		4JJC 120 005 110	12 X R0.5	26	110	12	
4JJC 080 003 090	8 X R0.3	19	90	8		4JJC 120 005 130	12 X R0.5	26	130	12	
4JJC 080 005 060	8 X R0.5	16	60	8		4JJC 120 005 160	12 X R0.5	26	160	12	
4JJC 080 005 090	8 X R0.5	19	90	8		4JJC 120 010 075	12 X R1	22	75	12	
4JJC 080 005 110	8 X R0.5	19	110	8		4JJC 120 010 110	12 X R1	26	110	12	
4JJC 080 005 150	8 X R0.5	19	150	8		4JJC 120 010 130	12 X R1	26	130	12	
4JJC 080 010 060	8 X R1	16	60	8		4JJC 120 010 160	12 X R1	26	160	12	
4JJC 080 010 090	8 X R1	19	90	8		4JJC 120 015 075	12 X R1.5	22	75	12	
4JJC 080 010 110	8 X R1	19	110	8		4JJC 120 015 110	12 X R1.5	26	110	12	
4JJC 080 010 150	8 X R1	19	150	8		4JJC 120 020 075	12 X R2	22	75	12	
4JJC 080 015 060	8 X R1.5	16	60	8		4JJC 120 020 110	12 X R2	26	110	12	
4JJC 080 015 090	8 X R1.5	19	90	8		4JJC 120 020 130	12 X R2	26	130	12	
4JJC 080 020 060	8 X R2	16	60	8		4JJC 120 020 160	12 X R2	26	160	12	
4JJC 080 020 090	8 X R2	19	90	8		4JJC 120 025 075	12 X R2.5	22	75	12	
4JJC 090 002 S10	9 X R0.2	20	90	10		4JJC 120 025 110	12 X R2.5	26	110	12	
4JJC 090 003 S10	9 X R0.3	20	90	10		4JJC 120 030 075	12 X R3	22	75	12	
4JJC 090 005 S10	9 X R0.5	20	90	10		4JJC 120 030 110	12 X R3	26	110	12	
4JJC 090 010 S10	9 X R1	20	90	10		4JJC 140 005 110	14 X R0.5	30	110	14	
4JJC 100 001 070	10 X R0.1	19	70	10		4JJC 140 010 110	14 X R1	30	110	14	
4JJC 100 001 100	10 X R0.1	22	100	10		4JJC 140 020 110	14 X R2	30	110	14	
4JJC 100 002 070	10 X R0.2	19	70	10		4JJC 160 005 110	16 X R0.5	32	110	16	
4JJC 100 002 100	10 X R0.2	22	100	10		4JJC 160 005 160	16 X R0.5	32	160	16	
4JJC 100 003 070	10 X R0.3	19	70	10		4JJC 160 010 110	16 X R1	32	110	16	
4JJC 100 003 100	10 X R0.3	22	100	10		4JJC 160 010 160	16 X R1	32	160	16	
4JJC 100 005 070	10 X R0.5	19	70	10							
4JJC 100 005 100	10 X R0.5	22	100	10							
4JJC 100 005 120	10 X R0.5	22	120	10							
4JJC 100 005 150	10 X R0.5	22	150	10							
4JJC 100 010 070	10 X R1	19	70	10							
4JJC 100 010 100	10 X R1	22	100	10							
4JJC 100 010 120	10 X R1	22	120	10							
4JJC 100 010 150	10 X R1	22	150	10							
4JJC 100 015 070	10 X R1.5	19	70	10							
4JJC 100 015 100	10 X R1.5	22	100	10							
4JJC 100 020 070	10 X R2	19	70	10							
4JJC 100 020 100	10 X R2	22	100	10							
4JJC 100 020 120	10 X R2	22	120	10							
4JJC 100 020 150	10 X R2	22	150	10							
4JJC 100 025 070	10 X R2.5	19	70	10							
4JJC 100 025 100	10 X R2.5	22	100	10							
4JJC 110 003 S12	11 X R0.3	24	100	12							
4JJC 110 005 S12	11 X R0.5	24	100	12							
4JJC 110 010 S12	11 X R1	24	100	12							
4JJC 120 001 075	12 X R0.1	22	75	12							
4JJC 120 001 110	12 X R0.1	26	110	12							
4JJC 120 002 075	12 X R0.2	22	75	12							
4JJC 120 002 110	12 X R0.2	26	110	12							
4JJC 120 003 075	12 X R0.3	22	75	12							
4JJC 120 003 110	12 X R0.3	26	110	12							
4JJC 120 005 075	12 X R0.5	22	75	12							

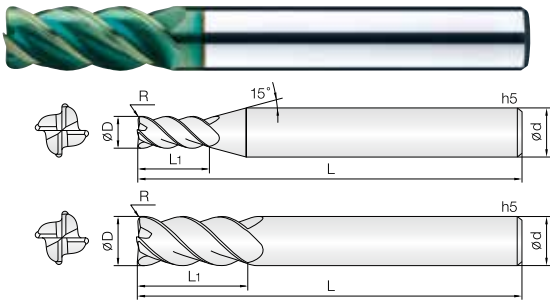

- 고정도강(HRc52~68), 프리하든강 계열의 고정밀 가공 엔드밀
- 고품질 실리콘계 코팅(Si) 처리하여 내마모성이 우수합니다.
- 고정밀 공차 적용으로 초정밀 가공에 적합합니다.
- 코너R 형상을 날부치핑이 적도록 설계하였습니다.
- 45° 헬릭스 형상으로 설계하여 고속, 고이송 가공에 적합합니다.
- 초미립자 초경합금(0.2µm)을 채택, 고속절삭시 뛰어난 성능을 발휘합니다.

#### Endmills for pre-hardened and hardened steels(HRc52~68)

- Good wear resistance by high quality Si-based PVD coating.
- High precise edge tolerance.
- Designed for minimizing edge chipping by corner R shape.
- 45° degree helix design for high speed, feed condition.
- Outstanding performance at high speed machining by ultra fine (0.2µm) WC grade.

4

UWC  
초미립자

TISIN-S  
Coating

R  
± 0.005

R  
± 0.01

R  
± 0.015

45°  
Helix Angle

CUTTING  
DATA

R0.05 ~ 0.5    R1 ~ 1.5    R2 ~ 5    419P

Condition	D Size	D Tolerance	Condition	D Size	D Tolerance
ØD ≠ Ød	Ø1 ~ 20	+0 ~ -0.01mm	ØD = Ød	Ø6 ~ 12	-0.005 ~ -0.015mm
				Ø14 ~ 20	-0.01 ~ -0.02mm

단위 : mm

Order Number	날경 Diameter D × R	날장 Length of cut L1	전장 Overall Length L	샙크 Shank Dia d	비고	Order Number	날경 Diameter D × R	날장 Length of cut L1	전장 Overall Length L	샙크 Shank Dia d	비고
4JJCR 010 0005 050	1 X R0.05	2	50	6		4JJCR 080 002 070	8 X R0.2	16	70	8	
4JJCR 010 001 050	1 X R0.1	2	50	6		4JJCR 080 002 090	8 X R0.2	19	90	8	
4JJCR 010 002 050	1 X R0.2	2	50	6		4JJCR 080 003 070	8 X R0.3	16	70	8	
4JJCR 010 003 050	1 X R0.3	2	50	6		4JJCR 080 003 090	8 X R0.3	19	90	8	
4JJCR 012 0005 050	1.2 X R0.05	2.5	50	6		4JJCR 080 005 070	8 X R0.5	16	70	8	
4JJCR 012 001 050	1.2 X R0.1	2.5	50	6		4JJCR 080 005 090	8 X R0.5	19	90	8	
4JJCR 012 002 050	1.2 X R0.2	2.5	50	6		4JJCR 080 010 070	8 X R1	16	70	8	
4JJCR 012 003 050	1.2 X R0.3	2.5	50	6		4JJCR 080 010 090	8 X R1	19	90	8	
4JJCR 015 0005 050	1.5 X R0.05	3	50	6		4JJCR 080 015 070	8 X R1.5	16	70	8	
4JJCR 015 001 050	1.5 X R0.1	3	50	6		4JJCR 080 015 090	8 X R1.5	19	90	8	
4JJCR 015 002 050	1.5 X R0.2	3	50	6		4JJCR 080 020 070	8 X R2	16	70	8	
4JJCR 015 003 050	1.5 X R0.3	3	50	6		4JJCR 080 020 090	8 X R2	19	90	8	
4JJCR 015 005 050	1.5 X R0.5	3	50	6		4JJCR 100 002 075	10 X R0.2	20	75	10	
4JJCR 020 001 050	2 X R0.1	5	50	6		4JJCR 100 002 100	10 X R0.2	23	100	10	
4JJCR 020 002 050	2 X R0.2	5	50	6		4JJCR 100 003 075	10 X R0.3	20	75	10	
4JJCR 020 003 050	2 X R0.3	5	50	6		4JJCR 100 003 100	10 X R0.3	23	100	10	
4JJCR 020 005 050	2 X R0.5	5	50	6		4JJCR 100 005 075	10 X R0.5	20	75	10	
4JJCR 025 001 060	2.5 X R0.1	6	60	6		4JJCR 100 005 100	10 X R0.5	23	100	10	
4JJCR 025 002 060	2.5 X R0.2	6	60	6		4JJCR 100 010 075	10 X R1	20	75	10	
4JJCR 025 003 060	2.5 X R0.3	6	60	6		4JJCR 100 010 100	10 X R1	23	100	10	
4JJCR 025 005 060	2.5 X R0.5	6	60	6		4JJCR 100 015 075	10 X R1.5	20	75	10	
4JJCR 030 001 070	3 X R0.1	6	70	6		4JJCR 100 015 100	10 X R1.5	23	100	10	
4JJCR 030 002 070	3 X R0.2	6	70	6		4JJCR 100 020 075	10 X R2	20	75	10	
4JJCR 030 003 070	3 X R0.3	6	70	6		4JJCR 100 020 100	10 X R2	23	100	10	
4JJCR 030 005 070	3 X R0.5	6	70	6		4JJCR 120 003 080	12 X R0.3	23	80	12	
4JJCR 030 010 070	3 X R1	6	70	6		4JJCR 120 003 110	12 X R0.3	27	110	12	
4JJCR 040 001 070	4 X R0.1	8	70	6		4JJCR 120 005 080	12 X R0.5	23	80	12	
4JJCR 040 002 070	4 X R0.2	8	70	6		4JJCR 120 005 110	12 X R0.5	27	110	12	
4JJCR 040 003 070	4 X R0.3	8	70	6		4JJCR 120 010 080	12 X R1	23	80	12	
4JJCR 040 005 070	4 X R0.5	8	70	6		4JJCR 120 010 110	12 X R1	27	110	12	
4JJCR 040 010 070	4 X R1	8	70	6		4JJCR 120 015 080	12 X R1.5	23	80	12	
4JJCR 050 001 080	5 X R0.1	10	80	6		4JJCR 120 015 110	12 X R1.5	27	110	12	
4JJCR 050 002 080	5 X R0.2	10	80	6		4JJCR 120 020 080	12 X R2	23	80	12	
4JJCR 050 003 080	5 X R0.3	10	80	6		4JJCR 120 020 110	12 X R2	27	110	12	
4JJCR 050 005 080	5 X R0.5	10	80	6		4JJCR 120 030 080	12 X R3	23	80	12	
4JJCR 050 010 080	5 X R1	10	80	6		4JJCR 120 030 110	12 X R3	27	110	12	
4JJCR 060 001 060	6 X R0.1	12	60	6		4JJCR 140 005 110	14 X R0.5	30	110	14	
4JJCR 060 001 080	6 X R0.1	15	80	6		4JJCR 140 010 110	14 X R1	30	110	14	
4JJCR 060 002 060	6 X R0.2	12	60	6		4JJCR 140 020 110	14 X R2	30	110	14	
4JJCR 060 002 080	6 X R0.2	15	80	6		4JJCR 160 005 120	16 X R0.5	32	120	16	
4JJCR 060 003 060	6 X R0.3	12	60	6		4JJCR 160 010 120	16 X R1	32	120	16	
4JJCR 060 003 080	6 X R0.3	15	80	6		4JJCR 160 020 120	16 X R2	32	120	16	
4JJCR 060 005 060	6 X R0.5	12	60	6		4JJCR 160 030 120	16 X R3	32	120	16	
4JJCR 060 005 080	6 X R0.5	15	80	6		4JJCR 200 005 130	20 X R0.5	38	130	20	
4JJCR 060 010 060	6 X R1	12	60	6		4JJCR 200 010 130	20 X R1	38	130	20	
4JJCR 060 010 080	6 X R1	15	80	6		4JJCR 200 020 130	20 X R2	38	130	20	
4JJCR 060 015 060	6 X R1.5	12	60	6		4JJCR 200 030 130	20 X R3	38	130	20	
4JJCR 060 015 080	6 X R1.5	15	80	6		4JJCR 200 040 130	20 X R4	38	130	20	
4JJCR 060 020 060	6 X R2	12	60	6		4JJCR 200 050 130	20 X R5	38	130	20	
4JJCR 060 020 080	6 X R2	15	80	6							

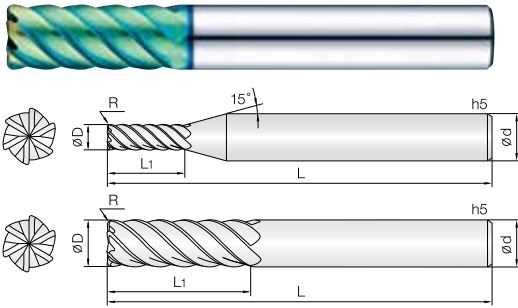

- 고정도강(HRc52~68), 프리하든강 계열의 고정밀 가공 엔드밀
- 고품량 실리콘계 코팅(Si) 처리하여 내마모성이 우수합니다.
- 45° 헬릭스 형상으로 설계하여 고속, 고이송 가공에 적합합니다.
- 측벽 가공, 코너부, 무구배면 가공시 가공물의 표면조도가 뛰어나며, 인선날 길이 증가로 내마모성이 더욱 좋아집니다.
- 초미립자 초경합금(0.2 $\mu$ m)을 채택, 고속절삭시 뛰어난 성능을 발휘합니다.

#### • Endmills for pre-hardened and hardened steels(HRc52~68)

- Good wear resistance by high quality Si-based PVD coating.
- 45° degree helix design for high speed, feed condition.
- Excellent surface roughness for side, corner, shoulder milling and improved wear resistance due to increased edge length.
- Outstanding performance at high speed machining by ultra fine (0.2 $\mu$ m) WC grade.

6

UWC  
초미립자

TISIN-S  
Coating

R  
±0.005

R  
±0.01

R  
±0.015

45°  
Helix Angle

CUTTING  
DATA

R0.1 ~ 0.5    R1 ~ 1.5    R2    419P

Condition	D Size	D Tolerance	Condition	D Size	D Tolerance
$\varnothing D \neq \varnothing d$	$\varnothing 3 \sim 16$	+0 ~ -0.01mm	$\varnothing D = \varnothing d$	$\varnothing 6 \sim 12$	-0.005 ~ -0.015mm
				$\varnothing 16$	-0.01 ~ -0.02mm

단위 : mm

Order Number	날경 Diameter D × R	날장 Length of cut L1	전장 Overall Length L	생크 Shank Dia d	비고	Order Number	날경 Diameter D × R	날장 Length of cut L1	전장 Overall Length L	생크 Shank Dia d	비고
6JJCR 030 001 060	3 X R0.1	7.5	60	6							
6JJCR 030 002 060	3 X R0.2	7.5	60	6							
6JJCR 030 003 060	3 X R0.3	7.5	60	6							
6JJCR 030 005 060	3 X R0.5	7.5	60	6							
6JJCR 030 010 060	3 X R1	7.5	60	6							
6JJCR 040 001 060	4 X R0.1	10	60	6							
6JJCR 040 002 060	4 X R0.2	10	60	6							
6JJCR 040 003 060	4 X R0.3	10	60	6							
6JJCR 040 005 060	4 X R0.5	10	60	6							
6JJCR 040 010 060	4 X R1	10	60	6							
6JJCR 050 002 060	5 X R0.2	13	60	6							
6JJCR 050 003 060	5 X R0.3	13	60	6							
6JJCR 050 005 060	5 X R0.5	13	60	6							
6JJCR 050 010 060	5 X R1	13	60	6							
6JJCR 060 001 060	6 X R0.1	15	60	6							
6JJCR 060 002 060	6 X R0.2	15	60	6							
6JJCR 060 002 080	6 X R0.2	15	80	6							
6JJCR 060 003 060	6 X R0.3	15	60	6							
6JJCR 060 003 080	6 X R0.3	15	80	6							
6JJCR 060 005 060	6 X R0.5	15	60	6							
6JJCR 060 005 080	6 X R0.5	15	80	6							
6JJCR 060 010 060	6 X R1	15	60	6							
6JJCR 060 010 080	6 X R1	15	80	6							
6JJCR 080 002 070	8 X R0.2	20	70	8							
6JJCR 080 003 070	8 X R0.3	20	70	8							
6JJCR 080 003 090	8 X R0.3	20	90	8							
6JJCR 080 005 070	8 X R0.5	20	70	8							
6JJCR 080 005 090	8 X R0.5	20	90	8							
6JJCR 080 010 070	8 X R1	20	70	8							
6JJCR 080 010 090	8 X R1	20	90	8							
6JJCR 080 015 070	8 X R1.5	20	70	8							
6JJCR 100 002 075	10 X R0.2	25	75	10							
6JJCR 100 003 075	10 X R0.3	25	75	10							
6JJCR 100 003 100	10 X R0.3	25	100	10							
6JJCR 100 005 075	10 X R0.5	25	75	10							
6JJCR 100 005 100	10 X R0.5	25	100	10							
6JJCR 100 010 075	10 X R1	25	75	10							
6JJCR 100 010 100	10 X R1	25	100	10							
6JJCR 100 020 075	10 X R2	25	75	10							
6JJCR 120 002 080	12 X R0.2	30	80	12							
6JJCR 120 003 080	12 X R0.3	30	80	12							
6JJCR 120 003 110	12 X R0.3	30	110	12							
6JJCR 120 005 080	12 X R0.5	30	80	12							
6JJCR 120 005 110	12 X R0.5	30	110	12							
6JJCR 120 010 080	12 X R1	30	80	12							
6JJCR 120 010 110	12 X R1	30	110	12							
6JJCR 120 020 080	12 X R2	30	80	12							
6JJCR 160 005 110	16 X R0.5	50	110	16							
6JJCR 160 010 110	16 X R1	50	110	16							
6JJCR 160 020 110	16 X R2	50	110	16							

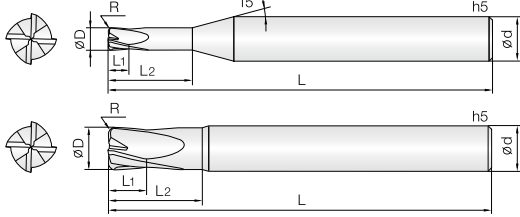

- 고경도강(HRc52~68), 프리하든강 계열의 고정밀 가공 엔드밀
- 고품량 실리콘계 코팅(Si) 처리하여 내마모성이 우수합니다.
- 저속 RPM에서 고이송 작업이 가능하도록 설계하였습니다..
- 종삭 및 황삭 가공시 작업 효율이 극대화 됩니다.
- 항절력이 높은 초미립자 초경합금을 채택하여, 고이송 작업시 엔드밀의 파손을 최소화 하였습니다.

#### • Endmills for pre-hardened and hardened steels(HRc52~68)

- Good wear resistance by high quality Si-based PVD coating.
- High precise edge tolerance.
- Designed for low speed with high feed condition.
- Suitable for heavy duty and roughing application.
- Minimize fracturing at high feed by high TRS ultra fine WC grade.

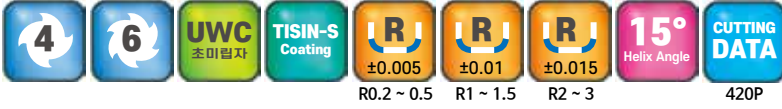

Condition	D Size	D Tolerance
øD ≠ ød	ø1 ~ 16	+0 ~ -0.01mm

Condition	D Size	D Tolerance
øD = ød	ø6 ~ 12	-0.005 ~ -0.015mm
	ø16	-0.01 ~ -0.02mm

단위 : mm

Order Number	날경 D × R	날장 Length of cut L1	유효장 Effective Length L2	전장 Overall Length L	샤프크 Shank Dia d	비고
4JJRC 010 002 025	1 X R0.2	1	2.5	50	4	
4JJRC 015 005 040	1.5 X R0.5	1.5	4	50	4	
4JJRC 020 005 060	2 X R0.5	2	6	50	6	
4JJRC 030 005 080	3 X R0.5	3	8	50	6	
4JJRC 040 005 120	4 X R0.5	4	12	60	6	
4JJRC 040 005 160	4 X R0.5	4	16	60	6	
4JJRC 040 010 120	4 X R1	4	12	60	6	
4JJRC 040 010 160	4 X R1	4	16	60	6	
4JJRC 050 005 150	5 X R0.5	5	15	60	6	
4JJRC 050 010 150	5 X R1	5	15	60	6	
4JJRC 060 003 150	6 X R0.3	6	15	60	6	
4JJRC 060 005 150	6 X R0.5	6	15	60	6	
4JJRC 060 010 150	6 X R1	6	15	60	6	
4JJRC 060 015 150	6 X R1.5	6	15	60	6	
4JJRC 080 003 160	8 X R0.3	8	16	60	8	
4JJRC 080 005 160	8 X R0.5	8	16	60	8	
4JJRC 080 005 200	8 X R0.5	8	20	80	8	
4JJRC 080 005 300	8 X R0.5	8	30	110	8	
4JJRC 080 010 160	8 X R1	8	16	60	8	
4JJRC 080 010 200	8 X R1	8	20	80	8	
4JJRC 080 010 300	8 X R1	8	30	110	8	
4JJRC 080 020 160	8 X R2	8	16	60	8	
4JJRC 080 020 200	8 X R2	8	20	80	8	
4JJRC 080 020 300	8 X R2	8	30	110	8	
4JJRC 100 003 200	10 X R0.3	10	20	70	10	
4JJRC 100 005 200	10 X R0.5	10	20	70	10	
4JJRC 100 005 250	10 X R0.5	10	25	90	10	
4JJRC 100 005 300	10 X R0.5	10	30	120	10	
4JJRC 100 010 200	10 X R1	10	20	70	10	
4JJRC 100 010 250	10 X R1	10	25	90	10	
4JJRC 100 010 300	10 X R1	10	30	120	10	
4JJRC 100 020 200	10 X R2	10	20	70	10	
4JJRC 100 020 250	10 X R2	10	25	90	10	
4JJRC 100 020 300	10 X R2	10	30	120	10	
4JJRC 120 005 250	12 X R0.5	12	25	80	12	
4JJRC 120 005 300	12 X R0.5	12	30	100	12	
4JJRC 120 005 350	12 X R0.5	12	35	130	12	
4JJRC 120 010 250	12 X R1	12	25	80	12	
4JJRC 120 010 300	12 X R1	12	30	100	12	
4JJRC 120 010 350	12 X R1	12	35	130	12	
4JJRC 120 020 250	12 X R2	12	25	80	12	
4JJRC 120 020 300	12 X R2	12	30	100	12	
4JJRC 120 020 350	12 X R2	12	35	130	12	
4JJRC 120 030 250	12 X R3	12	25	80	12	
4JJRC 160 010 300	16 X R1	16	30	110	16	
4JJRC 160 010 400	16 X R1	16	40	160	16	
4JJRC 160 020 300	16 X R2	16	30	110	16	
4JJRC 160 020 400	16 X R2	16	40	160	16	

Order Number	날경 D × R	날장 Length of cut L1	전장 Overall Length L	샤프크 Shank Dia d	비고
6JJRC 060 005 060	6 X R0.5	12	60	6	
6JJRC 060 010 060	6 X R1	12	60	6	
6JJRC 080 005 060	8 X R0.5	16	60	8	
6JJRC 080 010 060	8 X R1	16	60	8	
6JJRC 080 020 060	8 X R2	16	60	8	
6JJRC 100 005 070	10 X R0.5	20	70	10	
6JJRC 100 010 070	10 X R1	20	70	10	
6JJRC 100 020 070	10 X R2	20	70	10	
6JJRC 120 005 080	12 X R0.5	25	80	12	
6JJRC 120 010 080	12 X R1	25	80	12	
6JJRC 120 020 080	12 X R2	25	80	12	
6JJRC 160 005 100	16 X R0.5	30	100	16	
6JJRC 160 005 160	16 X R0.5	30	160	16	
6JJRC 160 010 100	16 X R1	30	100	16	
6JJRC 160 010 160	16 X R1	30	160	16	





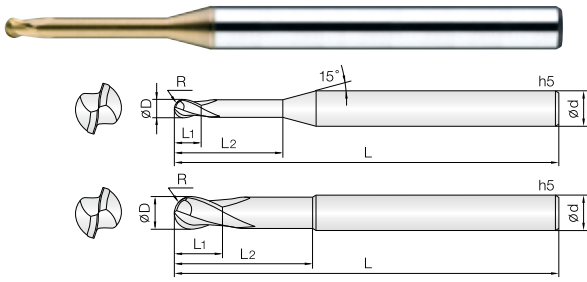

- 고경도강(HRC52~62), 프리하든강 계열의 고정밀 가공엔드밀
- 실리콘계 코팅(Si) 처리하여 내마모성이 우수합니다.
- 고정밀 공차 적용으로 초정밀 가공에 적합합니다.
- 날부인선의 조도가 뛰어난피삭재의 면조도가 우수합니다.
- 초미립자 초경합금(0.2 $\mu$ m)을채택, 고속절삭시 뛰어난 성능을 발휘합니다.

#### • Endmills for pre-hardened and hardened steel (HRC52~62)

- Good wear resistance by Si-based PVD coating.
- High precise edge tolerance.
- Very nice work surface finish.
- Outstanding performance at high speed machining by ultra fine (0.2 $\mu$ m) WC grade.

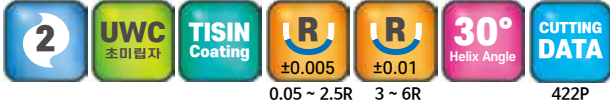

0.05 ~ 2.5R 3 ~ 6R 422P

Condition	D Size	D Tolerance	Condition	D Size	D Tolerance
ØD ≠ Ød	Ø0.1 ~ 0.15	+0 ~ -0.005mm	ØD = Ød	Ø6 ~ 12	-0.005 ~ -0.015mm
	Ø0.2 ~ 12	+0 ~ -0.01mm			

단위 : mm

Order Number	날경 Diameter R × D	날장 Length of cut L1	유효장 Effective Length L2	전장 Overall Length L	샙크 Shank Dia d	비고	Order Number	날경 Diameter R × D	날장 Length of cut L1	유효장 Effective Length L2	전장 Overall Length L	샙크 Shank Dia d	비고
2HRB 001 003 S04	0.05R X 0.1	0.15	0.3	40	4		2HRB 005 140 S04	0.25R X 0.5	0.5	14	45	4	
2HRB 001 005 S04	0.05R X 0.1	0.15	0.5	40	4		2HRB 006 010 S04	0.3R X 0.6	0.6	1	45	4	
2HRB 0015 003 S04	0.075R X 0.15	0.15	0.3	40	4		2HRB 006 020 S04	0.3R X 0.6	0.6	2	45	4	
2HRB 0015 005 S04	0.075R X 0.15	0.15	0.5	40	4		2HRB 006 030 S04	0.3R X 0.6	0.6	3	45	4	
2HRB 0015 010 S04	0.075R X 0.15	0.15	1	40	4		2HRB 006 040 S04	0.3R X 0.6	0.6	4	45	4	
2HRB 002 005 S04	0.1R X 0.2	0.2	0.5	40	4		2HRB 006 050 S04	0.3R X 0.6	0.6	5	45	4	
2HRB 002 010 S04	0.1R X 0.2	0.2	1	40	4		2HRB 006 060 S04	0.3R X 0.6	0.6	6	45	4	
2HRB 002 015 S04	0.1R X 0.2	0.2	1.5	40	4		2HRB 006 080 S04	0.3R X 0.6	0.6	8	45	4	
2HRB 002 020 S04	0.1R X 0.2	0.2	2	40	4		2HRB 006 100 S04	0.3R X 0.6	0.6	10	45	4	
2HRB 002 025 S04	0.1R X 0.2	0.2	2.5	40	4		2HRB 006 120 S04	0.3R X 0.6	0.6	12	45	4	
2HRB 002 030 S04	0.1R X 0.2	0.2	3	40	4		2HRB 006 140 S04	0.3R X 0.6	0.6	14	45	4	
2HRB 0025 005 S04	0.125R X 0.25	0.25	0.5	40	4		2HRB 006 160 S04	0.3R X 0.6	0.6	16	45	4	
2HRB 0025 010 S04	0.125R X 0.25	0.25	1	40	4		2HRB 007 020 S04	0.35R X 0.7	0.7	2	45	4	
2HRB 0025 015 S04	0.125R X 0.25	0.25	1.5	40	4		2HRB 007 040 S04	0.35R X 0.7	0.7	4	45	4	
2HRB 0025 020 S04	0.125R X 0.25	0.25	2	40	4		2HRB 007 060 S04	0.35R X 0.7	0.7	6	45	4	
2HRB 0025 025 S04	0.125R X 0.25	0.25	2.5	40	4		2HRB 007 080 S04	0.35R X 0.7	0.7	8	45	4	
2HRB 0025 030 S04	0.125R X 0.25	0.25	3	40	4		2HRB 007 100 S04	0.35R X 0.7	0.7	10	45	4	
2HRB 003 010 S04	0.15R X 0.3	0.3	1	40	4		2HRB 007 120 S04	0.35R X 0.7	0.7	12	45	4	
2HRB 003 015 S04	0.15R X 0.3	0.3	1.5	40	4		2HRB 008 020 S04	0.4R X 0.8	0.8	2	45	4	
2HRB 003 020 S04	0.15R X 0.3	0.3	2	40	4		2HRB 008 030 S04	0.4R X 0.8	0.8	3	45	4	
2HRB 003 025 S04	0.15R X 0.3	0.3	2.5	40	4		2HRB 008 040 S04	0.4R X 0.8	0.8	4	45	4	
2HRB 003 030 S04	0.15R X 0.3	0.3	3	40	4		2HRB 008 050 S04	0.4R X 0.8	0.8	5	45	4	
2HRB 003 035 S04	0.15R X 0.3	0.3	3.5	40	4		2HRB 008 060 S04	0.4R X 0.8	0.8	6	45	4	
2HRB 003 040 S04	0.15R X 0.3	0.3	4	40	4		2HRB 008 080 S04	0.4R X 0.8	0.8	8	45	4	
2HRB 003 050 S04	0.15R X 0.3	0.3	5	40	4		2HRB 008 100 S04	0.4R X 0.8	0.8	10	45	4	
2HRB 004 010 S04	0.2R X 0.4	0.4	1	40	4		2HRB 008 120 S04	0.4R X 0.8	0.8	12	45	4	
2HRB 004 015 S04	0.2R X 0.4	0.4	1.5	40	4		2HRB 008 140 S04	0.4R X 0.8	0.8	14	45	4	
2HRB 004 020 S04	0.2R X 0.4	0.4	2	40	4		2HRB 008 160 S04	0.4R X 0.8	0.8	16	45	4	
2HRB 004 025 S04	0.2R X 0.4	0.4	2.5	40	4		2HRB 009 040 S04	0.45R X 0.9	0.9	4	45	4	
2HRB 004 030 S04	0.2R X 0.4	0.4	3	40	4		2HRB 010 020 S04	0.5R X 1	1	2	45	4	
2HRB 004 035 S04	0.2R X 0.4	0.4	3.5	40	4		2HRB 010 020 S06	0.5R X 1	1	2	50	6	
2HRB 004 040 S04	0.2R X 0.4	0.4	4	40	4		2HRB 010 030 S04	0.5R X 1	1	3	45	4	
2HRB 004 045 S04	0.2R X 0.4	0.4	4.5	40	4		2HRB 010 030 S06	0.5R X 1	1	3	50	6	
2HRB 004 050 S04	0.2R X 0.4	0.4	5	40	4		2HRB 010 040 S04	0.5R X 1	1	4	45	4	
2HRB 004 060 S04	0.2R X 0.4	0.4	6	40	4		2HRB 010 040 S06	0.5R X 1	1	4	50	6	
2HRB 004 080 S04	0.2R X 0.4	0.4	8	40	4		2HRB 010 050 S04	0.5R X 1	1	5	45	4	
2HRB 004 100 S04	0.2R X 0.4	0.4	10	40	4		2HRB 010 050 S06	0.5R X 1	1	5	50	6	
2HRB 005 010 S04	0.25R X 0.5	0.5	1	45	4		2HRB 010 060 S04	0.5R X 1	1	6	45	4	
2HRB 005 015 S04	0.25R X 0.5	0.5	1.5	45	4		2HRB 010 060 S06	0.5R X 1	1	6	50	6	
2HRB 005 020 S04	0.25R X 0.5	0.5	2	45	4		2HRB 010 080 S04	0.5R X 1	1	8	45	4	
2HRB 005 025 S04	0.25R X 0.5	0.5	2.5	45	4		2HRB 010 080 S06	0.5R X 1	1	8	50	6	
2HRB 005 030 S04	0.25R X 0.5	0.5	3	45	4		2HRB 010 100 S04	0.5R X 1	1	10	50	4	
2HRB 005 035 S04	0.25R X 0.5	0.5	3.5	45	4		2HRB 010 100 S06	0.5R X 1	1	10	50	6	
2HRB 005 040 S04	0.25R X 0.5	0.5	4	45	4		2HRB 010 120 S04	0.5R X 1	1	12	50	4	
2HRB 005 045 S04	0.25R X 0.5	0.5	4.5	45	4		2HRB 010 120 S06	0.5R X 1	1	12	50	6	
2HRB 005 050 S04	0.25R X 0.5	0.5	5	45	4		2HRB 010 140 S04	0.5R X 1	1	14	50	4	
2HRB 005 060 S04	0.25R X 0.5	0.5	6	45	4		2HRB 010 140 S06	0.5R X 1	1	14	50	6	
2HRB 005 080 S04	0.25R X 0.5	0.5	8	45	4		2HRB 010 160 S04	0.5R X 1	1	16	50	4	
2HRB 005 100 S04	0.25R X 0.5	0.5	10	45	4		2HRB 010 160 S06	0.5R X 1	1	16	60	6	
2HRB 005 120 S04	0.25R X 0.5	0.5	12	45	4		2HRB 010 180 S04	0.5R X 1	1	18	50	4	

단위 : mm

Order Number	날경 Diameter R × D	날장 Length of cut L1	유효장 Effective Length L2	전장 Overall Length L	샙크 Shank Dia d	비고	Order Number	날경 Diameter R × D	날장 Length of cut L1	유효장 Effective Length L2	전장 Overall Length L	샙크 Shank Dia d	비고
2HRB 010 180 S06	0.5R X 1	1	18	60	6		2HRB 015 250 S06	0.75R X 1.5	1.5	25	65	6	
2HRB 010 200 S04	0.5R X 1	1	20	50	4		2HRB 015 300 S04	0.75R X 1.5	1.5	30	70	4	
2HRB 010 200 S06	0.5R X 1	1	20	60	6		2HRB 015 300 S06	0.75R X 1.5	1.5	30	70	6	
2HRB 010 220 S04	0.5R X 1	1	22	60	4		2HRB 015 350 S04	0.75R X 1.5	1.5	35	70	4	
2HRB 010 220 S06	0.5R X 1	1	22	65	6		2HRB 015 400 S04	0.75R X 1.5	1.5	40	80	4	
2HRB 010 250 S04	0.5R X 1	1	25	60	4		2HRB 016 060 S04	0.8R X 1.6	1.6	6	45	4	
2HRB 010 300 S04	0.5R X 1	1	30	70	4		2HRB 016 080 S04	0.8R X 1.6	1.6	8	45	4	
2HRB 012 040 S04	0.6R X 1.2	1.2	4	45	4		2HRB 016 120 S04	0.8R X 1.6	1.6	12	50	4	
2HRB 012 040 S06	0.6R X 1.2	1.2	4	50	6		2HRB 016 160 S04	0.8R X 1.6	1.6	16	50	4	
2HRB 012 060 S04	0.6R X 1.2	1.2	6	45	4		2HRB 016 200 S04	0.8R X 1.6	1.6	20	50	4	
2HRB 012 060 S06	0.6R X 1.2	1.2	6	50	6		2HRB 018 060 S04	0.9R X 1.8	1.8	6	45	4	
2HRB 012 080 S04	0.6R X 1.2	1.2	8	45	4		2HRB 018 080 S04	0.9R X 1.8	1.8	8	45	4	
2HRB 012 080 S06	0.6R X 1.2	1.2	8	50	6		2HRB 018 120 S04	0.9R X 1.8	1.8	12	50	4	
2HRB 012 100 S04	0.6R X 1.2	1.2	10	50	4		2HRB 018 160 S04	0.9R X 1.8	1.8	16	50	4	
2HRB 012 100 S06	0.6R X 1.2	1.2	10	50	6		2HRB 018 200 S04	0.9R X 1.8	1.8	20	50	4	
2HRB 012 120 S04	0.6R X 1.2	1.2	12	50	4		2HRB 020 040 S04	1R X 2	2	4	45	4	
2HRB 012 120 S06	0.6R X 1.2	1.2	12	50	6		2HRB 020 040 S06	1R X 2	2	4	50	6	
2HRB 012 160 S04	0.6R X 1.2	1.2	16	50	4		2HRB 020 060 S04	1R X 2	2	6	45	4	
2HRB 012 160 S06	0.6R X 1.2	1.2	16	60	6		2HRB 020 060 S06	1R X 2	2	6	50	6	
2HRB 012 200 S04	0.6R X 1.2	1.2	20	50	4		2HRB 020 080 S04	1R X 2	2	8	45	4	
2HRB 012 200 S06	0.6R X 1.2	1.2	20	60	6		2HRB 020 080 S06	1R X 2	2	8	50	6	
2HRB 012 240 S04	0.6R X 1.2	1.2	24	60	4		2HRB 020 100 S04	1R X 2	2	10	50	4	
2HRB 012 240 S06	0.6R X 1.2	1.2	24	65	6		2HRB 020 100 S06	1R X 2	2	10	50	6	
2HRB 014 060 S04	0.7R X 1.4	1.4	6	45	4		2HRB 020 120 S04	1R X 2	2	12	50	4	
2HRB 014 080 S04	0.7R X 1.4	1.4	8	45	4		2HRB 020 120 S06	1R X 2	2	12	50	6	
2HRB 014 120 S04	0.7R X 1.4	1.4	12	50	4		2HRB 020 140 S04	1R X 2	2	14	50	4	
2HRB 014 160 S04	0.7R X 1.4	1.4	16	50	4		2HRB 020 140 S06	1R X 2	2	14	50	6	
2HRB 015 030 S04	0.75R X 1.5	1.5	3	45	4		2HRB 020 160 S04	1R X 2	2	16	50	4	
2HRB 015 030 S06	0.75R X 1.5	1.5	3	50	6		2HRB 020 160 S06	1R X 2	2	16	60	6	
2HRB 015 040 S04	0.75R X 1.5	1.5	4	45	4		2HRB 020 180 S04	1R X 2	2	18	50	4	
2HRB 015 040 S06	0.75R X 1.5	1.5	4	50	6		2HRB 020 180 S06	1R X 2	2	18	60	6	
2HRB 015 060 S04	0.75R X 1.5	1.5	6	45	4		2HRB 020 200 S04	1R X 2	2	20	50	4	
2HRB 015 060 S06	0.75R X 1.5	1.5	6	50	6		2HRB 020 200 S06	1R X 2	2	20	60	6	
2HRB 015 080 S04	0.75R X 1.5	1.5	8	45	4		2HRB 020 220 S04	1R X 2	2	22	60	4	
2HRB 015 080 S06	0.75R X 1.5	1.5	8	50	6		2HRB 020 220 S06	1R X 2	2	22	65	6	
2HRB 015 100 S04	0.75R X 1.5	1.5	10	50	4		2HRB 020 250 S04	1R X 2	2	25	60	4	
2HRB 015 100 S06	0.75R X 1.5	1.5	10	50	6		2HRB 020 250 S06	1R X 2	2	25	65	6	
2HRB 015 120 S04	0.75R X 1.5	1.5	12	50	4		2HRB 020 300 S04	1R X 2	2	30	70	4	
2HRB 015 120 S06	0.75R X 1.5	1.5	12	50	6		2HRB 020 300 S06	1R X 2	2	30	70	6	
2HRB 015 140 S04	0.75R X 1.5	1.5	14	50	4		2HRB 020 350 S04	1R X 2	2	35	70	4	
2HRB 015 140 S06	0.75R X 1.5	1.5	14	50	6		2HRB 020 350 S06	1R X 2	2	35	75	6	
2HRB 015 160 S04	0.75R X 1.5	1.5	16	50	4		2HRB 020 400 S04	1R X 2	2	40	80	4	
2HRB 015 160 S06	0.75R X 1.5	1.5	16	60	6		2HRB 020 400 S06	1R X 2	2	40	80	6	
2HRB 015 180 S04	0.75R X 1.5	1.5	18	50	4		2HRB 020 450 S04	1R X 2	2	45	80	4	
2HRB 015 180 S06	0.75R X 1.5	1.5	18	60	6		2HRB 020 500 S04	1R X 2	2	50	90	4	
2HRB 015 200 S04	0.75R X 1.5	1.5	20	50	4		2HRB 025 080 S04	1.25R X 2.5	2.5	8	45	4	
2HRB 015 200 S06	0.75R X 1.5	1.5	20	60	6		2HRB 025 080 S06	1.25R X 2.5	2.5	8	50	6	
2HRB 015 220 S04	0.75R X 1.5	1.5	22	60	4		2HRB 025 100 S04	1.25R X 2.5	2.5	10	50	4	
2HRB 015 220 S06	0.75R X 1.5	1.5	22	65	6		2HRB 025 100 S06	1.25R X 2.5	2.5	10	50	6	
2HRB 015 250 S04	0.75R X 1.5	1.5	25	60	4		2HRB 025 120 S04	1.25R X 2.5	2.5	12	50	4	





단위 : mm

Order Number	날경 Diameter R × D	날장 Length of cut L1	유효장 Effective Length L2	전장 Overall Length L	생크 Shank Dia d	비고	Order Number	날경 Diameter R × D	날장 Length of cut L1	유효장 Effective Length L2	전장 Overall Length L	생크 Shank Dia d	비고
2HRB 025 120 S06	1.25R X 2.5	2.5	12	50	6		2HRB 080 250 060	4R X 8	12	25	60	8	
2HRB 025 160 S04	1.25R X 2.5	2.5	16	50	4		2HRB 080 300 100	4R X 8	12	30	100	8	
2HRB 025 160 S06	1.25R X 2.5	2.5	16	60	6		2HRB 100 300 070	5R X 10	16	30	70	10	
2HRB 025 200 S04	1.25R X 2.5	2.5	20	60	4		2HRB 100 350 100	5R X 10	16	35	100	10	
2HRB 025 250 S04	1.25R X 2.5	2.5	25	60	4		2HRB 120 300 075	6R X 12	18	30	75	12	
2HRB 025 300 S04	1.25R X 2.5	2.5	30	70	4		2HRB 120 400 110	6R X 12	18	40	110	12	
2HRB 025 350 S04	1.25R X 2.5	2.5	35	70	4								
2HRB 025 400 S04	1.25R X 2.5	2.5	40	80	4								
2HRB 030 060 S06	1.5R X 3	3	6	50	6								
2HRB 030 080 S06	1.5R X 3	3	8	50	6								
2HRB 030 100 S06	1.5R X 3	3	10	50	6								
2HRB 030 120 S06	1.5R X 3	3	12	50	6								
2HRB 030 160 S06	1.5R X 3	3	16	60	6								
2HRB 030 200 S06	1.5R X 3	3	20	60	6								
2HRB 030 250 S06	1.5R X 3	3	25	65	6								
2HRB 030 300 S06	1.5R X 3	3	30	70	6								
2HRB 030 350 S06	1.5R X 3	3	35	75	6								
2HRB 030 400 S06	1.5R X 3	3	40	80	6								
2HRB 030 450 S06	1.5R X 3	3	45	90	6								
2HRB 030 500 S06	1.5R X 3	3	50	100	6								
2HRB 030 600 S06	1.5R X 3	3	60	100	6								
2HRB 030 650 S06	1.5R X 3	3	65	110	6								
2HRB 030 700 S06	1.5R X 3	3	70	110	6								
2HRB 040 080 S06	2R X 4	4	8	50	6								
2HRB 040 100 S06	2R X 4	4	10	50	6								
2HRB 040 120 S06	2R X 4	4	12	50	6								
2HRB 040 160 S06	2R X 4	4	16	60	6								
2HRB 040 200 S06	2R X 4	4	20	60	6								
2HRB 040 250 S06	2R X 4	4	25	65	6								
2HRB 040 300 S06	2R X 4	4	30	70	6								
2HRB 040 350 S06	2R X 4	4	35	75	6								
2HRB 040 400 S06	2R X 4	4	40	80	6								
2HRB 040 450 S06	2R X 4	4	45	90	6								
2HRB 040 500 S06	2R X 4	4	50	100	6								
2HRB 040 550 S06	2R X 4	4	55	100	6								
2HRB 040 600 S06	2R X 4	4	60	100	6								
2HRB 040 650 S06	2R X 4	4	65	110	6								
2HRB 040 700 S06	2R X 4	4	70	110	6								
2HRB 050 160 S06	2.5R X 5	6	16	60	6								
2HRB 050 200 S06	2.5R X 5	6	20	60	6								
2HRB 050 250 S06	2.5R X 5	6	25	70	6								
2HRB 050 300 S06	2.5R X 5	6	30	75	6								
2HRB 050 400 S06	2.5R X 5	6	40	80	6								
2HRB 050 450 S06	2.5R X 5	6	45	90	6								
2HRB 050 500 S06	2.5R X 5	6	50	100	6								
2HRB 050 600 S06	2.5R X 5	6	60	100	6								
2HRB 050 650 S06	2.5R X 5	6	65	110	6								
2HRB 050 700 S06	2.5R X 5	6	70	110	6								
2HRB 060 150 S06	3R X 6	10	15	55	6								
2HRB 060 300 S06	3R X 6	10	30	110	6								

# 2PHCB 2 Flutes Ultra Precision Standard Length Ball End Mills

## 2날 초정밀 표준 길이 볼 엔드밀

HARD series

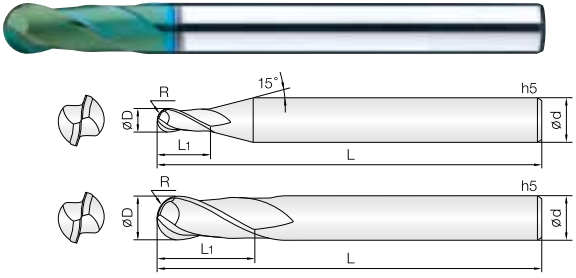

- 고경도강(HRc52~62), 프리하든강 계열의 고정밀( $\pm 2\mu\text{m}$ )가공용
- 실리콘계 코팅(Si) 처리하여 내마모성이 우수합니다.
- 초정밀 공차 적용으로 초정밀 가공에 적합합니다.
- 날부인선의 조도가 뛰어나 피삭재의 면조도가 우수합니다.
- 초미립자 초경합금(0.2 $\mu\text{m}$ )을 채택, 고속절삭시 뛰어난 성능을 발휘합니다.
- Endmills for pre-hardened and hardened steels(HRc52~62)
- Good wear resistance by Si-based PVD coating.
- Ultra high precise edge tolerance.
- Very nice work surface finish.
- Outstanding performance at high speed machining by ultra fine (0.2 $\mu\text{m}$ ) WC grade.

2
UWC 초미립자
TISIN-S Coating
R ±0.002
R ±0.003
R ±0.005
30° Helix Angle
CUTTING DATA

0.1 ~ 1R    1.25 ~ 2R    2.5 ~ 6R    423P

Condition	D Size	D Tolerance	Condition	D Size	D Tolerance
$\varnothing D \neq \varnothing d$	$\varnothing 0.2 \sim 12$	$+0 \sim -0.01\text{mm}$	$\varnothing D = \varnothing d$	$\varnothing 4 \sim 12$	$-0.005 \sim -0.015\text{mm}$

단위 : mm

Order Number	날경 Diameter R x D	날장 Length of cut L1	전장 Overall Length L	생크 Shank Dia d	비고	Order Number	날경 Diameter R x D	날장 Length of cut L1	전장 Overall Length L	생크 Shank Dia d	비고
2PHCB 002 004 S04	0.1R X 0.2	0.4	40	4							
2PHCB 003 006 S04	0.15R X 0.3	0.6	40	4							
2PHCB 004 008 S04	0.2R X 0.4	0.8	40	4							
2PHCB 005 010 S04	0.25R X 0.5	1	45	4							
2PHCB 006 012 S04	0.3R X 0.6	1.2	45	4							
2PHCB 007 015 S04	0.35R X 0.7	1.5	45	4							
2PHCB 008 020 S04	0.4R X 0.8	2	45	4							
2PHCB 009 020 S04	0.45R X 0.9	2	45	4							
2PHCB 010 025 S04	0.5R X 1	2.5	50	4							
2PHCB 010 025 S06	0.5R X 1	2.5	50	6							
2PHCB 012 030 S04	0.6R X 1.2	3	50	4							
2PHCB 015 040 S04	0.75R X 1.5	4	50	4							
2PHCB 015 040 S06	0.75R X 1.5	4	50	6							
2PHCB 020 050 S04	1R X 2	5	50	4							
2PHCB 020 050 S06	1R X 2	5	50	6							
2PHCB 025 060 S04	1.25R X 2.5	6	50	4							
2PHCB 030 080 S04	1.5R X 3	8	50	4							
2PHCB 030 080 S06	1.5R X 3	8	60	6							
2PHCB 035 080 S06	1.75R X 3.5	8	60	6							
2PHCB 040 080 S04	2R X 4	8	60	4							
2PHCB 040 080 S06	2R X 4	8	70	6							
2PHCB 045 080 S06	2.25R X 4.5	8	70	6							
2PHCB 050 100 S06	2.5R X 5	10	75	6							
2PHCB 055 100 S06	2.75R X 5.5	10	75	6							
2PHCB 060 120 080	3R X 6	12	80	6							
2PHCB 070 140 S08	3.5R X 7	14	80	8							
2PHCB 080 140 090	4R X 8	14	90	8							
2PHCB 100 180 100	5R X 10	18	100	10							
2PHCB 120 220 110	6R X 12	22	110	12							

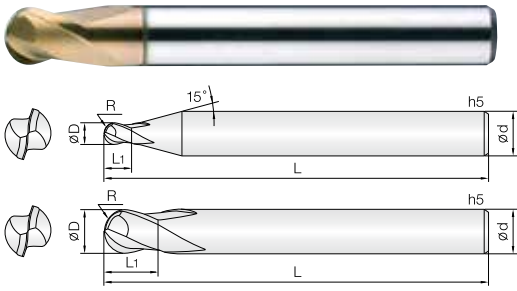

- 고경도강(HRc50~62), 프리하든강 계열의 고정밀 가공 엔드밀
- 실리콘계 코팅 (Si) 처리하여 내마모성이 우수합니다.
- 고정밀 공차 적용으로 초정밀 가공에 적합합니다.
- 짧은 전장을 채택하여, 열박음척 사용이 용이합니다.
- 날부인선의 조도가 뛰어나피삭재의 면조도가 우수합니다.
- 초미립자 초경합금 (0.2 $\mu$ m)을 채택, 고속절삭시 뛰어난 성능을 발휘합니다.

#### • Endmills for pre-hardened and hardened steels(HRc50~62)

- Good wear resistance by Si-based PVD coating.
- High precise edge tolerance.
- Short overall length for easy use with shrinking chuck.
- Very nice work surface finish.
- Outstanding performance at high speed machining by ultra fine (0.2 $\mu$ m) WC grade.

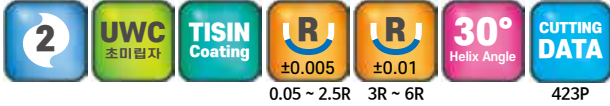

0.05 ~ 2.5R 3R ~ 6R

423P

Condition	D Size	D Tolerance	Condition	D Size	D Tolerance
$\varnothing D \neq \varnothing d$	$\varnothing 0.1 \sim 0.15$	+0 ~ -0.005mm	$\varnothing D = \varnothing d$	$\varnothing 4 \sim 12$	-0.005 ~ -0.015mm
	$\varnothing 0.2 \sim 12$	+0 ~ -0.01mm			

단위 : mm

Order Number	날경 Diameter R x D	날장 Length of cut L1	전장 Overall Length L	생크 Shank Dia d	비고	Order Number	날경 Diameter R x D	날장 Length of cut L1	전장 Overall Length L	생크 Shank Dia d	비고
2HSB 001 001 S04	0.05R X 0.1	0.1	40	4		2HSB 100 100 060	5R X 10	10	60	10	
2HSB 001 0015 S04	0.05R X 0.1	0.15	40	4		2HSB 100 100 070	5R X 10	10	70	10	
2HSB 0015 0015 S04	0.075R X 0.15	0.15	40	4		2HSB 120 120 060	6R X 12	12	60	12	
2HSB 0015 002 S04	0.075R X 0.15	0.2	40	4		2HSB 120 120 070	6R X 12	12	70	12	
2HSB 002 002 S04	0.1R X 0.2	0.2	40	4							
2HSB 002 003 S04	0.1R X 0.2	0.3	40	4							
2HSB 0025 004 S04	0.125R X 0.25	0.4	40	4							
2HSB 003 003 S04	0.15R X 0.3	0.3	40	4							
2HSB 003 0045 S04	0.15R X 0.3	0.45	40	4							
2HSB 004 004 S04	0.2R X 0.4	0.4	40	4							
2HSB 004 006 S04	0.2R X 0.4	0.6	40	4							
2HSB 005 005 S04	0.25R X 0.5	0.5	40	4							
2HSB 005 0075 S04	0.25R X 0.5	0.75	40	4							
2HSB 006 006 S04	0.3R X 0.6	0.6	40	4							
2HSB 006 009 S04	0.3R X 0.6	0.9	40	4							
2HSB 007 007 S04	0.35R X 0.7	0.7	40	4							
2HSB 007 010 S04	0.35R X 0.7	1	40	4							
2HSB 008 008 S04	0.4R X 0.8	0.8	40	4							
2HSB 008 012 S04	0.4R X 0.8	1.2	40	4							
2HSB 009 009 S04	0.45R X 0.9	0.9	40	4							
2HSB 009 013 S04	0.45R X 0.9	1.3	40	4							
2HSB 010 010 S04	0.5R X 1	1	40	4							
2HSB 010 010 S06	0.5R X 1	1	40	6							
2HSB 010 015 S04	0.5R X 1	1.5	40	4							
2HSB 010 015 S06	0.5R X 1	1.5	40	6							
2HSB 012 012 S04	0.6R X 1.2	1.2	40	4							
2HSB 015 015 S04	0.75R X 1.5	1.5	40	4							
2HSB 015 015 S06	0.75R X 1.5	1.5	40	6							
2HSB 015 023 S04	0.75R X 1.5	2.3	40	4							
2HSB 015 023 S06	0.75R X 1.5	2.3	40	6							
2HSB 020 020 S04	1R X 2	2	45	4							
2HSB 020 020 S06	1R X 2	2	45	6							
2HSB 020 030 S04	1R X 2	3	45	4							
2HSB 020 030 S06	1R X 2	3	45	6							
2HSB 025 025 S04	1.25R X 2.5	2.5	45	4							
2HSB 025 025 S06	1.25R X 2.5	2.5	45	6							
2HSB 030 030 S04	1.5R X 3	3	45	4							
2HSB 030 030 S06	1.5R X 3	3	45	6							
2HSB 030 045 S04	1.5R X 3	4.5	45	4							
2HSB 030 045 S06	1.5R X 3	4.5	45	6							
2HSB 040 040 S04	2R X 4	4	45	4							
2HSB 040 040 S06	2R X 4	4	45	6							
2HSB 040 060 S04	2R X 4	6	45	4							
2HSB 040 060 S06	2R X 4	6	45	6							
2HSB 050 050 S06	2.5R X 5	5	50	6							
2HSB 050 075 S06	2.5R X 5	7.5	50	6							
2HSB 060 060 050	3R X 6	6	50	6							
2HSB 060 060 060	3R X 6	6	60	6							
2HSB 080 080 050	4R X 8	8	50	8							
2HSB 080 080 060	4R X 8	8	60	8							

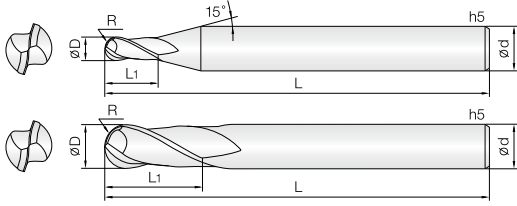

- 고경도강(HRc50~62), 프리하든강 계열의 고정밀 가공 엔드밀
  - 실리콘계 코팅(Si) 처리하여 내마모성이 우수합니다.
  - 고정밀 공차 적용으로 초정밀 가공에 적합합니다.
  - 날부인선의 조도가 뛰어나 피삭재의 면조도가 우수합니다.
  - 초미립자 초경합금(0.2μm)을 채택, 고속절삭시 뛰어난 성능을 발휘합니다.
- Endmills for pre-hardened and hardened steels(HRc50~62)
  - Good wear resistance by Si-based PVD coating.
  - High precise edge tolerance.
  - Very nice work surface finish.
  - Outstanding performance at high speed machining by ultra fine (0.2μm) WC grade.

2

UWC  
초미립자

TISIN  
Coating

R

R

R

30°

CUTTING  
DATA

0.03 ~ 2.9R
3 ~ 6R
6.5 ~ 10R
423P

Condition	D Size		D Tolerance	
	ØD ≠ Ød	Ø0.06 ~ 0.15	Ø3 ~ 12	+0 ~ -0.005mm
	Ø0.2 ~ 20	Ø14 ~ 20	+0 ~ -0.01mm	-0.01 ~ -0.02mm

단위 : mm

Order Number	날경 Diameter R × D	날장 Length of cut L1	전장 Overall Length L	샤크 Dia d	비고
2HCB 0006 001 S04	0.03R X 0.06	0.1	40	4	
2HCB 0007 0012 S04	0.035R X 0.07	0.12	40	4	
2HCB 0008 0015 S04	0.04R X 0.08	0.15	40	4	
2HCB 0009 0017 S04	0.045R X 0.09	0.17	40	4	
2HCB 001 002 S04	0.05R X 0.1	0.2	40	4	
2HCB 0015 003 S04	0.075R X 0.15	0.3	40	4	
2HCB 002 004 S04	0.1R X 0.2	0.4	40	4	
2HCB 003 006 S04	0.15R X 0.3	0.6	40	4	
2HCB 004 008 S04	0.2R X 0.4	0.8	40	4	
2HCB 005 010 S04	0.25R X 0.5	1	45	4	
2HCB 006 012 S04	0.3R X 0.6	1.2	45	4	
2HCB 007 015 S04	0.35R X 0.7	1.5	45	4	
2HCB 008 020 S04	0.4R X 0.8	2	45	4	
2HCB 009 020 S04	0.45R X 0.9	2	45	4	
2HCB 010 025 S03	0.5R X 1	2.5	50	3	
2HCB 010 025 S04	0.5R X 1	2.5	50	4	
2HCB 010 025 S06	0.5R X 1	2.5	50	6	
2HCB 010 025 070	0.5R X 1	2.5	70	6	
2HCB 010 025 100	0.5R X 1	2.5	100	6	
2HCB 011 027 S04	0.55R X 1.1	2.7	50	4	
2HCB 012 030 S03	0.6R X 1.2	3	50	3	
2HCB 012 030 S04	0.6R X 1.2	3	50	4	
2HCB 013 032 S04	0.65R X 1.3	3.2	50	4	
2HCB 014 035 S04	0.7R X 1.4	3.5	50	4	
2HCB 015 040 S03	0.75R X 1.5	4	50	3	
2HCB 015 040 S04	0.75R X 1.5	4	50	4	
2HCB 015 040 S06	0.75R X 1.5	4	50	6	
2HCB 015 040 070	0.75R X 1.5	4	70	6	
2HCB 015 040 100	0.75R X 1.5	4	100	6	
2HCB 016 040 S04	0.8R X 1.6	4	50	4	
2HCB 017 042 S04	0.85R X 1.7	4.2	50	4	
2HCB 018 045 S04	0.9R X 1.8	4.5	50	4	
2HCB 019 047 S04	0.95R X 1.9	4.7	50	4	
2HCB 020 050 S03	1R X 2	5	50	3	
2HCB 020 050 S04	1R X 2	5	50	4	
2HCB 020 050 S06	1R X 2	5	50	6	
2HCB 020 050 075	1R X 2	5	75	6	
2HCB 020 050 100	1R X 2	5	100	6	
2HCB 022 055 S04	1.1R X 2.2	5.5	50	4	
2HCB 024 060 S04	1.2R X 2.4	6	50	4	
2HCB 025 060 S03	1.25R X 2.5	6	50	3	
2HCB 025 060 S04	1.25R X 2.5	6	50	4	
2HCB 025 060 S06	1.25R X 2.5	6	75	6	
2HCB 025 060 100	1.25R X 2.5	6	100	6	
2HCB 026 060 S04	1.3R X 2.6	6	50	4	
2HCB 028 070 S04	1.4R X 2.8	7	50	4	
2HCB 030 080 S03	1.5R X 3	8	60	3	
2HCB 030 080 S04	1.5R X 3	8	50	4	
2HCB 030 080 S06	1.5R X 3	8	60	6	
2HCB 030 080 080	1.5R X 3	8	80	6	
2HCB 030 080 100	1.5R X 3	8	100	6	
2HCB 030 080 120	1.5R X 3	8	120	6	
2HCB 030 080 150	1.5R X 3	8	150	6	
2HCB 030 080 200	1.5R X 3	8	200	6	
2HCB 030 080 250	1.5R X 3	8	250	6	
2HCB 030 080 300	1.5R X 3	8	300	6	
2HCB 030 080 350	1.5R X 3	8	350	6	
2HCB 030 080 400	1.5R X 3	8	400	6	
2HCB 030 080 450	1.5R X 3	8	450	6	
2HCB 030 080 500	1.5R X 3	8	500	6	
2HCB 030 080 600	1.5R X 3	8	600	6	
2HCB 030 080 800	1.5R X 3	8	800	6	
2HCB 030 080 1000	1.5R X 3	8	1000	6	
2HCB 030 080 1200	1.5R X 3	8	1200	6	
2HCB 030 080 1500	1.5R X 3	8	1500	6	
2HCB 030 080 2000	1.5R X 3	8	2000	6	
2HCB 030 080 2500	1.5R X 3	8	2500	6	
2HCB 030 080 3000	1.5R X 3	8	3000	6	
2HCB 030 080 4000	1.5R X 3	8	4000	6	
2HCB 030 080 5000	1.5R X 3	8	5000	6	
2HCB 030 080 6000	1.5R X 3	8	6000	6	
2HCB 030 080 8000	1.5R X 3	8	8000	6	
2HCB 030 080 10000	1.5R X 3	8	10000	6	

# 3HCB

## 3 Flutes High Speed Standard Length Ball End Mills

### 3날 고속가공용 표준 길이 볼 엔드밀

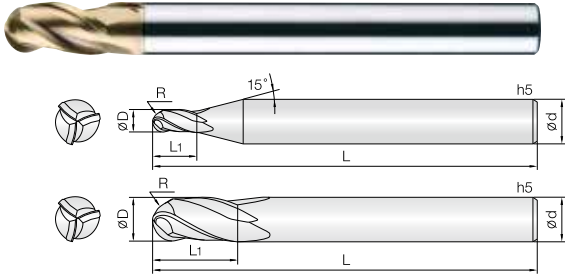

- 고경도강(HRc50~65), 프리하든강 계열의 고속 가공 엔드밀
- 실리콘계 코팅(Si) 처리하여 내마모성이 우수합니다.
- 고정밀 공차 적용으로 초정밀 가공에 적합합니다.
- 3날 볼타입 적용으로 고속·고이송 작업이 가능합니다.
- 항절삭력이 높은 미립자 초경합금(0.5µm)을 채택, 엔드밀의 파손을 최소화 하였습니다.

#### • Endmills for pre-hardened and hardened steels(HRc50~65)

- Good wear resistance by Si-based PVD coating.
- High precise edge tolerance.
- High speed, feed applicable by 3 flute ball edge.
- Minimize fracturing by high TRS fine(0.5µm) WC grade.

3 WC 미립자 TISIN Coating R ±0.005 R ±0.01 30° Helix Angle CUTTING DATA  
 0.5 ~ 2.5R 3R ~ 6R 424P

Condition	D Size	D Tolerance	Condition	D Size	D Tolerance
ØD ≠ Ød	Ø1 ~ 12	+0 ~ -0.01mm	ØD = Ød	Ø4 ~ 12	-0.005 ~ -0.015mm

단위 : mm

Order Number	날경 Diameter R × D	날장 Length of cut L1	전장 Overall Length L	샙크 Shank Dia d	비고
3HCB 010 025 S04	0.5R X 1	2.5	50	4	
3HCB 015 040 S04	0.75R X 1.5	4	50	4	
3HCB 020 050 S06	1R X 2	5	50	6	
3HCB 030 080 S06	1.5R X 3	8	65	6	
3HCB 040 080 S04	2R X 4	8	60	4	
3HCB 040 080 S06	2R X 4	8	70	6	
3HCB 050 100 S06	2.5R X 5	10	75	6	
3HCB 060 120 S06	3R X 6	12	80	6	

Order Number	날경 Diameter R × D	날장 Length of cut L1	전장 Overall Length L	샙크 Shank Dia d	비고
3HCB 060 120 120	3R X 6	12	120	6	
3HCB 080 140 S08	4R X 8	14	90	8	
3HCB 080 140 150	4R X 8	14	150	8	
3HCB 100 180 S10	5R X 10	18	100	10	
3HCB 100 180 150	5R X 10	18	150	10	
3HCB 120 220 S12	6R X 12	22	110	12	
3HCB 120 220 150	6R X 12	22	150	12	

# 4HSB

## 4 Flutes High Speed Short Length Ball End Mill

### 4날 고속가공용 짧은 길이 볼 엔드밀

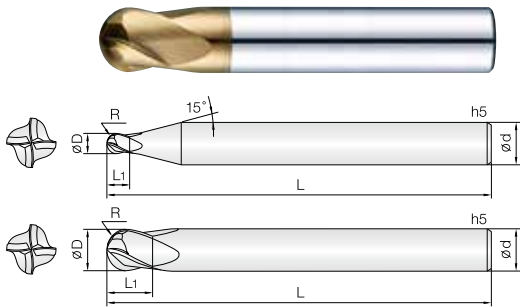

- 고경도강(HRc50~62), 프리하든강 계열의 고정밀 가공 엔드밀
- 실리콘계 코팅(Si) 처리하여 내마모성이 우수합니다.
- 고정밀 공차 적용으로 초정밀 가공에 적합합니다.
- 짧은 전장을 채택하여, 열박음척 사용이 용이합니다.
- 4날 볼타입 적용으로 고속·고이송 작업이 가능합니다.
- 초미립자 초경합금(0.2µm)을 채택, 고속절삭시 뛰어난 성능을 발휘합니다.

#### • Endmills for pre-hardened and hardened steel(HRc50~62)

- Good wear resistance by Si-based PVD coating.
- High precise edge tolerance.
- Short overall length for easy use with shrinking chuck.
- High speed, feed applicable by 3 flute ball edge.
- Outstanding performance at high speed machining by ultra fine. (0.2µm) WC grade.

4 UWC 초미립자 TISIN Coating R ±0.005 R ±0.01 30° Helix Angle CUTTING DATA  
 0.5 ~ 2.5R 3R ~ 6R 424P

Condition	D Size	D Tolerance	Condition	D Size	D Tolerance
ØD ≠ Ød	Ø1 ~ 12	+0 ~ -0.01mm	ØD = Ød	Ø4 ~ 12	-0.005 ~ -0.015mm

단위 : mm

Order Number	날경 Diameter R × D	날장 Length of cut L1	전장 Overall Length L	샙크 Shank Dia d	비고
4HSB 010 012 S04	0.5R X 1	1.2	40	4	
4HSB 012 015 S04	0.6R X 1.2	1.5	40	4	
4HSB 015 018 S04	0.75R X 1.5	1.8	40	4	
4HSB 020 024 S04	1R X 2	2.4	40	4	
4HSB 025 030 S04	1.25R X 2.5	3	45	4	
4HSB 030 036 S06	1.5R X 3	3.6	45	6	
4HSB 040 050 S04	2R X 4	5	45	4	
4HSB 040 050 S06	2R X 4	5	45	6	
4HSB 050 060 S06	2.5R X 5	6	50	6	
4HSB 060 070 S06	3R X 6	7	50	6	
4HSB 060 070 060	3R X 6	7	60	6	
4HSB 080 080 S08	4R X 8	8	60	8	
4HSB 100 100 S10	5R X 10	10	60	10	
4HSB 120 120 S12	6R X 12	12	75	12	

Order Number	날경 Diameter R × D	날장 Length of cut L1	전장 Overall Length L	샙크 Shank Dia d	비고

### 4날 고속가공용 표준 길이 볼 엔드밀

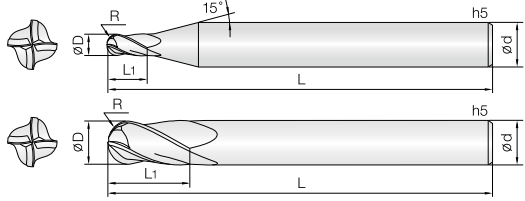

- 고경도강(HRc50~65), 프리하드강 계열의 고속 가공 엔드밀
- 실리콘계 코팅(Si) 처리하여 내마모성이 우수합니다.
- 고정밀 공차 적용으로 초정밀 가공에 적합합니다.
- 4날 볼타입 적용으로 고속 · 고이송 작업이 가능합니다.
- 항절력이 높은 미립자 초경합금(0.5μm)을 채택, 엔드밀의 파손을 최소화 하였습니다.

#### • Endmills for pre-hardened and hardened steels(HRc50~65)

- Good wear resistance by Si-based PVD coating.
- High precise edge tolerance.
- High speed, feed applicable by 4 flute ball edge.
- Minimize fracturing by high TRS fine(0.5μm) WC grade.

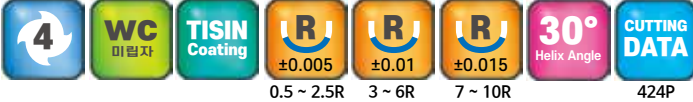

Condition	D Size	D Tolerance	Condition	D Size	D Tolerance
ØD ≠ Ød	Ø1 ~ 20	+0 ~ -0.01mm	ØD = Ød	Ø6 ~ 12	-0.005 ~ -0.015mm
				Ø14 ~ 20	-0.01 ~ -0.02mm

단위 : mm

Order Number	날경 Diameter R × D	날장 Length of cut L1	전장 Overall Length L	생크 Shank Dia d	비고
4HCB 010 025 S06	0.5R X 1	2.5	50	6	
4HCB 010 025 080	0.5R X 1	2.5	80	6	
4HCB 015 040 S06	0.75R X 1.5	4	50	6	
4HCB 015 040 080	0.75R X 1.5	4	80	6	
4HCB 020 050 S06	1R X 2	5	50	6	
4HCB 020 050 080	1R X 2	5	80	6	
4HCB 025 070 S06	1.25R X 2.5	7	50	6	
4HCB 025 070 080	1.25R X 2.5	7	80	6	
4HCB 030 080 S06	1.5R X 3	8	60	6	
4HCB 030 080 090	1.5R X 3	8	90	6	
4HCB 040 080 S04	2R X 4	8	60	4	
4HCB 040 080 090	2R X 4	8	90	4	
4HCB 040 080 S06	2R X 4	8	70	6	
4HCB 040 080 100	2R X 4	8	100	6	
4HCB 050 100 S06	2.5R X 5	10	80	6	
4HCB 050 100 110	2.5R X 5	10	110	6	
4HCB 060 120 S06	3R X 6	12	90	6	
4HCB 060 120 110	3R X 6	12	110	6	
4HCB 080 140 S08	4R X 8	14	100	8	
4HCB 080 140 150	4R X 8	14	150	8	
4HCB 100 180 S10	5R X 10	18	100	10	
4HCB 100 180 150	5R X 10	18	150	10	
4HCB 120 220 S12	6R X 12	22	110	12	
4HCB 120 220 150	6R X 12	22	150	12	
4HCB 140 240 110	7R X 14	24	110	14	
4HCB 160 300 S16	8R X 16	30	130	16	
4HCB 160 300 160	8R X 16	30	160	16	
4HCB 200 400 S20	10R X 20	40	160	20	
4HCB 200 400 200	10R X 20	40	200	20	

Order Number	날경 Diameter R × D	날장 Length of cut L1	전장 Overall Length L	생크 Shank Dia d	비고

# 2HRE 2 Flutes High Speed Rib End Mills

## 2날 고속가공용 리브 엔드밀

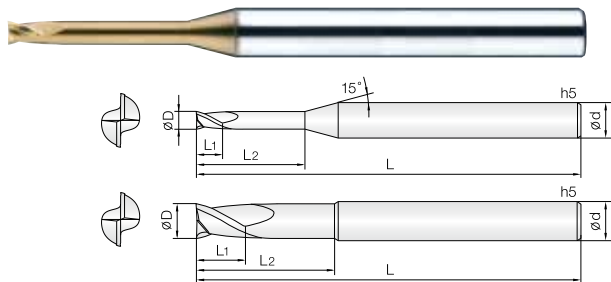

- 고경도강 (HRc50~60), 프리하든강 계열의 고정밀 가공 엔드밀
- 실리콘계 코팅 (Si) 처리하여 내마모성이 우수합니다.
- 고정밀 공차 적용으로 초정밀 가공에 적합합니다.
- 인선부 강성을 보장하여 날부치핑을 최소화 하였습니다.
- 초미립자 초경합금 (0.2µm)을 채택, 고속절삭시 뛰어난 성능을 발휘합니다.

- Endmills for pre-hardened and hardened steels(HRc50~65)
- Good wear resistance by Si-based PVD coating.
- High precise edge tolerance.
- High speed, feed applicable by 3 flute ball edge.
- Minimize fracturing by high TRS fine(0.5µm) WC grade.



Shield Edge 425P

Condition	D Size	D Tolerance	Condition	D Size	D Tolerance
ØD ≠ Ød	Ø0.1 ~ 0.15	+0 ~ -0.005mm	ØD = Ød	Ø6	-0.005 ~ -0.015mm
	Ø0.2 ~ 6	+0 ~ -0.01mm		Ø8 ~ 12	-0.01 ~ -0.025mm
	Ø8 ~ 12	+0 ~ -0.015mm			

단위 : mm

Order Number	날경 Diameter D	날장 Length of cut L1	유효장 Effective Length L2	전장 Overall Length L	생크 Shank Dia d	비고	Order Number	날경 Diameter D	날장 Length of cut L1	유효장 Effective Length L2	전장 Overall Length L	생크 Shank Dia d	비고
2HRE 001 003 S04	0.1	0.15	0.3	40	4		2HRE 006 050 S04	0.6	0.6	5	40	4	
2HRE 001 005 S04	0.1	0.15	0.5	40	4		2HRE 006 060 S04	0.6	0.6	6	40	4	
2HRE 0015 003 S04	0.15	0.15	0.3	40	4		2HRE 006 080 S04	0.6	0.6	8	40	4	
2HRE 0015 005 S04	0.15	0.15	0.5	40	4		2HRE 006 100 S04	0.6	0.6	10	40	4	
2HRE 0015 0075 S04	0.15	0.15	0.75	40	4		2HRE 006 120 S04	0.6	0.6	12	45	4	
2HRE 0015 010 S04	0.15	0.15	1	40	4		2HRE 006 140 S04	0.6	0.6	14	45	4	
2HRE 002 005 S04	0.2	0.2	0.5	40	4		2HRE 006 160 S04	0.6	0.6	16	45	4	
2HRE 002 010 S04	0.2	0.2	1	40	4		2HRE 007 020 S04	0.7	0.7	2	40	4	
2HRE 002 015 S04	0.2	0.2	1.5	40	4		2HRE 007 040 S04	0.7	0.7	4	40	4	
2HRE 002 020 S04	0.2	0.2	2	40	4		2HRE 007 060 S04	0.7	0.7	6	40	4	
2HRE 002 025 S04	0.2	0.2	2.5	40	4		2HRE 007 080 S04	0.7	0.7	8	40	4	
2HRE 002 030 S04	0.2	0.2	3	40	4		2HRE 007 100 S04	0.7	0.7	10	40	4	
2HRE 0025 005 S04	0.25	0.25	0.5	40	4		2HRE 007 120 S04	0.7	0.7	12	45	4	
2HRE 0025 010 S04	0.25	0.25	1	40	4		2HRE 008 020 S04	0.8	0.8	2	40	4	
2HRE 0025 015 S04	0.25	0.25	1.5	40	4		2HRE 008 030 S04	0.8	0.8	3	40	4	
2HRE 0025 020 S04	0.25	0.25	2	40	4		2HRE 008 040 S04	0.8	0.8	4	40	4	
2HRE 0025 030 S04	0.25	0.25	3	40	4		2HRE 008 050 S04	0.8	0.8	5	40	4	
2HRE 003 010 S04	0.3	0.3	1	40	4		2HRE 008 060 S04	0.8	0.8	6	40	4	
2HRE 003 015 S04	0.3	0.3	1.5	40	4		2HRE 008 080 S04	0.8	0.8	8	40	4	
2HRE 003 020 S04	0.3	0.3	2	40	4		2HRE 008 100 S04	0.8	0.8	10	40	4	
2HRE 003 025 S04	0.3	0.3	2.5	40	4		2HRE 008 120 S04	0.8	0.8	12	45	4	
2HRE 003 030 S04	0.3	0.3	3	40	4		2HRE 008 140 S04	0.8	0.8	14	45	4	
2HRE 003 035 S04	0.3	0.3	3.5	40	4		2HRE 009 060 S04	0.9	0.9	6	40	4	
2HRE 003 040 S04	0.3	0.3	4	40	4		2HRE 009 080 S04	0.9	0.9	8	40	4	
2HRE 003 050 S04	0.3	0.3	5	40	4		2HRE 009 100 S04	0.9	0.9	10	40	4	
2HRE 004 010 S04	0.4	0.4	1	40	4		2HRE 010 020 S04	1	1	2	45	4	
2HRE 004 015 S04	0.4	0.4	1.5	40	4		2HRE 010 030 S04	1	1	3	45	4	
2HRE 004 020 S04	0.4	0.4	2	40	4		2HRE 010 040 S04	1	1	4	45	4	
2HRE 004 025 S04	0.4	0.4	2.5	40	4		2HRE 010 050 S04	1	1	5	45	4	
2HRE 004 030 S04	0.4	0.4	3	40	4		2HRE 010 060 S04	1	1	6	45	4	
2HRE 004 035 S04	0.4	0.4	3.5	40	4		2HRE 010 080 S04	1	1	8	45	4	
2HRE 004 040 S04	0.4	0.4	4	40	4		2HRE 010 100 S04	1	1	10	45	4	
2HRE 004 050 S04	0.4	0.4	5	40	4		2HRE 010 120 S04	1	1	12	45	4	
2HRE 004 060 S04	0.4	0.4	6	40	4		2HRE 010 140 S04	1	1	14	45	4	
2HRE 004 080 S04	0.4	0.4	8	40	4		2HRE 010 160 S04	1	1	16	50	4	
2HRE 004 100 S04	0.4	0.4	10	40	4		2HRE 010 180 S04	1	1	18	50	4	
2HRE 005 010 S04	0.5	0.5	1	40	4		2HRE 010 200 S04	1	1	20	50	4	
2HRE 005 020 S04	0.5	0.5	2	40	4		2HRE 010 250 S04	1	1	25	60	4	
2HRE 005 030 S04	0.5	0.5	3	40	4		2HRE 010 300 S04	1	1	30	70	4	
2HRE 005 040 S04	0.5	0.5	4	40	4		2HRE 012 040 S04	1.2	1.2	4	45	4	
2HRE 005 050 S04	0.5	0.5	5	40	4		2HRE 012 060 S04	1.2	1.2	6	45	4	
2HRE 005 060 S04	0.5	0.5	6	40	4		2HRE 012 080 S04	1.2	1.2	8	45	4	
2HRE 005 080 S04	0.5	0.5	8	40	4		2HRE 012 100 S04	1.2	1.2	10	45	4	
2HRE 005 100 S04	0.5	0.5	10	40	4		2HRE 012 120 S04	1.2	1.2	12	45	4	
2HRE 005 120 S04	0.5	0.5	12	45	4		2HRE 012 160 S04	1.2	1.2	16	50	4	
2HRE 005 140 S04	0.5	0.5	14	45	4		2HRE 012 200 S04	1.2	1.2	20	50	4	
2HRE 006 010 S04	0.6	0.6	1	40	4		2HRE 012 250 S04	1.2	1.2	25	60	4	
2HRE 006 020 S04	0.6	0.6	2	40	4		2HRE 012 300 S04	1.2	1.2	30	70	4	
2HRE 006 030 S04	0.6	0.6	3	40	4		2HRE 014 060 S04	1.4	1.4	6	45	4	
2HRE 006 040 S04	0.6	0.6	4	40	4		2HRE 014 080 S04	1.4	1.4	8	45	4	

단위 : mm

Order Number	날경 Diameter D	날장 Length of cut L1	유효장 Effective Length L2	전장 Overall Length L	샙크 Shank Dia d	비고	Order Number	날경 Diameter D	날장 Length of cut L1	유효장 Effective Length L2	전장 Overall Length L	샙크 Shank Dia d	비고
2HRE 014 100 S04	1.4	1.4	10	45	4		2HRE 030 120 S06	3	3	12	50	6	
2HRE 014 140 S04	1.4	1.4	14	45	4		2HRE 030 160 S06	3	3	16	55	6	
2HRE 014 160 S04	1.4	1.4	16	50	4		2HRE 030 200 S06	3	3	20	60	6	
2HRE 014 200 S04	1.4	1.4	20	50	4		2HRE 030 250 S06	3	3	25	65	6	
2HRE 015 040 S04	1.5	1.5	4	45	4		2HRE 030 300 S06	3	3	30	70	6	
2HRE 015 060 S04	1.5	1.5	6	45	4		2HRE 030 350 S06	3	3	35	75	6	
2HRE 015 080 S04	1.5	1.5	8	45	4		2HRE 030 400 S06	3	3	40	80	6	
2HRE 015 100 S04	1.5	1.5	10	45	4		2HRE 030 450 S06	3	3	45	90	6	
2HRE 015 120 S04	1.5	1.5	12	45	4		2HRE 030 500 S06	3	3	50	100	6	
2HRE 015 140 S04	1.5	1.5	14	50	4		2HRE 030 600 S06	3	3	60	100	6	
2HRE 015 160 S04	1.5	1.5	16	50	4		2HRE 040 080 S06	4	4	8	50	6	
2HRE 015 180 S04	1.5	1.5	18	50	4		2HRE 040 100 S06	4	4	10	50	6	
2HRE 015 200 S04	1.5	1.5	20	50	4		2HRE 040 120 S06	4	4	12	50	6	
2HRE 015 250 S04	1.5	1.5	25	60	4		2HRE 040 160 S06	4	4	16	55	6	
2HRE 015 300 S04	1.5	1.5	30	70	4		2HRE 040 200 S06	4	4	20	60	6	
2HRE 016 100 S04	1.6	1.6	10	45	4		2HRE 040 250 S06	4	4	25	65	6	
2HRE 016 140 S04	1.6	1.6	14	45	4		2HRE 040 300 S06	4	4	30	70	6	
2HRE 016 180 S04	1.6	1.6	18	50	4		2HRE 040 350 S06	4	4	35	75	6	
2HRE 018 100 S04	1.8	1.8	10	45	4		2HRE 040 400 S06	4	4	40	80	6	
2HRE 018 140 S04	1.8	1.8	14	45	4		2HRE 040 450 S06	4	4	45	90	6	
2HRE 018 180 S04	1.8	1.8	18	50	4		2HRE 040 500 S06	4	4	50	100	6	
2HRE 020 040 S04	2	2	4	45	4		2HRE 040 550 S06	4	4	55	100	6	
2HRE 020 060 S04	2	2	6	45	4		2HRE 040 600 S06	4	4	60	100	6	
2HRE 020 080 S04	2	2	8	45	4		2HRE 050 160 S06	5	6	16	55	6	
2HRE 020 100 S04	2	2	10	45	4		2HRE 050 200 S06	5	6	20	60	6	
2HRE 020 120 S04	2	2	12	45	4		2HRE 050 250 S06	5	6	25	65	6	
2HRE 020 140 S04	2	2	14	45	4		2HRE 050 300 S06	5	6	30	70	6	
2HRE 020 160 S04	2	2	16	50	4		2HRE 050 350 S06	5	6	35	75	6	
2HRE 020 180 S04	2	2	18	50	4		2HRE 050 400 S06	5	6	40	80	6	
2HRE 020 200 S04	2	2	20	50	4		2HRE 050 500 S06	5	6	50	100	6	
2HRE 020 220 S04	2	2	22	60	4		2HRE 050 600 S06	5	6	60	100	6	
2HRE 020 250 S04	2	2	25	60	4		2HRE 060 200 S06	6	10	20	60	6	
2HRE 020 300 S04	2	2	30	60	4		2HRE 060 300 S06	6	10	30	75	6	
2HRE 020 350 S04	2	2	35	70	4		2HRE 060 400 S06	6	10	40	80	6	
2HRE 020 400 S04	2	2	40	80	4		2HRE 060 500 S06	6	10	50	90	6	
2HRE 020 450 S04	2	2	45	80	4		2HRE 060 600 S06	6	10	60	110	6	
2HRE 020 500 S04	2	2	50	90	4		2HRE 080 200 S08	8	12	20	65	8	
2HRE 025 080 S04	2.5	2.5	8	45	4		2HRE 080 300 S08	8	12	30	80	8	
2HRE 025 100 S04	2.5	2.5	10	45	4		2HRE 080 400 S08	8	12	40	100	8	
2HRE 025 120 S04	2.5	2.5	12	45	4		2HRE 100 250 S10	10	15	25	70	10	
2HRE 025 160 S04	2.5	2.5	16	50	4		2HRE 100 350 S10	10	15	35	80	10	
2HRE 025 200 S04	2.5	2.5	20	50	4		2HRE 100 450 S10	10	15	45	100	10	
2HRE 025 250 S04	2.5	2.5	25	60	4		2HRE 120 300 S12	12	18	30	80	12	
2HRE 025 300 S04	2.5	2.5	30	70	4		2HRE 120 400 S12	12	18	40	100	12	
2HRE 025 350 S04	2.5	2.5	35	70	4		2HRE 120 500 S12	12	18	50	120	12	
2HRE 025 400 S04	2.5	2.5	40	80	4								
2HRE 025 500 S04	2.5	2.5	50	90	4								
2HRE 030 060 S06	3	3	6	45	6								
2HRE 030 080 S06	3	3	8	45	6								
2HRE 030 100 S06	3	3	10	45	6								



# 4HRE 4 Flutes High Speed Rib End Mills

## 4날 고속가공용 리브 엔드밀

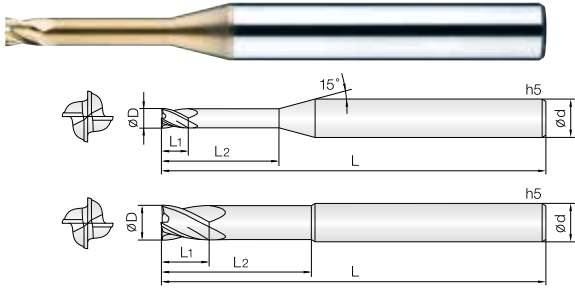

- 고경도강 (HRc50~60), 프리하든강 계열의 고정밀 가공 엔드밀
- 실리콘계 코팅 (Si) 처리하여 내마모성이 우수합니다.
- 고정밀 공차 적용으로 초정밀 가공에 적합합니다.
- 인선부 강성을 보강하여 날부치핑을 최소화 하였습니다.
- 초미립자 초경합금 (0.2 $\mu$ m)을 채택, 고속절삭시 뛰어난 성능을 발휘합니다.

### • Endmills for pre-hardened and hardened steels(HRc50~65)

- Good wear resistance by Si-based PVD coating.
- High precise edge tolerance.
- High speed, feed applicable by 3 flute ball edge.
- Minimize fracturing by high TRS fine(0.5 $\mu$ m) WC grade.



Shield Edge 428P

Condition	D Size	D Tolerance	Condition	D Size	D Tolerance
$\varnothing D \neq \varnothing d$	$\varnothing 0.5 \sim 6$	+0 ~ -0.01mm	$\varnothing D = \varnothing d$	$\varnothing 6$	-0.005 ~ -0.015mm
	$\varnothing 8 \sim 12$	+0 ~ -0.015mm		$\varnothing 8 \sim 12$	-0.01 ~ -0.025mm

단위 : mm

Order Number	날경 Diameter D	날장 Length of cut L1	유효장 Effective Length L2	전장 Overall Length L	생크 Shank Dia d	비고	Order Number	날경 Diameter D	날장 Length of cut L1	유효장 Effective Length L2	전장 Overall Length L	생크 Shank Dia d	비고
4HRE 005 010 S04	0.5	0.5	1	45	4		4HRE 015 060 S04	1.5	1.5	6	45	4	
4HRE 005 020 S04	0.5	0.5	2	45	4		4HRE 015 080 S04	1.5	1.5	8	45	4	
4HRE 005 030 S04	0.5	0.5	3	45	4		4HRE 015 100 S04	1.5	1.5	10	45	4	
4HRE 005 040 S04	0.5	0.5	4	45	4		4HRE 015 120 S04	1.5	1.5	12	45	4	
4HRE 005 050 S04	0.5	0.5	5	45	4		4HRE 015 160 S04	1.5	1.5	16	50	4	
4HRE 005 060 S04	0.5	0.5	6	45	4		4HRE 015 200 S04	1.5	1.5	20	50	4	
4HRE 005 080 S04	0.5	0.5	8	45	4		4HRE 015 250 S04	1.5	1.5	25	60	4	
4HRE 005 100 S04	0.5	0.5	10	50	4		4HRE 020 040 S04	2	2	4	45	4	
4HRE 006 010 S04	0.6	0.6	1	45	4		4HRE 020 060 S04	2	2	6	45	4	
4HRE 006 020 S04	0.6	0.6	2	45	4		4HRE 020 080 S04	2	2	8	45	4	
4HRE 006 030 S04	0.6	0.6	3	45	4		4HRE 020 100 S04	2	2	10	45	4	
4HRE 006 040 S04	0.6	0.6	4	45	4		4HRE 020 120 S04	2	2	12	45	4	
4HRE 006 060 S04	0.6	0.6	6	45	4		4HRE 020 140 S04	2	2	14	50	4	
4HRE 006 080 S04	0.6	0.6	8	45	4		4HRE 020 160 S04	2	2	16	50	4	
4HRE 006 100 S04	0.6	0.6	10	50	4		4HRE 020 180 S04	2	2	18	50	4	
4HRE 006 120 S04	0.6	0.6	12	50	4		4HRE 020 200 S04	2	2	20	50	4	
4HRE 007 020 S04	0.7	0.7	2	45	4		4HRE 020 250 S04	2	2	25	60	4	
4HRE 007 040 S04	0.7	0.7	4	45	4		4HRE 020 300 S04	2	2	30	70	4	
4HRE 007 060 S04	0.7	0.7	6	45	4		4HRE 025 100 S04	2.5	2.5	10	45	4	
4HRE 007 080 S04	0.7	0.7	8	45	4		4HRE 025 120 S04	2.5	2.5	12	45	4	
4HRE 007 100 S04	0.7	0.7	10	50	4		4HRE 025 160 S04	2.5	2.5	16	50	4	
4HRE 008 020 S04	0.8	0.8	2	45	4		4HRE 025 200 S04	2.5	2.5	20	50	4	
4HRE 008 040 S04	0.8	0.8	4	45	4		4HRE 025 250 S04	2.5	2.5	25	60	4	
4HRE 008 060 S04	0.8	0.8	6	45	4		4HRE 025 300 S04	2.5	2.5	30	70	4	
4HRE 008 080 S04	0.8	0.8	8	45	4		4HRE 030 060 S06	3	3	6	45	6	
4HRE 008 100 S04	0.8	0.8	10	45	4		4HRE 030 080 S06	3	3	8	45	6	
4HRE 008 120 S04	0.8	0.8	12	45	4		4HRE 030 100 S06	3	3	10	45	6	
4HRE 008 160 S04	0.8	0.8	16	50	4		4HRE 030 120 S06	3	3	12	50	6	
4HRE 009 020 S04	0.9	0.9	2	45	4		4HRE 030 160 S06	3	3	16	55	6	
4HRE 009 060 S04	0.9	0.9	6	45	4		4HRE 030 200 S06	3	3	20	60	6	
4HRE 009 080 S04	0.9	0.9	8	45	4		4HRE 030 250 S06	3	3	25	65	6	
4HRE 009 100 S04	0.9	0.9	10	45	4		4HRE 030 300 S06	3	3	30	70	6	
4HRE 010 020 S04	1	1	2	45	4		4HRE 030 350 S06	3	3	35	75	6	
4HRE 010 030 S04	1	1	3	45	4		4HRE 030 400 S06	3	3	40	80	6	
4HRE 010 040 S04	1	1	4	45	4		4HRE 030 450 S06	3	3	45	90	6	
4HRE 010 060 S04	1	1	6	45	4		4HRE 030 500 S06	3	3	50	100	6	
4HRE 010 080 S04	1	1	8	45	4		4HRE 035 120 S06	3.5	3.5	12	50	6	
4HRE 010 100 S04	1	1	10	45	4		4HRE 035 160 S06	3.5	3.5	16	55	6	
4HRE 010 120 S04	1	1	12	45	4		4HRE 035 200 S06	3.5	3.5	20	60	6	
4HRE 010 140 S04	1	1	14	50	4		4HRE 035 250 S06	3.5	3.5	25	65	6	
4HRE 010 160 S04	1	1	16	50	4		4HRE 035 300 S06	3.5	3.5	30	70	6	
4HRE 010 200 S04	1	1	20	50	4		4HRE 040 060 S06	4	4	6	50	6	
4HRE 010 250 S04	1	1	25	60	4		4HRE 040 080 S06	4	4	8	50	6	
4HRE 012 040 S04	1.2	1.2	4	45	4		4HRE 040 100 S06	4	4	10	50	6	
4HRE 012 060 S04	1.2	1.2	6	45	4		4HRE 040 120 S06	4	4	12	50	6	
4HRE 012 080 S04	1.2	1.2	8	45	4		4HRE 040 160 S06	4	4	16	55	6	
4HRE 012 100 S04	1.2	1.2	10	45	4		4HRE 040 200 S06	4	4	20	60	6	
4HRE 012 120 S04	1.2	1.2	12	45	4		4HRE 040 250 S06	4	4	25	65	6	
4HRE 012 160 S04	1.2	1.2	16	50	4		4HRE 040 300 S06	4	4	30	70	6	
4HRE 015 040 S04	1.5	1.5	4	45	4		4HRE 040 400 S06	4	4	40	80	6	

단위 : mm

Order Number	날경 Diameter D	날장 Length of cut L1	유효장 Effective Length L2	전장 Overall Length L	셱크 Shank Dia d	비고	Order Number	날경 Diameter D	날장 Length of cut L1	유효장 Effective Length L2	전장 Overall Length L	셱크 Shank Dia d	비고
4HRE 040 450 S06	4	4	45	90	6								
4HRE 040 500 S06	4	4	50	100	6								
4HRE 040 600 S06	4	4	60	110	6								
4HRE 045 120 S06	4.5	4.5	12	50	6								
4HRE 045 160 S06	4.5	4.5	16	55	6								
4HRE 045 200 S06	4.5	4.5	20	60	6								
4HRE 045 250 S06	4.5	4.5	25	65	6								
4HRE 045 300 S06	4.5	4.5	30	70	6								
4HRE 050 160 S06	5	5	16	55	6								
4HRE 050 200 S06	5	5	20	60	6								
4HRE 050 250 S06	5	5	25	65	6								
4HRE 050 300 S06	5	5	30	70	6								
4HRE 050 400 S06	5	5	40	80	6								
4HRE 050 500 S06	5	5	50	100	6								
4HRE 050 600 S06	5	5	60	110	6								
4HRE 060 200 S06	6	6	20	60	6								
4HRE 060 300 S06	6	6	30	75	6								
4HRE 060 400 S06	6	6	40	80	6								
4HRE 060 500 S06	6	6	50	90	6								
4HRE 060 600 S06	6	6	60	110	6								
4HRE 080 200 S08	8	10	20	65	8								
4HRE 080 300 S08	8	10	30	80	8								
4HRE 080 400 S08	8	10	40	100	8								
4HRE 100 250 S10	10	15	25	70	10								
4HRE 100 350 S10	10	15	35	90	10								
4HRE 100 450 S10	10	15	45	110	10								
4HRE 120 300 S12	12	18	30	80	12								
4HRE 120 400 S12	12	18	40	100	12								
4HRE 120 500 S12	12	18	50	120	12								



# 2HCE 2 Flutes High Speed Standard Length End Mills

## 2날 고속가공용 표준 길이 엔드밀

HARD series

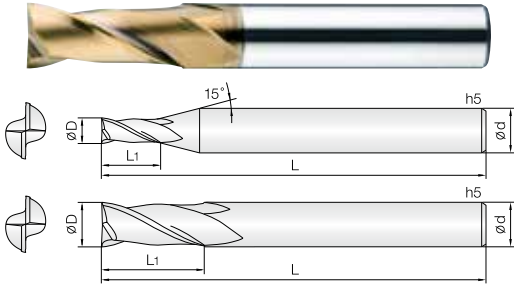

- 고경도강(HRc50~65), 프리하든강 계열의 고속 가공 엔드밀
- 실리콘계 코팅 (Si) 처리하여 내마모성이 우수합니다.
- 고정밀 공차 적용으로 초정밀 가공에 적합합니다.
- 인선부 강성을 보강하여 날부치핑을 최소화 하였습니다.
- 국내최초 날경 0.05mm 제품부터 생산합니다.
- 항절력이 높은 미립자 초경합금(0.5 $\mu$ m)을 채택, 엔드밀의 파손을 최소화 하였습니다.
- Endmills for pre-hardened and hardened steels(HRc50~65)
- Good wear resistance by Si-based PVD coating.
- High precise edge tolerance.
- Reinforced edge design for preventing edge chipping.
- Produce down to 0.05mm in diameter endmills at the first time in Korea.
- Minimize fracturing by high TRS fine(0.5 $\mu$ m) WC grade.



Condition	D Size	D Tolerance	Condition	D Size	D Tolerance
$\varnothing D \neq \varnothing d$	$\varnothing 0.05 \sim 0.15$	$+0 \sim -0.005\text{mm}$	$\varnothing D = \varnothing d$	$\varnothing 3 \sim 6$	$-0.005 \sim -0.015\text{mm}$
	$\varnothing 0.2 \sim 6$	$+0 \sim -0.01\text{mm}$		$\varnothing 8 \sim 12$	$-0.01 \sim -0.025\text{mm}$
	$\varnothing 6.1 \sim 20$	$+0 \sim -0.015\text{mm}$		$\varnothing 14 \sim 20$	$-0.015 \sim -0.03\text{mm}$

단위 : mm

Order Number	날경 Diameter D	날장 Length of cut L1	전장 Overall Length L	샙크 Shank Dia d	비고	Order Number	날경 Diameter D	날장 Length of cut L1	전장 Overall Length L	샙크 Shank Dia d	비고
2HCE 0005 0008 S04	0.05	0.08	40	4		2HCE 018 045 S04	1.8	4.5	40	4	
2HCE 0006 001 S04	0.06	0.1	40	4		2HCE 0185 045 S04	1.85	4.5	40	4	
2HCE 0007 0012 S04	0.07	0.12	40	4		2HCE 019 050 S04	1.9	5	40	4	
2HCE 0008 0015 S04	0.08	0.15	40	4		2HCE 0195 050 S04	1.95	5	40	4	
2HCE 0009 0017 S04	0.09	0.17	40	4		2HCE 020 060 S03	2	6	40	3	
2HCE 001 002 S04	0.1	0.2	40	4		2HCE 020 060 S04	2	6	40	4	
2HCE 0015 003 S04	0.15	0.3	40	4		2HCE 020 060 S06	2	6	40	6	
2HCE 002 004 S04	0.2	0.4	40	4		2HCE 020 060 060	2	6	60	6	
2HCE 0025 005 S04	0.25	0.5	40	4		2HCE 021 060 S04	2.1	6	40	4	
2HCE 003 006 S04	0.3	0.6	40	4		2HCE 022 060 S04	2.2	6	40	4	
2HCE 0035 007 S04	0.35	0.7	40	4		2HCE 023 060 S04	2.3	6	40	4	
2HCE 004 008 S04	0.4	0.8	40	4		2HCE 024 080 S04	2.4	8	45	4	
2HCE 0045 009 S04	0.45	0.9	40	4		2HCE 025 080 S03	2.5	8	45	3	
2HCE 005 010 S03	0.5	1	40	3		2HCE 025 080 S04	2.5	8	45	4	
2HCE 005 010 S04	0.5	1	40	4		2HCE 025 080 S06	2.5	8	45	6	
2HCE 0055 011 S04	0.55	1.1	40	4		2HCE 025 080 070	2.5	8	70	6	
2HCE 006 012 S03	0.6	1.2	40	3		2HCE 026 080 S04	2.6	8	45	4	
2HCE 006 012 S04	0.6	1.2	40	4		2HCE 027 080 S04	2.7	8	45	4	
2HCE 0065 013 S04	0.65	1.3	40	4		2HCE 028 080 S04	2.8	8	45	4	
2HCE 007 014 S04	0.7	1.4	40	4		2HCE 029 080 S04	2.9	8	45	4	
2HCE 0075 015 S04	0.75	1.5	40	4		2HCE 030 080 S03	3	8	45	3	
2HCE 008 016 S03	0.8	1.6	40	3		2HCE 030 080 S04	3	8	45	4	
2HCE 008 016 S04	0.8	1.6	40	4		2HCE 030 080 S06	3	8	45	6	
2HCE 0085 017 S04	0.85	1.7	40	4		2HCE 030 080 070	3	8	70	6	
2HCE 009 020 S04	0.9	2	40	4		2HCE 031 080 S06	3.1	8	45	6	
2HCE 0095 020 S04	0.95	2	40	4		2HCE 032 080 S06	3.2	8	45	6	
2HCE 010 025 S03	1	2.5	40	3		2HCE 033 080 S06	3.3	8	45	6	
2HCE 010 025 S04	1	2.5	40	4		2HCE 034 080 S06	3.4	8	45	6	
2HCE 010 025 S06	1	2.5	40	6		2HCE 035 100 S06	3.5	10	45	6	
2HCE 010 025 060	1	2.5	60	6		2HCE 036 100 S06	3.6	10	45	6	
2HCE 0105 025 S04	1.05	2.5	40	4		2HCE 037 100 S06	3.7	10	45	6	
2HCE 011 027 S04	1.1	2.7	40	4		2HCE 038 100 S06	3.8	10	45	6	
2HCE 0115 025 S04	1.15	2.5	40	4		2HCE 039 100 S06	3.9	10	45	6	
2HCE 012 030 S03	1.2	3	40	3		2HCE 040 100 S04	4	10	45	4	
2HCE 012 030 S04	1.2	3	40	4		2HCE 040 110 S06	4	11	45	6	
2HCE 012 030 060	1.2	3	60	6		2HCE 040 110 070	4	11	70	6	
2HCE 0125 030 S04	1.25	3	40	4		2HCE 041 110 S06	4.1	11	45	6	
2HCE 013 032 S04	1.3	3.2	40	4		2HCE 042 110 S06	4.2	11	45	6	
2HCE 0135 032 S04	1.35	3.2	40	4		2HCE 043 110 S06	4.3	11	45	6	
2HCE 014 035 S04	1.4	3.5	40	4		2HCE 044 110 S06	4.4	11	45	6	
2HCE 0145 035 S04	1.45	3.5	40	4		2HCE 045 110 S06	4.5	11	45	6	
2HCE 015 040 S03	1.5	4	40	3		2HCE 046 110 S06	4.6	11	45	6	
2HCE 015 040 S04	1.5	4	40	4		2HCE 047 110 S06	4.7	11	45	6	
2HCE 015 040 S06	1.5	4	40	6		2HCE 048 110 S06	4.8	11	45	6	
2HCE 015 040 060	1.5	4	60	6		2HCE 049 110 S06	4.9	11	45	6	
2HCE 0155 040 S04	1.55	4	40	4		2HCE 050 130 S06	5	13	50	6	
2HCE 016 040 S04	1.6	4	40	4		2HCE 050 130 080	5	13	80	6	
2HCE 0165 040 S04	1.65	4	40	4		2HCE 051 130 S06	5.1	13	50	6	
2HCE 017 042 S04	1.7	4.2	40	4		2HCE 052 130 S06	5.2	13	50	6	
2HCE 0175 042 S04	1.75	4.2	40	4		2HCE 053 130 S06	5.3	13	50	6	



단위 : mm

Order Number	날경 Diameter D	날장 Length of cut L1	전장 Overall Length L	생크 Shank Dia d	비고	Order Number	날경 Diameter D	날장 Length of cut L1	전장 Overall Length L	생크 Shank Dia d	비고
2HCE 054 130 S06	5.4	13	50	6							
2HCE 055 130 S06	5.5	13	50	6							
2HCE 056 130 S06	5.6	13	50	6							
2HCE 057 130 S06	5.7	13	50	6							
2HCE 058 130 S06	5.8	13	50	6							
2HCE 059 130 S06	5.9	13	50	6							
2HCE 060 130 S06	6	13	50	6							
2HCE 060 130 S08	6	13	80	6							
2HCE 061 150 S08	6.1	15	70	8							
2HCE 062 150 S08	6.2	15	70	8							
2HCE 063 150 S08	6.3	15	70	8							
2HCE 064 150 S08	6.4	15	70	8							
2HCE 065 160 S08	6.5	16	60	8							
2HCE 070 160 S08	7	16	60	8							
2HCE 075 160 S08	7.5	16	60	8							
2HCE 080 190 S08	8	19	60	8							
2HCE 085 190 S10	8.5	19	70	10							
2HCE 090 190 S10	9	19	70	10							
2HCE 095 190 S10	9.5	19	70	10							
2HCE 100 220 S10	10	22	70	10							
2HCE 105 220 S12	10.5	22	75	12							
2HCE 110 220 S12	11	22	75	12							
2HCE 115 220 S12	11.5	22	75	12							
2HCE 120 260 S12	12	26	75	12							
2HCE 130 260 S14	13	26	80	14							
2HCE 140 260 S14	14	26	80	14							
2HCE 140 260 S16	14	26	90	16							
2HCE 150 350 S16	15	35	100	16							
2HCE 160 350 S16	16	35	100	16							
2HCE 170 350 S18	17	35	100	18							
2HCE 180 350 S18	18	35	100	18							
2HCE 200 400 S20	20	40	100	20							

# 2LEM 2 Flutes Long Length End Mills

## 2날 긴 길이 엔드밀

HARD series

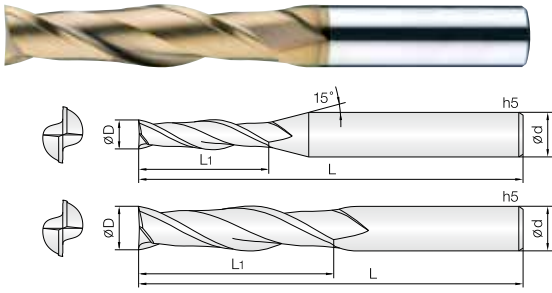

- HRC55 이하의 고경도강, 프리하든강, 공구강, 주철등 피삭재 가공
- 실리콘계 코팅 (Si) 처리하여 내마모성이 우수합니다.
- 균일한 런아웃 공차관리로 공구의 성능을 향상시켰습니다.
- 다양한 날길기와 전장을 채택, 다양한 작업에 효율성을 극대화 하였습니다.
- 코너부 강성을 보강하여 날부치평을 최소화 하였습니다.

- Endmills for various work materials, hardened steels (~HRC55), pre-hardened steels, tool steels and cast irons
- Good wear resistance by Si-based PVD coating.
- Improve tool performance by even run-out and tolerance control.
- Various flute and overall length design for covering wide range applications as well as high efficiency machining.
- Minimize edge chipping by improving corner strength.



Shield Edge 431P

Condition	D Size	D Tolerance	Condition	D Size	D Tolerance
∅D ≠ ∅d	∅1 ~ 6	+0 ~ -0.01mm	∅D = ∅d	∅6	-0.005 ~ -0.015mm
	∅8 ~ 25	+0 ~ -0.015mm		∅8 ~ 12	-0.01 ~ -0.025mm
		∅14 ~ 25		-0.015 ~ -0.03mm	

단위 : mm

Order Number	날경 Diameter D	날장 Length of cut L1	전장 Overall Length L	샙크 Shank Dia d	비고
2LEM 010 030 S06	1	3	60	6	
2LEM 010 050 S06	1	5	60	6	
2LEM 010 070 S06	1	7	60	6	
2LEM 010 100 S06	1	10	60	6	
2LEM 010 120 S06	1	12	60	6	
2LEM 010 150 S06	1	15	60	6	
2LEM 012 060 S06	1.2	6	60	6	
2LEM 012 080 S06	1.2	8	60	6	
2LEM 012 100 S06	1.2	10	60	6	
2LEM 012 120 S06	1.2	12	60	6	
2LEM 015 060 S06	1.5	6	60	6	
2LEM 015 075 S06	1.5	7.5	60	6	
2LEM 015 100 S06	1.5	10	60	6	
2LEM 015 150 S06	1.5	15	60	6	
2LEM 015 200 S06	1.5	20	60	6	
2LEM 020 060 S06	2	6	60	6	
2LEM 020 100 S06	2	10	60	6	
2LEM 020 150 S06	2	15	60	6	
2LEM 020 200 S06	2	20	60	6	
2LEM 025 100 S06	2.5	10	60	6	
2LEM 025 150 S06	2.5	15	60	6	
2LEM 025 200 S06	2.5	20	60	6	
2LEM 030 120 S06	3	12	70	6	
2LEM 030 150 S06	3	15	70	6	
2LEM 030 200 S06	3	20	70	6	
2LEM 030 250 S06	3	25	70	6	
2LEM 030 300 S06	3	30	70	6	
2LEM 035 120 S06	3.5	12	70	6	
2LEM 035 150 S06	3.5	15	70	6	
2LEM 035 200 S06	3.5	20	70	6	
2LEM 040 150 S06	4	15	70	6	
2LEM 040 200 S06	4	20	70	6	
2LEM 040 300 S06	4	30	75	6	
2LEM 040 350 S06	4	35	75	6	
2LEM 040 400 S06	4	40	80	6	
2LEM 045 120 S06	4.5	12	70	6	
2LEM 045 150 S06	4.5	15	70	6	
2LEM 045 200 S06	4.5	20	70	6	
2LEM 050 200 S06	5	20	80	6	
2LEM 050 250 S06	5	25	70	6	
2LEM 050 300 S06	5	30	75	6	
2LEM 050 400 S06	5	40	80	6	
2LEM 060 200 S06	6	20	75	6	
2LEM 060 200 100	6	20	100	6	
2LEM 060 250 S06	6	25	75	6	
2LEM 060 300 S06	6	30	80	6	
2LEM 060 350 S06	6	35	80	6	
2LEM 060 400 S06	6	40	90	6	
2LEM 060 450 S06	6	45	90	6	
2LEM 060 500 S06	6	50	100	6	

Order Number	날경 Diameter D	날장 Length of cut L1	전장 Overall Length L	샙크 Shank Dia d	비고
2LEM 080 250 S08	8	25	75	8	
2LEM 080 250 100	8	25	100	8	
2LEM 080 300 S08	8	30	80	8	
2LEM 080 350 S08	8	35	80	8	
2LEM 080 400 S08	8	40	90	8	
2LEM 080 450 S08	8	45	100	8	
2LEM 080 500 S08	8	50	100	8	
2LEM 080 550 S08	8	55	100	8	
2LEM 080 600 S08	8	60	110	8	
2LEM 100 300 S10	10	30	80	10	
2LEM 100 300 110	10	30	110	10	
2LEM 100 350 S10	10	35	90	10	
2LEM 100 400 S10	10	40	90	10	
2LEM 100 450 S10	10	45	100	10	
2LEM 100 500 S10	10	50	100	10	
2LEM 100 550 S10	10	55	110	10	
2LEM 100 600 S10	10	60	110	10	
2LEM 100 650 S10	10	65	120	10	
2LEM 100 700 S10	10	70	120	10	
2LEM 120 300 S12	12	30	90	12	
2LEM 120 350 110	12	35	110	12	
2LEM 120 400 S12	12	40	100	12	
2LEM 120 450 S12	12	45	100	12	
2LEM 120 500 S12	12	50	100	12	
2LEM 120 550 S12	12	55	110	12	
2LEM 120 600 S12	12	60	110	12	
2LEM 120 700 S12	12	70	130	12	
2LEM 120 800 S12	12	80	130	12	
2LEM 140 500 S14	14	50	110	14	
2LEM 160 400 160	16	40	160	16	
2LEM 160 550 S16	16	55	120	16	
2LEM 160 700 S16	16	70	130	16	
2LEM 160 800 S16	16	80	160	16	
2LEM 160 1000 S16	16	100	160	16	
2LEM 200 500 160	20	50	160	20	
2LEM 200 600 S20	20	60	130	20	
2LEM 200 1000 S20	20	100	200	20	
2LEM 250 750 S25	25	75	160	25	

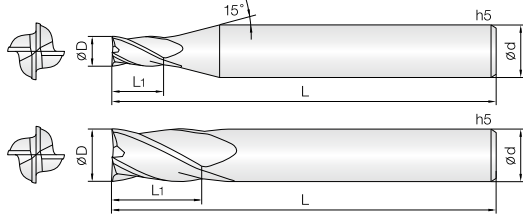

Shield Edge 430P

- 고경도강(HRc50~65), 프리하든강 계열의 고정밀 가공 엔드밀
- 실리콘계코팅(Si) 처리하여 내마모성이 우수합니다.
- 짧은 날장의 채택으로 강력절삭에 적합합니다.
- 인선부 강성을 보강하여 날부치핑을 최소화 하였습니다.
- 짧은 전장을 채택하여 열박음척 사용이 용이합니다.
- 항절력이 높은 미립자 초경합금(0.5µm)을 채택, 엔드밀의 파손을 최소화 하였습니다.

#### Endmills for pre-hardened and hardened steels(HRc50~65)

- Good wear resistance by Si-based PVD coating.
- Optimum for heavy condition by short flute design.
- Reinforced edge design for preventing edge chipping.
- Short overall length for easy use with shrinking chuck.
- Minimize fracturing by high TRS fine(0.5µm) WC grade.

Condition	D Size	D Tolerance	Condition	D Size	D Tolerance
∅D ≠ ∅d	∅0.5 ~ 6	+0 ~ -0.01mm	∅D = ∅d	∅4 ~ 6	-0.005 ~ -0.015mm
	∅8 ~ 16	+0 ~ -0.015mm		∅8 ~ 12	-0.01 ~ -0.025mm
		∅12 ~ 16		-0.015 ~ -0.03mm	

단위 : mm

Order Number	날경 Diameter D	날장 Length of cut L1	전장 Overall Length L	생크 Shank Dia d	비고	Order Number	날경 Diameter D	날장 Length of cut L1	전장 Overall Length L	생크 Shank Dia d	비고
4HSE 005 0075 S04	0.5	0.75	40	4							
4HSE 006 009 S04	0.6	0.9	40	4							
4HSE 008 012 S04	0.8	1.2	40	4							
4HSE 010 015 S04	1	1.5	40	4							
4HSE 012 020 S04	1.2	2	40	4							
4HSE 015 022 S04	1.5	2.2	40	4							
4HSE 020 035 S04	2	3.5	40	4							
4HSE 020 035 S06	2	3.5	40	6							
4HSE 025 038 S04	2.5	3.8	40	4							
4HSE 030 045 S04	3	4.5	40	4							
4HSE 030 045 S06	3	4.5	40	6							
4HSE 035 052 S06	3.5	5.2	40	6							
4HSE 040 060 S04	4	6	40	4							
4HSE 040 060 S06	4	6	40	6							
4HSE 045 068 S06	4.5	6.8	40	6							
4HSE 050 075 S06	5	7.5	45	6							
4HSE 060 090 S06	6	9	45	6							
4HSE 080 120 S08	8	12	55	8							
4HSE 100 150 S10	10	15	60	10							
4HSE 120 180 S12	12	18	65	12							
4HSE 160 240 S16	16	24	75	16							

HARD series

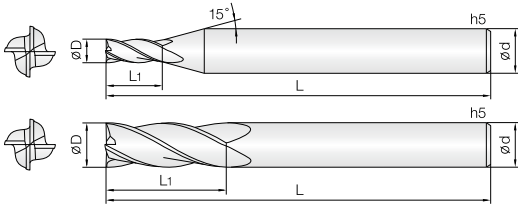

- 고경도강(HRc50~60), 프리하든강 계열의 고정밀 가공 엔드밀
- 실리콘계 코팅(Si) 처리하여 내마모성이 우수합니다.
- 고정밀 공차 적용으로 초정밀 가공에 적합합니다.
- 인선부 강성을 보강하여 날부치핑을 최소화 하였습니다.
- 항절력이 높은 미립자 초경합금(0.5 $\mu$ m)을 채택, 엔드밀의 파손을 최소화 하였습니다.

#### • Endmills for pre-hardened and hardened steels(HRc50~60)

- Good wear resistance by Si-based PVD coating.
- High precise edge tolerance.
- Reinforced edge design for preventing edge chipping.
- Minimize fracturing by high TRS fine(0.5 $\mu$ m) WC grade.



Shield Edge 430P

Condition	D Size	D Tolerance	Condition	D Size	D Tolerance
$\varnothing D \neq \varnothing d$	$\varnothing 0.3 \sim 6$	+0 ~ -0.01mm	$\varnothing D = \varnothing d$	$\varnothing 3 \sim 6$	-0.005 ~ -0.015mm
	$\varnothing 8 \sim 20$	+0 ~ -0.015mm		$\varnothing 8 \sim 12$	-0.01 ~ -0.025mm
		$\varnothing 14 \sim 20$		-0.015 ~ -0.03mm	

단위 : mm

Order Number	날경 Diameter D	날장 Length of cut L1	전장 Overall Length L	샤프크 Shank Dia d	비고
4HCE 003 006 S04	0.3	0.6	40	4	
4HCE 004 008 S04	0.4	0.8	40	4	
4HCE 005 010 S04	0.5	1	40	4	
4HCE 006 012 S04	0.6	1.2	40	4	
4HCE 007 014 S04	0.7	1.4	40	4	
4HCE 008 020 S04	0.8	2	40	4	
4HCE 009 018 S04	0.9	1.8	40	4	
4HCE 010 025 S03	1	2.5	40	3	
4HCE 010 025 S04	1	2.5	40	4	
4HCE 010 025 S06	1	2.5	40	6	
4HCE 010 025 060	1	2.5	60	6	
4HCE 010 025 080	1	2.5	80	6	
4HCE 012 030 S03	1.2	3	40	3	
4HCE 012 030 S04	1.2	3	40	4	
4HCE 012 030 S06	1.2	3	40	6	
4HCE 012 030 060	1.2	3	60	6	
4HCE 015 040 S03	1.5	4	40	3	
4HCE 015 040 S04	1.5	4	40	4	
4HCE 015 040 S06	1.5	4	40	6	
4HCE 015 040 060	1.5	4	60	6	
4HCE 015 040 080	1.5	4	80	6	
4HCE 020 060 S03	2	6	40	3	
4HCE 020 060 S04	2	6	40	4	
4HCE 020 060 S06	2	6	40	6	
4HCE 020 060 060	2	6	60	6	
4HCE 020 060 100	2	6	100	6	
4HCE 025 080 S03	2.5	8	45	3	
4HCE 025 080 S04	2.5	8	45	4	
4HCE 025 080 S06	2.5	8	45	6	
4HCE 025 080 070	2.5	8	70	6	
4HCE 025 080 100	2.5	8	100	6	
4HCE 030 080 S03	3	8	45	3	
4HCE 030 080 S04	3	8	45	4	
4HCE 030 080 S06	3	8	45	6	
4HCE 030 080 070	3	8	70	6	
4HCE 030 080 100	3	8	100	6	
4HCE 035 100 S06	3.5	10	45	6	
4HCE 040 110 S04	4	11	45	4	
4HCE 040 110 S06	4	11	45	6	
4HCE 040 110 070	4	11	70	6	
4HCE 040 110 100	4	11	100	6	
4HCE 045 110 S06	4.5	11	45	6	
4HCE 050 130 S06	5	13	50	6	
4HCE 050 130 080	5	13	80	6	
4HCE 050 130 100	5	13	100	6	
4HCE 055 130 S06	5.5	13	50	6	
4HCE 060 130 S06	6	13	50	6	
4HCE 060 130 080	6	13	80	6	
4HCE 060 130 100	6	13	100	6	
4HCE 065 160 S08	6.5	16	60	8	

Order Number	날경 Diameter D	날장 Length of cut L1	전장 Overall Length L	샤프크 Shank Dia d	비고
4HCE 070 160 S08	7	16	60	8	
4HCE 075 160 S08	7.5	16	60	8	
4HCE 080 190 S08	8	19	60	8	
4HCE 085 190 S10	8.5	19	70	10	
4HCE 090 190 S10	9	19	70	10	
4HCE 095 190 S10	9.5	19	70	10	
4HCE 100 220 S10	10	22	70	10	
4HCE 105 220 S12	10.5	22	75	12	
4HCE 110 220 S12	11	22	75	12	
4HCE 115 220 S12	11.5	22	75	12	
4HCE 120 260 S12	12	26	75	12	
4HCE 130 260 S14	13	26	80	14	
4HCE 140 260 S14	14	26	80	14	
4HCE 140 260 S16	14	26	90	16	
4HCE 150 350 S16	15	35	100	16	
4HCE 160 350 S16	16	35	100	16	
4HCE 170 350 S18	17	35	100	18	
4HCE 180 350 S18	18	35	100	18	
4HCE 200 400 S20	20	40	100	20	



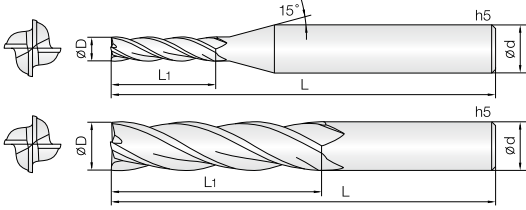

Shield Edge 431P

- HRc55 이하의 고경도강, 프리하드강, 공구강, 주철등 피삭재 가공
- 실리콘계 코팅 (Si) 처리하여 내마모성이 우수합니다.
- 균일한 런아웃 공차관리로 공구의 성능을 향상시켰습니다.
- 다양한 날길기와 전장을 채택, 다양한 작업에 효율성을 극대화 하였습니다.
- 코너부 강성을 보강하여 날부치핑을 최소화 하였습니다.

- Endmills for various work materials, hardened steels (~HRc55), pre-hardened steels, tool steels and cast irons
- Good wear resistance by Si-based PVD coating.
- Improve tool performance by even run-out and tolerance control.
- Various flute and overall length design for covering wide range applications as well as high efficiency machining.
- Minimize edge chipping by improving corner strength.

Condition	D Size	D Tolerance	Condition	D Size	D Tolerance
∅D ≠ ∅d	∅0.5 ~ 6	+0 ~ -0.01mm	∅D = ∅d	∅4 ~ 6	-0.005 ~ -0.015mm
	∅8 ~ 25	+0 ~ -0.015mm		∅8 ~ 12	-0.01 ~ -0.025mm
		∅14 ~ 25		-0.015 ~ -0.03mm	

단위 : mm

Order Number	날경 Diameter D	날장 Length of cut L1	전장 Overall Length L	샹크 Dia d	비고	Order Number	날경 Diameter D	날장 Length of cut L1	전장 Overall Length L	샹크 Dia d	비고
4LEM 005 015 S04	0.5	1.5	40	4		4LEM 050 300 S06	5	30	80	6	
4LEM 005 020 S04	0.5	2	40	4		4LEM 050 400 S06	5	40	80	6	
4LEM 006 018 S04	0.6	1.8	40	4		4LEM 050 500 S06	5	50	100	6	
4LEM 006 024 S04	0.6	2.4	40	4		4LEM 060 200 S06	6	20	75	6	
4LEM 008 024 S04	0.8	2.4	40	4		4LEM 060 200 100	6	20	100	6	
4LEM 008 032 S04	0.8	3.2	40	4		4LEM 060 250 S06	6	25	75	6	
4LEM 010 030 S06	1	3	60	6		4LEM 060 300 S06	6	30	80	6	
4LEM 010 050 S06	1	5	60	6		4LEM 060 350 S06	6	35	80	6	
4LEM 010 070 S06	1	7	60	6		4LEM 060 400 S06	6	40	90	6	
4LEM 010 100 S06	1	10	60	6		4LEM 060 450 S06	6	45	90	6	
4LEM 010 120 S06	1	12	60	6		4LEM 060 500 S06	6	50	100	6	
4LEM 012 040 S06	1.2	4	60	6		4LEM 080 250 S08	8	25	75	8	
4LEM 012 060 S06	1.2	6	60	6		4LEM 080 250 100	8	25	100	8	
4LEM 012 080 S06	1.2	8	60	6		4LEM 080 300 S08	8	30	80	8	
4LEM 012 100 S06	1.2	10	60	6		4LEM 080 350 S08	8	35	90	8	
4LEM 015 060 S06	1.5	6	60	6		4LEM 080 400 S08	8	40	90	8	
4LEM 015 080 S06	1.5	8	60	6		4LEM 080 450 S08	8	45	100	8	
4LEM 015 100 S06	1.5	10	60	6		4LEM 080 500 S08	8	50	100	8	
4LEM 015 120 S06	1.5	12	60	6		4LEM 080 550 S08	8	55	100	8	
4LEM 015 150 S06	1.5	15	60	6		4LEM 080 600 S08	8	60	110	8	
4LEM 020 080 S06	2	8	60	6		4LEM 100 300 S10	10	30	80	10	
4LEM 020 100 S06	2	10	60	6		4LEM 100 300 110	10	30	110	10	
4LEM 020 120 S06	2	12	60	6		4LEM 100 350 S10	10	35	90	10	
4LEM 020 150 S06	2	15	60	6		4LEM 100 400 S10	10	40	90	10	
4LEM 020 200 S06	2	20	70	6		4LEM 100 450 S10	10	45	100	10	
4LEM 030 100 S06	3	10	70	6		4LEM 100 500 S10	10	50	100	10	
4LEM 030 150 S06	3	15	70	6		4LEM 100 550 S10	10	55	100	10	
4LEM 030 200 S06	3	20	70	6		4LEM 100 600 S10	10	60	110	10	
4LEM 030 250 S06	3	25	70	6		4LEM 100 650 S10	10	65	120	10	
4LEM 030 300 S06	3	30	70	6		4LEM 100 700 S10	10	70	120	10	
4LEM 030 350 S06	3	35	75	6		4LEM 120 300 S12	12	30	90	12	
4LEM 030 400 S06	3	40	80	6		4LEM 120 350 110	12	35	110	12	
4LEM 035 120 S06	3.5	12	70	6		4LEM 120 400 S12	12	40	100	12	
4LEM 035 150 S06	3.5	15	70	6		4LEM 120 450 S12	12	45	100	12	
4LEM 035 200 S06	3.5	20	70	6		4LEM 120 500 S12	12	50	100	12	
4LEM 040 120 S06	4	12	70	6		4LEM 120 550 S12	12	55	110	12	
4LEM 040 150 S04	4	15	70	4		4LEM 120 600 S12	12	60	110	12	
4LEM 040 150 S06	4	15	70	6		4LEM 120 700 S12	12	70	130	12	
4LEM 040 200 S04	4	20	70	4		4LEM 120 800 S12	12	80	130	12	
4LEM 040 200 S06	4	20	70	6		4LEM 140 500 S14	14	50	110	14	
4LEM 040 250 S06	4	25	70	6		4LEM 160 400 160	16	40	160	16	
4LEM 040 300 S06	4	30	75	6		4LEM 160 550 S16	16	55	120	16	
4LEM 040 350 S06	4	35	75	6		4LEM 160 700 S16	16	70	130	16	
4LEM 040 400 S06	4	40	80	6		4LEM 160 900 S16	16	90	150	16	
4LEM 040 450 S06	4	45	90	6		4LEM 160 1000 S16	16	100	160	16	
4LEM 040 500 S06	4	50	100	6		4LEM 200 500 160	20	50	160	20	
4LEM 045 150 S06	4.5	15	70	6		4LEM 200 600 S20	20	60	130	20	
4LEM 045 200 S06	4.5	20	70	6		4LEM 200 800 S20	20	80	160	20	
4LEM 050 200 S06	5	20	70	6		4LEM 200 1000 S20	20	100	200	20	
4LEM 050 250 S06	5	25	75	6		4LEM 250 750 S25	25	75	160	25	

# 4HEM 4 Flutes High Speed 45° Helix End Mills

## 4날 고속가공용 45° 헬릭스 엔드밀

HARD series

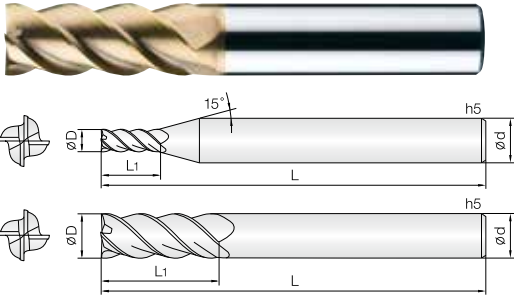

- 고경도강 (HRC50~62), 프리하든강 계열의 고정밀 가공 엔드밀
- 실리콘계 코팅 (Si) 처리하여 내마모성이 우수합니다.
- 고정밀 공차 적용으로 초정밀 가공에 적합합니다.
- 인선부 강성을 보강하여 날부치핑을 최소화 하였습니다.
- 45° 헬릭스 형상으로 설계하여 고속, 고이송 가공에 적합합니다.
- 초미립자 초경합금 (0.2μm) 을 채택, 고속절삭시 뛰어난 성능을 발휘합니다.

### Endmills for pre-hardened and hardened steels (HRC50~62)

- Good wear resistance by Si-based PVD coating.
- High precise edge tolerance.
- Reinforced edge design for preventing edge chipping.
- 45° degree helix design for high speed, feed condition.
- Outstanding performance at high speed machining by ultra fine (0.2μm) WC grade.

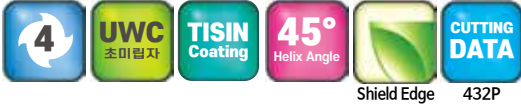

Shield Edge 432P

Condition	D Size	D Tolerance	Condition	D Size	D Tolerance
∅D ≠ ∅d	∅1 ~ 6	+0 ~ -0.01mm	∅D = ∅d	∅6	-0.005 ~ -0.015mm
	∅8 ~ 25	+0 ~ -0.015mm		∅8 ~ 12	-0.01 ~ -0.025mm
				∅14 ~ 25	-0.015 ~ -0.03mm

단위 : mm

Order Number	날경 Diameter D	날장 Length of cut L1	전장 Overall Length L	샙크 Dia d	비고
4HEM 010 025 S06	1	2.5	40	6	
4HEM 010 035 S06	1	3.5	40	6	
4HEM 010 050 S06	1	5	45	6	
4HEM 012 030 S06	1.2	3	40	6	
4HEM 015 040 S06	1.5	4	40	6	
4HEM 015 060 S06	1.5	6	40	6	
4HEM 015 080 S06	1.5	8	45	6	
4HEM 020 050 S06	2	5	40	6	
4HEM 020 080 S06	2	8	45	6	
4HEM 020 100 S06	2	10	50	6	
4HEM 030 080 S06	3	8	45	6	
4HEM 030 120 S06	3	12	50	6	
4HEM 030 150 S06	3	15	55	6	
4HEM 040 110 S06	4	11	45	6	
4HEM 040 160 S06	4	16	55	6	
4HEM 040 200 S06	4	20	60	6	
4HEM 050 130 S06	5	13	50	6	
4HEM 050 180 S06	5	18	60	6	
4HEM 050 250 S06	5	25	70	6	
4HEM 060 130 S06	6	13	50	6	
4HEM 060 200 S06	6	20	60	6	
4HEM 060 250 S06	6	25	70	6	
4HEM 080 200 S08	8	20	60	8	
4HEM 080 250 S08	8	25	70	8	
4HEM 080 300 S08	8	30	75	8	
4HEM 080 400 S08	8	40	90	8	
4HEM 100 220 S10	10	22	70	10	
4HEM 100 300 S10	10	30	80	10	
4HEM 100 400 S10	10	40	90	10	
4HEM 100 500 S10	10	50	100	10	
4HEM 120 260 S12	12	26	75	12	
4HEM 120 400 S12	12	40	90	12	
4HEM 120 500 S12	12	50	100	12	
4HEM 120 600 S12	12	60	110	12	
4HEM 140 300 S14	14	30	80	14	
4HEM 140 500 S14	14	50	110	14	
4HEM 160 350 S16	16	35	90	16	
4HEM 160 500 S16	16	50	110	16	
4HEM 160 650 S16	16	65	120	16	
4HEM 200 400 S20	20	40	100	20	
4HEM 200 500 S20	20	50	110	20	
4HEM 200 700 S20	20	70	130	20	
4HEM 250 800 S25	25	80	160	25	

# 6&8HEM 6 & 8 Flutes High Speed 45° Helix End Mills

## 6&8날 고속가공용 45° 헬릭스 엔드밀

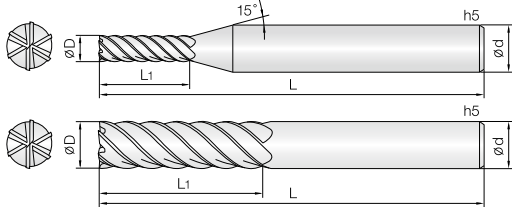

Shield Edge 432P

- 고경도강(HRC50~60), 프리하든강 계열의 고정밀 가공 엔드밀
- 실리콘계 코팅 (Si) 처리하여 내마모성이 우수합니다.
- 균일한 런아웃과 고정밀 공차 적용으로 초정밀가공에 적합합니다.
- 인선부 강성을 보강하여 날부치핑을 최소화 하였습니다.
- 45°헬릭스 형상으로 설계하여 고속, 고이송가공에 적합합니다.
- 초미립자 초경합금 (0.2 $\mu$ m)을 채택, 고속절삭시 뛰어난 성능을 발휘합니다.

### • Endmills for pre-hardened and hardened steels(HRC50~62)

- Good wear resistance by Si-based PVD coating.
- Precise run-out and tolerance for finish machining.
- Reinforced edge design for preventing edge chipping.
- 45° degree helix design for high speed, feed condition.
- Outstanding performance at high speed machining by ultra fine (0.2 $\mu$ m) WC grade.

Condition	D Size	D Tolerance	Condition	D Size	D Tolerance
$\varnothing D \neq \varnothing d$	$\varnothing 3 \sim 6$	+0 ~ -0.01mm	$\varnothing D = \varnothing d$	$\varnothing 6$	-0.005 ~ -0.015mm
	$\varnothing 8 \sim 25$	+0 ~ -0.015mm		$\varnothing 8 \sim 12$	-0.01 ~ -0.025mm
		$\varnothing 16 \sim 25$		-0.015 ~ -0.03mm	

단위 : mm

Order Number	날경 Diameter D	날장 Length of cut L1	전장 Overall Length L	생크 Shank Dia d	비고	Order Number	날경 Diameter D	날장 Length of cut L1	전장 Overall Length L	생크 Shank Dia d	비고
6HEM 030 100 S06	3	10	50	6							
6HEM 030 150 S06	3	15	50	6							
6HEM 040 120 S06	4	12	50	6							
6HEM 040 160 S06	4	16	50	6							
6HEM 050 150 S06	5	15	50	6							
6HEM 050 200 S06	5	20	60	6							
6HEM 060 150 S06	6	15	50	6							
6HEM 060 200 S06	6	20	60	6							
6HEM 060 250 S06	6	25	65	6							
6HEM 060 300 S06	6	30	70	6							
6HEM 060 350 S06	6	35	75	6							
6HEM 080 200 S08	8	20	60	8							
6HEM 080 250 S08	8	25	65	8							
6HEM 080 300 S08	8	30	75	8							
6HEM 080 350 S08	8	35	80	8							
6HEM 080 400 S08	8	40	90	8							
6HEM 080 450 S08	8	45	100	8							
6HEM 080 500 S08	8	50	100	8							
6HEM 100 250 S10	10	25	70	10							
6HEM 100 350 S10	10	35	90	10							
6HEM 100 450 S10	10	45	100	10							
6HEM 100 500 S10	10	50	100	10							
6HEM 100 600 S10	10	60	110	10							
6HEM 120 300 S12	12	30	80	12							
6HEM 120 400 S12	12	40	90	12							
6HEM 120 500 S12	12	50	100	12							
6HEM 120 600 S12	12	60	110	12							
6HEM 120 700 S12	12	70	120	12							
6HEM 160 350 S16	16	35	90	16							
6HEM 160 500 S16	16	50	110	16							
6HEM 160 650 S16	16	65	120	16							
6HEM 160 800 S16	16	80	150	16							
6HEM 160 900 S16	16	90	160	16							
6HEM 160 1000 S16	16	100	160	16							
6HEM 200 450 S20	20	45	100	20							
6HEM 200 600 S20	20	60	120	20							
6HEM 200 800 S20	20	80	150	20							
6HEM 200 900 S20	20	90	160	20							
6HEM 200 1000 S20	20	100	160	20							
6HEM 200 1100 S20	20	110	170	20							
6HEM 200 1200 S20	20	120	180	20							
8HEM 250 1000 S25	25	100	160	25							
8HEM 250 1250 S25	25	125	200	25							

HARD series







단위 : mm

Order Number	날경 D × R	날장 Length of cut L1	유효장 Effective Length L2	전장 Overall Length L	샙크 Dia d	비고	Order Number	날경 D × R	날장 Length of cut L1	유효장 Effective Length L2	전장 Overall Length L	샙크 Dia d	비고
2CRE 040 010 050	4 X R1	4	12	50	4		2CRE 100 015 240	10 X R1.5	11	24	70	10	
2CRE 040 010 070	4 X R1	4	20	70	4		2CRE 100 015 450	10 X R1.5	11	45	100	10	
2CRE 040 010 120	4 X R1	4	12	55	6		2CRE 100 020 240	10 X R2	11	24	70	10	
2CRE 040 010 160	4 X R1	4	16	55	6		2CRE 100 020 450	10 X R2	11	45	100	10	
2CRE 040 010 200	4 X R1	4	20	60	6		2CRE 120 002 260	12 X R0.2	13	26	80	12	
2CRE 040 010 250	4 X R1	4	25	65	6		2CRE 120 002 500	12 X R0.2	13	50	110	12	
2CRE 040 010 300	4 X R1	4	30	70	6		2CRE 120 003 260	12 X R0.3	13	26	80	12	
2CRE 040 010 350	4 X R1	4	35	75	6		2CRE 120 003 500	12 X R0.3	13	50	110	12	
2CRE 040 010 400	4 X R1	4	40	80	6		2CRE 120 005 260	12 X R0.5	13	26	80	12	
2CRE 040 010 450	4 X R1	4	45	90	6		2CRE 120 005 500	12 X R0.5	13	50	110	12	
2CRE 040 010 500	4 X R1	4	50	100	6		2CRE 120 005 700	12 X R0.5	13	70	130	12	
2CRE 050 002 150	5 X R0.2	6	15	60	6		2CRE 120 010 260	12 X R1	13	26	80	12	
2CRE 050 002 250	5 X R0.2	6	25	70	6		2CRE 120 010 500	12 X R1	13	50	110	12	
2CRE 050 002 300	5 X R0.2	6	30	70	6		2CRE 120 010 700	12 X R1	13	70	130	12	
2CRE 050 002 400	5 X R0.2	6	40	80	6		2CRE 120 015 260	12 X R1.5	13	26	80	12	
2CRE 050 002 500	5 X R0.2	6	50	100	6		2CRE 120 015 500	12 X R1.5	13	50	110	12	
2CRE 050 005 150	5 X R0.5	6	15	60	6		2CRE 120 020 260	12 X R2	13	26	80	12	
2CRE 050 005 250	5 X R0.5	6	25	70	6		2CRE 120 020 500	12 X R2	13	50	110	12	
2CRE 050 005 300	5 X R0.5	6	30	70	6		2CRE 120 030 260	12 X R3	13	26	80	12	
2CRE 050 005 400	5 X R0.5	6	40	80	6		2CRE 120 030 500	12 X R3	13	50	110	12	
2CRE 050 005 500	5 X R0.5	6	50	100	6		2CRE 160 005 110	16 X R0.5	20	40	110	16	
2CRE 050 010 150	5 X R1	6	15	60	6		2CRE 160 005 160	16 X R0.5	20	60	160	16	
2CRE 050 010 250	5 X R1	6	25	70	6		2CRE 160 010 110	16 X R1	20	40	110	16	
2CRE 050 010 300	5 X R1	6	30	70	6		2CRE 160 010 160	16 X R1	20	60	160	16	
2CRE 050 010 400	5 X R1	6	40	80	6								
2CRE 050 010 500	5 X R1	6	50	100	6								
2CRE 060 001 200	6 X R0.1	7	20	60	6								
2CRE 060 001 400	6 X R0.1	7	40	90	6								
2CRE 060 002 200	6 X R0.2	7	20	60	6								
2CRE 060 002 400	6 X R0.2	7	40	90	6								
2CRE 060 002 600	6 X R0.2	7	60	110	6								
2CRE 060 003 200	6 X R0.3	7	20	60	6								
2CRE 060 003 400	6 X R0.3	7	40	90	6								
2CRE 060 005 200	6 X R0.5	7	20	60	6								
2CRE 060 005 400	6 X R0.5	7	40	90	6								
2CRE 060 005 600	6 X R0.5	7	60	110	6								
2CRE 060 010 200	6 X R1	7	20	60	6								
2CRE 060 010 400	6 X R1	7	40	90	6								
2CRE 060 010 600	6 X R1	7	60	110	6								
2CRE 060 015 200	6 X R1.5	7	20	60	6								
2CRE 060 015 400	6 X R1.5	7	40	90	6								
2CRE 080 002 220	8 X R0.2	9	22	65	8								
2CRE 080 002 400	8 X R0.2	9	40	100	8								
2CRE 080 003 220	8 X R0.3	9	22	65	8								
2CRE 080 003 400	8 X R0.3	9	40	100	8								
2CRE 080 005 220	8 X R0.5	9	22	65	8								
2CRE 080 005 400	8 X R0.5	9	40	100	8								
2CRE 080 005 600	8 X R0.5	9	60	120	8								
2CRE 080 010 220	8 X R1	9	22	65	8								
2CRE 080 010 400	8 X R1	9	40	100	8								
2CRE 080 010 600	8 X R1	9	60	120	8								
2CRE 080 015 220	8 X R1.5	9	22	65	8								
2CRE 080 015 400	8 X R1.5	9	40	100	8								
2CRE 100 002 240	10 X R0.2	11	24	70	10								
2CRE 100 002 450	10 X R0.2	11	45	100	10								
2CRE 100 002 600	10 X R0.2	11	60	120	10								
2CRE 100 003 240	10 X R0.3	11	24	70	10								
2CRE 100 003 450	10 X R0.3	11	45	100	10								
2CRE 100 005 240	10 X R0.5	11	24	70	10								
2CRE 100 005 450	10 X R0.5	11	45	100	10								
2CRE 100 005 600	10 X R0.5	11	60	120	10								
2CRE 100 010 240	10 X R1	11	24	70	10								
2CRE 100 010 450	10 X R1	11	45	100	10								
2CRE 100 010 600	10 X R1	11	60	120	10								

HARD series



4날 리브 코너 레디우스 엔드밀

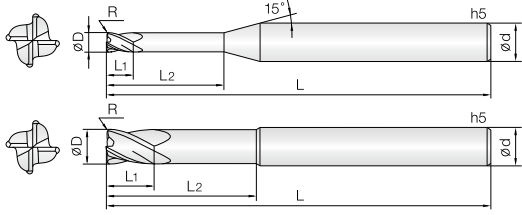

- 고경도강(HRC50~62), 프리하드강 계열의 고속 가공 엔드밀
실리콘계 코팅 (Si) 처리하여 내마모성이 우수합니다.
고정밀 공차 적용으로 초정밀 가공에 적합합니다.
코너R 형상을 날부치핑이 적도록 설계하였습니다.
다양한 코너R과 유효장으로 맞춤 가공이 가능합니다.
초미립자 초경합금(0.2μm)을 채택, 고속절삭시 뛰어난 성능을 발휘합니다.

Endmills for pre-hardened and hardened steels(HRC50~62)

- Good wear resistance by Si-based PVD coating.
High precise edge tolerance.
Designed for minimizing edge chipping by corner R shape.
Various corner R and flute length for wide range application.
Outstanding performance at high speed machining by ultra fine (0.2μm) WC grade.

Icons for 4, UWC, TISIN Coating, R, 30° Helix Angle, and CUTTING DATA

Table with columns: Condition, D Size, D Tolerance

R0.02 ~ 0.5 R1 ~ 1.5 R2 ~ 3 434P

단위 : mm

Main table with columns: Order Number, Diameter, Length of cut, Effective Length, Overall Length, Shank Dia, 비고

Main table with columns: Order Number, Diameter, Length of cut, Effective Length, Overall Length, Shank Dia, 비고





단위 : mm

HARD series

Order Number	날경 Diameter D×R	날장 Length of cut L1	유효장 Effective Length L2	전장 Overall Length L	샙크 Shank Dia d	비고	Order Number	날경 Diameter D×R	날장 Length of cut L1	유효장 Effective Length L2	전장 Overall Length L	샙크 Shank Dia d	비고
4CRE 020 005 180	2 X R0.5	2	18	50	4		4CRE 030 005 400	3 X R0.5	3	40	80	6	
4CRE 020 005 200	2 X R0.5	2	20	50	4		4CRE 030 005 500	3 X R0.5	3	50	100	6	
4CRE 020 005 220	2 X R0.5	2	22	60	4		4CRE 030 005 600	3 X R0.5	3	60	110	6	
4CRE 020 005 250	2 X R0.5	2	25	60	4		4CRE 030 010 100	3 X R1	3	10	50	6	
4CRE 020 005 300	2 X R0.5	2	30	70	4		4CRE 030 010 120	3 X R1	3	12	50	6	
4CRE 020 005 350	2 X R0.5	2	35	70	4		4CRE 030 010 160	3 X R1	3	16	55	6	
4CRE 025 001 100	2.5 X R0.1	2.5	10	50	4		4CRE 030 010 200	3 X R1	3	20	60	6	
4CRE 025 001 120	2.5 X R0.1	2.5	12	50	4		4CRE 030 010 250	3 X R1	3	25	65	6	
4CRE 025 001 160	2.5 X R0.1	2.5	16	50	4		4CRE 030 010 300	3 X R1	3	30	70	6	
4CRE 025 001 200	2.5 X R0.1	2.5	20	50	4		4CRE 030 010 350	3 X R1	3	35	75	6	
4CRE 025 001 250	2.5 X R0.1	2.5	25	60	4		4CRE 030 010 400	3 X R1	3	40	80	6	
4CRE 025 001 300	2.5 X R0.1	2.5	30	70	4		4CRE 030 010 500	3 X R1	3	50	100	6	
4CRE 025 002 100	2.5 X R0.2	2.5	10	50	4		4CRE 030 010 600	3 X R1	3	60	110	6	
4CRE 025 002 120	2.5 X R0.2	2.5	12	50	4		4CRE 040 001 050	4 X R0.1	4	12	50	4	
4CRE 025 002 160	2.5 X R0.2	2.5	16	50	4		4CRE 040 001 070	4 X R0.1	4	20	70	4	
4CRE 025 002 200	2.5 X R0.2	2.5	20	50	4		4CRE 040 001 130	4 X R0.1	4	13	55	6	
4CRE 025 002 250	2.5 X R0.2	2.5	25	60	4		4CRE 040 001 160	4 X R0.1	4	16	55	6	
4CRE 025 002 300	2.5 X R0.2	2.5	30	70	4		4CRE 040 001 200	4 X R0.1	4	20	60	6	
4CRE 025 003 100	2.5 X R0.3	2.5	10	50	4		4CRE 040 001 250	4 X R0.1	4	25	65	6	
4CRE 025 003 120	2.5 X R0.3	2.5	12	50	4		4CRE 040 001 300	4 X R0.1	4	30	70	6	
4CRE 025 003 160	2.5 X R0.3	2.5	16	50	4		4CRE 040 001 350	4 X R0.1	4	35	75	6	
4CRE 025 003 200	2.5 X R0.3	2.5	20	50	4		4CRE 040 001 400	4 X R0.1	4	40	80	6	
4CRE 025 003 250	2.5 X R0.3	2.5	25	60	4		4CRE 040 001 450	4 X R0.1	4	45	90	6	
4CRE 025 003 300	2.5 X R0.3	2.5	30	70	4		4CRE 040 001 500	4 X R0.1	4	50	100	6	
4CRE 025 005 100	2.5 X R0.5	2.5	10	50	4		4CRE 040 001 600	4 X R0.1	4	60	110	6	
4CRE 025 005 120	2.5 X R0.5	2.5	12	50	4		4CRE 040 002 050	4 X R0.2	4	12	50	4	
4CRE 025 005 160	2.5 X R0.5	2.5	16	50	4		4CRE 040 002 070	4 X R0.2	4	20	70	4	
4CRE 025 005 200	2.5 X R0.5	2.5	20	50	4		4CRE 040 002 130	4 X R0.2	4	13	55	6	
4CRE 025 005 250	2.5 X R0.5	2.5	25	60	4		4CRE 040 002 160	4 X R0.2	4	16	55	6	
4CRE 025 005 300	2.5 X R0.5	2.5	30	70	4		4CRE 040 002 200	4 X R0.2	4	20	60	6	
4CRE 030 001 100	3 X R0.1	3	10	50	6		4CRE 040 002 250	4 X R0.2	4	25	65	6	
4CRE 030 001 120	3 X R0.1	3	12	50	6		4CRE 040 002 300	4 X R0.2	4	30	70	6	
4CRE 030 001 160	3 X R0.1	3	16	55	6		4CRE 040 002 350	4 X R0.2	4	35	75	6	
4CRE 030 001 200	3 X R0.1	3	20	60	6		4CRE 040 002 400	4 X R0.2	4	40	80	6	
4CRE 030 001 250	3 X R0.1	3	25	65	6		4CRE 040 002 450	4 X R0.2	4	45	90	6	
4CRE 030 001 300	3 X R0.1	3	30	70	6		4CRE 040 002 500	4 X R0.2	4	50	100	6	
4CRE 030 001 350	3 X R0.1	3	35	75	6		4CRE 040 002 600	4 X R0.2	4	60	110	6	
4CRE 030 001 400	3 X R0.1	3	40	80	6		4CRE 040 003 050	4 X R0.3	4	12	50	4	
4CRE 030 001 500	3 X R0.1	3	50	100	6		4CRE 040 003 070	4 X R0.3	4	20	70	4	
4CRE 030 002 100	3 X R0.2	3	10	50	6		4CRE 040 003 130	4 X R0.3	4	13	55	6	
4CRE 030 002 120	3 X R0.2	3	12	50	6		4CRE 040 003 160	4 X R0.3	4	16	55	6	
4CRE 030 002 160	3 X R0.2	3	16	55	6		4CRE 040 003 200	4 X R0.3	4	20	60	6	
4CRE 030 002 200	3 X R0.2	3	20	60	6		4CRE 040 003 250	4 X R0.3	4	25	65	6	
4CRE 030 002 250	3 X R0.2	3	25	65	6		4CRE 040 003 300	4 X R0.3	4	30	70	6	
4CRE 030 002 300	3 X R0.2	3	30	70	6		4CRE 040 003 350	4 X R0.3	4	35	75	6	
4CRE 030 002 350	3 X R0.2	3	35	75	6		4CRE 040 003 400	4 X R0.3	4	40	80	6	
4CRE 030 002 400	3 X R0.2	3	40	80	6		4CRE 040 003 450	4 X R0.3	4	45	90	6	
4CRE 030 002 500	3 X R0.2	3	50	100	6		4CRE 040 003 500	4 X R0.3	4	50	100	6	
4CRE 030 003 100	3 X R0.3	3	10	50	6		4CRE 040 003 600	4 X R0.3	4	60	110	6	
4CRE 030 003 120	3 X R0.3	3	12	50	6		4CRE 040 005 050	4 X R0.5	4	12	50	4	
4CRE 030 003 160	3 X R0.3	3	16	55	6		4CRE 040 005 070	4 X R0.5	4	20	70	4	
4CRE 030 003 200	3 X R0.3	3	20	60	6		4CRE 040 005 130	4 X R0.5	4	13	55	6	
4CRE 030 003 250	3 X R0.3	3	25	65	6		4CRE 040 005 160	4 X R0.5	4	16	55	6	
4CRE 030 003 300	3 X R0.3	3	30	70	6		4CRE 040 005 200	4 X R0.5	4	20	60	6	
4CRE 030 003 350	3 X R0.3	3	35	75	6		4CRE 040 005 250	4 X R0.5	4	25	65	6	
4CRE 030 003 400	3 X R0.3	3	40	80	6		4CRE 040 005 300	4 X R0.5	4	30	70	6	
4CRE 030 003 500	3 X R0.3	3	50	100	6		4CRE 040 005 350	4 X R0.5	4	35	75	6	
4CRE 030 005 100	3 X R0.5	3	10	50	6		4CRE 040 005 400	4 X R0.5	4	40	80	6	
4CRE 030 005 120	3 X R0.5	3	12	50	6		4CRE 040 005 450	4 X R0.5	4	45	90	6	
4CRE 030 005 160	3 X R0.5	3	16	55	6		4CRE 040 005 500	4 X R0.5	4	50	100	6	
4CRE 030 005 200	3 X R0.5	3	20	60	6		4CRE 040 005 600	4 X R0.5	4	60	110	6	
4CRE 030 005 250	3 X R0.5	3	25	65	6		4CRE 040 010 050	4 X R1	4	12	50	4	
4CRE 030 005 300	3 X R0.5	3	30	70	6		4CRE 040 010 070	4 X R1	4	20	70	4	
4CRE 030 005 350	3 X R0.5	3	35	75	6		4CRE 040 010 130	4 X R1	4	13	55	6	

단위 : mm

Order Number	날경 D×R	날장 Length of cut L1	유효장 Effective Length L2	전장 Overall Length L	샙크 Shank Dia d	비고	Order Number	날경 D×R	날장 Length of cut L1	유효장 Effective Length L2	전장 Overall Length L	샙크 Shank Dia d	비고
4CRE 040 010 160	4 X R1	4	16	55	6		4CRE 080 020 220	8 X R2	9	22	65	8	
4CRE 040 010 200	4 X R1	4	20	60	6		4CRE 080 020 400	8 X R2	9	40	100	8	
4CRE 040 010 250	4 X R1	4	25	65	6		4CRE 100 002 240	10 X R0.2	11	24	70	10	
4CRE 040 010 300	4 X R1	4	30	70	6		4CRE 100 002 400	10 X R0.2	11	40	100	10	
4CRE 040 010 350	4 X R1	4	35	75	6		4CRE 100 003 240	10 X R0.3	11	24	70	10	
4CRE 040 010 400	4 X R1	4	40	80	6		4CRE 100 003 400	10 X R0.3	11	40	100	10	
4CRE 040 010 450	4 X R1	4	45	90	6		4CRE 100 005 240	10 X R0.5	11	24	70	10	
4CRE 040 010 500	4 X R1	4	50	100	6		4CRE 100 005 400	10 X R0.5	11	40	100	10	
4CRE 040 010 600	4 X R1	4	60	110	6		4CRE 100 005 600	10 X R0.5	11	60	120	10	
4CRE 050 001 160	5 X R0.1	5	16	60	6		4CRE 100 010 240	10 X R1	11	24	70	10	
4CRE 050 001 300	5 X R0.1	5	30	70	6		4CRE 100 010 400	10 X R1	11	40	100	10	
4CRE 050 001 400	5 X R0.1	5	40	80	6		4CRE 100 010 600	10 X R1	11	60	120	10	
4CRE 050 001 500	5 X R0.1	5	50	100	6		4CRE 100 015 240	10 X R1.5	11	24	70	10	
4CRE 050 002 160	5 X R0.2	5	16	60	6		4CRE 100 015 400	10 X R1.5	11	40	100	10	
4CRE 050 002 300	5 X R0.2	5	30	70	6		4CRE 100 020 240	10 X R2	11	24	70	10	
4CRE 050 002 400	5 X R0.2	5	40	80	6		4CRE 100 020 400	10 X R2	11	40	100	10	
4CRE 050 002 500	5 X R0.2	5	50	100	6		4CRE 100 025 240	10 X R2.5	11	24	70	10	
4CRE 050 003 160	5 X R0.3	5	16	60	6		4CRE 120 003 260	12 X R0.3	13	26	80	12	
4CRE 050 003 300	5 X R0.3	5	30	70	6		4CRE 120 005 260	12 X R0.5	13	26	80	12	
4CRE 050 003 400	5 X R0.3	5	40	80	6		4CRE 120 005 400	12 X R0.5	13	40	110	12	
4CRE 050 003 500	5 X R0.3	5	50	100	6		4CRE 120 005 600	12 X R0.5	13	60	130	12	
4CRE 050 005 160	5 X R0.5	5	16	60	6		4CRE 120 010 260	12 X R1	13	26	80	12	
4CRE 050 005 300	5 X R0.5	5	30	70	6		4CRE 120 010 400	12 X R1	13	40	110	12	
4CRE 050 005 400	5 X R0.5	5	40	80	6		4CRE 120 010 600	12 X R1	13	60	130	12	
4CRE 050 005 500	5 X R0.5	5	50	100	6		4CRE 120 015 260	12 X R1.5	13	26	80	12	
4CRE 050 005 600	5 X R0.5	5	60	110	6		4CRE 120 015 400	12 X R1.5	13	40	110	12	
4CRE 050 010 160	5 X R1	5	16	60	6		4CRE 120 020 260	12 X R2	13	26	80	12	
4CRE 050 010 300	5 X R1	5	30	70	6		4CRE 120 020 400	12 X R2	13	40	110	12	
4CRE 050 010 400	5 X R1	5	40	80	6		4CRE 120 030 260	12 X R3	13	26	80	12	
4CRE 050 010 500	5 X R1	5	50	100	6								
4CRE 050 010 600	5 X R1	5	60	110	6								
4CRE 060 001 200	6 X R0.1	7	20	60	6								
4CRE 060 001 400	6 X R0.1	7	40	80	6								
4CRE 060 001 500	6 X R0.1	7	50	100	6								
4CRE 060 002 200	6 X R0.2	7	20	60	6								
4CRE 060 002 400	6 X R0.2	7	40	80	6								
4CRE 060 002 500	6 X R0.2	7	50	100	6								
4CRE 060 002 600	6 X R0.2	7	60	110	6								
4CRE 060 003 200	6 X R0.3	7	20	60	6								
4CRE 060 003 400	6 X R0.3	7	40	80	6								
4CRE 060 003 500	6 X R0.3	7	50	100	6								
4CRE 060 005 200	6 X R0.5	7	20	60	6								
4CRE 060 005 400	6 X R0.5	7	40	80	6								
4CRE 060 005 500	6 X R0.5	7	50	100	6								
4CRE 060 005 600	6 X R0.5	7	60	110	6								
4CRE 060 010 200	6 X R1	7	20	60	6								
4CRE 060 010 400	6 X R1	7	40	80	6								
4CRE 060 010 500	6 X R1	7	50	100	6								
4CRE 060 010 600	6 X R1	7	60	110	6								
4CRE 060 015 200	6 X R1.5	7	20	60	6								
4CRE 060 015 400	6 X R1.5	7	40	80	6								
4CRE 060 015 500	6 X R1.5	7	50	100	6								
4CRE 080 002 220	8 X R0.2	9	22	65	8								
4CRE 080 002 400	8 X R0.2	9	40	100	8								
4CRE 080 003 220	8 X R0.3	9	22	65	8								
4CRE 080 003 400	8 X R0.3	9	40	100	8								
4CRE 080 005 220	8 X R0.5	9	22	65	8								
4CRE 080 005 400	8 X R0.5	9	40	100	8								
4CRE 080 005 600	8 X R0.5	9	60	120	8								
4CRE 080 010 220	8 X R1	9	22	65	8								
4CRE 080 010 400	8 X R1	9	40	100	8								
4CRE 080 010 600	8 X R1	9	60	120	8								
4CRE 080 015 220	8 X R1.5	9	22	65	8								
4CRE 080 015 400	8 X R1.5	9	40	100	8								

HARD series

# 2NCR 2 Flutes Corner Radius End Mills

## 2날 코너 레디우스 엔드밀

HARD series

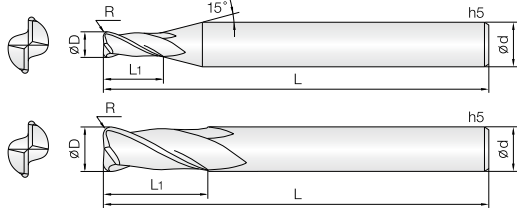

- 고경도강(HRc50~62), 프리하드강 계열의 고속 가공 엔드밀
- 실리콘계 코팅 (Si) 처리하여 내마모성이 우수합니다.
- 고정밀 공차 적용으로 초정밀 가공에 적합합니다.
- 코너R 형상을 날부치핑이 적도록 설계하였습니다.
- 다양한 코너R과 유효장으로 맞춤 가공이 가능합니다.
- 초미립자 초경합금(0.2 $\mu$ m)을 채택, 고속절삭시 뛰어난 성능을 발휘합니다.
- Endmills for pre-hardened and hardened steels(HRc50~62)
- Good wear resistance by Si-based PVD coating.
- High precise edge tolerance.
- Designed for minimizing edge chipping by corner R shape.
- Various corner R and flute length for wide range application.
- Outstanding performance at high speed machining by ultra fine (0.2 $\mu$ m) WC grade.

Condition	D Size	D Tolerance	Condition	D Size	D Tolerance
$\varnothing D \neq \varnothing d$	$\varnothing 0.2 \sim 16$	$+0 \sim -0.01\text{mm}$	$\varnothing D = \varnothing d$	$\varnothing 4 \sim 12$	$-0.005 \sim -0.015\text{mm}$
				$\varnothing 14 \sim 16$	$-0.01 \sim -0.02\text{mm}$

단위 : mm

Order Number	날경 Diameter D×R	날장 Length of cut L1	전장 Overall Length L	샤프트 Shank Dia d	비고	Order Number	날경 Diameter D×R	날장 Length of cut L1	전장 Overall Length L	샤프트 Shank Dia d	비고
2NCR 002 0002 S04	0.2 X R0.02	0.6	45	4		2NCR 025 002 S04	2.5 X R0.2	6	50	4	
2NCR 002 0005 S04	0.2 X R0.05	0.6	45	4		2NCR 025 003 S04	2.5 X R0.3	6	50	4	
2NCR 003 0002 S04	0.3 X R0.02	0.6	45	4		2NCR 025 004 S04	2.5 X R0.4	6	50	4	
2NCR 003 0005 S04	0.3 X R0.05	0.6	45	4		2NCR 025 005 S04	2.5 X R0.5	6	50	4	
2NCR 003 001 S04	0.3 X R0.1	0.6	45	4		2NCR 030 0005 S06	3 X R0.05	8	60	6	
2NCR 004 0002 S04	0.4 X R0.02	0.8	45	4		2NCR 030 001 S06	3 X R0.1	8	60	6	
2NCR 004 0005 S04	0.4 X R0.05	0.8	45	4		2NCR 030 002 S06	3 X R0.2	8	60	6	
2NCR 004 001 S04	0.4 X R0.1	0.8	45	4		2NCR 030 003 S06	3 X R0.3	8	60	6	
2NCR 005 0002 S04	0.5 X R0.02	1	45	4		2NCR 030 004 S06	3 X R0.4	8	60	6	
2NCR 005 0005 S04	0.5 X R0.05	1	45	4		2NCR 030 005 S06	3 X R0.5	8	60	6	
2NCR 005 001 S04	0.5 X R0.1	1	45	4		2NCR 030 010 S06	3 X R1	8	60	6	
2NCR 006 0002 S04	0.6 X R0.02	1.2	45	4		2NCR 035 001 S06	3.5 X R0.1	9	70	6	
2NCR 006 0005 S04	0.6 X R0.05	1.2	45	4		2NCR 035 002 S06	3.5 X R0.2	9	70	6	
2NCR 006 001 S04	0.6 X R0.1	1.2	45	4		2NCR 035 003 S06	3.5 X R0.3	9	70	6	
2NCR 006 002 S04	0.6 X R0.2	1.2	45	4		2NCR 035 005 S06	3.5 X R0.5	9	70	6	
2NCR 007 0005 S04	0.7 X R0.05	1.4	45	4		2NCR 035 010 S06	3.5 X R1	9	70	6	
2NCR 007 001 S04	0.7 X R0.1	1.4	45	4		2NCR 040 0005 060	4 X R0.05	9	60	4	
2NCR 007 002 S04	0.7 X R0.2	1.4	45	4		2NCR 040 0005 080	4 X R0.05	9	80	4	
2NCR 008 0002 S04	0.8 X R0.02	1.6	45	4		2NCR 040 0005 S06	4 X R0.05	9	70	6	
2NCR 008 0005 S04	0.8 X R0.05	1.6	45	4		2NCR 040 001 060	4 X R0.1	9	60	4	
2NCR 008 001 S04	0.8 X R0.1	1.6	45	4		2NCR 040 001 080	4 X R0.1	9	80	4	
2NCR 008 002 S04	0.8 X R0.2	1.6	45	4		2NCR 040 001 S06	4 X R0.1	10	70	6	
2NCR 009 0005 S04	0.9 X R0.05	1.8	45	4		2NCR 040 002 060	4 X R0.2	9	60	4	
2NCR 009 001 S04	0.9 X R0.1	1.8	45	4		2NCR 040 002 080	4 X R0.2	9	80	4	
2NCR 010 0002 S04	1 X R0.02	2.5	45	4		2NCR 040 002 S06	4 X R0.2	10	70	6	
2NCR 010 0005 S04	1 X R0.05	2.5	45	4		2NCR 040 003 060	4 X R0.3	9	60	4	
2NCR 010 001 S04	1 X R0.1	2.5	45	4		2NCR 040 003 080	4 X R0.3	9	80	4	
2NCR 010 002 S04	1 X R0.2	2.5	45	4		2NCR 040 003 S06	4 X R0.3	10	70	6	
2NCR 010 003 S04	1 X R0.3	2.5	45	4		2NCR 040 004 060	4 X R0.4	9	60	4	
2NCR 010 004 S04	1 X R0.4	2.5	45	4		2NCR 040 004 080	4 X R0.4	9	80	4	
2NCR 012 0005 S04	1.2 X R0.05	3.2	45	4		2NCR 040 004 S06	4 X R0.4	10	70	6	
2NCR 012 001 S04	1.2 X R0.1	3.2	45	4		2NCR 040 005 060	4 X R0.5	9	60	4	
2NCR 012 002 S04	1.2 X R0.2	3.2	45	4		2NCR 040 005 080	4 X R0.5	9	80	4	
2NCR 012 003 S04	1.2 X R0.3	3.2	45	4		2NCR 040 005 S06	4 X R0.5	10	70	6	
2NCR 015 0002 S04	1.5 X R0.02	4	45	4		2NCR 040 010 060	4 X R1	9	60	4	
2NCR 015 0005 S04	1.5 X R0.05	4	45	4		2NCR 040 010 080	4 X R1	9	80	4	
2NCR 015 001 S04	1.5 X R0.1	4	45	4		2NCR 040 010 S06	4 X R1	10	70	6	
2NCR 015 002 S04	1.5 X R0.2	4	45	4		2NCR 045 001 S06	4.5 X R0.1	11	75	6	
2NCR 015 003 S04	1.5 X R0.3	4	45	4		2NCR 045 002 S06	4.5 X R0.2	11	75	6	
2NCR 015 004 S04	1.5 X R0.4	4	45	4		2NCR 045 003 S06	4.5 X R0.3	11	75	6	
2NCR 015 005 S04	1.5 X R0.5	4	45	4		2NCR 045 005 S06	4.5 X R0.5	11	75	6	
2NCR 020 0002 S04	2 X R0.02	6	45	4		2NCR 045 010 S06	4.5 X R1	11	75	6	
2NCR 020 0005 S04	2 X R0.05	6	45	4		2NCR 050001 S06	5 X R0.1	13	75	6	
2NCR 020 001 S04	2 X R0.1	6	45	4		2NCR 050 002 S06	5 X R0.2	13	75	6	
2NCR 020 002 S04	2 X R0.2	6	45	4		2NCR 050 003 S06	5 X R0.3	13	75	6	
2NCR 020 003 S04	2 X R0.3	6	45	4		2NCR 050 004 S06	5 X R0.4	13	75	6	
2NCR 020 004 S04	2 X R0.4	6	45	4		2NCR 050 005 S06	5 X R0.5	13	75	6	
2NCR 020 005 S04	2 X R0.5	6	45	4		2NCR 050 010 S06	5 X R1	13	75	6	
2NCR 025 0005 S04	2.5 X R0.05	6	50	4		2NCR 055 002 S06	5.5 X R0.2	13	75	6	
2NCR 025 001 S04	2.5 X R0.1	6	50	4		2NCR 055 003 S06	5.5 X R0.3	13	75	6	

단위 : mm

Order Number	날경 Diameter D×R	날장 Length of cut L1	전장 Overall Length L	샙크 Dia d	비고	Order Number	날경 Diameter D×R	날장 Length of cut L1	전장 Overall Length L	샙크 Dia d	비고
2NCR 055 005 S06	5.5 X R0.5	13	75	6		2NCR 100 010 100	10 X R1	22	100	10	
2NCR 055 010 S06	5.5 X R1	13	75	6		2NCR 100 010 130	10 X R1	22	130	10	
2NCR 060 0005 060	6 X R0.05	11	60	6		2NCR 100 015 075	10 X R1.5	19	75	10	
2NCR 060 0005 090	6 X R0.05	13	90	6		2NCR 100 015 100	10 X R1.5	22	100	10	
2NCR 060 001 060	6 X R0.1	11	60	6		2NCR 100 015 130	10 X R1.5	22	130	10	
2NCR 060 001 090	6 X R0.1	13	90	6		2NCR 100 020 075	10 X R2	19	75	10	
2NCR 060 002 060	6 X R0.2	11	60	6		2NCR 100 020 100	10 X R2	22	100	10	
2NCR 060 002 090	6 X R0.2	13	90	6		2NCR 100 025 100	10 X R2.5	22	100	10	
2NCR 060 003 060	6 X R0.3	11	60	6		2NCR 100 030 100	10 X R3	22	100	10	
2NCR 060 003 090	6 X R0.3	13	90	6		2NCR 100 040 100	10 X R4	22	100	10	
2NCR 060 004 060	6 X R0.4	11	60	6		2NCR 120 001 080	12 X R0.1	22	80	12	
2NCR 060 004 090	6 X R0.4	13	90	6		2NCR 120 001 110	12 X R0.1	26	110	12	
2NCR 060 005 060	6 X R0.5	11	60	6		2NCR 120 002 080	12 X R0.2	22	80	12	
2NCR 060 005 090	6 X R0.5	13	90	6		2NCR 120 002 110	12 X R0.2	26	110	12	
2NCR 060 010 060	6 X R1	11	60	6		2NCR 120 003 080	12 X R0.3	22	80	12	
2NCR 060 010 090	6 X R1	13	90	6		2NCR 120 003 110	12 X R0.3	26	110	12	
2NCR 060 015 060	6 X R1.5	11	60	6		2NCR 120 005 080	12 X R0.5	22	80	12	
2NCR 060 015 090	6 X R1.5	13	90	6		2NCR 120 005 110	12 X R0.5	26	110	12	
2NCR 060 020 060	6 X R2	11	60	6		2NCR 120 005 130	12 X R0.5	26	130	12	
2NCR 060 020 090	6 X R2	13	90	6		2NCR 120 010 080	12 X R1	22	80	12	
2NCR 060 025 090	6 X R2.5	13	90	6		2NCR 120 010 110	12 X R1	26	110	12	
2NCR 080 001 070	8 X R0.1	16	70	8		2NCR 120 010 130	12 X R1	26	130	12	
2NCR 080 001 100	8 X R0.1	19	100	8		2NCR 120 015 080	12 X R1.5	22	80	12	
2NCR 080 002 070	8 X R0.2	16	70	8		2NCR 120 015 110	12 X R1.5	26	110	12	
2NCR 080 002 100	8 X R0.2	19	100	8		2NCR 120 015 130	12 X R1.5	26	130	12	
2NCR 080 003 070	8 X R0.3	16	70	8		2NCR 120 020 080	12 X R2	22	80	12	
2NCR 080 003 100	8 X R0.3	19	100	8		2NCR 120 020 110	12 X R2	26	110	12	
2NCR 080 005 070	8 X R0.5	16	70	8		2NCR 120 020 130	12 X R2	26	130	12	
2NCR 080 005 100	8 X R0.5	19	100	8		2NCR 120 025 110	12 X R2.5	26	110	12	
2NCR 080 005 120	8 X R0.5	19	120	8		2NCR 120 030 110	12 X R3	26	110	12	
2NCR 080 010 070	8 X R1	16	70	8		2NCR 120 040 110	12 X R4	26	110	12	
2NCR 080 010 100	8 X R1	19	100	8		2NCR 120 050 110	12 X R5	26	110	12	
2NCR 080 010 120	8 X R1	19	120	8		2NCR 140 005 110	14 X R0.5	30	110	14	
2NCR 080 015 070	8 X R1.5	16	70	8		2NCR 140 010 110	14 X R1	30	110	14	
2NCR 080 015 100	8 X R1.5	19	100	8		2NCR 140 020 110	14 X R2	30	110	14	
2NCR 080 020 070	8 X R2	16	70	8		2NCR 160 005 160	16 X R0.5	32	160	16	
2NCR 080 020 100	8 X R2	19	100	8		2NCR 160 010 160	16 X R1	32	160	16	
2NCR 080 025 100	8 X R2.5	19	100	8							
2NCR 080 030 100	8 X R3	19	100	8							
2NCR 080 035 100	8 X R3.5	19	100	8							
2NCR 100 001 075	10 X R0.1	19	75	10							
2NCR 100 001 100	10 X R0.1	22	100	10							
2NCR 100 002 075	10 X R0.2	19	75	10							
2NCR 100 002 100	10 X R0.2	22	100	10							
2NCR 100 003 075	10 X R0.3	19	75	10							
2NCR 100 003 100	10 X R0.3	22	100	10							
2NCR 100 005 075	10 X R0.5	19	75	10							
2NCR 100 005 100	10 X R0.5	22	100	10							
2NCR 100 005 130	10 X R0.5	22	130	10							
2NCR 100 010 075	10 X R1	19	75	10							

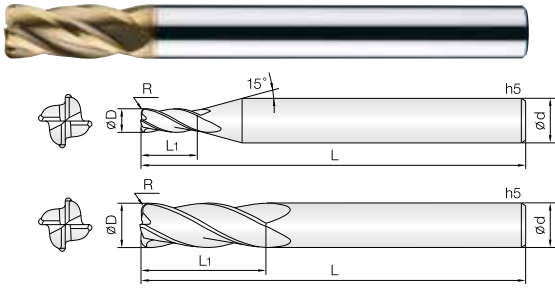

- 고경도강(HRc50~62), 프리하드강 계열의 고속 가공 엔드밀
- 실리콘계 코팅(Si) 처리하여 내마모성이 우수합니다.
- 고정밀 공차 적용으로 초정밀 가공에 적합합니다.
- 코너R 형상을 날부치핑이 적도록 설계하였습니다.
- 다양한 코너R과 유효장으로 맞춤 가공이 가능합니다.
- 초미립자 초경합금(0.2µm)을 채택, 고속절삭시 뛰어난 성능을 발휘합니다.

#### Endmills for pre-hardened and hardened steels(HRc50~62)

- Good wear resistance by Si-based PVD coating.
- High precise edge tolerance.
- Designed for minimizing edge chipping by corner R shape.
- Various corner R and flute length for wide range application.
- Outstanding performance at high speed machining by ultra fine (0.2µm) WC grade.

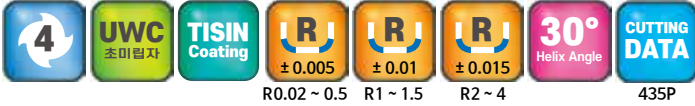

Condition	D Size	D Tolerance	Condition	D Size	D Tolerance
ØD ≠ Ød	Ø0.5 ~ 20	+0 ~ -0.01mm	ØD = Ød	Ø4 ~ 12	-0.005 ~ -0.015mm
				Ø14 ~ 20	-0.01 ~ -0.02mm

단위 : mm

Order Number	날경 Diameter D×R	날장 Length of cut L1	전장 Overall Length L	샙크 Shank Dia d	비고	Order Number	날경 Diameter D×R	날장 Length of cut L1	전장 Overall Length L	샙크 Shank Dia d	비고
4NCR 005 0005 S04	0.5 X R0.05	1	45	4		4NCR 040 002 S06	4 X R0.2	10	70	6	
4NCR 005 001 S04	0.5 X R0.1	1	45	4		4NCR 040 003 060	4 X R0.3	9	60	4	
4NCR 006 001 S04	0.6 X R0.1	1.2	45	4		4NCR 040 003 080	4 X R0.3	9	80	4	
4NCR 006 002 S04	0.6 X R0.2	1.2	45	4		4NCR 040 003 S06	4 X R0.3	10	70	6	
4NCR 008 001 S04	0.8 X R0.1	1.6	45	4		4NCR 040 004 060	4 X R0.4	9	60	4	
4NCR 008 002 S04	0.8 X R0.2	1.6	45	4		4NCR 040 004 080	4 X R0.4	9	80	4	
4NCR 010 0002 S04	1 X R0.02	2.5	45	4		4NCR 040 004 S06	4 X R0.4	10	70	6	
4NCR 010 0005 S04	1 X R0.05	2.5	45	4		4NCR 040 005 060	4 X R0.5	9	60	4	
4NCR 010 001 S04	1 X R0.1	2.5	45	4		4NCR 040 005 080	4 X R0.5	9	80	4	
4NCR 010 002 S04	1 X R0.2	2.5	45	4		4NCR 040 005 S06	4 X R0.5	10	70	6	
4NCR 010 003 S04	1 X R0.3	2.5	45	4		4NCR 040 010 060	4 X R1	9	60	4	
4NCR 012 0002 S04	1.2 X R0.02	4	45	4		4NCR 040 010 080	4 X R1	9	80	4	
4NCR 012 0005 S04	1.2 X R0.05	4	45	4		4NCR 040 010 S06	4 X R1	10	70	6	
4NCR 012 001 S04	1.2 X R0.1	4	45	4		4NCR 050 0005 S06	5 X R0.05	13	75	6	
4NCR 012 002 S04	1.2 X R0.2	4	45	4		4NCR 050 001 S06	5 X R0.1	13	75	6	
4NCR 012 003 S04	1.2 X R0.3	4	45	4		4NCR 050 002 S06	5 X R0.2	13	75	6	
4NCR 015 0002 S04	1.5 X R0.02	4	45	4		4NCR 050 003 S06	5 X R0.3	13	75	6	
4NCR 015 0005 S04	1.5 X R0.05	4	45	4		4NCR 050 004 S06	5 X R0.4	13	75	6	
4NCR 015 001 S04	1.5 X R0.1	4	45	4		4NCR 050 005 S06	5 X R0.5	13	75	6	
4NCR 015 002 S04	1.5 X R0.2	4	45	4		4NCR 050 010 S06	5 X R1	13	75	6	
4NCR 015 003 S04	1.5 X R0.3	4	45	4		4NCR 055 002 S06	5.5 X R0.2	13	75	6	
4NCR 015 004 S04	1.5 X R0.4	4	45	4		4NCR 055 003 S06	5.5 X R0.3	13	75	6	
4NCR 015 005 S04	1.5 X R0.5	4	45	4		4NCR 055 005 S06	5.5 X R0.5	13	75	6	
4NCR 020 0002 S04	2 X R0.02	6	45	4		4NCR 055 010 S06	5.5 X R1	13	75	6	
4NCR 020 0005 S04	2 X R0.05	6	45	4		4NCR 060 0005 080	6 X R0.05	13	80	6	
4NCR 020 001 S04	2 X R0.1	6	45	4		4NCR 060 001 060	6 X R0.1	11	60	6	
4NCR 020 002 S04	2 X R0.2	6	45	4		4NCR 060 001 080	6 X R0.1	13	80	6	
4NCR 020 003 S04	2 X R0.3	6	45	4		4NCR 060 002 060	6 X R0.2	11	60	6	
4NCR 020 004 S04	2 X R0.4	6	45	4		4NCR 060 002 080	6 X R0.2	13	80	6	
4NCR 020 005 S04	2 X R0.5	6	45	4		4NCR 060 003 060	6 X R0.3	11	60	6	
4NCR 025 0005 S04	2.5 X R0.05	6	50	4		4NCR 060 003 080	6 X R0.3	13	80	6	
4NCR 025 001 S04	2.5 X R0.1	6	50	4		4NCR 060 004 080	6 X R0.4	13	80	6	
4NCR 025 002 S04	2.5 X R0.2	6	50	4		4NCR 060 005 060	6 X R0.5	11	60	6	
4NCR 025 003 S04	2.5 X R0.3	6	50	4		4NCR 060 005 080	6 X R0.5	13	80	6	
4NCR 025 005 S04	2.5 X R0.5	6	50	4		4NCR 060 010 060	6 X R1	11	60	6	
4NCR 030 0005 S06	3 X R0.05	8	60	6		4NCR 060 010 080	6 X R1	13	80	6	
4NCR 030 001 S06	3 X R0.1	8	60	6		4NCR 060 015 060	6 X R1.5	11	60	6	
4NCR 030 002 S06	3 X R0.2	8	60	6		4NCR 060 015 080	6 X R1.5	13	80	6	
4NCR 030 003 S06	3 X R0.3	8	60	6		4NCR 060 020 060	6 X R2	11	60	6	
4NCR 030 004 S06	3 X R0.4	8	60	6		4NCR 060 020 080	6 X R2	13	80	6	
4NCR 030 005 S06	3 X R0.5	8	60	6		4NCR 080 001 070	8 X R0.1	16	70	8	
4NCR 030 010 S06	3 X R1	8	60	6		4NCR 080 001 090	8 X R0.1	19	90	8	
4NCR 040 0005 060	4 X R0.05	9	60	4		4NCR 080 002 070	8 X R0.2	16	70	8	
4NCR 040 0005 080	4 X R0.05	9	80	4		4NCR 080 002 090	8 X R0.2	19	90	8	
4NCR 040 0005 S06	4 X R0.05	10	70	6		4NCR 080 003 070	8 X R0.3	16	70	8	
4NCR 040 001 060	4 X R0.1	9	60	4		4NCR 080 003 090	8 X R0.3	19	90	8	
4NCR 040 001 080	4 X R0.1	9	80	4		4NCR 080 005 070	8 X R0.5	16	70	8	
4NCR 040 001 S06	4 X R0.1	10	70	6		4NCR 080 005 090	8 X R0.5	19	90	8	
4NCR 040 002 060	4 X R0.2	9	60	4		4NCR 080 005 110	8 X R0.5	19	110	8	
4NCR 040 002 080	4 X R0.2	9	80	4		4NCR 080 010 070	8 X R1	16	70	8	

단위 : mm

Order Number	날경 Diameter D×R	날장 Length of cut L1	전장 Overall Length L	샙크 Dia d	비고	Order Number	날경 Diameter D×R	날장 Length of cut L1	전장 Overall Length L	샙크 Dia d	비고
4NCR 080 010 090	8 X R1	19	90	8		4NCR 120 025 110	12 X R2.5	26	110	12	
4NCR 080 010 110	8 X R1	19	110	8		4NCR 120 025 130	12 X R2.5	26	130	12	
4NCR 080 015 070	8 X R1.5	16	70	8		4NCR 120 030 080	12 X R3	22	80	12	
4NCR 080 015 090	8 X R1.5	19	90	8		4NCR 120 030 110	12 X R3	26	110	12	
4NCR 080 015 110	8 X R1.5	19	110	8		4NCR 120 030 130	12 X R3	26	130	12	
4NCR 080 020 070	8 X R2	16	70	8		4NCR 120 035 110	12 X R3.5	26	110	12	
4NCR 080 020 090	8 X R2	19	90	8		4NCR 120 040 110	12 X R4	26	110	12	
4NCR 080 020 110	8 X R2	19	110	8		4NCR 140 005 110	14 X R0.5	30	110	14	
4NCR 080 025 090	8 X R2.5	19	90	8		4NCR 140 010 110	14 X R1	30	110	14	
4NCR 100 001 075	10 X R0.1	19	75	10		4NCR 140 020 110	14 X R2	30	110	14	
4NCR 100 001 100	10 X R0.1	22	100	10		4NCR 160 005 110	16 X R0.5	32	110	16	
4NCR 100 002 075	10 X R0.2	19	75	10		4NCR 160 005 160	16 X R0.5	32	160	16	
4NCR 100 002 100	10 X R0.2	22	100	10		4NCR 160 010 110	16 X R1	32	110	16	
4NCR 100 002 120	10 X R0.2	22	120	10		4NCR 160 010 160	16 X R1	32	160	16	
4NCR 100 003 075	10 X R0.3	19	75	10		4NCR 160 015 110	16 X R1.5	32	110	16	
4NCR 100 003 100	10 X R0.3	22	100	10		4NCR 160 020 110	16 X R2	32	110	16	
4NCR 100 005 075	10 X R0.5	19	75	10		4NCR 160 030 110	16 X R3	32	110	16	
4NCR 100 005 100	10 X R0.5	22	100	10		4NCR 200 005 160	20 X R0.5	38	160	20	
4NCR 100 005 120	10 X R0.5	22	120	10		4NCR 200 010 160	20 X R1	38	160	20	
4NCR 100 010 075	10 X R1	19	75	10		4NCR 200 015 160	20 X R1.5	38	160	20	
4NCR 100 010 100	10 X R1	22	100	10		4NCR 200 020 160	20 X R2	38	160	20	
4NCR 100 010 120	10 X R1	22	120	10							
4NCR 100 015 075	10 X R1.5	19	75	10							
4NCR 100 015 100	10 X R1.5	22	100	10							
4NCR 100 015 120	10 X R1.5	22	120	10							
4NCR 100 020 075	10 X R2	19	75	10							
4NCR 100 020 100	10 X R2	22	100	10							
4NCR 100 020 120	10 X R2	22	120	10							
4NCR 100 025 075	10 X R2.5	19	75	10							
4NCR 100 025 100	10 X R2.5	22	100	10							
4NCR 100 025 120	10 X R2.5	22	120	10							
4NCR 100 030 100	10 X R3	22	100	10							
4NCR 120 002 080	12 X R0.2	22	80	12							
4NCR 120 002 110	12 X R0.2	26	110	12							
4NCR 120 002 130	12 X R0.2	26	130	12							
4NCR 120 003 080	12 X R0.3	22	80	12							
4NCR 120 003 110	12 X R0.3	26	110	12							
4NCR 120 005 080	12 X R0.5	22	80	12							
4NCR 120 005 110	12 X R0.5	26	110	12							
4NCR 120 005 130	12 X R0.5	26	130	12							
4NCR 120 010 080	12 X R1	22	80	12							
4NCR 120 010 110	12 X R1	26	110	12							
4NCR 120 010 130	12 X R1	26	130	12							
4NCR 120 015 080	12 X R1.5	22	80	12							
4NCR 120 015 110	12 X R1.5	26	110	12							
4NCR 120 015 130	12 X R1.5	26	130	12							
4NCR 120 020 080	12 X R2	22	80	12							
4NCR 120 020 110	12 X R2	26	110	12							
4NCR 120 020 130	12 X R2	26	130	12							
4NCR 120 025 080	12 X R2.5	22	80	12							

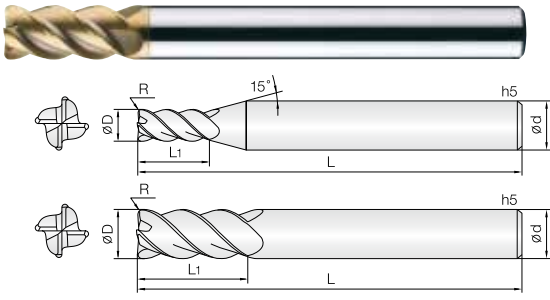

- 고경도강(HRC50~62), 프리하든강 계열의 고정밀 가공 엔드밀
- 실리콘계 코팅(Si) 처리하여 내마모성이 우수합니다.
- 고정밀 공차 적용으로 초정밀 가공에 적합합니다.
- 코너R 형상을 날부치핑이 적도록 설계하였습니다.
- 45° 헬릭스 형상으로 설계하여 고속, 고이송 가공에 적합합니다.
- 초미립자 초경합금(0.2 $\mu$ m)을 채택, 고속절삭시 뛰어난 성능을 발휘합니다.
- Endmills for pre-hardened and hardened steels(HRC50~62)
- Good wear resistance by Si-based PVD coating.
- High precise edge tolerance.
- Designed for minimizing edge chipping by corner R shape.
- 45° degree helix design for high speed, feed condition.
- Outstanding performance at high speed machining by ultra fine (0.2 $\mu$ m) WC grade.

4

UWC  
초미립자

TISIN  
Coating

R  
± 0.005

R  
± 0.01

R  
± 0.015

45°  
Helix Angle

CUTTING  
DATA

R0.05 ~ 0.5    R1 ~ 1.5    R2 ~ 5    436P

Condition	D Size	D Tolerance	Condition	D Size	D Tolerance
$\varnothing D \neq \varnothing d$	$\varnothing 1 \sim 20$	+0 ~ -0.01mm	$\varnothing D = \varnothing d$	$\varnothing 6 \sim 12$	-0.005 ~ -0.015mm
				$\varnothing 16 \sim 20$	-0.01 ~ -0.02mm

단위 : mm

Order Number	날경 Diameter D × R	날장 Length of cut L1	전장 Overall Length L	샙크 Shank Dia d	비고	Order Number	날경 Diameter D × R	날장 Length of cut L1	전장 Overall Length L	샙크 Shank Dia d	비고
4CRL 010 0005 S06	1 X R0.05	2	50	6		4CRL 100 003 S10	10 X R0.3	20	100	10	
4CRL 010 001 S06	1 X R0.1	2	50	6		4CRL 100 005 S10	10 X R0.5	20	100	10	
4CRL 010 002 S06	1 X R0.2	2	50	6		4CRL 100 010 S10	10 X R1	20	100	10	
4CRL 010 003 S06	1 X R0.3	2	50	6		4CRL 100 015 S10	10 X R1.5	20	100	10	
4CRL 012 0005 S06	1.2 X R0.05	2.5	50	6		4CRL 100 020 S10	10 X R2	20	100	10	
4CRL 012 001 S06	1.2 X R0.1	2.5	50	6		4CRL 120 003 S12	12 X R0.3	24	110	12	
4CRL 012 002 S06	1.2 X R0.2	2.5	50	6		4CRL 120 005 S12	12 X R0.5	24	110	12	
4CRL 012 003 S06	1.2 X R0.3	2.5	50	6		4CRL 120 010 S12	12 X R1	24	110	12	
4CRL 015 0005 S06	1.5 X R0.05	3	50	6		4CRL 120 015 S12	12 X R1.5	24	110	12	
4CRL 015 001 S06	1.5 X R0.1	3	50	6		4CRL 120 020 S12	12 X R2	24	110	12	
4CRL 015 002 S06	1.5 X R0.2	3	50	6		4CRL 120 030 S12	12 X R3	24	110	12	
4CRL 015 003 S06	1.5 X R0.3	3	50	6		4CRL 160 005 S16	16 X R0.5	32	120	16	
4CRL 015 005 S06	1.5 X R0.5	3	50	6		4CRL 160 010 S16	16 X R1	32	120	16	
4CRL 020 001 S06	2 X R0.1	5	50	6		4CRL 160 020 S16	16 X R2	32	120	16	
4CRL 020 002 S06	2 X R0.2	5	50	6		4CRL 160 030 S16	16 X R3	32	120	16	
4CRL 020 003 S06	2 X R0.3	5	50	6		4CRL 200 005 S20	20 X R0.5	38	130	20	
4CRL 020 005 S06	2 X R0.5	5	50	6		4CRL 200 010 S20	20 X R1	38	130	20	
4CRL 025 001 S06	2.5 X R0.1	6	60	6		4CRL 200 020 S20	20 X R2	38	130	20	
4CRL 025 002 S06	2.5 X R0.2	6	60	6		4CRL 200 030 S20	20 X R3	38	130	20	
4CRL 025 003 S06	2.5 X R0.3	6	60	6		4CRL 200 040 S20	20 X R4	38	130	20	
4CRL 025 005 S06	2.5 X R0.5	6	60	6		4CRL 200 050 S20	20 X R5	38	130	20	
4CRL 030 001 S06	3 X R0.1	6	70	6							
4CRL 030 002 S06	3 X R0.2	6	70	6							
4CRL 030 003 S06	3 X R0.3	6	70	6							
4CRL 030 005 S06	3 X R0.5	6	70	6							
4CRL 030 010 S06	3 X R1	6	70	6							
4CRL 040 001 S06	4 X R0.1	8	70	6							
4CRL 040 002 S06	4 X R0.2	8	70	6							
4CRL 040 003 S06	4 X R0.3	8	70	6							
4CRL 040 005 S06	4 X R0.5	8	70	6							
4CRL 040 010 S06	4 X R1	8	70	6							
4CRL 050 001 S06	5 X R0.1	10	80	6							
4CRL 050 002 S06	5 X R0.2	10	80	6							
4CRL 050 003 S06	5 X R0.3	10	80	6							
4CRL 050 005 S06	5 X R0.5	10	80	6							
4CRL 050 010 S06	5 X R1	10	80	6							
4CRL 060 001 S06	6 X R0.1	12	90	6							
4CRL 060 002 S06	6 X R0.2	12	90	6							
4CRL 060 003 S06	6 X R0.3	12	90	6							
4CRL 060 005 S06	6 X R0.5	12	90	6							
4CRL 060 010 S06	6 X R1	12	90	6							
4CRL 060 015 S06	6 X R1.5	12	90	6							
4CRL 060 020 S06	6 X R2	12	90	6							
4CRL 080 002 S08	8 X R0.2	16	90	8							
4CRL 080 003 S08	8 X R0.3	16	90	8							
4CRL 080 005 S08	8 X R0.5	16	90	8							
4CRL 080 010 S08	8 X R1	16	90	8							
4CRL 080 015 S08	8 X R1.5	16	90	8							
4CRL 080 020 S08	8 X R2	16	90	8							
4CRL 100 002 S10	10 X R0.2	20	100	10							



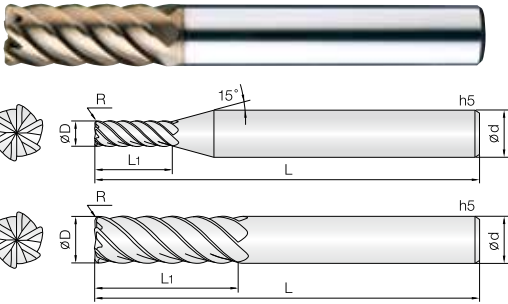

- 고경도강(HRc50~62), 프리하든강 계열의 고정밀 가공 엔드밀
- 실리콘계 코팅(Si) 처리하여 내마모성이 우수합니다.
- 45° 헬릭스 형상으로 설계하여 고속, 고이송 가공에 적합합니다.
- 측벽가공, 코너부, 무구배면 가공시 가공물의 표면조도가 뛰어나며, 인선날 길이 증가로 내마모성이 더욱 좋아집니다.
- 초미립자 초경합금(0.2 $\mu$ m)을 채택, 고속절삭시 뛰어난 성능을 발휘합니다.

#### • Endmills for pre-hardened and hardened steels(HRc50~62)

- Good wear resistance by Si-based PVD coating.
- 45° degree helix design for high speed, feed condition.
- Improved wear resistance with longer edge and excellent work surface finish in various machining applications.
- Outstanding performance at high speed machining by ultra fine (0.2 $\mu$ m) WC grade.

6

UWC  
초미립자

TISIN  
Coating

R

R

R

45°  
Helix Angle

CUTTING  
DATA

R0.1 ~ 0.5   R1 ~ 1.5   R2   436P

Condition	D Size	D Tolerance	Condition	D Size	D Tolerance
$\varnothing D \neq \varnothing d$	$\varnothing 3 \sim 16$	+0 ~ -0.01mm	$\varnothing D = \varnothing d$	$\varnothing 6 \sim 12$	-0.005 ~ -0.015mm
				$\varnothing 16$	-0.01 ~ -0.02mm

단위 : mm

Order Number	날경 Diameter D × R	날장 Length of cut L1	전장 Overall Length L	생크 Shank Dia d	비고	Order Number	날경 Diameter D × R	날장 Length of cut L1	전장 Overall Length L	생크 Shank Dia d	비고
6CRL 030 001 060	3 X R0.1	7.5	60	6							
6CRL 030 002 060	3 X R0.2	7.5	60	6							
6CRL 030 003 060	3 X R0.3	7.5	60	6							
6CRL 030 005 060	3 X R0.5	7.5	60	6							
6CRL 030 010 060	3 X R1	7.5	60	6							
6CRL 040 001 060	4 X R0.1	10	60	6							
6CRL 040 002 060	4 X R0.2	10	60	6							
6CRL 040 003 060	4 X R0.3	10	60	6							
6CRL 040 005 060	4 X R0.5	10	60	6							
6CRL 040 010 060	4 X R1	10	60	6							
6CRL 050 002 060	5 X R0.2	13	60	6							
6CRL 050 003 060	5 X R0.3	13	60	6							
6CRL 050 005 060	5 X R0.5	13	60	6							
6CRL 050 010 060	5 X R1	13	60	6							
6CRL 060 001 060	6 X R0.1	15	60	6							
6CRL 060 002 060	6 X R0.2	15	60	6							
6CRL 060 002 080	6 X R0.2	15	80	6							
6CRL 060 003 060	6 X R0.3	15	60	6							
6CRL 060 003 080	6 X R0.3	15	80	6							
6CRL 060 005 060	6 X R0.5	15	60	6							
6CRL 060 005 080	6 X R0.5	15	80	6							
6CRL 060 010 060	6 X R1	15	60	6							
6CRL 060 010 080	6 X R1	15	80	6							
6CRL 080 002 070	8 X R0.2	20	70	8							
6CRL 080 003 070	8 X R0.3	20	70	8							
6CRL 080 003 090	8 X R0.3	20	90	8							
6CRL 080 005 070	8 X R0.5	20	70	8							
6CRL 080 005 090	8 X R0.5	20	90	8							
6CRL 080 010 070	8 X R1	20	70	8							
6CRL 080 010 090	8 X R1	20	90	8							
6CRL 080 015 070	8 X R1.5	20	70	8							
6CRL 100 002 075	10 X R0.2	20	75	10							
6CRL 100 003 075	10 X R0.3	25	75	10							
6CRL 100 003 100	10 X R0.3	25	100	10							
6CRL 100 005 075	10 X R0.5	25	75	10							
6CRL 100 005 100	10 X R0.5	25	100	10							
6CRL 100 010 075	10 X R1	25	75	10							
6CRL 100 010 100	10 X R1	25	100	10							
6CRL 100 020 075	10 X R2	25	75	10							
6CRL 120 002 080	12 X R0.2	25	80	12							
6CRL 120 003 080	12 X R0.3	30	80	12							
6CRL 120 003 110	12 X R0.3	30	110	12							
6CRL 120 005 080	12 X R0.5	30	80	12							
6CRL 120 005 110	12 X R0.5	30	110	12							
6CRL 120 010 080	12 X R1	30	80	12							
6CRL 120 010 110	12 X R1	30	110	12							
6CRL 120 020 080	12 X R2	30	80	12							
6CRL 160 005 110	16 X R0.5	50	110	16							
6CRL 160 010 110	16 X R1	50	110	16							
6CRL 160 020 110	16 X R2	50	110	16							

# 4RCU 4 Flutes High Speed Corner Radius Cutters

## 4날 고이송 코너 레디우스 커터

HARD series

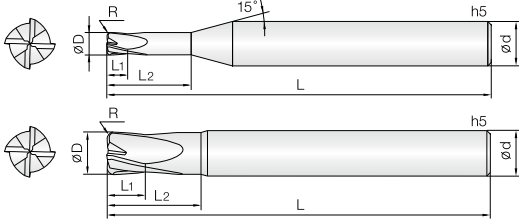

- 고경도강(HRc50~62), 프리하드강 계열의 고정밀 가공 엔드밀
- 실리콘계 코팅(Si) 처리하여 내마모성이 우수합니다.
- 저속 RPM에서 고이송 작업이 가능하도록 설계하였습니다.
- 중삭 및 황삭 가공시 작업 효율이 극대화 됩니다.
- 항절력이 높은 미립자 초경합금을 채택하여, 고이송 작업시 엔드밀의 파손을 최소화 하였습니다.

### • Endmills for pre-hardened and hardened steels(HRc50~62)

- Good wear resistance by Si-based PVD coating.
- Designed for low speed with high feed condition.
- Suitable for heavy duty and roughing application.
- Minimize fracturing at high feed by high TRS fine WC grade.

4

WC  
미립자

TISIN  
Coating

R

R

R

15°  
Helix Angle

CUTTING  
DATA

R0.2 ~ 0.5    R1 ~ 1.5    R2 ~ 3    437P

Condition	D Size	D Tolerance	Condition	D Size	D Tolerance
øD ≠ ød	ø1 ~ 16	+0 ~ -0.01mm	øD = ød	ø6 ~ 12	-0.005 ~ -0.015mm
				ø16	-0.01 ~ -0.02mm

단위 : mm

Order Number	날경 Diameter D × R	날장 Length of cut L1	유효장 Effective Length L2	전장 Overall Length L	샙크 Shank Dia d	비고	Order Number	날경 Diameter D × R	날장 Length of cut L1	유효장 Effective Length L2	전장 Overall Length L	샙크 Shank Dia d	비고
4RCU 010 002 025	1 X R0.2	1	2.5	50	4		4RCU 120 020 350	12 X R2	12	35	130	12	
4RCU 015 005 040	1.5 X R0.5	1.5	4	50	4		4RCU 120 030 250	12 X R3	12	25	80	12	
4RCU 020 005 060	2 X R0.5	2	6	50	6		New 4RCU 120 030 300	12 X R3	12	30	100	12	
4RCU 030 005 080	3 X R0.5	3	8	50	6		New 4RCU 120 030 350	12 X R3	12	35	130	12	
4RCU 040 005 120	4 X R0.5	4	12	60	6		New 4RCU 120 040 250	12 X R4	12	25	80	12	
4RCU 040 005 160	4 X R0.5	4	16	60	6		New 4RCU 120 040 300	12 X R4	12	30	100	12	
4RCU 040 010 120	4 X R1	4	12	60	6		New 4RCU 120 040 350	12 X R4	12	35	130	12	
4RCU 040 010 160	4 X R1	4	16	60	6		4RCU 160 010 300	16 X R1	16	30	110	16	
4RCU 050 005 150	5 X R0.5	5	15	60	6		4RCU 160 010 400	16 X R1	16	40	160	16	
4RCU 050 010 150	5 X R1	5	15	60	6		4RCU 160 020 300	16 X R2	16	30	110	16	
4RCU 060 003 150	6 X R0.3	6	15	60	6		4RCU 160 020 400	16 X R2	16	40	160	16	
4RCU 060 005 150	6 X R0.5	6	15	60	6		New 4RCU 160 030 300	16 X R3	16	30	110	16	
4RCU 060 010 150	6 X R1	6	15	60	6		New 4RCU 160 030 400	16 X R3	16	40	160	16	
4RCU 060 015 150	6 X R1.5	6	15	60	6		New 4RCU 160 040 300	16 X R4	16	30	110	16	
New 4RCU 060 020 150	6 X R2	6	15	60	6		New 4RCU 160 040 400	16 X R4	16	40	160	16	
New 4RCU 060 025 150	6 X R2.5	6	15	60	6		New 4RCU 160 050 300	16 X R5	16	30	110	16	
4RCU 080 003 160	8 X R0.3	8	16	60	8		New 4RCU 160 050 400	16 X R5	16	40	160	16	
4RCU 080 005 160	8 X R0.5	8	16	60	8								
4RCU 080 005 200	8 X R0.5	8	20	80	8								
4RCU 080 005 300	8 X R0.5	8	30	110	8								
4RCU 080 010 160	8 X R1	8	16	60	8								
4RCU 080 010 200	8 X R1	8	20	80	8								
4RCU 080 010 300	8 X R1	8	30	110	8								
4RCU 080 020 160	8 X R2	8	16	60	8								
4RCU 080 020 200	8 X R2	8	20	80	8								
4RCU 080 020 300	8 X R2	8	30	110	8								
New 4RCU 080 030 160	8 X R3	8	16	60	8								
New 4RCU 080 030 200	8 X R3	8	20	80	8								
New 4RCU 080 030 300	8 X R3	8	30	110	8								
4RCU 100 003 200	10 X R0.3	10	20	70	10								
4RCU 100 005 200	10 X R0.5	10	20	70	10								
4RCU 100 005 250	10 X R0.5	10	25	90	10								
4RCU 100 005 300	10 X R0.5	10	30	120	10								
4RCU 100 010 200	10 X R1	10	20	70	10								
4RCU 100 010 250	10 X R1	10	25	90	10								
4RCU 100 010 300	10 X R1	10	30	120	10								
4RCU 100 020 200	10 X R2	10	20	70	10								
4RCU 100 020 250	10 X R2	10	25	90	10								
4RCU 100 020 300	10 X R2	10	30	120	10								
New 4RCU 100 030 200	10 X R3	10	20	70	10								
New 4RCU 100 030 250	10 X R3	10	25	90	10								
New 4RCU 100 030 300	10 X R3	10	30	120	10								
4RCU 120 005 250	12 X R0.5	12	25	80	12								
4RCU 120 005 300	12 X R0.5	12	30	100	12								
4RCU 120 005 350	12 X R0.5	12	35	130	12								
4RCU 120 010 250	12 X R1	12	25	80	12								
4RCU 120 010 300	12 X R1	12	30	100	12								
4RCU 120 010 350	12 X R1	12	35	130	12								
4RCU 120 020 250	12 X R2	12	25	80	12								
4RCU 120 020 300	12 X R2	12	30	100	12								

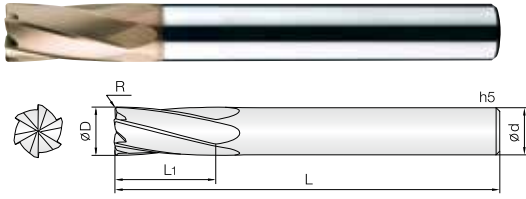

- 고경도강(HRc50~62), 프리하든강 계열의 고정밀 가공 엔드밀
- 실리콘계 코팅(Si) 처리하여 내마모성이 우수합니다.
- 저속 RPM에서 고이송 작업이 가능하도록 설계하였습니다.
- 중삭 및 황삭 가공시 작업 효율이 극대화 됩니다.
- 항절력이 높은 미립자 초경합금을 채택하여, 고이송 작업시 엔드밀의 파손을 최소화 하였습니다.

#### • Endmills for pre-hardened and hardened steels(HRc50~62)

- Good wear resistance by Si-based PVD coating.
- Designed for low speed with high feed condition.
- Suitable for heavy duty and roughing application.
- Minimize fracturing at high feed by high TRS fine WC grade.

6

WC  
미립자

TISIN  
Coating

R  
± 0.005

R  
± 0.01

R  
± 0.015

15°  
Helix Angle

CUTTING  
DATA

Condition	D Size	D Tolerance	Condition	D Size	D Tolerance
ØD ≠ Ød	Ø6 ~ 20	+0 ~ -0.01mm	ØD = Ød	Ø6 ~ 12	-0.005 ~ -0.015mm
				Ø16 ~ 20	-0.01 ~ -0.02mm

단위 : mm

Order Number	날경 Diameter D × R	날장 Length of cut L1	전장 Overall Length L	생크 Shank Dia d	비고	Order Number	날경 Diameter D	날장 Length of cut L1	전장 Overall Length L	생크 Shank Dia d	비고
6RCU 060 005 060	6 X R0.5	12	60	6							
6RCU 060 005 080	6 X R0.5	12	80	6							
6RCU 060 010 060	6 X R1	12	60	6							
6RCU 060 010 080	6 X R1	12	80	6							
6RCU 080 005 060	8 X R0.5	16	60	8							
6RCU 080 005 090	8 X R0.5	16	90	8							
6RCU 080 010 060	8 X R1	16	60	8							
6RCU 080 010 090	8 X R1	16	90	8							
6RCU 080 020 060	8 X R2	16	60	8							
6RCU 080 020 090	8 X R2	16	90	8							
6RCU 100 005 070	10 X R0.5	20	70	10							
6RCU 100 005 100	10 X R0.5	20	100	10							
6RCU 100 010 070	10 X R1	20	70	10							
6RCU 100 010 100	10 X R1	20	100	10							
6RCU 100 020 070	10 X R2	20	70	10							
6RCU 100 020 100	10 X R2	20	100	10							
6RCU 120 005 080	12 X R0.5	25	80	12							
6RCU 120 005 110	12 X R0.5	25	110	12							
6RCU 120 010 080	12 X R1	25	80	12							
6RCU 120 010 110	12 X R1	25	110	12							
6RCU 120 020 080	12 X R2	25	80	12							
6RCU 120 020 110	12 X R2	25	110	12							
6RCU 160 005 160	16 X R0.5	35	160	16							
6RCU 160 005 200	16 X R0.5	35	200	16							
6RCU 160 010 160	16 X R1	35	160	16							
6RCU 160 010 200	16 X R1	35	200	16							
6RCU 160 015 160	16 X R1.5	35	160	16							
6RCU 160 015 200	16 X R1.5	35	200	16							
6RCU 160 020 160	16 X R2	35	160	16							
6RCU 160 020 200	16 X R2	35	200	16							
6RCU 200 005 150	20 X R0.5	40	150	20							
6RCU 200 005 200	20 X R0.5	40	200	20							
6RCU 200 010 150	20 X R1	40	150	20							
6RCU 200 010 200	20 X R1	40	200	20							
6RCU 200 015 150	20 X R1.5	40	150	20							
6RCU 200 015 200	20 X R1.5	40	200	20							
6RCU 200 020 150	20 X R2	40	150	20							
6RCU 200 020 200	20 X R2	40	200	20							

# 3&4ROU 3&4 Flutes Roughing End Mills

## 3&4날 라핑 엔드밀

HARD series

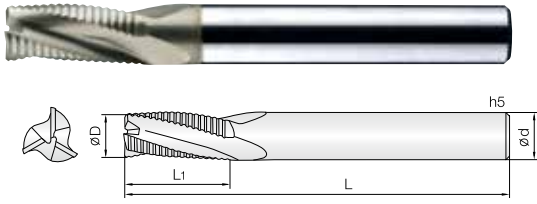

- 공구강, 합금강 및 고경도 일반강 황삭가공 엔드밀
- JCRO 코팅 처리하여 다양한 피삭재 가공시 인선부에 스트레스가 적으며, 내마모성 또한 향상됩니다.
- 뛰어난 칩배출력으로 가공시간을 단축하였습니다.
- 항질력이 높은 미립자 초경합금을 채택하여, 고이송 작업시 엔드밀의 파손을 최소화하였습니다.

- **Roughing Endmills for tool steels, alloy steels**
- JCRO coating provides wear resistance improvement as well as avoid edge stress in various applications.
- Reduce machining time by excellent chip control.
- Minimize fracturing at high feed by high TRS fine WC grade.



D Size	D Tolerance
ø4 ~ 9	-0.02 ~ -0.04mm
ø10 ~ 20	-0.02 ~ -0.05mm

단위 : mm

Order Number	날경 Diameter D	날장 Length of cut L1	전장 Overall Length L	생크 Shank Dia d	비고	Order Number	날경 Diameter D	날장 Length of cut L1	전장 Overall Length L	생크 Shank Dia d	비고
3ROU 040 100 S06	4	10	50	6							
3ROU 050 130 S06	5	13	50	6							
3ROU 060 100 050	6	10	50	6							
3ROU 060 150 055	6	15	55	6							
3ROU 060 200 060	6	20	60	6							
3ROU 070 180 S08	7	18	65	8							
3ROU 080 120 060	8	12	60	8							
3ROU 080 190 065	8	19	65	8							
3ROU 080 250 070	8	25	70	8							
4ROU 090 220 S10	9	22	70	10							
4ROU 100 150 070	10	15	70	10							
4ROU 100 220 070	10	22	70	10							
4ROU 100 300 080	10	30	80	10							
4ROU 110 270 S12	11	27	80	12							
4ROU 120 200 075	12	20	75	12							
4ROU 120 260 080	12	26	80	12							
4ROU 120 350 090	12	35	90	12							
4ROU 160 320 090	16	32	90	16							
4ROU 160 400 100	16	40	100	16							
4ROU 200 380 110	20	38	110	20							
4ROU 200 500 110	20	50	110	20							

### 3&4날 45° 헬릭스 파인피치형 라핑 엔드밀

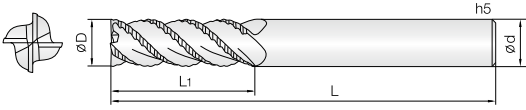

- 합금강, SUS계열, 인코넬, 일반구조강 등 다양한 난삭재의 황삭가공
- JCRO 코팅 처리하여 다양한 피삭재 가공시 인선부에 스트레스가 적으며, 내마모성 또한 향상됩니다.
- 45° 헬릭스 적용으로 절삭 저항이 감소되어 장시간 가공에 적합합니다.
- 파인피치 형상 채택으로 고속, 황삭가공 작업에 적합합니다.

#### • Roughing Endmills for hard to cut materials, alloy steels, SUS, Inconel and structural steels.

- JCRO coating provides wear resistance improvement as well as avoid edge stress in various applications.
- Long tool life with low cutting force by 45° degree helix design.
- Fine pitch shape design for high speed roughing application.



Shield Edge 439P

Condition	D Size	D Tolerance	Condition	D Size	D Tolerance
ØD ≠ Ød	Ø4 ~ 6	+0 ~ -0.01mm	ØD = Ød	Ø6	-0.005 ~ -0.015mm
	Ø7 ~ 20	+0 ~ -0.015mm		Ø8 ~ 12	-0.01 ~ -0.025mm
		Ø16 ~ 20		-0.015 ~ -0.03mm	

단위 : mm

Order Number	날경 Diameter D	날장 Length of cut L1	전장 Overall Length L	생크 Shank Dia d	비고
3HROU 040 100 S06	4	10	50	6	
3HROU 050 130 S06	5	13	50	6	
3HROU 060 100 050	6	10	50	6	
3HROU 060 160 055	6	16	55	6	
3HROU 060 200 060	6	20	60	6	
3HROU 070 180 S08	7	18	65	8	
3HROU 080 120 060	8	12	60	8	
3HROU 080 190 065	8	19	65	8	
3HROU 080 250 070	8	25	70	8	
3HROU 080 300 075	8	30	75	8	
4HROU 090 220 S10	9	22	70	10	
4HROU 100 150 070	10	15	70	10	
4HROU 100 220 070	10	22	70	10	
4HROU 100 300 080	10	30	80	10	
4HROU 100 400 090	10	40	90	10	
4HROU 110 270 S12	11	27	80	12	
4HROU 120 200 075	12	20	75	12	
4HROU 120 250 080	12	25	80	12	
4HROU 120 350 090	12	35	90	12	
4HROU 120 500 100	12	50	100	12	
4HROU 160 320 090	16	32	90	16	
4HROU 160 400 110	16	40	110	16	
4HROU 200 380 110	20	38	110	20	
4HROU 200 500 120	20	50	120	20	

Order Number	날경 Diameter D	날장 Length of cut L1	전장 Overall Length L	생크 Shank Dia d	비고

HARD series

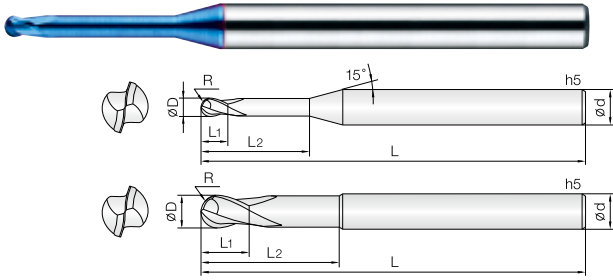

- 중저경도강(HRC52이하), 프리하든강 계열, 탄소강, 금형강등 다양한 피삭재 가공 엔드밀
- 고품질 실리콘계 코팅(Si)처리하여 내마모성이 우수합니다.
- 넓은 영역의 피삭재 가공에 적합한 형상으로 설계 하였습니다.
- 항절력이 높은 미립자 초경합금(0.5µm)을 채택, 엔드밀의 파손을 최소화 하였습니다.

#### Endmills for various work materials (~HRC52), pre-hardened steels, carbon steels, mold steels

- Good wear resistance by high quality Si-based PVD coating.
- Suitable shape is designed for tooling in wide areas.
- Minimize fracturing by high TRS fine(0.5µm) WC grade.

E series



0.1 ~ 2.5R    3 ~ 6R    440P

Condition	D Size	D Tolerance	Condition	D Size	D Tolerance
ØD ≠ Ød	Ø0.2 ~ 12	+0 ~ -0.01mm	ØD = Ød	Ø6 ~ 12	-0.005 ~ -0.015mm

단위 : mm

Order Number	날경 Diameter R × D	날장 Length of cut L1	유효장 Effective Length L2	전장 Overall Length L	샙크 Dia d	비고
2HRBE 002 005 S04	0.1R X 0.2	0.2	0.5	40	4	
2HRBE 002 010 S04	0.1R X 0.2	0.2	1	40	4	
2HRBE 002 015 S04	0.1R X 0.2	0.2	1.5	40	4	
2HRBE 002 020 S04	0.1R X 0.2	0.2	2	40	4	
2HRBE 003 010 S04	0.15R X 0.3	0.3	1	40	4	
2HRBE 003 015 S04	0.15R X 0.3	0.3	1.5	40	4	
2HRBE 003 020 S04	0.15R X 0.3	0.3	2	40	4	
2HRBE 003 030 S04	0.15R X 0.3	0.3	3	40	4	
2HRBE 003 040 S04	0.15R X 0.3	0.3	4	40	4	
2HRBE 004 010 S04	0.2R X 0.4	0.4	1	40	4	
2HRBE 004 020 S04	0.2R X 0.4	0.4	2	40	4	
2HRBE 004 030 S04	0.2R X 0.4	0.4	3	40	4	
2HRBE 004 040 S04	0.2R X 0.4	0.4	4	40	4	
2HRBE 004 050 S04	0.2R X 0.4	0.4	5	40	4	
2HRBE 004 060 S04	0.2R X 0.4	0.4	6	40	4	
2HRBE 004 080 S04	0.2R X 0.4	0.4	8	40	4	
2HRBE 005 010 S04	0.25R X 0.5	0.5	1	45	4	
2HRBE 005 020 S04	0.25R X 0.5	0.5	2	45	4	
2HRBE 005 030 S04	0.25R X 0.5	0.5	3	45	4	
2HRBE 005 040 S04	0.25R X 0.5	0.5	4	45	4	
2HRBE 005 050 S04	0.25R X 0.5	0.5	5	45	4	
2HRBE 005 060 S04	0.25R X 0.5	0.5	6	45	4	
2HRBE 005 080 S04	0.25R X 0.5	0.5	8	45	4	
2HRBE 005 100 S04	0.25R X 0.5	0.5	10	45	4	
2HRBE 005 120 S04	0.25R X 0.5	0.5	12	45	4	
2HRBE 006 010 S04	0.3R X 0.6	0.6	1	45	4	
2HRBE 006 020 S04	0.3R X 0.6	0.6	2	45	4	
2HRBE 006 030 S04	0.3R X 0.6	0.6	3	45	4	
2HRBE 006 040 S04	0.3R X 0.6	0.6	4	45	4	
2HRBE 006 050 S04	0.3R X 0.6	0.6	5	45	4	
2HRBE 006 060 S04	0.3R X 0.6	0.6	6	45	4	
2HRBE 006 080 S04	0.3R X 0.6	0.6	8	45	4	
2HRBE 006 100 S04	0.3R X 0.6	0.6	10	45	4	
2HRBE 006 120 S04	0.3R X 0.6	0.6	12	45	4	
2HRBE 006 140 S04	0.3R X 0.6	0.6	14	45	4	
2HRBE 007 020 S04	0.35R X 0.7	0.7	2	45	4	
2HRBE 007 040 S04	0.35R X 0.7	0.7	4	45	4	
2HRBE 007 060 S04	0.35R X 0.7	0.7	6	45	4	
2HRBE 007 080 S04	0.35R X 0.7	0.7	8	45	4	
2HRBE 007 100 S04	0.35R X 0.7	0.7	10	45	4	
2HRBE 007 120 S04	0.35R X 0.7	0.7	12	45	4	
2HRBE 008 020 S04	0.4R X 0.8	0.8	2	45	4	
2HRBE 008 030 S04	0.4R X 0.8	0.8	3	45	4	
2HRBE 008 040 S04	0.4R X 0.8	0.8	4	45	4	
2HRBE 008 050 S04	0.4R X 0.8	0.8	5	45	4	
2HRBE 008 060 S04	0.4R X 0.8	0.8	6	45	4	
2HRBE 008 080 S04	0.4R X 0.8	0.8	8	45	4	
2HRBE 008 100 S04	0.4R X 0.8	0.8	10	45	4	
2HRBE 008 120 S04	0.4R X 0.8	0.8	12	45	4	
2HRBE 009 040 S04	0.45R X 0.9	0.9	4	45	4	

Order Number	날경 Diameter R × D	날장 Length of cut L1	유효장 Effective Length L2	전장 Overall Length L	샙크 Dia d	비고
2HRBE 009 060 S04	0.45R X 0.9	0.9	6	45	4	
2HRBE 009 080 S04	0.45R X 0.9	0.9	8	45	4	
2HRBE 009 100 S04	0.45R X 0.9	0.9	10	50	4	
2HRBE 010 020 S04	0.5R X 1	1	2	45	4	
2HRBE 010 030 S04	0.5R X 1	1	3	45	4	
2HRBE 010 040 S04	0.5R X 1	1	4	45	4	
2HRBE 010 050 S04	0.5R X 1	1	5	45	4	
2HRBE 010 060 S04	0.5R X 1	1	6	45	4	
2HRBE 010 080 S04	0.5R X 1	1	8	45	4	
2HRBE 010 100 S04	0.5R X 1	1	10	50	4	
2HRBE 010 120 S04	0.5R X 1	1	12	50	4	
2HRBE 010 140 S04	0.5R X 1	1	14	50	4	
2HRBE 010 160 S04	0.5R X 1	1	16	50	4	
2HRBE 010 180 S04	0.5R X 1	1	18	50	4	
2HRBE 010 200 S04	0.5R X 1	1	20	50	4	
2HRBE 010 220 S04	0.5R X 1	1	22	60	4	
2HRBE 010 250 S04	0.5R X 1	1	25	60	4	
2HRBE 012 040 S04	0.6R X 1.2	1.2	4	45	4	
2HRBE 012 060 S04	0.6R X 1.2	1.2	6	45	4	
2HRBE 012 080 S04	0.6R X 1.2	1.2	8	45	4	
2HRBE 012 100 S04	0.6R X 1.2	1.2	10	50	4	
2HRBE 012 120 S04	0.6R X 1.2	1.2	12	50	4	
2HRBE 012 160 S04	0.6R X 1.2	1.2	16	50	4	
2HRBE 012 200 S04	0.6R X 1.2	1.2	20	50	4	
2HRBE 012 240 S04	0.6R X 1.2	1.2	24	60	4	
2HRBE 014 060 S04	0.7R X 1.4	1.4	6	45	4	
2HRBE 014 080 S04	0.7R X 1.4	1.4	8	45	4	
2HRBE 014 120 S04	0.7R X 1.4	1.4	12	50	4	
2HRBE 014 160 S04	0.7R X 1.4	1.4	16	50	4	
2HRBE 015 030 S04	0.75R X 1.5	1.5	3	45	4	
2HRBE 015 040 S04	0.75R X 1.5	1.5	4	45	4	
2HRBE 015 060 S04	0.75R X 1.5	1.5	6	45	4	
2HRBE 015 080 S04	0.75R X 1.5	1.5	8	45	4	
2HRBE 015 100 S04	0.75R X 1.5	1.5	10	50	4	
2HRBE 015 120 S04	0.75R X 1.5	1.5	12	50	4	
2HRBE 015 140 S04	0.75R X 1.5	1.5	14	50	4	
2HRBE 015 160 S04	0.75R X 1.5	1.5	16	50	4	
2HRBE 015 180 S04	0.75R X 1.5	1.5	18	50	4	
2HRBE 015 200 S04	0.75R X 1.5	1.5	20	50	4	
2HRBE 015 220 S04	0.75R X 1.5	1.5	22	60	4	
2HRBE 015 250 S04	0.75R X 1.5	1.5	25	60	4	
2HRBE 015 300 S04	0.75R X 1.5	1.5	30	70	4	
2HRBE 016 060 S04	0.8R X 1.6	1.6	6	45	4	
2HRBE 016 080 S04	0.8R X 1.6	1.6	8	45	4	
2HRBE 016 120 S04	0.8R X 1.6	1.6	12	50	4	
2HRBE 016 160 S04	0.8R X 1.6	1.6	16	50	4	
2HRBE 016 200 S04	0.8R X 1.6	1.6	20	50	4	
2HRBE 018 060 S04	0.9R X 1.8	1.8	6	45	4	
2HRBE 018 080 S04	0.9R X 1.8	1.8	8	45	4	
2HRBE 018 120 S04	0.9R X 1.8	1.8	12	50	4	

단위 : mm

Order Number	날경 Diameter R × D	날장 Length of cut L1	유효장 Effective Length L2	전장 Overall Length L	생크 Shank Dia d	비고	Order Number	날경 Diameter R × D	날장 Length of cut L1	유효장 Effective Length L2	전장 Overall Length L	생크 Shank Dia d	비고
2HRBE 018 160 S04	0.9R X 1.8	1.8	16	50	4		2HRBE 100 300 070	5R X 10	16	30	70	10	
2HRBE 018 200 S04	0.9R X 1.8	1.8	20	50	4		2HRBE 120 300 075	6R X 12	18	30	75	12	
2HRBE 020 040 S04	1R X 2	2	4	45	4								
2HRBE 020 060 S04	1R X 2	2	6	45	4								
2HRBE 020 080 S04	1R X 2	2	8	45	4								
2HRBE 020 100 S04	1R X 2	2	10	50	4								
2HRBE 020 120 S04	1R X 2	2	12	50	4								
2HRBE 020 140 S04	1R X 2	2	14	50	4								
2HRBE 020 160 S04	1R X 2	2	16	50	4								
2HRBE 020 180 S04	1R X 2	2	18	50	4								
2HRBE 020 200 S04	1R X 2	2	20	50	4								
2HRBE 020 220 S04	1R X 2	2	22	60	4								
2HRBE 020 250 S04	1R X 2	2	25	60	4								
2HRBE 020 300 S04	1R X 2	2	30	60	4								
2HRBE 025 080 S04	1.25R X 2.5	2.5	8	45	4								
2HRBE 025 100 S04	1.25R X 2.5	2.5	10	50	4								
2HRBE 025 120 S04	1.25R X 2.5	2.5	12	50	4								
2HRBE 025 160 S04	1.25R X 2.5	2.5	16	50	4								
2HRBE 025 200 S04	1.25R X 2.5	2.5	20	60	4								
2HRBE 025 250 S04	1.25R X 2.5	2.5	25	60	4								
2HRBE 025 300 S04	1.25R X 2.5	2.5	30	70	4								
2HRBE 030 060 S06	1.5R X 3	3	6	50	6								
2HRBE 030 080 S06	1.5R X 3	3	8	50	6								
2HRBE 030 100 S06	1.5R X 3	3	10	50	6								
2HRBE 030 120 S06	1.5R X 3	3	12	50	6								
2HRBE 030 160 S06	1.5R X 3	3	16	60	6								
2HRBE 030 200 S06	1.5R X 3	3	20	60	6								
2HRBE 030 250 S06	1.5R X 3	3	25	65	6								
2HRBE 030 300 S06	1.5R X 3	3	30	70	6								
2HRBE 030 350 S06	1.5R X 3	3	35	75	6								
2HRBE 030 400 S06	1.5R X 3	3	40	80	6								
2HRBE 030 450 S06	1.5R X 3	3	45	90	6								
2HRBE 040 080 S06	2R X 4	4	8	50	6								
2HRBE 040 100 S06	2R X 4	4	10	50	6								
2HRBE 040 120 S06	2R X 4	4	12	50	6								
2HRBE 040 160 S06	2R X 4	4	16	60	6								
2HRBE 040 200 S06	2R X 4	4	20	60	6								
2HRBE 040 250 S06	2R X 4	4	25	65	6								
2HRBE 040 300 S06	2R X 4	4	30	70	6								
2HRBE 040 350 S06	2R X 4	4	35	75	6								
2HRBE 040 400 S06	2R X 4	4	40	80	6								
2HRBE 040 450 S06	2R X 4	4	45	90	6								
2HRBE 050 160 S06	2.5R X 5	6	16	60	6								
2HRBE 050 200 S06	2.5R X 5	6	20	60	6								
2HRBE 050 250 S06	2.5R X 5	6	25	70	6								
2HRBE 050 300 S06	2.5R X 5	6	30	75	6								
2HRBE 050 400 S06	2.5R X 5	6	40	80	6								
2HRBE 050 500 S06	2.5R X 5	6	50	90	6								
2HRBE 060 150 S06	3R X 6	10	15	55	6								
2HRBE 080 250 060	4R X 8	12	25	60	8								

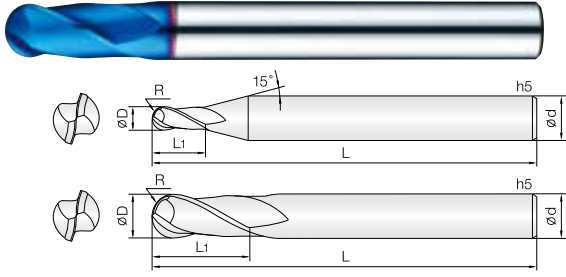

- 중저경도강(HRc52이하), 프리하든강 계열, 탄소강, 금형강등 다양한 피삭재 가공 엔드밀
- 고품량 실리콘계 코팅(Si)처리하여 내마모성이 우수합니다.
- 넓은 영역의 피삭재 가공에 적합한 형상으로 설계 하였습니다.
- 경제적인 가격으로 가공 생산비 절감을 극대화합니다.
- 항절삭력이 높은 미립자 초경합금(0.5μm)을 채택, 엔드밀의 파손을 최소화 하였습니다.

- Endmills for various work materials (~HRc52), pre-hardened steels, carbon steels, mold steels
- Good wear resistance by high quality Si-based PVD coating.
- Suitable shape is designed for tooling in wide areas.
- Maximize the manufacturing cost saving with low price of products.
- Minimize fracturing by high TRS fine(0.5μm) WC grade.

E series

2

WC  
미립자

BLUE  
Coating

R  
± 0.005

R  
± 0.01

R  
± 0.015

30°  
Helix Angle

CUTTING  
DATA

0.1 ~ 2.5R
3 ~ 6R
8R
443P

Condition	D Size	D Tolerance
ØD ≠ Ød	Ø0.2 ~ 16	+0 ~ -0.01mm

Condition	D Size	D Tolerance
ØD = Ød	Ø4 ~ 12	-0.005 ~ -0.015mm
	Ø16	-0.01 ~ -0.02mm

단위 : mm

Order Number	날경 Diameter R × D	날장 Length of cut L1	전장 Overall Length L	샙크 Dia d	비고
2HCBE 002 004 S04	0.1R X 0.2	0.4	40	4	
2HCBE 003 006 S04	0.15R X 0.3	0.6	40	4	
2HCBE 004 008 S04	0.2R X 0.4	0.8	40	4	
2HCBE 005 010 S04	0.25R X 0.5	1	45	4	
2HCBE 006 012 S04	0.3R X 0.6	1.2	45	4	
2HCBE 007 014 S04	0.35R X 0.7	1.4	45	4	
2HCBE 008 016 S04	0.4R X 0.8	1.6	45	4	
2HCBE 009 018 S04	0.45R X 0.9	1.8	45	4	
2HCBE 010 025 S04	0.5R X 1	2.5	50	4	
2HCBE 010 025 S06	0.5R X 1	2.5	50	6	
2HCBE 012 030 S04	0.6R X 1.2	3	50	4	
2HCBE 015 040 S04	0.75R X 1.5	4	50	4	
2HCBE 015 040 S06	0.75R X 1.5	4	50	6	
2HCBE 020 050 S04	1R X 2	5	50	4	
2HCBE 020 050 S06	1R X 2	5	50	6	
2HCBE 025 050 S04	1.25R X 2.5	5	50	4	
2HCBE 025 050 S06	1.25R X 2.5	5	50	6	
2HCBE 030 060 S04	1.5R X 3	6	50	4	
2HCBE 030 060 S06	1.5R X 3	6	50	6	
2HCBE 030 060 060	1.5R X 3	6	60	6	
2HCBE 040 080 S04	2R X 4	8	50	4	
2HCBE 040 080 080	2R X 4	8	80	4	
2HCBE 040 080 S06	2R X 4	8	50	6	
2HCBE 040 080 070	2R X 4	8	70	6	
2HCBE 050 100 S06	2.5R X 5	10	50	6	
2HCBE 050 120 S06	2.5R X 5	12	80	6	
2HCBE 060 100 050	3R X 6	10	50	6	
2HCBE 060 100 060	3R X 6	10	60	6	
2HCBE 060 120 080	3R X 6	12	80	6	
2HCBE 060 120 100	3R X 6	12	100	6	
2HCBE 080 120 060	4R X 8	12	60	8	
2HCBE 080 140 080	4R X 8	14	80	8	
2HCBE 080 140 100	4R X 8	14	100	8	
2HCBE 100 150 075	5R X 10	15	75	10	
2HCBE 100 180 100	5R X 10	18	100	10	
2HCBE 120 180 080	6R X 12	18	80	12	
2HCBE 120 220 110	6R X 12	22	110	12	
2HCBE 160 300 110	8R X 16	30	110	16	



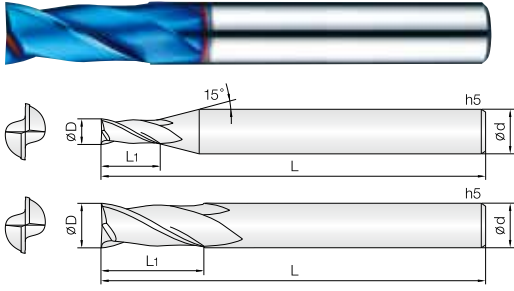

- 중저경도강(HRc52이하), 프리하든강 계열, 탄소강, 금형강등 다양한 피삭재 가공 엔드밀
- 고탄량 실리콘계 코팅(Si)처리하여 내마모성이 우수합니다.
- 넓은 영역의 피삭재 가공에 적합한 형상으로 설계 하였습니다.
- 경제적인 가격으로 가공 생산비 절감을 극대화합니다.
- 항절삭력이 높은 미립자 초경합금(0.5 $\mu$ m)을 채택, 엔드밀의 파손을 최소화 하였습니다.

#### • Endmills for various work materials (~HRc52), pre-hardened steels, carbon steels, mold steels

- Good wear resistance by high quality Si-based PVD coating.
- Suitable shape is designed for tooling in wide areas.
- Maximize the manufacturing cost saving with low price of products.
- Minimize fracturing by high TRS fine(0.5 $\mu$ m) WC grade.

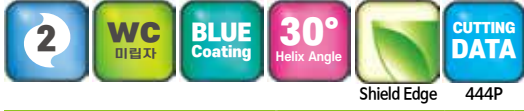

Condition	D Size	D Tolerance	Condition	D Size	D Tolerance
$\varnothing D \neq \varnothing d$	$\varnothing 0.2 \sim 6$	+0 ~ -0.01mm	$\varnothing D = \varnothing d$	$\varnothing 4 \sim 6$	-0.005 ~ -0.015mm
	$\varnothing 8 \sim 16$	+0 ~ -0.015mm		$\varnothing 8 \sim 12$	-0.01 ~ -0.025mm
		$\varnothing 16$		-0.015 ~ -0.03mm	

단위 : mm

Order Number	날경 Diameter D	날장 Length of cut L1	전장 Overall Length L	생크 Shank Dia d	비고	Order Number	날경 Diameter D	날장 Length of cut L1	전장 Overall Length L	생크 Shank Dia d	비고
2HCEE 002 004 S04	0.2	0.4	40	4							
2HCEE 003 006 S04	0.3	0.6	40	4							
2HCEE 004 008 S04	0.4	0.8	40	4							
2HCEE 005 010 S04	0.5	1	40	4							
2HCEE 006 012 S04	0.6	1.2	40	4							
2HCEE 007 014 S04	0.7	1.4	40	4							
2HCEE 008 016 S04	0.8	1.6	40	4							
2HCEE 009 018 S04	0.9	1.8	40	4							
2HCEE 010 025 S04	1	2.5	45	4							
2HCEE 012 030 S04	1.2	3	45	4							
2HCEE 015 040 S04	1.5	4	45	4							
2HCEE 020 060 S04	2	6	45	4							
2HCEE 025 080 S04	2.5	8	45	4							
2HCEE 030 080 S04	3	8	50	4							
2HCEE 030 080 S06	3	8	50	6							
2HCEE 040 110 S04	4	11	50	4							
2HCEE 040 110 S06	4	11	50	6							
2HCEE 050 130 S06	5	13	50	6							
2HCEE 060 130 050	6	13	50	6							
2HCEE 060 160 055	6	16	55	6							
2HCEE 080 200 060	8	20	60	8							
2HCEE 080 240 070	8	24	70	8							
2HCEE 100 220 070	10	22	70	10							
2HCEE 100 250 075	10	25	75	10							
2HCEE 120 260 075	12	26	75	12							
2HCEE 120 300 080	12	30	80	12							
2HCEE 160 400 090	16	40	90	16							





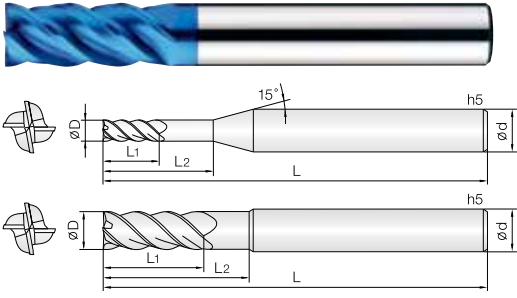

- 중저경도강 (HRC52이하), 프리하든강계열, 탄소강, 금형강, SUS계열, Ti/Ni계합금, 인코넬등 다양한 피삭재 가공 엔드밀
- 고함량 실리콘계 코팅 (Si) 처리하여 내마모성이 우수합니다.
- 강력한 체터링 방지 설계로 엔드밀의 진동을 최소화하였습니다.
- 항질력이 높은 미립자 초경합금 (0.5µm)을 채택, 엔드밀의 파손을 최소화 하였습니다.

- Endmills for various work materials (~HRC52), pre-hardened steels, carbon steels, mold steels
- Good wear resistance by high quality Si-based PVD coating.
- Minimize chattering by unequal flute spacing design.
- Minimize fracturing by high TRS fine (0.5µm) WC grade.

E series

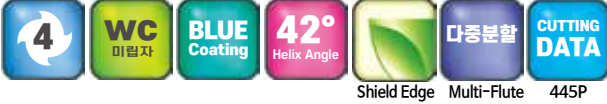

Condition	D Size	D Tolerance	Condition	D Size	D Tolerance
ØD ≠ Ød	Ø1 ~ 6	+0 ~ -0.01mm	ØD = Ød	Ø6	-0.005 ~ -0.015mm
	Ø8 ~ 20	+0 ~ -0.015mm		Ø8 ~ 12	-0.01 ~ -0.025mm
		Ø14 ~ 20		-0.015 ~ -0.03mm	

단위 : mm

Order Number	날경 Diameter D	날장 Length of cut L1	유효장 Effective Length L2	전장 Overall Length L	셱크 Shank Dia d	비고	Order Number	날경 Diameter D	날장 Length of cut L1	유효장 Effective Length L2	전장 Overall Length L	셱크 Shank Dia d	비고
4NSE 010 025 S04	1	2.5	-	45	4								
4NSE 010 040 S04	1	2.5	4	45	4								
4NSE 012 030 S04	1.2	3	-	45	4								
4NSE 012 050 S04	1.2	3	5	45	4								
4NSE 015 040 S04	1.5	4	-	45	4								
4NSE 015 060 S04	1.5	4	6	45	4								
4NSE 020 060 S04	2	6	-	45	4								
4NSE 020 100 S04	2	6	10	45	4								
4NSE 025 070 S04	2.5	7	-	45	4								
4NSE 025 100 S04	2.5	7	10	45	4								
4NSE 030 080 S06	3	8	-	50	6								
4NSE 030 100 S06	3	10	-	50	6								
4NSE 030 120 S06	3	8	12	50	6								
4NSE 040 100 S06	4	10	-	50	6								
4NSE 040 120 S06	4	12	-	50	6								
4NSE 040 160 S06	4	10	16	50	6								
4NSE 050 120 S06	5	12	-	55	6								
4NSE 050 160 S06	5	16	-	55	6								
4NSE 050 200 S06	5	12	20	55	6								
4NSE 060 130 S06	6	13	-	55	6								
4NSE 060 180 S06	6	18	-	55	6								
4NSE 060 210 055	6	13	21	55	6								
4NSE 080 200 S08	8	20	-	60	8								
4NSE 080 250 S08	8	25	-	70	8								
4NSE 080 270 070	8	20	27	70	8								
4NSE 100 220 S10	10	22	-	70	10								
4NSE 100 300 S10	10	30	-	75	10								
4NSE 100 320 075	10	22	32	75	10								
4NSE 120 260 S12	12	26	-	75	12								
4NSE 120 300 S12	12	30	-	80	12								
4NSE 120 380 080	12	26	38	80	12								
4NSE 140 320 090	14	32	-	90	14								
4NSE 160 450 S16	16	35	45	90	16								
4NSE 200 520 S20	20	40	52	100	20								

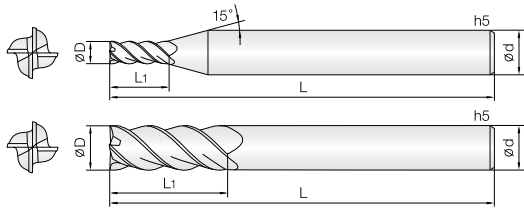

- 중저경도강(HRc52이하), 프리하든강 계열, 탄소강, 금형강등 다양한 피삭재 가공 엔드밀
- 고품질 실리콘계 코팅(Si)처리하여 내마모성이 우수합니다.
- 넓은 영역의 피삭재 가공에 적합한 형상으로 설계 하였습니다.
- 45° 헬릭스 형상으로 설계하여 고속, 고이송 가공에 적합합니다.
- 항절력이 높은 미립자 초경합금(0.5 $\mu$ m)을 채택, 엔드밀의 파손을 최소화 하였습니다.

#### Endmills for various work materials (~HRc52), pre-hardened steels, carbon steels, mold steels

- Good wear resistance by high quality Si-based PVD coating.
- Suitable shape is designed for tooling in wide areas.
- 45° degree helix design for high speed, feed condition.
- Minimize fracturing by high TRS fine(0.5 $\mu$ m) WC grade.



Shield Edge 446P

Condition	D Size	D Tolerance	Condition	D Size	D Tolerance
øD ≠ ød	ø1 ~ 6	+0 ~ -0.01mm	øD = ød	ø6	-0.005 ~ -0.015mm
	ø8 ~ 16	+0 ~ -0.015mm		ø8 ~ 12	-0.01 ~ -0.025mm
				ø14 ~ 16	-0.015 ~ -0.03mm

단위 : mm

Order Number	날경 Diameter D	날장 Length of cut L1	전장 Overall Length L	샤프트 Shank Dia d	비고	Order Number	날경 Diameter D	날장 Length of cut L1	전장 Overall Length L	샤프트 Shank Dia d	비고
4HEME 010 025 S04	1	2.5	40	4							
4HEME 010 025 S06	1	2.5	40	6							
4HEME 010 035 S04	1	3.5	40	4							
4HEME 010 035 S06	1	3.5	40	6							
4HEME 012 030 S04	1.2	3	40	4							
4HEME 012 030 S06	1.2	3	40	6							
4HEME 015 040 S04	1.5	4	40	4							
4HEME 015 060 S04	1.5	6	40	4							
4HEME 015 060 S06	1.5	6	40	6							
4HEME 020 050 S04	2	5	40	4							
4HEME 020 080 S04	2	8	40	4							
4HEME 020 080 S06	2	8	45	6							
4HEME 030 080 S06	3	8	45	6							
4HEME 030 120 S06	3	12	50	6							
4HEME 040 110 S06	4	11	45	6							
4HEME 040 160 S06	4	16	55	6							
4HEME 050 130 S06	5	13	50	6							
4HEME 050 180 S06	5	18	60	6							
4HEME 060 130 S06	6	13	50	6							
4HEME 060 200 S06	6	20	60	6							
4HEME 080 200 S08	8	20	60	8							
4HEME 080 250 S08	8	25	70	8							
4HEME 080 300 S08	8	30	75	8							
4HEME 100 220 S10	10	22	70	10							
4HEME 100 300 S10	10	30	80	10							
4HEME 100 400 S10	10	40	90	10							
4HEME 120 260 S12	12	26	75	12							
4HEME 120 400 S12	12	40	90	12							
4HEME 120 500 S12	12	50	100	12							
4HEME 140 300 S14	14	30	80	14							
4HEME 140 500 S14	14	50	110	14							
4HEME 160 350 S16	16	35	90	16							
4HEME 160 500 S16	16	50	110	16							





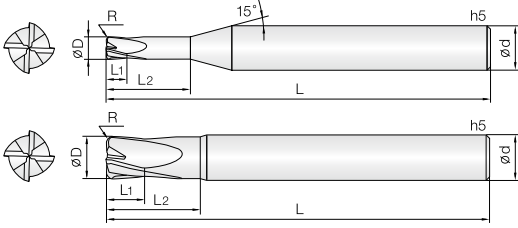

- 중저경도강(HRc52이하), 프리하든강 계열, 탄소강, 금형강 등 가공
- 고품량 실리콘계 코팅(Si)처리하여 내마모성이 우수합니다.
- 저속 RPM에서 고이송 작업이 가능 하도록 설계하였습니다.
- 종삭 및 황삭 가공시 작업 효율이 극대화 됩니다.
- 항절력이 높은 미립자 초경합금을 채택하여, 고이송 작업시 엔드밀의 파손을 최소화 하였습니다.

#### Endmills for various work materials (~HRc52), pre-hardened steels, carbon steels, mold steels

- Good wear resistance by high quality Si-based PVD coating.
- Designed for low speed with high feed condition.
- Suitable for heavy duty and roughing application.
- Minimize fracturing at high feed by high TRS ultra fine WC grade.

E series

4

WC  
미립자

BLUE  
Coating

R  
± 0.005

R  
± 0.01

R  
± 0.015

15°  
Helix Angle

CUTTING  
DATA

0.2 ~ 0.5R    1 ~ 1.5R    2 ~ 3R    448P

Condition	D Size	D Tolerance	Condition	D Size	D Tolerance
ØD ≠ Ød	Ø1 ~ 12	+0 ~ -0.01mm	ØD = Ød	Ø6 ~ 12	-0.005 ~ -0.015mm

단위 : mm

Order Number	날경 Diameter D × R	날장 Length of cut L1	유효장 Effective Length L2	전장 Overall Length L	샤프크 Shank Dia d	비고	Order Number	날경 Diameter D × R	날장 Length of cut L1	유효장 Effective Length L2	전장 Overall Length L	샤프크 Shank Dia d	비고
4RCUE 010 002 025	1 X R0.2	0.75	2.5	50	4								
4RCUE 015 005 040	1.5 X R0.5	1.2	4	50	4								
4RCUE 020 005 060	2 X R0.5	1.5	6	50	6								
4RCUE 030 005 080	3 X R0.5	2.3	8	50	6								
4RCUE 040 005 120	4 X R0.5	3	12	60	6								
4RCUE 040 005 160	4 X R0.5	3	16	60	6								
4RCUE 040 010 120	4 X R1	3	12	60	6								
4RCUE 040 010 160	4 X R1	3	16	60	6								
4RCUE 050 005 150	5 X R0.5	4	15	60	6								
4RCUE 050 010 150	5 X R1	4	15	60	6								
4RCUE 060 005 150	6 X R0.5	4.5	15	60	6								
4RCUE 060 005 250	6 X R0.5	4.5	25	80	6								
4RCUE 060 010 150	6 X R1	4.5	15	60	6								
4RCUE 060 010 250	6 X R1	4.5	25	80	6								
4RCUE 060 015 150	6 X R1.5	4.5	15	60	6								
4RCUE 060 015 250	6 X R1.5	4.5	25	80	6								
4RCUE 080 005 200	8 X R0.5	6	20	60	8								
4RCUE 080 005 300	8 X R0.5	6	30	90	8								
4RCUE 080 010 200	8 X R1	6	20	60	8								
4RCUE 080 010 300	8 X R1	6	30	90	8								
4RCUE 080 020 200	8 X R2	6	20	60	8								
4RCUE 080 020 300	8 X R2	6	30	90	8								
4RCUE 100 005 250	10 X R0.5	7.5	25	70	10								
4RCUE 100 005 400	10 X R0.5	7.5	40	100	10								
4RCUE 100 010 250	10 X R1	7.5	25	70	10								
4RCUE 100 010 400	10 X R1	7.5	40	100	10								
4RCUE 100 020 250	10 X R2	7.5	25	70	10								
4RCUE 100 020 400	10 X R2	7.5	40	100	10								
4RCUE 120 005 300	12 X R0.5	9	30	80	12								
4RCUE 120 005 400	12 X R0.5	9	40	100	12								
4RCUE 120 010 300	12 X R1	9	30	80	12								
4RCUE 120 010 400	12 X R1	9	40	100	12								
4RCUE 120 020 300	12 X R2	9	30	80	12								
4RCUE 120 020 400	12 X R2	9	40	100	12								
4RCUE 120 030 300	12 X R3	9	30	80	12								









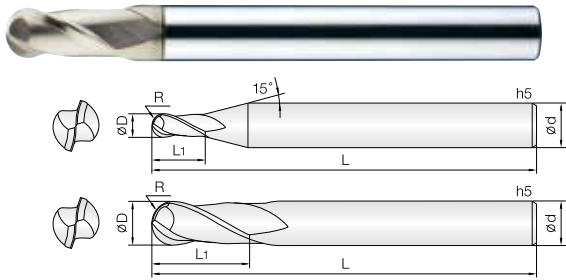

- 중저경도강(HRc52이하), 프리하든강 계열, 탄소강, 금형강 등 다양한 피삭재 가공
- JCRO 코팅 처리하여 넓은 영역의 피삭재 가공에 적합합니다.
- 고정밀 공차 적용으로 초정밀 가공에 적합합니다.
- 항절력이 높은 미립자 초경합금(0.5 $\mu$ m)를 채택, 엔드밀의 파손을 최소화 하였습니다.

- Endmills for various work materials (~HRc52), pre-hardened steels, carbon steels, mold steels
- Optimum for various work materials by JCRO coating.
- High precise edge tolerance.
- Minimize fracturing by high TRS fine(0.5 $\mu$ m) WC grade.

G series



0.05~2.75R 3~6R 6.5~10R 452P

Condition	D Size		D Tolerance	
	$\varnothing D \neq \varnothing d$	$\varnothing D = \varnothing d$	$\varnothing D = 12$	$\varnothing D = 14 \sim 20$
	$\varnothing 0.1 \sim 0.15$	$\varnothing 4 \sim 12$	+0 ~ -0.005mm	-0.005 ~ -0.015mm
	$\varnothing 0.2 \sim 20$	$\varnothing 14 \sim 20$	+0 ~ -0.01mm	-0.01 ~ -0.02mm

단위 : mm

Order Number	날경 Diameter R × D	날장 Length of cut L1	전장 Overall Length L	샤프트 Shank Dia d	비고	Order Number	날경 Diameter R × D	날장 Length of cut L1	전장 Overall Length L	샤프트 Shank Dia d	비고
2HCBG 001 002 S04	0.05R X 0.1	0.2	40	4		2HCBG 080 140 150	4R X 8	14	150	8	
2HCBG 0015 003 S04	0.075R X 0.15	0.3	40	4		2HCBG 090 160 S10	4.5R X 9	16	100	10	
2HCBG 002 004 S04	0.1R X 0.2	0.4	40	4		2HCBG 100 150 070	5R X 10	15	70	10	
2HCBG 003 006 S04	0.15R X 0.3	0.6	40	4		2HCBG 100 180 100	5R X 10	18	100	10	
2HCBG 004 008 S04	0.2R X 0.4	0.8	40	4		2HCBG 100 180 120	5R X 10	18	120	10	
2HCBG 005 010 S04	0.25R X 0.5	1	45	4		2HCBG 100 180 150	5R X 10	18	150	10	
2HCBG 006 012 S04	0.3R X 0.6	1.2	45	4		2HCBG 100 180 180	5R X 10	18	180	10	
2HCBG 007 015 S04	0.35R X 0.7	1.5	45	4		2HCBG 110 200 S12	5.5R X 11	20	110	12	
2HCBG 008 020 S04	0.4R X 0.8	2	45	4		2HCBG 120 180 070	6R X 12	18	70	12	
2HCBG 009 020 S04	0.45R X 0.9	2	45	4		2HCBG 120 220 110	6R X 12	22	110	12	
2HCBG 010 025 S04	0.5R X 1	2.5	50	4		2HCBG 120 220 130	6R X 12	22	130	12	
2HCBG 010 025 S06	0.5R X 1	2.5	50	6		2HCBG 120 220 150	6R X 12	22	150	12	
2HCBG 010 025 070	0.5R X 1	2.5	70	6		2HCBG 120 220 200	6R X 12	22	200	12	
2HCBG 010 025 100	0.5R X 1	2.5	100	6		2HCBG 130 240 S14	6.5R X 13	24	110	14	
2HCBG 012 030 S04	0.6R X 1.2	3	50	4		2HCBG 140 240 S14	7R X 14	24	110	14	
2HCBG 015 040 S04	0.75R X 1.5	4	50	4		2HCBG 160 300 130	8R X 16	30	130	16	
2HCBG 015 040 S06	0.75R X 1.5	4	50	6		2HCBG 160 300 160	8R X 16	30	160	16	
2HCBG 015 040 070	0.75R X 1.5	4	70	6		2HCBG 160 300 200	8R X 16	30	200	16	
2HCBG 015 040 100	0.75R X 1.5	4	100	6		2HCBG 200 380 160	10R X 20	38	160	20	
2HCBG 020 050 S04	1R X 2	5	50	4		2HCBG 200 380 200	10R X 20	38	200	20	
2HCBG 020 050 S06	1R X 2	5	50	6							
2HCBG 020 050 075	1R X 2	5	75	6							
2HCBG 020 050 100	1R X 2	5	100	6							
2HCBG 025 060 S04	1.25R X 2.5	6	50	4							
2HCBG 025 060 S06	1.25R X 2.5	6	60	6							
2HCBG 025 060 075	1.25R X 2.5	6	75	6							
2HCBG 025 060 100	1.25R X 2.5	6	100	6							
2HCBG 030 080 S03	1.5R X 3	8	60	3							
2HCBG 030 080 S04	1.5R X 3	8	50	4							
2HCBG 030 080 S06	1.5R X 3	8	60	6							
2HCBG 030 080 080	1.5R X 3	8	80	6							
2HCBG 030 080 100	1.5R X 3	8	100	6							
2HCBG 035 080 S06	1.75R X 3.5	8	60	6							
2HCBG 040 080 060	2R X 4	8	60	4							
2HCBG 040 080 080	2R X 4	8	80	4							
2HCBG 040 080 S06	2R X 4	8	70	6							
2HCBG 040 080 090	2R X 4	8	90	6							
2HCBG 040 080 120	2R X 4	8	120	6							
2HCBG 045 080 S06	2.25R X 4.5	8	70	6							
2HCBG 050 080 S05	2.5R X 5	8	80	5							
2HCBG 050 100 S06	2.5R X 5	10	75	6							
2HCBG 055 100 S06	2.75R X 5.5	10	75	6							
2HCBG 060 100 060	3R X 6	10	60	6							
2HCBG 060 120 080	3R X 6	12	80	6							
2HCBG 060 120 100	3R X 6	12	100	6							
2HCBG 060 120 120	3R X 6	12	120	6							
2HCBG 070 140 S08	3.5R X 7	14	80	8							
2HCBG 080 120 060	4R X 8	12	60	8							
2HCBG 080 140 090	4R X 8	14	90	8							
2HCBG 080 140 110	4R X 8	14	110	8							



단위 : mm

Order Number	날경 Diameter D	날장 Length of cut L1	유효장 Effective Length L2	전장 Overall Length L	샙크 Shank Dia d	비고	Order Number	날경 Diameter D	날장 Length of cut L1	유효장 Effective Length L2	전장 Overall Length L	샙크 Shank Dia d	비고
2HREG 018 180 S04	1.8	2.1	18	50	4		2HREG 040 500 S06	4	4.8	50	100	6	
2HREG 020 040 S04	2	2.4	4	45	4		2HREG 040 550 S06	4	4.8	55	100	6	
2HREG 020 060 S04	2	2.4	6	45	4		2HREG 040 600 S06	4	4.8	60	100	6	
2HREG 020 080 S04	2	2.4	8	45	4		2HREG 050 150 S06	5	6	15	55	6	
2HREG 020 100 S04	2	2.4	10	50	4		2HREG 050 200 S06	5	6	20	60	6	
2HREG 020 120 S04	2	2.4	12	50	4		2HREG 050 250 S06	5	6	25	70	6	
2HREG 020 140 S04	2	2.4	14	50	4		2HREG 050 300 S06	5	6	30	75	6	
2HREG 020 160 S04	2	2.4	16	50	4		2HREG 050 350 S06	5	6	35	75	6	
2HREG 020 180 S04	2	2.4	18	50	4		2HREG 050 400 S06	5	6	40	80	6	
2HREG 020 200 S04	2	2.4	20	50	4		2HREG 050 500 S06	5	6	50	100	6	
2HREG 020 220 S04	2	2.4	22	60	4		2HREG 050 600 S06	5	6	60	100	6	
2HREG 020 250 S04	2	2.4	25	60	4		2HREG 060 200 S06	6	10	20	60	6	
2HREG 020 300 S04	2	2.4	30	70	4		2HREG 060 300 S06	6	10	30	75	6	
2HREG 020 350 S04	2	2.4	35	70	4		2HREG 060 400 S06	6	10	40	80	6	
2HREG 020 400 S04	2	2.4	40	80	4		2HREG 060 500 S06	6	10	50	90	6	
2HREG 020 450 S04	2	2.4	45	80	4		2HREG 060 600 S06	6	10	60	110	6	
2HREG 020 500 S04	2	2.4	50	90	4		2HREG 080 200 S08	8	12	20	65	8	
2HREG 025 080 S04	2.5	3	8	45	4		2HREG 080 300 S08	8	12	30	80	8	
2HREG 025 100 S04	2.5	3	10	50	4		2HREG 080 400 S08	8	12	40	100	8	
2HREG 025 120 S04	2.5	3	12	50	4		2HREG 100 250 S10	10	15	25	70	10	
2HREG 025 160 S04	2.5	3	16	50	4		2HREG 100 350 S10	10	15	35	80	10	
2HREG 025 200 S04	2.5	3	20	50	4		2HREG 100 450 S10	10	15	45	100	10	
2HREG 025 250 S04	2.5	3	25	60	4		2HREG 120 300 S12	12	18	30	80	12	
2HREG 025 300 S04	2.5	3	30	70	4		2HREG 120 400 S12	12	18	40	100	12	
2HREG 025 350 S04	2.5	3	35	70	4		2HREG 120 500 S12	12	18	50	120	12	
2HREG 025 400 S04	2.5	3	40	80	4								
2HREG 025 500 S04	2.5	3	50	90	4								
2HREG 030 060 S06	3	3.6	6	45	6								
2HREG 030 080 S06	3	3.6	8	45	6								
2HREG 030 100 S06	3	3.6	10	50	6								
2HREG 030 120 S06	3	3.6	12	50	6								
2HREG 030 160 S06	3	3.6	16	55	6								
2HREG 030 200 S06	3	3.6	20	60	6								
2HREG 030 250 S06	3	3.6	25	65	6								
2HREG 030 300 S06	3	3.6	30	70	6								
2HREG 030 350 S06	3	3.6	35	75	6								
2HREG 030 400 S06	3	3.6	40	80	6								
2HREG 030 450 S06	3	3.6	45	90	6								
2HREG 030 500 S06	3	3.6	50	100	6								
2HREG 030 600 S06	3	3.6	60	100	6								
2HREG 040 080 S06	4	4.8	8	45	6								
2HREG 040 100 S06	4	4.8	10	50	6								
2HREG 040 120 S06	4	4.8	12	50	6								
2HREG 040 160 S06	4	4.8	16	55	6								
2HREG 040 200 S06	4	4.8	20	60	6								
2HREG 040 250 S06	4	4.8	25	65	6								
2HREG 040 300 S06	4	4.8	30	70	6								
2HREG 040 350 S06	4	4.8	35	75	6								
2HREG 040 400 S06	4	4.8	40	80	6								
2HREG 040 450 S06	4	4.8	45	90	6								







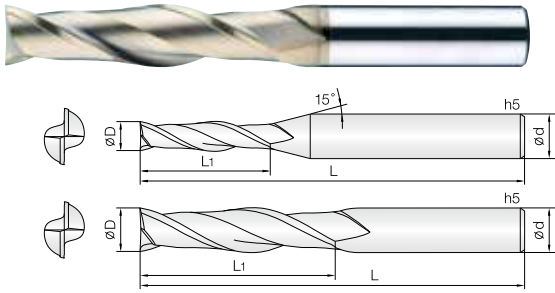

- 중저경도강 (HRC52이하), 프리하든강 계열, 탄소강, 금형강 등 다양한 피삭재 가공
- 균일한 런아웃 공차관리로 공구의 성능을 향상시켰습니다.
- 다양한 날길기와 전장을 채택, 다양한 작업에 효율성을 극대화 하였습니다.
- 코너부 강성을 보강하여 날부치평을 최소화 하였습니다.

#### • Endmills for various work materials (~HRC52), pre-hardened steels, carbon steels, mold steels

- Improve tool performance by even run-out and tolerance control.
- Various flute and overall length design for covering wide range applications as well as high efficiency machining.
- Minimize edge chipping by improving corner strength.



Shield Edge 457P

Condition	D Size	D Tolerance	Condition	D Size	D Tolerance
∅D ≠ ∅d	∅1 ~ 6	+0 ~ -0.01mm	∅D = ∅d	∅6	-0.005 ~ -0.015mm
	∅8 ~ 25	+0 ~ -0.015mm		∅8 ~ 12	-0.01 ~ -0.025mm
		∅14 ~ 25		-0.015 ~ -0.03mm	

단위 : mm

Order Number	날경 Diameter D	날장 Length of cut L1	전장 Overall Length L	샙크 Dia d	비고	Order Number	날경 Diameter D	날장 Length of cut L1	전장 Overall Length L	샙크 Dia d	비고
2LEMG 010 030 S06	1	3	60	6		2LEMG 160 700 S16	16	70	130	16	
2LEMG 010 050 S06	1	5	60	6		2LEMG 160 800 S16	16	80	160	16	
2LEMG 010 070 S06	1	7	60	6		2LEMG 200 500 160	20	50	160	20	
2LEMG 010 100 S06	1	10	60	6		2LEMG 200 600 S20	20	60	130	20	
2LEMG 010 150 S06	1	15	60	6		2LEMG 200 1000 S20	20	100	200	20	
2LEMG 015 060 S06	1.5	6	60	6		2LEMG 250 750 S25	25	75	160	25	
2LEMG 015 075 S06	1.5	7.5	60	6							
2LEMG 015 100 S06	1.5	10	60	6							
2LEMG 015 150 S06	1.5	15	60	6							
2LEMG 015 200 S06	1.5	20	60	6							
2LEMG 020 060 S06	2	6	60	6							
2LEMG 020 100 S06	2	10	60	6							
2LEMG 020 150 S06	2	15	60	6							
2LEMG 020 200 S06	2	20	60	6							
2LEMG 030 120 S06	3	12	70	6							
2LEMG 030 150 S06	3	15	70	6							
2LEMG 030 200 S06	3	20	70	6							
2LEMG 030 250 S06	3	25	70	6							
2LEMG 030 300 S06	3	30	70	6							
2LEMG 040 150 S06	4	15	70	6							
2LEMG 040 200 S06	4	20	70	6							
2LEMG 040 300 S06	4	30	75	6							
2LEMG 050 200 S06	5	20	70	6							
2LEMG 050 250 S06	5	25	75	6							
2LEMG 050 300 S06	5	30	80	6							
2LEMG 060 200 S06	6	20	75	6							
2LEMG 060 200 100	6	20	100	6							
2LEMG 060 250 S06	6	25	75	6							
2LEMG 060 300 S06	6	30	80	6							
2LEMG 080 250 S08	8	25	75	8							
2LEMG 080 250 100	8	25	100	8							
2LEMG 080 300 S08	8	30	80	8							
2LEMG 080 350 S08	8	35	80	8							
2LEMG 080 400 S08	8	40	90	8							
2LEMG 080 500 S08	8	50	100	8							
2LEMG 100 300 S10	10	30	80	10							
2LEMG 100 300 110	10	30	110	10							
2LEMG 100 350 S10	10	35	90	10							
2LEMG 100 400 S10	10	40	90	10							
2LEMG 100 500 S10	10	50	100	10							
2LEMG 100 600 S10	10	60	110	10							
2LEMG 120 300 S12	12	30	90	12							
2LEMG 120 350 110	12	35	110	12							
2LEMG 120 400 S12	12	40	100	12							
2LEMG 120 500 S12	12	50	100	12							
2LEMG 120 600 S12	12	60	110	12							
2LEMG 120 700 S12	12	70	130	12							
2LEMG 140 500 S14	14	50	110	14							
2LEMG 160 400 160	16	40	160	16							
2LEMG 160 550 S16	16	55	120	16							

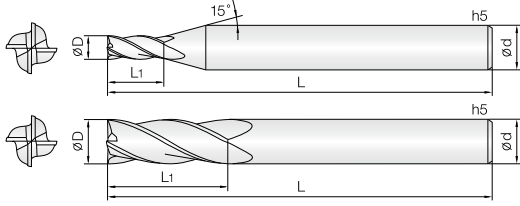

- 중저경도강(HRc52이하), 프리하든강 계열, 탄소강, 금형강 등 다양한 피삭재 가공
- JCRO 코팅 처리하여 넓은 영역의 피삭재 가공에 적합합니다.
- 고정밀 공차 적용으로 초정밀 가공에 적합합니다.
- 항절력이 높은 미립자 초경합금(0.5 $\mu$ m)를 채택, 엔드밀의 파손을 최소화 하였습니다.

#### Endmills for various work materials (~HRc52), pre-hardened steels, carbon steels, mold steels

- Optimum for various work materials by JCRO coating.
- High precise edge tolerance.
- Minimize fracturing by high TRS fine(0.5 $\mu$ m) WC grade.



Shield Edge 458P

Condition	D Size	D Tolerance	Condition	D Size	D Tolerance
$\varnothing D \neq \varnothing d$	$\varnothing 0.8 \sim 6$	+0 ~ -0.01mm	$\varnothing D = \varnothing d$	$\varnothing 4 \sim 6$	-0.005 ~ -0.015mm
	$\varnothing 6.5 \sim 20$	+0 ~ -0.015mm		$\varnothing 8 \sim 12$	-0.01 ~ -0.025mm
		$\varnothing 14 \sim 20$		-0.015 ~ -0.03mm	

단위 : mm

Order Number	날경 Diameter D	날장 Length of cut L1	전장 Overall Length L	샙크 Shank Dia d	비고	Order Number	날경 Diameter D	날장 Length of cut L1	전장 Overall Length L	샙크 Shank Dia d	비고
4HCEG 008 020 S04	0.8	2	40	4		4HCEG 080 080 S08	8	8	50	8	
4HCEG 010 010 S04	1	1	40	4		4HCEG 080 190 S08	8	19	60	8	
4HCEG 010 025 S04	1	2.5	40	4		4HCEG 080 200 S08	8	20	70	8	
4HCEG 010 025 S06	1	2.5	40	6		4HCEG 085 190 S10	8.5	19	70	10	
4HCEG 010 025 060	1	2.5	60	6		4HCEG 090 190 S10	9	19	70	10	
4HCEG 010 025 080	1	2.5	80	6		4HCEG 095 190 S10	9.5	19	70	10	
4HCEG 010 040 S06	1	4	50	6		4HCEG 100 100 S10	10	10	60	10	
4HCEG 012 012 S04	1.2	1.2	40	4		4HCEG 100 220 S10	10	22	70	10	
4HCEG 012 030 S04	1.2	3	40	4		4HCEG 100 250 S10	10	25	75	10	
4HCEG 012 030 S06	1.2	3	40	6		4HCEG 105 220 S12	10.5	22	75	12	
4HCEG 012 030 060	1.2	3	60	6		4HCEG 110 220 S12	11	22	75	12	
4HCEG 012 060 S06	1.2	6	50	6		4HCEG 115 220 S12	11.5	22	75	12	
4HCEG 015 015 S04	1.5	1.5	40	4		4HCEG 120 120 S12	12	12	65	12	
4HCEG 015 040 S04	1.5	4	40	4		4HCEG 120 260 S12	12	26	75	12	
4HCEG 015 040 S06	1.5	4	40	6		4HCEG 120 300 S12	12	30	80	12	
4HCEG 015 040 060	1.5	4	60	6		4HCEG 140 260 S14	14	26	80	14	
4HCEG 015 040 080	1.5	4	80	6		4HCEG 140 260 S16	14	26	85	16	
4HCEG 020 020 S04	2	2	40	4		4HCEG 160 350 S16	16	35	100	16	
4HCEG 020 060 S04	2	6	40	4		4HCEG 160 400 S16	16	40	100	16	
4HCEG 020 060 S06	2	6	40	6		4HCEG 180 350 S18	18	35	100	18	
4HCEG 020 060 060	2	6	60	6		4HCEG 200 400 S20	20	40	100	20	
4HCEG 020 060 100	2	6	100	6		4HCEG 200 450 S20	20	45	100	20	
4HCEG 025 080 S04	2.5	8	45	4							
4HCEG 025 080 S06	2.5	8	45	6							
4HCEG 025 080 070	2.5	8	70	6							
4HCEG 025 080 100	2.5	8	100	6							
4HCEG 030 080 S03	3	8	45	3							
4HCEG 030 080 S04	3	8	45	4							
4HCEG 030 080 S06	3	8	45	6							
4HCEG 030 080 070	3	8	70	6							
4HCEG 030 080 100	3	8	100	6							
4HCEG 035 100 S06	3.5	10	45	6							
4HCEG 040 040 S04	4	4	40	4							
4HCEG 040 110 S04	4	11	45	4							
4HCEG 040 110 S06	4	11	45	6							
4HCEG 040 110 070	4	11	70	6							
4HCEG 040 110 100	4	11	100	6							
4HCEG 045 110 S06	4.5	11	45	6							
4HCEG 050 130 S06	5	13	50	6							
4HCEG 050 130 080	5	13	80	6							
4HCEG 050 130 100	5	13	100	6							
4HCEG 055 130 S06	5.5	13	50	6							
4HCEG 060 060 S06	6	6	45	6							
4HCEG 060 130 S06	6	13	50	6							
4HCEG 060 130 080	6	13	80	6							
4HCEG 060 130 100	6	13	100	6							
4HCEG 060 150 S06	6	15	60	6							
4HCEG 065 160 S08	6.5	16	60	8							
4HCEG 070 160 S08	7	16	60	8							
4HCEG 075 160 S08	7.5	16	60	8							

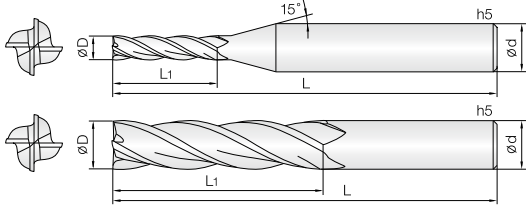

- 중저경도강 (HRC52이하), 프리하든강 계열, 탄소강, 금형강 등 다양한 피삭재 가공
- JCRO 코팅 처리하여 넓은 영역의 피삭재 가공에 적합합니다.
- 균일한 런아웃 공차관리로 공구의 성능을 향상시켰습니다.
- 다양한 날길기와 전장을 채택, 다양한 작업에 효율성을 극대화 하였습니다.
- 코너부 강성을 보강하여 날부치핑을 최소화 하였습니다.

#### • Endmills for various work materials (~HRC52), pre-hardened steels, carbon steels, mold steels

- Optimum for various work materials by JCRO coating.
- Improve tool performance by even run-out and tolerance control.
- Various flute and overall length design for covering wide range applications as well as high efficiency machining.
- Minimize edge chipping by improving corner strength.



Shield Edge 458P

Condition	D Size	D Tolerance
øD ≠ ød	ø1 ~ 6	+0 ~ -0.01mm
	ø8 ~ 25	+0 ~ -0.015mm

Condition	D Size	D Tolerance
øD = ød	ø4 ~ 6	-0.005 ~ -0.015mm
	ø8 ~ 12	-0.01 ~ -0.025mm
	ø14 ~ 25	-0.015 ~ -0.03mm

단위 : mm

Order Number	날경 Diameter D	날장 Length of cut L1	전장 Overall Length L	샙크 Shank Dia d	비고	Order Number	날경 Diameter D	날장 Length of cut L1	전장 Overall Length L	샙크 Shank Dia d	비고
4LEMG 010 030 S06	1	3	60	6		4LEMG 200 1000 S20	20	100	200	20	
4LEMG 010 050 S06	1	5	60	6		4LEMG 250 750 S25	25	75	160	25	
4LEMG 015 060 S06	1.5	6	60	6							
4LEMG 015 080 S06	1.5	8	60	6							
4LEMG 020 080 S06	2	8	60	6							
4LEMG 020 100 S06	2	10	60	6							
4LEMG 030 100 S06	3	10	70	6							
4LEMG 030 150 S06	3	15	70	6							
4LEMG 030 200 S06	3	20	70	6							
4LEMG 030 250 S06	3	25	70	6							
4LEMG 040 120 S06	4	12	70	6							
4LEMG 040 150 S04	4	15	70	4							
4LEMG 040 150 S06	4	15	70	6							
4LEMG 040 200 S04	4	20	70	4							
4LEMG 040 200 S06	4	20	70	6							
4LEMG 040 250 S06	4	25	70	6							
4LEMG 040 300 S06	4	30	75	6							
4LEMG 050 200 S06	5	20	70	6							
4LEMG 050 250 S06	5	25	75	6							
4LEMG 050 300 S06	5	30	80	6							
4LEMG 060 200 S06	6	20	75	6							
4LEMG 060 200 100	6	20	100	6							
4LEMG 060 250 S06	6	25	75	6							
4LEMG 060 300 S06	6	30	80	6							
4LEMG 060 350 S06	6	35	80	6							
4LEMG 080 250 S08	8	25	75	8							
4LEMG 080 250 100	8	25	100	8							
4LEMG 080 300 S08	8	30	80	8							
4LEMG 080 350 S08	8	35	90	8							
4LEMG 080 400 S08	8	40	90	8							
4LEMG 080 450 S08	8	45	100	8							
4LEMG 100 300 S10	10	30	80	10							
4LEMG 100 300 110	10	30	110	10							
4LEMG 100 350 S10	10	35	90	10							
4LEMG 100 400 S10	10	40	90	10							
4LEMG 100 500 S10	10	50	100	10							
4LEMG 100 600 S10	10	60	110	10							
4LEMG 120 300 S12	12	30	90	12							
4LEMG 120 350 110	12	35	110	12							
4LEMG 120 400 S12	12	40	100	12							
4LEMG 120 500 S12	12	50	100	12							
4LEMG 120 600 S12	12	60	110	12							
4LEMG 120 700 S12	12	70	130	12							
4LEMG 140 500 S14	14	50	110	14							
4LEMG 160 400 160	16	40	160	16							
4LEMG 160 550 S16	16	55	120	16							
4LEMG 160 700 S16	16	70	130	16							
4LEMG 180 800 160	18	80	160	18							
4LEMG 200 500 160	20	50	160	20							
4LEMG 200 600 S20	20	60	130	20							

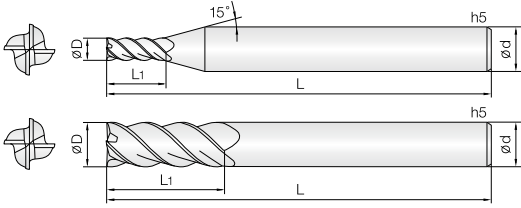

- 중저경도강(HRc52이하), 프리하든강 계열, 탄소강, 금형강 등 가공
- JCRO 코팅 처리하여 넓은 영역의 피삭재 가공에 적합합니다.
- 고정밀 공차 적용으로 초정밀 가공에 적합합니다.
- 45° 헬릭스 형상으로 설계하여 고속, 고이송 가공에 적합합니다.
- 항절력이 높은 미립자 초경합금(0.5μm)을 채택, 엔드밀의 파손을 최소화 하였습니다.

#### • Endmills for various work materials (~HRc52), pre-hardened steels, carbon steels, mold steels

- Optimum for various work materials by JCRO coating.
- High precise edge tolerance.
- 45° degree helix design for high speed, feed condition.
- Minimize fracturing by high TRS fine(0.5μm) WC grade.

Condition	D Size	D Tolerance	Condition	D Size	D Tolerance
	∅D ≠ ∅d	∅1 ~ 6 ∅8 ~ 20		+0 ~ -0.01mm +0 ~ -0.015mm	∅D = ∅d

단위 : mm



Order Number	날경 Diameter D	날장 Length of cut L1	전장 Overall Length L	샤프트 Shank Dia d	비고
4HEMG 010 025 S06	1	2.5	40	6	
4HEMG 010 035 S06	1	3.5	40	6	
4HEMG 015 040 S06	1.5	4	40	6	
4HEMG 015 060 S06	1.5	6	40	6	
4HEMG 020 050 S06	2	5	40	6	
4HEMG 020 080 S06	2	8	45	6	
4HEMG 030 080 S06	3	8	45	6	
4HEMG 030 120 S06	3	12	50	6	
4HEMG 040 110 S06	4	11	45	6	
4HEMG 040 160 S06	4	16	55	6	
4HEMG 050 130 S06	5	13	50	6	
4HEMG 050 180 S06	5	18	60	6	
4HEMG 060 130 S06	6	13	50	6	
4HEMG 060 200 S06	6	20	60	6	
4HEMG 080 200 S08	8	20	60	8	
4HEMG 080 250 S08	8	25	70	8	
4HEMG 100 220 S10	10	22	70	10	
4HEMG 100 300 S10	10	30	80	10	
4HEMG 120 260 S12	12	26	75	12	
4HEMG 120 400 S12	12	40	90	12	
4HEMG 120 500 S12	12	50	100	12	
4HEMG 160 350 S16	16	35	90	16	
4HEMG 160 500 S16	16	50	110	16	
4HEMG 200 400 S20	20	40	100	20	
4HEMG 200 500 S20	20	50	110	20	

Order Number	날경 Diameter D	날장 Length of cut L1	전장 Overall Length L	샤프트 Shank Dia d	비고

# 2CREG 2 Flutes Rib Corner Radius End Mills for Multi Purpose

## 2날 범용 리브 코너 레디우스 엔드밀

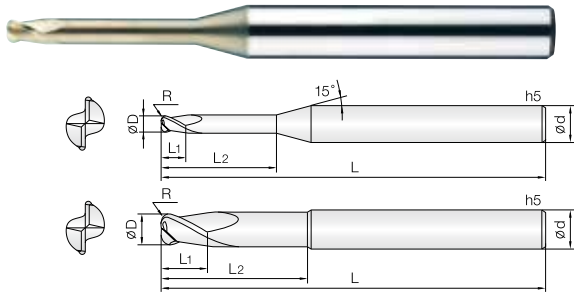

- 중저경도강(HRc52이하), 프리하드강 계열, 탄소강, 금형강 등 가공
- JCRO 코팅 처리하여 넓은 영역의 피삭재 가공에 적합합니다.
- 고정밀 공차 적용으로 초정밀 가공에 적합합니다.
- 코너R 형상을 날부치핑이 적도록 설계하였습니다.
- 다양한 코너R과 유효장으로 맞춤 가공이 가능합니다.
- 항절력이 높은 미립자 초경합금(0.5µm)을 채택, 엔드밀의 파손을 최소화

### • Endmills for various work materials(~HRc52), pre-hardened steels, carbon steels, mold steels

- Optimum for various work materials by JCRO coating.
- High precise edge tolerance.
- Designed for minimizing edge chipping by corner R shape.
- Various corner R and flute length for wide range application.
- Minimize fracturing by high TRS fine(0.5µm) WC grade.

2

WC  
미립자

JCRO  
Coating

R  
±0.005

R  
±0.01

R  
±0.015

35°  
Helix Angle

CUTTING  
DATA

R0.02 ~ 0.5    R1 ~ 1.5    R2 ~ 3    460P

Condition	D Size		D Tolerance	
	ØD ≠ Ød	Ø0.2 ~ 16	+0	-0 ~ -0.01mm
ØD = Ød	Ø4 - 12	-0.005 ~ -0.015mm		
	Ø16	-0.01 ~ -0.02mm		

단위 : mm

Order Number	날경 D × R	날장 Length of cut L1	유효장 Effective Length L2	전장 Overall Length L	생크 Shank Dia d	비고	Order Number	날경 D × R	날장 Length of cut L1	유효장 Effective Length L2	전장 Overall Length L	생크 Shank Dia d	비고
2CREG 002 0002 010	0.2 X R0.02	0.2	1	40	4		2CREG 008 002 040	0.8 X R0.2	0.9	4	45	4	
2CREG 002 0002 015	0.2 X R0.02	0.2	1.5	40	4		2CREG 008 002 060	0.8 X R0.2	0.9	6	45	4	
2CREG 002 0005 010	0.2 X R0.05	0.2	1	40	4		2CREG 008 002 080	0.8 X R0.2	0.9	8	45	4	
2CREG 002 0005 015	0.2 X R0.05	0.2	1.5	40	4		2CREG 010 001 040	1 X R0.1	1.2	4	45	4	
2CREG 003 0005 010	0.3 X R0.05	0.3	1	40	4		2CREG 010 001 060	1 X R0.1	1.2	6	45	4	
2CREG 003 0005 020	0.3 X R0.05	0.3	2	40	4		2CREG 010 001 080	1 X R0.1	1.2	8	45	4	
2CREG 003 0005 030	0.3 X R0.05	0.3	3	40	4		2CREG 010 001 100	1 X R0.1	1.2	10	50	4	
2CREG 004 0005 010	0.4 X R0.05	0.5	1	40	4		2CREG 010 001 120	1 X R0.1	1.2	12	50	4	
2CREG 004 0005 020	0.4 X R0.05	0.5	2	40	4		2CREG 010 001 160	1 X R0.1	1.2	16	50	4	
2CREG 004 0005 030	0.4 X R0.05	0.5	3	40	4		2CREG 010 001 200	1 X R0.1	1.2	20	50	4	
2CREG 004 0005 040	0.4 X R0.05	0.5	4	40	4		2CREG 010 002 040	1 X R0.2	1.2	4	45	4	
2CREG 004 001 010	0.4 X R0.1	0.5	1	40	4		2CREG 010 002 060	1 X R0.2	1.2	6	45	4	
2CREG 004 001 015	0.4 X R0.1	0.5	1.5	40	4		2CREG 010 002 080	1 X R0.2	1.2	8	45	4	
2CREG 004 001 020	0.4 X R0.1	0.5	2	40	4		2CREG 010 002 100	1 X R0.2	1.2	10	50	4	
2CREG 004 001 030	0.4 X R0.1	0.5	3	40	4		2CREG 010 002 120	1 X R0.2	1.2	12	50	4	
2CREG 004 001 040	0.4 X R0.1	0.5	4	40	4		2CREG 010 002 160	1 X R0.2	1.2	16	50	4	
2CREG 005 0005 010	0.5 X R0.05	0.6	1	45	4		2CREG 010 002 200	1 X R0.2	1.2	20	50	4	
2CREG 005 0005 015	0.5 X R0.05	0.6	1.5	45	4		2CREG 010 003 040	1 X R0.3	1.2	4	45	4	
2CREG 005 0005 020	0.5 X R0.05	0.6	2	45	4		2CREG 010 003 060	1 X R0.3	1.2	6	45	4	
2CREG 005 0005 025	0.5 X R0.05	0.6	2.5	45	4		2CREG 010 003 080	1 X R0.3	1.2	8	45	4	
2CREG 005 0005 030	0.5 X R0.05	0.6	3	45	4		2CREG 010 003 100	1 X R0.3	1.2	10	50	4	
2CREG 005 0005 040	0.5 X R0.05	0.6	4	45	4		2CREG 010 003 120	1 X R0.3	1.2	12	50	4	
2CREG 005 0005 050	0.5 X R0.05	0.6	5	45	4		2CREG 010 003 160	1 X R0.3	1.2	16	50	4	
2CREG 005 0005 060	0.5 X R0.05	0.6	6	45	4		2CREG 010 003 200	1 X R0.3	1.2	20	50	4	
2CREG 005 001 010	0.5 X R0.1	0.6	1	45	4		2CREG 012 001 040	1.2 X R0.1	1.4	4	45	4	
2CREG 005 001 015	0.5 X R0.1	0.6	1.5	45	4		2CREG 012 001 060	1.2 X R0.1	1.4	6	45	4	
2CREG 005 001 020	0.5 X R0.1	0.6	2	45	4		2CREG 012 001 080	1.2 X R0.1	1.4	8	45	4	
2CREG 005 001 025	0.5 X R0.1	0.6	2.5	45	4		2CREG 012 001 100	1.2 X R0.1	1.4	10	50	4	
2CREG 005 001 030	0.5 X R0.1	0.6	3	45	4		2CREG 012 001 120	1.2 X R0.1	1.4	12	50	4	
2CREG 005 001 040	0.5 X R0.1	0.6	4	45	4		2CREG 012 001 160	1.2 X R0.1	1.4	16	50	4	
2CREG 005 001 050	0.5 X R0.1	0.6	5	45	4		2CREG 012 001 200	1.2 X R0.1	1.4	20	50	4	
2CREG 005 001 060	0.5 X R0.1	0.6	6	45	4		2CREG 012 002 040	1.2 X R0.2	1.4	4	45	4	
2CREG 006 0005 020	0.6 X R0.05	0.7	2	45	4		2CREG 012 002 060	1.2 X R0.2	1.4	6	45	4	
2CREG 006 0005 030	0.6 X R0.05	0.7	3	45	4		2CREG 012 002 080	1.2 X R0.2	1.4	8	45	4	
2CREG 006 0005 040	0.6 X R0.05	0.7	4	45	4		2CREG 012 002 100	1.2 X R0.2	1.4	10	50	4	
2CREG 006 0005 060	0.6 X R0.05	0.7	6	45	4		2CREG 012 002 120	1.2 X R0.2	1.4	12	50	4	
2CREG 006 0005 080	0.6 X R0.05	0.7	8	45	4		2CREG 012 002 160	1.2 X R0.2	1.4	16	50	4	
2CREG 006 001 020	0.6 X R0.1	0.7	2	45	4		2CREG 012 002 200	1.2 X R0.2	1.4	20	50	4	
2CREG 006 001 030	0.6 X R0.1	0.7	3	45	4		2CREG 012 003 040	1.2 X R0.3	1.4	4	45	4	
2CREG 006 001 040	0.6 X R0.1	0.7	4	45	4		2CREG 012 003 060	1.2 X R0.3	1.4	6	45	4	
2CREG 006 001 060	0.6 X R0.1	0.7	6	45	4		2CREG 012 003 080	1.2 X R0.3	1.4	8	45	4	
2CREG 006 001 080	0.6 X R0.1	0.7	8	45	4		2CREG 012 003 100	1.2 X R0.3	1.4	10	50	4	
2CREG 007 001 020	0.7 X R0.1	0.8	2	45	4		2CREG 012 003 120	1.2 X R0.3	1.4	12	50	4	
2CREG 007 001 040	0.7 X R0.1	0.8	4	45	4		2CREG 012 003 160	1.2 X R0.3	1.4	16	50	4	
2CREG 007 001 060	0.7 X R0.1	0.8	6	45	4		2CREG 012 003 200	1.2 X R0.3	1.4	20	50	4	
2CREG 008 001 020	0.8 X R0.1	0.9	2	45	4		2CREG 015 001 040	1.5 X R0.1	1.8	4	45	4	
2CREG 008 001 040	0.8 X R0.1	0.9	4	45	4		2CREG 015 001 060	1.5 X R0.1	1.8	6	45	4	
2CREG 008 001 060	0.8 X R0.1	0.9	6	45	4		2CREG 015 001 080	1.5 X R0.1	1.8	8	45	4	
2CREG 008 001 080	0.8 X R0.1	0.9	8	45	4		2CREG 015 001 100	1.5 X R0.1	1.8	10	50	4	
2CREG 008 002 020	0.8 X R0.2	0.9	2	45	4		2CREG 015 001 120	1.5 X R0.1	1.8	12	50	4	

단위 : mm

Order Number	날경 D×R	날장 Length of cut L1	유효장 Effective Length L2	전장 Overall Length L	샙크 Dia d	비고	Order Number	날경 D×R	날장 Length of cut L1	유효장 Effective Length L2	전장 Overall Length L	샙크 Dia d	비고
2CREG 015 001 160	1.5 X R0.1	1.8	16	50	4		2CREG 025 001 160	2.5 X R0.1	3	16	50	4	
2CREG 015 001 200	1.5 X R0.1	1.8	20	50	4		2CREG 025 001 200	2.5 X R0.1	3	20	50	4	
2CREG 015 001 220	1.5 X R0.1	1.8	22	60	4		2CREG 025 001 250	2.5 X R0.1	3	25	60	4	
2CREG 015 001 250	1.5 X R0.1	1.8	25	60	4		2CREG 025 001 300	2.5 X R0.1	3	30	70	4	
2CREG 015 002 040	1.5 X R0.2	1.8	4	45	4		2CREG 025 002 100	2.5 X R0.2	3	10	50	4	
2CREG 015 002 060	1.5 X R0.2	1.8	6	45	4		2CREG 025 002 160	2.5 X R0.2	3	16	50	4	
2CREG 015 002 080	1.5 X R0.2	1.8	8	45	4		2CREG 025 002 200	2.5 X R0.2	3	20	50	4	
2CREG 015 002 100	1.5 X R0.2	1.8	10	50	4		2CREG 025 002 250	2.5 X R0.2	3	25	60	4	
2CREG 015 002 120	1.5 X R0.2	1.8	12	50	4		2CREG 025 002 300	2.5 X R0.2	3	30	70	4	
2CREG 015 002 160	1.5 X R0.2	1.8	16	50	4		2CREG 025 003 100	2.5 X R0.3	3	10	50	4	
2CREG 015 002 200	1.5 X R0.2	1.8	20	50	4		2CREG 025 003 160	2.5 X R0.3	3	16	50	4	
2CREG 015 002 220	1.5 X R0.2	1.8	22	60	4		2CREG 025 003 200	2.5 X R0.3	3	20	50	4	
2CREG 015 002 250	1.5 X R0.2	1.8	25	60	4		2CREG 025 003 250	2.5 X R0.3	3	25	60	4	
2CREG 015 003 040	1.5 X R0.3	1.8	4	45	4		2CREG 025 003 300	2.5 X R0.3	3	30	70	4	
2CREG 015 003 060	1.5 X R0.3	1.8	6	45	4		2CREG 025 005 100	2.5 X R0.5	3	10	50	4	
2CREG 015 003 080	1.5 X R0.3	1.8	8	45	4		2CREG 025 005 160	2.5 X R0.5	3	16	50	4	
2CREG 015 003 100	1.5 X R0.3	1.8	10	50	4		2CREG 025 005 200	2.5 X R0.5	3	20	50	4	
2CREG 015 003 120	1.5 X R0.3	1.8	12	50	4		2CREG 025 005 250	2.5 X R0.5	3	25	60	4	
2CREG 015 003 160	1.5 X R0.3	1.8	16	50	4		2CREG 025 005 300	2.5 X R0.5	3	30	70	4	
2CREG 015 003 200	1.5 X R0.3	1.8	20	50	4		2CREG 030 001 100	3 X R0.1	3.6	10	50	6	
2CREG 015 003 220	1.5 X R0.3	1.8	22	60	4		2CREG 030 001 120	3 X R0.1	3.6	12	50	6	
2CREG 015 003 250	1.5 X R0.3	1.8	25	60	4		2CREG 030 001 160	3 X R0.1	3.6	16	55	6	
2CREG 015 005 040	1.5 X R0.5	1.8	4	45	4		2CREG 030 001 200	3 X R0.1	3.6	20	60	6	
2CREG 015 005 060	1.5 X R0.5	1.8	6	45	4		2CREG 030 001 250	3 X R0.1	3.6	25	65	6	
2CREG 015 005 080	1.5 X R0.5	1.8	8	45	4		2CREG 030 001 300	3 X R0.1	3.6	30	70	6	
2CREG 015 005 100	1.5 X R0.5	1.8	10	50	4		2CREG 030 001 350	3 X R0.1	3.6	35	75	6	
2CREG 015 005 120	1.5 X R0.5	1.8	12	50	4		2CREG 030 001 400	3 X R0.1	3.6	40	80	6	
2CREG 015 005 160	1.5 X R0.5	1.8	16	50	4		2CREG 030 002 100	3 X R0.2	3.6	10	50	6	
2CREG 015 005 200	1.5 X R0.5	1.8	20	50	4		2CREG 030 002 120	3 X R0.2	3.6	12	50	6	
2CREG 015 005 220	1.5 X R0.5	1.8	22	60	4		2CREG 030 002 160	3 X R0.2	3.6	16	55	6	
2CREG 015 005 250	1.5 X R0.5	1.8	25	60	4		2CREG 030 002 200	3 X R0.2	3.6	20	60	6	
2CREG 020 001 060	2 X R0.1	2.4	6	45	4		2CREG 030 002 250	3 X R0.2	3.6	25	65	6	
2CREG 020 001 080	2 X R0.1	2.4	8	45	4		2CREG 030 002 300	3 X R0.2	3.6	30	70	6	
2CREG 020 001 100	2 X R0.1	2.4	10	50	4		2CREG 030 002 350	3 X R0.2	3.6	35	75	6	
2CREG 020 001 120	2 X R0.1	2.4	12	50	4		2CREG 030 002 400	3 X R0.2	3.6	40	80	6	
2CREG 020 001 160	2 X R0.1	2.4	16	50	4		2CREG 030 003 100	3 X R0.3	3.6	10	50	6	
2CREG 020 001 200	2 X R0.1	2.4	20	50	4		2CREG 030 003 120	3 X R0.3	3.6	12	50	6	
2CREG 020 001 250	2 X R0.1	2.4	25	60	4		2CREG 030 003 160	3 X R0.3	3.6	16	55	6	
2CREG 020 001 300	2 X R0.1	2.4	30	70	4		2CREG 030 003 200	3 X R0.3	3.6	20	60	6	
2CREG 020 002 060	2 X R0.2	2.4	6	45	4		2CREG 030 003 250	3 X R0.3	3.6	25	65	6	
2CREG 020 002 080	2 X R0.2	2.4	8	45	4		2CREG 030 003 300	3 X R0.3	3.6	30	70	6	
2CREG 020 002 100	2 X R0.2	2.4	10	50	4		2CREG 030 003 350	3 X R0.3	3.6	35	75	6	
2CREG 020 002 120	2 X R0.2	2.4	12	50	4		2CREG 030 003 400	3 X R0.3	3.6	40	80	6	
2CREG 020 002 160	2 X R0.2	2.4	16	50	4		2CREG 030 005 100	3 X R0.5	3.6	10	50	6	
2CREG 020 002 200	2 X R0.2	2.4	20	50	4		2CREG 030 005 120	3 X R0.5	3.6	12	50	6	
2CREG 020 002 250	2 X R0.2	2.4	25	60	4		2CREG 030 005 160	3 X R0.5	3.6	16	55	6	
2CREG 020 002 300	2 X R0.2	2.4	30	70	4		2CREG 030 005 200	3 X R0.5	3.6	20	60	6	
2CREG 020 003 060	2 X R0.3	2.4	6	45	4		2CREG 030 005 250	3 X R0.5	3.6	25	65	6	
2CREG 020 003 080	2 X R0.3	2.4	8	45	4		2CREG 030 005 300	3 X R0.5	3.6	30	70	6	
2CREG 020 003 100	2 X R0.3	2.4	10	50	4		2CREG 030 005 350	3 X R0.5	3.6	35	75	6	
2CREG 020 003 120	2 X R0.3	2.4	12	50	4		2CREG 030 005 400	3 X R0.5	3.6	40	80	6	
2CREG 020 003 160	2 X R0.3	2.4	16	50	4		2CREG 030 010 100	3 X R1	3.6	10	50	6	
2CREG 020 003 200	2 X R0.3	2.4	20	50	4		2CREG 030 010 120	3 X R1	3.6	12	50	6	
2CREG 020 003 250	2 X R0.3	2.4	25	60	4		2CREG 030 010 160	3 X R1	3.6	16	55	6	
2CREG 020 003 300	2 X R0.3	2.4	30	70	4		2CREG 030 010 200	3 X R1	3.6	20	60	6	
2CREG 020 005 060	2 X R0.5	2.4	6	45	4		2CREG 030 010 250	3 X R1	3.6	25	65	6	
2CREG 020 005 080	2 X R0.5	2.4	8	45	4		2CREG 030 010 300	3 X R1	3.6	30	70	6	
2CREG 020 005 100	2 X R0.5	2.4	10	50	4		2CREG 030 010 350	3 X R1	3.6	35	75	6	
2CREG 020 005 120	2 X R0.5	2.4	12	50	4		2CREG 030 010 400	3 X R1	3.6	40	80	6	
2CREG 020 005 160	2 X R0.5	2.4	16	50	4		2CREG 040 001 050	4 X R0.1	4.8	12	50	4	
2CREG 020 005 200	2 X R0.5	2.4	20	50	4		2CREG 040 001 070	4 X R0.1	4.8	20	70	4	
2CREG 020 005 250	2 X R0.5	2.4	25	60	4		2CREG 040 001 120	4 X R0.1	4.8	12	50	6	
2CREG 020 005 300	2 X R0.5	2.4	30	70	4		2CREG 040 001 160	4 X R0.1	4.8	16	55	6	
2CREG 025 001 100	2.5 X R0.1	3	10	50	4		2CREG 040 001 200	4 X R0.1	4.8	20	60	6	

G series

# 2CREG 2 Flutes Rib Corner Radius End Mills for Multi Purpose

## 2날 범용 리브 코너 레디우스 엔드밀

단위 : mm

Order Number	날경 Diameter D×R	날장 Length of cut L1	유효장 Effective Length L2	전장 Overall Length L	생크 Shank Dia d	비고	Order Number	날경 Diameter D×R	날장 Length of cut L1	유효장 Effective Length L2	전장 Overall Length L	생크 Shank Dia d	비고
2CREG 040 001 250	4 X R0.1	4.8	25	65	6		2CREG 050 010 500	5 X R1	6	50	100	6	
2CREG 040 001 300	4 X R0.1	4.8	30	70	6		2CREG 060 001 200	6 X R0.1	7	20	60	6	
2CREG 040 001 350	4 X R0.1	4.8	35	75	6		2CREG 060 001 400	6 X R0.1	7	40	90	6	
2CREG 040 001 400	4 X R0.1	4.8	40	80	6		2CREG 060 002 200	6 X R0.2	7	20	60	6	
2CREG 040 001 450	4 X R0.1	4.8	45	90	6		2CREG 060 002 400	6 X R0.2	7	40	90	6	
2CREG 040 001 500	4 X R0.1	4.8	50	100	6		2CREG 060 003 200	6 X R0.3	7	20	60	6	
2CREG 040 002 050	4 X R0.2	4.8	12	50	4		2CREG 060 003 400	6 X R0.3	7	40	90	6	
2CREG 040 002 070	4 X R0.2	4.8	20	70	4		2CREG 060 005 200	6 X R0.5	7	20	60	6	
2CREG 040 002 120	4 X R0.2	4.8	12	50	6		2CREG 060 005 400	6 X R0.5	7	40	90	6	
2CREG 040 002 160	4 X R0.2	4.8	16	55	6		2CREG 060 010 200	6 X R1	7	20	60	6	
2CREG 040 002 200	4 X R0.2	4.8	20	60	6		2CREG 060 010 400	6 X R1	7	40	90	6	
2CREG 040 002 250	4 X R0.2	4.8	25	65	6		2CREG 060 015 200	6 X R1.5	7	20	60	6	
2CREG 040 002 300	4 X R0.2	4.8	30	70	6		2CREG 060 015 400	6 X R1.5	7	40	90	6	
2CREG 040 002 350	4 X R0.2	4.8	35	75	6		2CREG 080 002 220	8 X R0.2	9	22	65	8	
2CREG 040 002 400	4 X R0.2	4.8	40	80	6		2CREG 080 002 400	8 X R0.2	9	40	100	8	
2CREG 040 002 450	4 X R0.2	4.8	45	90	6		2CREG 080 003 220	8 X R0.3	9	22	65	8	
2CREG 040 002 500	4 X R0.2	4.8	50	100	6		2CREG 080 003 400	8 X R0.3	9	40	100	8	
2CREG 040 003 050	4 X R0.3	4.8	12	50	4		2CREG 080 005 220	8 X R0.5	9	22	65	8	
2CREG 040 003 070	4 X R0.3	4.8	20	70	4		2CREG 080 005 400	8 X R0.5	9	40	100	8	
2CREG 040 003 120	4 X R0.3	4.8	12	50	6		2CREG 080 010 220	8 X R1	9	22	65	8	
2CREG 040 003 160	4 X R0.3	4.8	16	55	6		2CREG 080 010 400	8 X R1	9	40	100	8	
2CREG 040 003 200	4 X R0.3	4.8	20	60	6		2CREG 080 015 220	8 X R1.5	9	22	65	8	
2CREG 040 003 250	4 X R0.3	4.8	25	65	6		2CREG 080 015 400	8 X R1.5	9	40	100	8	
2CREG 040 003 300	4 X R0.3	4.8	30	70	6		2CREG 100 002 240	10 X R0.2	11	24	70	10	
2CREG 040 003 350	4 X R0.3	4.8	35	75	6		2CREG 100 002 450	10 X R0.2	11	45	100	10	
2CREG 040 003 400	4 X R0.3	4.8	40	80	6		2CREG 100 003 240	10 X R0.3	11	24	70	10	
2CREG 040 003 450	4 X R0.3	4.8	45	90	6		2CREG 100 003 450	10 X R0.3	11	45	100	10	
2CREG 040 003 500	4 X R0.3	4.8	50	100	6		2CREG 100 005 240	10 X R0.5	11	24	70	10	
2CREG 040 005 050	4 X R0.5	4.8	12	50	4		2CREG 100 005 450	10 X R0.5	11	45	100	10	
2CREG 040 005 070	4 X R0.5	4.8	20	70	4		2CREG 100 010 240	10 X R1	11	24	70	10	
2CREG 040 005 120	4 X R0.5	4.8	12	50	6		2CREG 100 010 450	10 X R1	11	45	100	10	
2CREG 040 005 160	4 X R0.5	4.8	16	55	6		2CREG 100 015 240	10 X R1.5	11	24	70	10	
2CREG 040 005 200	4 X R0.5	4.8	20	60	6		2CREG 100 015 450	10 X R1.5	11	45	100	10	
2CREG 040 005 250	4 X R0.5	4.8	25	65	6		2CREG 100 020 240	10 X R2	11	24	70	10	
2CREG 040 005 300	4 X R0.5	4.8	30	70	6		2CREG 100 020 450	10 X R2	11	45	100	10	
2CREG 040 005 350	4 X R0.5	4.8	35	75	6		2CREG 120 002 260	12 X R0.2	13	26	80	12	
2CREG 040 005 400	4 X R0.5	4.8	40	80	6		2CREG 120 002 500	12 X R0.2	13	50	110	12	
2CREG 040 005 450	4 X R0.5	4.8	45	90	6		2CREG 120 003 260	12 X R0.3	13	26	80	12	
2CREG 040 005 500	4 X R0.5	4.8	50	100	6		2CREG 120 003 500	12 X R0.3	13	50	110	12	
2CREG 040 010 050	4 X R1	4.8	12	50	4		2CREG 120 005 260	12 X R0.5	13	26	80	12	
2CREG 040 010 070	4 X R1	4.8	20	70	4		2CREG 120 005 500	12 X R0.5	13	50	110	12	
2CREG 040 010 120	4 X R1	4.8	12	50	6		2CREG 120 010 260	12 X R1	13	26	80	12	
2CREG 040 010 160	4 X R1	4.8	16	55	6		2CREG 120 010 500	12 X R1	13	50	110	12	
2CREG 040 010 200	4 X R1	4.8	20	60	6		2CREG 120 015 260	12 X R1.5	13	26	80	12	
2CREG 040 010 250	4 X R1	4.8	25	65	6		2CREG 120 015 500	12 X R1.5	13	50	110	12	
2CREG 040 010 300	4 X R1	4.8	30	70	6		2CREG 120 020 260	12 X R2	13	26	80	12	
2CREG 040 010 350	4 X R1	4.8	35	75	6		2CREG 120 020 500	12 X R2	13	50	110	12	
2CREG 040 010 400	4 X R1	4.8	40	80	6		2CREG 120 030 260	12 X R3	13	26	80	12	
2CREG 040 010 450	4 X R1	4.8	45	90	6		2CREG 120 030 500	12 X R3	13	50	110	12	
2CREG 040 010 500	4 X R1	4.8	50	100	6		2CREG 160 005 110	16 X R0.5	20	35	110	16	
2CREG 050 002 150	5 X R0.2	6	15	55	6		2CREG 160 005 160	16 X R0.5	20	35	160	16	
2CREG 050 002 250	5 X R0.2	6	25	70	6		2CREG 160 010 110	16 X R1	20	35	110	16	
2CREG 050 002 300	5 X R0.2	6	30	70	6		2CREG 160 010 160	16 X R1	20	35	160	16	
2CREG 050 002 400	5 X R0.2	6	40	80	6								
2CREG 050 002 500	5 X R0.2	6	50	100	6								
2CREG 050 005 150	5 X R0.5	6	15	55	6								
2CREG 050 005 250	5 X R0.5	6	25	70	6								
2CREG 050 005 300	5 X R0.5	6	30	70	6								
2CREG 050 005 400	5 X R0.5	6	40	80	6								
2CREG 050 005 500	5 X R0.5	6	50	100	6								
2CREG 050 010 150	5 X R1	6	15	55	6								
2CREG 050 010 250	5 X R1	6	25	70	6								
2CREG 050 010 300	5 X R1	6	30	70	6								
2CREG 050 010 400	5 X R1	6	40	80	6								

G series

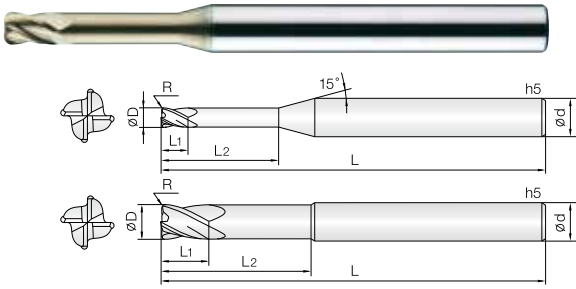

- 중저경도강(HRC52이하), 프리하든강 계열, 탄소강, 금형강 등 가공
- JCRO 코팅 처리하여 넓은 영역의 피삭재 가공에 적합합니다.
- 고정밀 공차 적용으로 초정밀 가공에 적합합니다.
- 코너R 형상을 날부치핑이 적도록 설계하였습니다.
- 다양한 코너R과 유효장으로 맞춤 가공이 가능합니다.
- 항절력이 높은 미립자 초경합금(0.5µm)을 채택, 엔드밀의 파손을 최소화

#### Endmills for various work materials (~HRC52), pre-hardened steels, carbon steels, mold steels

- Optimum for various work materials by JCRO coating.
- High precise edge tolerance.
- Designed for minimizing edge chipping by corner R shape.
- Various corner R and flute length for wide range application.
- Minimize fracturing by high TRS fine(0.5µm) WC grade.

G series



Condition	D Size	D Tolerance	Condition	D Size	D Tolerance
øD ≠ ød	ø1 ~ 12	+0 ~ -0.01mm	øD = ød	ø4 ~ 12	-0.005 ~ -0.015mm

단위 : mm

Order Number	날경 Diameter D×R	날장 Length of cut L1	유효장 Effective Length L2	전장 Overall Length L	샙크 Shank Dia d	비고	Order Number	날경 Diameter D×R	날장 Length of cut L1	유효장 Effective Length L2	전장 Overall Length L	샙크 Shank Dia d	비고
4CREG 010 0005 040	1 X R0.05	1.2	4	45	4		4CREG 015 001 080	1.5 X R0.1	1.8	8	45	4	
4CREG 010 0005 060	1 X R0.05	1.2	6	45	4		4CREG 015 001 100	1.5 X R0.1	1.8	10	50	4	
4CREG 010 0005 080	1 X R0.05	1.2	8	45	4		4CREG 015 001 120	1.5 X R0.1	1.8	12	50	4	
4CREG 010 0005 100	1 X R0.05	1.2	10	50	4		4CREG 015 001 160	1.5 X R0.1	1.8	16	50	4	
4CREG 010 0005 120	1 X R0.05	1.2	12	50	4		4CREG 015 001 200	1.5 X R0.1	1.8	20	50	4	
4CREG 010 0005 160	1 X R0.05	1.2	16	50	4		4CREG 015 001 220	1.5 X R0.1	1.8	22	60	4	
4CREG 010 0005 200	1 X R0.05	1.2	20	50	4		4CREG 015 001 250	1.5 X R0.1	1.8	25	60	4	
4CREG 010 001 040	1 X R0.1	1.2	4	45	4		4CREG 015 002 060	1.5 X R0.2	1.8	6	45	4	
4CREG 010 001 060	1 X R0.1	1.2	6	45	4		4CREG 015 002 080	1.5 X R0.2	1.8	8	45	4	
4CREG 010 001 080	1 X R0.1	1.2	8	45	4		4CREG 015 002 100	1.5 X R0.2	1.8	10	50	4	
4CREG 010 001 100	1 X R0.1	1.2	10	50	4		4CREG 015 002 120	1.5 X R0.2	1.8	12	50	4	
4CREG 010 001 120	1 X R0.1	1.2	12	50	4		4CREG 015 002 160	1.5 X R0.2	1.8	16	50	4	
4CREG 010 001 160	1 X R0.1	1.2	16	50	4		4CREG 015 002 200	1.5 X R0.2	1.8	20	50	4	
4CREG 010 001 200	1 X R0.1	1.2	20	50	4		4CREG 015 002 220	1.5 X R0.2	1.8	22	60	4	
4CREG 010 002 040	1 X R0.2	1.2	4	45	4		4CREG 015 002 250	1.5 X R0.2	1.8	25	60	4	
4CREG 010 002 060	1 X R0.2	1.2	6	45	4		4CREG 015 003 060	1.5 X R0.3	1.8	6	45	4	
4CREG 010 002 080	1 X R0.2	1.2	8	45	4		4CREG 015 003 080	1.5 X R0.3	1.8	8	45	4	
4CREG 010 002 100	1 X R0.2	1.2	10	50	4		4CREG 015 003 100	1.5 X R0.3	1.8	10	50	4	
4CREG 010 002 120	1 X R0.2	1.2	12	50	4		4CREG 015 003 120	1.5 X R0.3	1.8	12	50	4	
4CREG 010 002 160	1 X R0.2	1.2	16	50	4		4CREG 015 003 160	1.5 X R0.3	1.8	16	50	4	
4CREG 010 002 200	1 X R0.2	1.2	20	50	4		4CREG 015 003 200	1.5 X R0.3	1.8	20	50	4	
4CREG 010 003 040	1 X R0.3	1.2	4	45	4		4CREG 015 003 220	1.5 X R0.3	1.8	22	60	4	
4CREG 010 003 060	1 X R0.3	1.2	6	45	4		4CREG 015 003 250	1.5 X R0.3	1.8	25	60	4	
4CREG 010 003 080	1 X R0.3	1.2	8	45	4		4CREG 015 005 060	1.5 X R0.5	1.8	6	45	4	
4CREG 010 003 100	1 X R0.3	1.2	10	50	4		4CREG 015 005 080	1.5 X R0.5	1.8	8	45	4	
4CREG 010 003 120	1 X R0.3	1.2	12	50	4		4CREG 015 005 100	1.5 X R0.5	1.8	10	50	4	
4CREG 010 003 160	1 X R0.3	1.2	16	50	4		4CREG 015 005 120	1.5 X R0.5	1.8	12	50	4	
4CREG 010 003 200	1 X R0.3	1.2	20	50	4		4CREG 015 005 160	1.5 X R0.5	1.8	16	50	4	
4CREG 012 001 040	1.2 X R0.1	1.4	4	45	4		4CREG 015 005 200	1.5 X R0.5	1.8	20	50	4	
4CREG 012 001 060	1.2 X R0.1	1.4	6	45	4		4CREG 015 005 220	1.5 X R0.5	1.8	22	60	4	
4CREG 012 001 080	1.2 X R0.1	1.4	8	45	4		4CREG 015 005 250	1.5 X R0.5	1.8	25	60	4	
4CREG 012 001 100	1.2 X R0.1	1.4	10	50	4		4CREG 020 001 060	2 X R0.1	2.4	6	45	4	
4CREG 012 001 120	1.2 X R0.1	1.4	12	50	4		4CREG 020 001 080	2 X R0.1	2.4	8	45	4	
4CREG 012 001 160	1.2 X R0.1	1.4	16	50	4		4CREG 020 001 100	2 X R0.1	2.4	10	50	4	
4CREG 012 001 200	1.2 X R0.1	1.4	20	50	4		4CREG 020 001 120	2 X R0.1	2.4	12	50	4	
4CREG 012 002 040	1.2 X R0.2	1.4	4	45	4		4CREG 020 001 160	2 X R0.1	2.4	16	50	4	
4CREG 012 002 060	1.2 X R0.2	1.4	6	45	4		4CREG 020 001 200	2 X R0.1	2.4	20	50	4	
4CREG 012 002 080	1.2 X R0.2	1.4	8	45	4		4CREG 020 001 250	2 X R0.1	2.4	25	60	4	
4CREG 012 002 100	1.2 X R0.2	1.4	10	50	4		4CREG 020 001 300	2 X R0.1	2.4	30	70	4	
4CREG 012 002 120	1.2 X R0.2	1.4	12	50	4		4CREG 020 001 350	2 X R0.1	2.4	35	70	4	
4CREG 012 002 160	1.2 X R0.2	1.4	16	50	4		4CREG 020 002 060	2 X R0.2	2.4	6	45	4	
4CREG 012 002 200	1.2 X R0.2	1.4	20	50	4		4CREG 020 002 080	2 X R0.2	2.4	8	45	4	
4CREG 012 003 040	1.2 X R0.3	1.4	4	45	4		4CREG 020 002 100	2 X R0.2	2.4	10	50	4	
4CREG 012 003 060	1.2 X R0.3	1.4	6	45	4		4CREG 020 002 120	2 X R0.2	2.4	12	50	4	
4CREG 012 003 080	1.2 X R0.3	1.4	8	45	4		4CREG 020 002 160	2 X R0.2	2.4	16	50	4	
4CREG 012 003 100	1.2 X R0.3	1.4	10	50	4		4CREG 020 002 200	2 X R0.2	2.4	20	50	4	
4CREG 012 003 120	1.2 X R0.3	1.4	12	50	4		4CREG 020 002 250	2 X R0.2	2.4	25	60	4	
4CREG 012 003 160	1.2 X R0.3	1.4	16	50	4		4CREG 020 002 300	2 X R0.2	2.4	30	70	4	
4CREG 012 003 200	1.2 X R0.3	1.4	20	50	4		4CREG 020 002 350	2 X R0.2	2.4	35	70	4	
4CREG 015 001 060	1.5 X R0.1	1.8	6	45	4		4CREG 020 003 060	2 X R0.3	2.4	6	45	4	





단위 : mm

Order Number	날경 Diameter D×R	날장 Length of cut L1	유효장 Effective Length L2	전장 Overall Length L	샙크 Shank Dia d	비고	Order Number	날경 Diameter D×R	날장 Length of cut L1	유효장 Effective Length L2	전장 Overall Length L	샙크 Shank Dia d	비고
4CREG 040 010 350	4 X R1	4.8	35	75	6		4CREG 120 010 260	12 X R1	13	26	80	12	
4CREG 040 010 400	4 X R1	4.8	40	80	6		4CREG 120 010 400	12 X R1	13	40	110	12	
4CREG 040 010 450	4 X R1	4.8	45	90	6		4CREG 120 015 260	12 X R1.5	13	26	80	12	
4CREG 040 010 500	4 X R1	4.8	50	100	6		4CREG 120 015 400	12 X R1.5	13	40	110	12	
4CREG 050 001 150	5 X R0.1	6	15	55	6		4CREG 120 020 260	12 X R2	13	26	80	12	
4CREG 050 001 300	5 X R0.1	6	30	70	6		4CREG 120 030 260	12 X R3	13	26	80	12	
4CREG 050 001 400	5 X R0.1	6	40	80	6								
4CREG 050 001 500	5 X R0.1	6	50	100	6								
4CREG 050 002 150	5 X R0.2	6	15	55	6								
4CREG 050 002 300	5 X R0.2	6	30	70	6								
4CREG 050 002 400	5 X R0.2	6	40	80	6								
4CREG 050 002 500	5 X R0.2	6	50	100	6								
4CREG 050 003 150	5 X R0.3	6	15	55	6								
4CREG 050 003 300	5 X R0.3	6	30	70	6								
4CREG 050 003 400	5 X R0.3	6	40	80	6								
4CREG 050 003 500	5 X R0.3	6	50	100	6								
4CREG 050 005 150	5 X R0.5	6	15	55	6								
4CREG 050 005 300	5 X R0.5	6	30	70	6								
4CREG 050 005 400	5 X R0.5	6	40	80	6								
4CREG 050 005 500	5 X R0.5	6	50	100	6								
4CREG 050 010 150	5 X R1	6	15	55	6								
4CREG 050 010 300	5 X R1	6	30	70	6								
4CREG 050 010 400	5 X R1	6	40	80	6								
4CREG 050 010 500	5 X R1	6	50	100	6								
4CREG 060 001 200	6 X R0.1	7	20	60	6								
4CREG 060 001 400	6 X R0.1	7	40	80	6								
4CREG 060 001 500	6 X R0.1	7	50	100	6								
4CREG 060 002 200	6 X R0.2	7	20	60	6								
4CREG 060 002 400	6 X R0.2	7	40	80	6								
4CREG 060 002 500	6 X R0.2	7	50	100	6								
4CREG 060 003 200	6 X R0.3	7	20	60	6								
4CREG 060 003 400	6 X R0.3	7	40	80	6								
4CREG 060 003 500	6 X R0.3	7	50	100	6								
4CREG 060 005 200	6 X R0.5	7	20	60	6								
4CREG 060 005 400	6 X R0.5	7	40	80	6								
4CREG 060 005 500	6 X R0.5	7	50	100	6								
4CREG 060 010 200	6 X R1	7	20	60	6								
4CREG 060 010 400	6 X R1	7	40	80	6								
4CREG 060 010 500	6 X R1	7	50	100	6								
4CREG 060 015 200	6 X R1.5	7	20	60	6								
4CREG 060 015 400	6 X R1.5	7	40	80	6								
4CREG 060 015 500	6 X R1.5	7	50	100	6								
4CREG 080 002 220	8 X R0.2	9	22	65	8								
4CREG 080 003 220	8 X R0.3	9	22	65	8								
4CREG 080 005 220	8 X R0.5	9	22	65	8								
4CREG 080 005 400	8 X R0.5	9	40	100	8								
4CREG 080 010 220	8 X R1	9	22	65	8								
4CREG 080 010 400	8 X R1	9	40	100	8								
4CREG 080 015 220	8 X R1.5	9	22	65	8								
4CREG 080 015 400	8 X R1.5	9	40	100	8								
4CREG 080 020 220	8 X R2	9	22	65	8								
4CREG 100 002 240	10 X R0.2	11	24	70	10								
4CREG 100 003 240	10 X R0.3	11	24	70	10								
4CREG 100 005 240	10 X R0.5	11	24	70	10								
4CREG 100 005 400	10 X R0.5	11	40	100	10								
4CREG 100 010 240	10 X R1	11	24	70	10								
4CREG 100 010 400	10 X R1	11	40	100	10								
4CREG 100 015 240	10 X R1.5	11	24	70	10								
4CREG 100 015 400	10 X R1.5	11	40	100	10								
4CREG 100 020 240	10 X R2	11	24	70	10								
4CREG 100 025 240	10 X R2.5	11	24	70	10								
4CREG 120 003 260	12 X R0.3	13	26	80	12								
4CREG 120 005 260	12 X R0.5	13	26	80	12								
4CREG 120 005 400	12 X R0.5	13	40	110	12								

G series



단위 : mm

Order Number	날경 Diameter D × R	날장 Length of cut L1	전장 Overall Length L	셱크 Shank Dia d	비고	Order Number	날경 Diameter D × R	날장 Length of cut L1	전장 Overall Length L	셱크 Shank Dia d	비고
2NCRG 100 005 130	10 X R0.5	22	130	10							
2NCRG 100 010 075	10 X R1	19	75	10							
2NCRG 100 010 100	10 X R1	22	100	10							
2NCRG 100 010 130	10 X R1	22	130	10							
2NCRG 100 015 075	10 X R1.5	19	75	10							
2NCRG 100 015 100	10 X R1.5	22	100	10							
2NCRG 100 015 130	10 X R1.5	22	130	10							
2NCRG 100 020 075	10 X R2	19	75	10							
2NCRG 100 020 100	10 X R2	22	100	10							
2NCRG 100 025 100	10 X R2.5	22	100	10							
2NCRG 100 030 100	10 X R3	22	100	10							
2NCRG 100 040 100	10 X R4	22	100	10							
2NCRG 120 001 080	12 X R0.1	22	80	12							
2NCRG 120 001 110	12 X R0.1	26	110	12							
2NCRG 120 002 080	12 X R0.2	22	80	12							
2NCRG 120 002 110	12 X R0.2	26	110	12							
2NCRG 120 003 080	12 X R0.3	22	80	12							
2NCRG 120 003 110	12 X R0.3	26	110	12							
2NCRG 120 005 080	12 X R0.5	22	80	12							
2NCRG 120 005 110	12 X R0.5	26	110	12							
2NCRG 120 005 130	12 X R0.5	26	130	12							
2NCRG 120 010 080	12 X R1	22	80	12							
2NCRG 120 010 110	12 X R1	26	110	12							
2NCRG 120 010 130	12 X R1	26	130	12							
2NCRG 120 015 080	12 X R1.5	22	80	12							
2NCRG 120 015 110	12 X R1.5	26	110	12							
2NCRG 120 015 130	12 X R1.5	26	130	12							
2NCRG 120 020 080	12 X R2	22	80	12							
2NCRG 120 020 110	12 X R2	26	110	12							
2NCRG 120 020 130	12 X R2	26	130	12							
2NCRG 120 025 110	12 X R2.5	26	110	12							
2NCRG 120 030 110	12 X R3	26	110	12							
2NCRG 120 040 110	12 X R4	26	110	12							
2NCRG 120 050 110	12 X R5	26	110	12							



단위 : mm

Order Number	날경 Diameter D × R	날장 Length of cut L1	전장 Overall Length L	생크 Shank Dia d	비고	Order Number	날경 Diameter D × R	날장 Length of cut L1	전장 Overall Length L	생크 Shank Dia d	비고
4NCRG 120 003 080	12 X R0.3	22	80	12							
4NCRG 120 003 110	12 X R0.3	26	110	12							
4NCRG 120 005 080	12 X R0.5	22	80	12							
4NCRG 120 005 110	12 X R0.5	26	110	12							
4NCRG 120 005 130	12 X R0.5	26	130	12							
4NCRG 120 010 080	12 X R1	22	80	12							
4NCRG 120 010 110	12 X R1	26	110	12							
4NCRG 120 010 130	12 X R1	26	130	12							
4NCRG 120 015 080	12 X R1.5	22	80	12							
4NCRG 120 015 110	12 X R1.5	26	110	12							
4NCRG 120 015 130	12 X R1.5	26	130	12							
4NCRG 120 020 080	12 X R2	22	80	12							
4NCRG 120 020 110	12 X R2	26	110	12							
4NCRG 120 020 130	12 X R2	26	130	12							
4NCRG 120 025 080	12 X R2.5	22	80	12							
4NCRG 120 025 110	12 X R2.5	26	110	12							
4NCRG 120 025 130	12 X R2.5	26	130	12							
4NCRG 120 030 080	12 X R3	22	80	12							
4NCRG 120 030 110	12 X R3	26	110	12							
4NCRG 120 030 130	12 X R3	26	130	12							
4NCRG 120 035 110	12 X R3.5	26	110	12							
4NCRG 120 040 110	12 X R4	26	110	12							
4NCRG 160 005 110	16 X R0.5	35	110	16							
4NCRG 160 005 160	16 X R0.5	35	160	16							
4NCRG 160 010 110	16 X R1	35	110	16							
4NCRG 160 010 160	16 X R1	35	160	16							

### 3&4날 범용 라핑 엔드밀

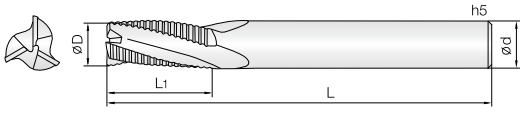

- **공구강, 합금강 및 고경도 일반강 향삭가공 엔드밀**
- JCRO 코팅 처리하여 다양한 피삭재 가공시 인선부에 스트레스가 적으며, 내마모성 또한 향상됩니다.
- 뛰어난 칩배출력으로 가공시간을 단축하였습니다.
- 고속가공으로 작업의 효율성을 극대화합니다.
- 항절력이 높은 미립자 초경합금을 채택하여, 엔드밀의 파손을 최소화 하였습니다.

- **Roughing Endmills for tool steels, alloy steels**
- JCRO coating provides wear resistance improvement as well as avoid edge stress in various applications.
- Reduce machining time by excellent chip control.
- Maximize work efficiency by high speed machining.
- Minimize fracturing at high feed by high TRS fine WC grade.



D Size	D Tolerance
∅ 4 ~ 9	-0.02 ~ -0.04mm
∅ 10 ~ 20	-0.02 ~ -0.05mm

단위 : mm

Order Number	날경 Diameter D	날장 Length of cut L1	전장 Overall Length L	샙크 Shank Dia d	비고	Order Number	날경 Diameter D	날장 Length of cut L1	전장 Overall Length L	샙크 Shank Dia d	비고
New 3ROUG 025 050 S06	2.5	5	45	6							
New 3ROUG 030 080 S06	3	8	45	6							
3ROUG 040 100 S06	4	10	50	6							
3ROUG 050 130 S06	5	13	50	6							
3ROUG 060 100 050	6	10	50	6							
3ROUG 060 150 055	6	15	55	6							
3ROUG 060 200 060	6	20	60	6							
3ROUG 070 180 S08	7	18	65	8							
3ROUG 080 120 060	8	12	60	8							
3ROUG 080 190 065	8	19	65	8							
3ROUG 080 250 070	8	25	70	8							
4ROUG 090 220 S10	9	22	70	10							
4ROUG 100 150 070	10	15	70	10							
4ROUG 100 220 070	10	22	70	10							
4ROUG 100 300 080	10	30	80	10							
4ROUG 110 270 S12	11	27	80	12							
4ROUG 120 200 075	12	20	75	12							
4ROUG 120 260 080	12	26	80	12							
4ROUG 120 350 090	12	35	90	12							
4ROUG 160 320 090	16	32	90	16							
4ROUG 160 400 100	16	40	100	16							
4ROUG 200 380 110	20	38	110	20							
4ROUG 200 500 110	20	50	110	20							

### 3&4날 범용 45°헬릭스 파인피치형 라핑 엔드밀

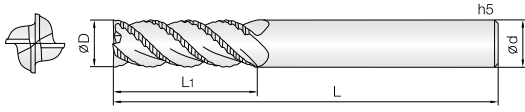

- 합금강, SUS계열, 인코넬, 일반구조강 등 다양한 난삭재의 황삭가공
- JCRO 코팅 처리하여 다양한 피삭재 가공시 인선부에 스트레스가 적으며, 내마모성 또한 향상됩니다.
- 45°헬릭스 적용으로 절삭 저항이 감소되어 장시간 가공에 적합합니다.
- 파인피치 형상 채택으로 고속, 황삭가공 작업에 적합합니다.

**Roughing Endmills for hard to cut materials, alloy steels, SUS, Inconel and structural steels**

- JCRO coating provides wear resistance improvement as well as avoid edge stress in various applications.
- Long tool life with low cutting force by 45° degree helix design.
- Fine pitch shape design for high speed roughing application.

G series

3

4

WC  
미립자

JCRO  
Coating

45°  
Helix Angle

Shield Edge  
464P

CUTTING  
DATA

D Size	D Tolerance
∅4 ~ 9	-0.02 ~ -0.04mm
∅10 ~ 20	-0.02 ~ -0.05mm

단위 : mm

Order Number	날경 Diameter D	날장 Length of cut L1	전장 Overall Length L	생크 Shank Dia d	비고	Order Number	날경 Diameter D	날장 Length of cut L1	전장 Overall Length L	생크 Shank Dia d	비고
3HROUG 040 100 S06	4	10	50	6							
3HROUG 050 130 S06	5	13	50	6							
3HROUG 060 100 050	6	10	50	6							
3HROUG 060 160 055	6	16	55	6							
3HROUG 060 200 060	6	20	60	6							
3HROUG 070 180 S08	7	18	65	8							
3HROUG 080 120 060	8	12	60	8							
3HROUG 080 190 065	8	19	65	8							
3HROUG 080 250 070	8	25	70	8							
4HROUG 090 220 S10	9	22	70	10							
4HROUG 100 150 070	10	15	70	10							
4HROUG 100 220 070	10	22	70	10							
4HROUG 100 300 080	10	30	80	10							
4HROUG 110 270 S12	11	27	80	12							
4HROUG 120 200 075	12	20	75	12							
4HROUG 120 250 080	12	25	80	12							
4HROUG 120 350 090	12	35	90	12							
4HROUG 160 320 090	16	32	90	16							
4HROUG 160 400 110	16	40	110	16							
4HROUG 200 380 110	20	38	110	20							
4HROUG 200 500 120	20	50	120	20							



## 4날 고능률 범용 볼 엔드밀

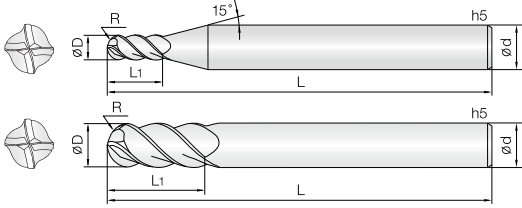

- 중저경도강(HRc 42이하), 연강, 주철, SUS계열 가공 엔드밀
- HR코팅 처리하여 다양한 피삭재 가공시 인선부에 스트레스가 적으며 내마모성 또한 향상 됩니다.
- 부등분할 볼방식과 가변 헬릭스 인선설계로 채터링이 더욱 감소 하였습니다.
- 4날 적용과 깊은 포켓으로 칩배출이 원활하며, 피삭재 면조도가 우수합니다.

**• Mid-low hardened steels (~HRc42), Mild steels, Cast irons, SUS**

- HR coating reduces stress of flute and enhances wear resistance.
- Unequal pitch Ball design and helix enable decrease of chattering.
- 4flutes and deep pocket enable chip evacuation and increase surface roughness.

4

WC  
미립자

HR  
Coating

R

R

R

35°/38°  
Helix Angle

CUTTING  
DATA

0.5 ~ 2.5R
3 ~ 6R
8 ~ 12.5R
Ø1 ~ 25
465P

Condition	D Size	D Tolerance
ØD ≠ Ød	Ø1 ~ 6	+0 ~ -0.01mm
	Ø8 ~ 25	+0 ~ -0.015mm

Condition	D Size	D Tolerance
ØD = Ød	Ø4 ~ 6	-0.005 ~ -0.015mm
	Ø8 ~ 12	-0.01 ~ -0.025mm
	Ø16 ~ 25	-0.015 ~ -0.03mm

단위 : mm

Order Number	날경 Diameter R × D	날장 Length of cut L1	전장 Overall Length L	생크 Shank Dia d	비고
4VSB 010 025 S06	0.5R X 1	2.5	50	6	
4VSB 012 030 S06	0.6R X 1.2	3	50	6	
4VSB 015 040 S06	0.75R X 1.5	4	50	6	
4VSB 020 050 S06	1R X 2	5	50	6	
4VSB 025 060 S06	1.25R X 2.5	6	50	6	
4VSB 030 060 S03	1.5R X 3	6	50	3	
4VSB 030 080 S06	1.5R X 3	8	50	6	
4VSB 040 080 S04	2R X 4	8	50	4	
4VSB 040 100 S06	2R X 4	10	50	6	
4VSB 050 150 S06	2.5R X 5	15	60	6	
4VSB 060 150 S06	3R X 6	15	60	6	
4VSB 060 150 090	3R X 6	15	90	6	
4VSB 080 200 S08	4R X 8	20	70	8	
4VSB 080 200 100	4R X 8	20	100	8	
4VSB 100 250 S10	5R X 10	25	75	10	
4VSB 100 250 100	5R X 10	25	100	10	
4VSB 120 300 S12	6R X 12	30	80	12	
4VSB 120 300 120	6R X 12	30	120	12	
4VSB 160 400 S16	8R X 16	40	100	16	
4VSB 160 400 130	8R X 16	40	130	16	
4VSB 200 450 S20	10R X 20	45	100	20	
4VSB 200 450 150	10R X 20	45	150	20	
4VSB 250 500 S25	12.5R X 25	50	125	25	
4VSB 250 500 160	12.5R X 25	50	160	25	

Order Number	날경 Diameter R × D	날장 Length of cut L1	전장 Overall Length L	생크 Shank Dia d	비고

V series





# 4SLE 4 Flutes High Speed Slotting End Mills for SUS

## 4날 고속 슬로팅 가공 엔드밀

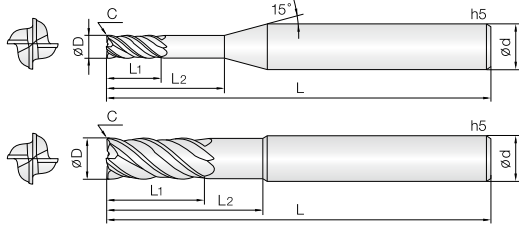

- 합금강, SUS계열, 인코넬, 일반구조강 등 다양한 난삭재 정삭, 황삭 가공
  - 슬로팅 가공시 2층의 옆날 홈으로 칩 배출이 우수하며, 두터운 2층의 코어는 흔들림 없는 가공을 구현합니다.
  - TISIN-R 코팅 처리하여 다양한 피삭재 가공시 인선부에 스트레스가 적으며, 내마모성 또한 향상됩니다.
  - 항절력이 높은 미립자 초경합금(0.5µm)을 채택, 엔드밀의 파손을 최소화.
- Endmills for finishing and roughing of alloy steels, SUS, Inconel, Mild steels and various hard-to-cut materials.
  - Chip emission is excellent for slotting, and thick double core designed enables continuous machining without chattering.
  - Minimize fracturing by high TRS fine(0.5µm) WC grade.
  - TISIN-R coating provides wear resistance improvement as well as avoid edge stress in various applications.

Condition	D Size	D Tolerance	Condition	D Size	D Tolerance
ØD ≠ Ød	Ø1 ~ 6	+0 ~ -0.01mm	ØD = Ød	Ø6	-0.005 ~ -0.015mm
	Ø8 ~ 20	+0 ~ -0.015mm		Ø8 ~ 12	-0.01 ~ -0.025mm
				Ø14 ~ 20	-0.015 ~ -0.03mm

단위 : mm

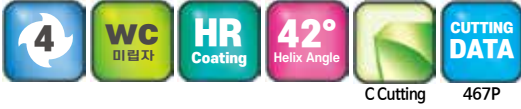

Order Number	날경 Diameter D	날장 Length of cut L1	면취량 Chamfer C	유효장 Effective Length L2	전장 Overall Length L	샙크 Dia d	비고
New 4SLE 010 030 S04	1	3	0.02	-	50	4	
New 4SLE 010 060 S04	1	3	0.02	6	60	4	
New 4SLE 010 080 S04	1	3	0.02	8	60	4	
New 4SLE 010 100 S04	1	3	0.02	10	60	4	
New 4SLE 015 040 S04	1.5	4	0.03	-	50	4	
New 4SLE 015 060 S04	1.5	4	0.03	6	60	4	
New 4SLE 015 080 S04	1.5	4	0.03	8	60	4	
New 4SLE 015 100 S04	1.5	4	0.03	10	60	4	
New 4SLE 015 120 S04	1.5	4	0.03	12	60	4	
New 4SLE 020 060 S04	2	6	0.04	-	50	4	
New 4SLE 020 080 S04	2	6	0.04	8	60	4	
New 4SLE 020 100 S04	2	6	0.04	10	60	4	
New 4SLE 020 120 S04	2	6	0.04	12	60	4	
New 4SLE 020 160 S04	2	6	0.04	16	60	4	
New 4SLE 025 070 S04	2.5	7	0.05	-	50	4	
New 4SLE 025 180 S04	2.5	7	0.05	18	60	4	
4SLE 030 080 S06	3	8	0.06	-	50	6	
4SLE 030 210 S06	3	8	0.06	21	60	6	
4SLE 040 100 S06	4	10	0.08	-	50	6	
4SLE 040 210 S06	4	10	0.08	21	60	6	
4SLE 060 150 S06	6	15	0.12	-	60	6	
4SLE 060 210 S06	6	15	0.12	21	60	6	
4SLE 080 200 S08	8	20	0.16	-	70	8	
4SLE 080 270 S08	8	20	0.16	27	70	8	
4SLE 100 250 S10	10	25	0.2	-	80	10	
4SLE 100 350 S10	10	25	0.2	35	80	10	
4SLE 120 300 S12	12	30	0.24	-	90	12	
4SLE 120 400 S12	12	30	0.24	40	90	12	
New 4SLE 140 350 S14	14	35	0.28	-	100	14	
New 4SLE 140 450 S14	14	35	0.28	45	100	14	
4SLE 160 400 S16	16	40	0.32	-	100	16	
4SLE 160 500 S16	16	40	0.32	50	100	16	
4SLE 200 450 S20	20	45	0.4	-	110	20	
4SLE 200 550 S20	20	45	0.4	55	110	20	

Order Number	날경 Diameter D	날장 Length of cut L1	면취량 Chamfer C	유효장 Effective Length L2	전장 Overall Length L	샙크 Dia d	비고

## 4날 고능률 범용 C 엔드밀

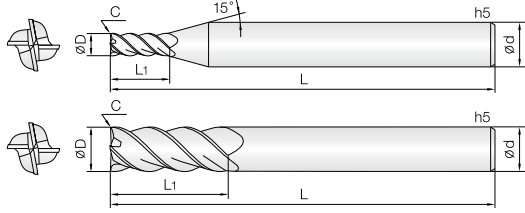

- 중저경도강(HRc 42이하), 연강, 주철, SUS계열 가공 엔드밀
- HR코팅 처리하여 다양한 피삭재 가공시 인선부에 스트레스가 적으며 내마모성 또한 향상 됩니다.
- 부등분할 방식과 가변 헬릭스 인선설계로 chatter링이 더욱 감소 하였습니다.
- 4날 적용과 깊은 포켓으로 칩배출이 원활하며, 피삭재 면조도가 우수합니다.

- Mid-low hardened steels (~HRc42), Mild steels, Cast irons, SUS
- HR coating reduces stress of flute and enhances wear resistance.
- Unequal pitch design and helix enable decrease of chattering.
- 4flutes and deep pocket enable chip evacuation and increase surface roughness.

4

WC  
미립자

HR  
Coating

38°  
Helix Angle

35°/38°  
Helix Angle

C Cutting

CUTTING  
DATA

ø1~2.5    ø3~20    C Cutting    466P

Condition	D Size	D Tolerance	Condition	D Size	D Tolerance
øD ≠ ød	ø1 ~ 6	+0 ~ -0.01mm	øD = ød	ø4 ~ 6	-0.005 ~ -0.015mm
	ø8 ~ 20	+0 ~ -0.015mm		ø8 ~ 12	-0.01 ~ -0.025mm
		ø14 ~ 20		-0.015 ~ -0.03mm	

단위 : mm

Order Number	날경 Diameter D	날장 Length of cut L1	면취량 Chamfer C	전장 Overall Length L	생크 Shank Dia d	비고	Order Number	날경 Diameter D	날장 Length of cut L1	면취량 Chamfer C	전장 Overall Length L	생크 Shank Dia d	비고
4VCC 010 020 S04	1	2	0.03	45	4								
4VCC 010 025 S06	1	2.5	0.03	50	6								
4VCC 010 035 S06	1	3.5	0.03	50	6								
4VCC 012 020 S04	1.2	2	0.04	45	4								
4VCC 012 030 S06	1.2	3	0.04	50	6								
4VCC 012 050 S06	1.2	5	0.04	50	6								
4VCC 015 030 S04	1.5	3	0.05	45	4								
4VCC 015 040 S06	1.5	4	0.05	50	6								
4VCC 015 060 S06	1.5	6	0.05	50	6								
4VCC 020 040 S04	2	4	0.075	45	4								
4VCC 020 060 S06	2	6	0.075	50	6								
4VCC 020 090 S06	2	9	0.075	50	6								
4VCC 025 050 S04	2.5	5	0.08	50	4								
4VCC 025 070 S06	2.5	7	0.08	50	6								
4VCC 025 100 S06	2.5	10	0.08	50	6								
4VCC 030 060 S04	3	6	0.1	50	4								
4VCC 030 060 S06	3	6	0.1	50	6								
4VCC 030 080 S06	3	8	0.1	50	6								
4VCC 030 120 S06	3	12	0.1	50	6								
4VCC 040 080 S04	4	8	0.15	50	4								
4VCC 040 080 S06	4	8	0.15	50	6								
4VCC 040 100 S06	4	10	0.15	50	6								
4VCC 040 150 S06	4	15	0.15	60	6								
4VCC 050 100 S06	5	10	0.15	50	6								
4VCC 050 150 S06	5	15	0.15	60	6								
4VCC 050 200 S06	5	20	0.15	70	6								
4VCC 060 120 S06	6	12	0.2	50	6								
4VCC 060 150 S06	6	15	0.2	60	6								
4VCC 060 200 S06	6	20	0.2	70	6								
4VCC 080 160 S08	8	16	0.2	60	8								
4VCC 080 200 S08	8	20	0.2	70	8								
4VCC 080 300 S08	8	30	0.2	80	8								
4VCC 100 200 S10	10	20	0.3	75	10								
4VCC 100 250 S10	10	25	0.3	75	10								
4VCC 100 350 S10	10	35	0.3	90	10								
4VCC 120 240 S12	12	24	0.35	75	12								
4VCC 120 300 S12	12	30	0.35	80	12								
4VCC 120 450 S12	12	45	0.35	100	12								
New 4VCC 140 360 S14	14	36	0.38	90	14								
New 4VCC 140 500 S14	14	50	0.38	110	14								
4VCC 160 400 S16	16	40	0.4	100	16								
4VCC 160 600 S16	16	60	0.4	120	16								
4VCC 200 450 S20	20	45	0.5	100	20								
4VCC 200 650 S20	20	65	0.5	120	20								

V series



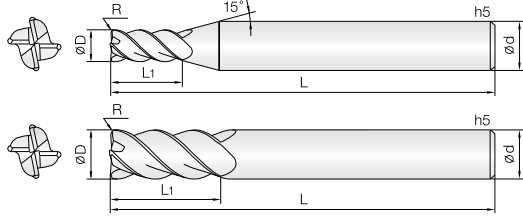

- 중저경도강(HRc 42이하), 연강, 주철, SUS계열 가공 엔드밀
- HR코팅 처리하여 다양한 피삭재 가공시 인선부에 스트레스가 적으며 내마모성 또한 향상 됩니다.
- 부등분할 방식과 가변 헬릭스 인선설계로 chatter링이 더욱 감소 하였습니다.
- 4날 적용과 깊은 포켓으로 칩배출이 원활하며, 피삭재 면조도가 우수합니다.

- Mid-low hardened steels (~HRc42), Mild steels, Cast irons, SUS
- HR coating reduces stress of flute and enhances wear resistance.
- Unequal pitch design and helix enable decrease of chattering.
- 4flutes and deep pocket enable chip evacuation and increase surface roughness.

4

WC  
미립자

HR  
Coating

R  
± 0.005

R  
± 0.01

R  
± 0.015

38°  
Helix Angle

35°/38°  
Helix Angle

CUTTING  
DATA

R0.1 ~ 0.5   R1 ~ 1.5   R2 ~ 3   Ø1~2.5   Ø3 ~ 20   466P

Condition	D Size	D Tolerance	Condition	D Size	D Tolerance
ØD ≠ ød	Ø1 ~ 20	+0 ~ -0.01mm	ØD = ød	Ø6 ~ 12	-0.005 ~ -0.015mm
				Ø14 ~ 20	-0.01 ~ -0.02mm

단위 : mm

Order Number	날경 Diameter D × R	날장 Length of cut L1	전장 Overall Length L	샙크 Dia d	비고	Order Number	날경 Diameter D × R	날장 Length of cut L1	전장 Overall Length L	샙크 Dia d	비고
4VSC 010 001 S06	1 X R0.1	2.5	50	6		New 4VSC 160 050 S16	16 X R5	40	100	16	
4VSC 010 002 S06	1 X R0.2	2.5	50	6		4VSC 200 005 S20	20 X R0.5	45	100	20	
4VSC 012 001 S06	1.2 X R0.1	3	50	6		4VSC 200 010 S20	20 X R1	45	100	20	
4VSC 012 002 S06	1.2 X R0.2	3	50	6		4VSC 200 020 S20	20 X R2	45	100	20	
4VSC 015 001 S06	1.5 X R0.1	4	50	6		4VSC 200 030 S20	20 X R3	45	100	20	
4VSC 015 002 S06	1.5 X R0.2	4	50	6		New 4VSC 200 040 S20	20 X R4	45	100	20	
4VSC 020 001 S06	2 X R0.1	6	50	6		New 4VSC 200 050 S20	20 X R5	45	100	20	
4VSC 020 002 S06	2 X R0.2	6	50	6							
4VSC 025 001 S06	2.5 X R0.1	7	50	6							
4VSC 025 002 S06	2.5 X R0.2	7	50	6							
4VSC 030 002 S06	3 X R0.2	8	50	6							
4VSC 030 003 S06	3 X R0.3	8	50	6							
4VSC 030 005 S06	3 X R0.5	8	50	6							
4VSC 040 002 S06	4 X R0.2	10	50	6							
4VSC 040 003 S06	4 X R0.3	10	50	6							
4VSC 040 005 S06	4 X R0.5	10	50	6							
New 4VSC 040 010 S06	4 X R1	10	50	6							
4VSC 050 002 S06	5 X R0.2	15	60	6							
4VSC 050 003 S06	5 X R0.3	15	60	6							
4VSC 050 005 S06	5 X R0.5	15	60	6							
New 4VSC 050 010 S06	5 X R1	15	60	6							
4VSC 060 002 S06	6 X R0.2	15	60	6							
4VSC 060 003 S06	6 X R0.3	15	60	6							
4VSC 060 005 S06	6 X R0.5	15	60	6							
4VSC 060 010 S06	6 X R1	15	60	6							
New 4VSC 060 015 S06	6 X R1.5	15	60	6							
4VSC 080 003 S08	8 X R0.3	20	70	8							
4VSC 080 005 S08	8 X R0.5	20	70	8							
4VSC 080 010 S08	8 X R1	20	70	8							
New 4VSC 080 020 S08	8 X R2	20	70	8							
4VSC 100 003 S10	10 X R0.3	25	75	10							
4VSC 100 005 S10	10 X R0.5	25	75	10							
4VSC 100 010 S10	10 X R1	25	75	10							
4VSC 100 015 S10	10 X R1.5	25	75	10							
4VSC 100 020 S10	10 X R2	25	75	10							
New 4VSC 100 030 S10	10 X R3	25	75	10							
4VSC 120 005 S12	12 X R0.5	30	80	12							
4VSC 120 010 S12	12 X R1	30	80	12							
4VSC 120 020 S12	12 X R2	30	80	12							
New 4VSC 120 030 S12	12 X R3	30	80	12							
New 4VSC 140 005 S14	14 X R0.5	36	90	14							
New 4VSC 140 010 S14	14 X R1	36	90	14							
New 4VSC 140 020 S14	14 X R2	36	90	14							
New 4VSC 140 030 S14	14 X R3	36	90	14							
New 4VSC 140 040 S14	14 X R4	36	90	14							
4VSC 160 005 S16	16 X R0.5	40	100	16							
4VSC 160 010 S16	16 X R1	40	100	16							
4VSC 160 020 S16	16 X R2	40	100	16							
4VSC 160 030 S16	16 X R3	40	100	16							
New 4VSC 160 040 S16	16 X R4	40	100	16							



6 Flutes Various Symmetry Corner R End Mills for Steel, Cast Irons & Stainless Steels

6날 고능률 범용 코너 레디우스 엔드밀

New

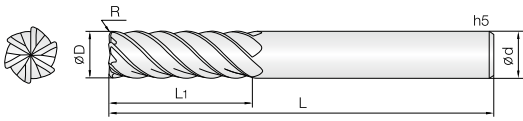

- 중저경도강(HRc 42이하), 연강, 주철, SUS계열 가공 엔드밀
- HR코팅 처리하여 다양한 피삭재 가공시 인선부에 스트레스가 적으며 내마모성 또한 향상 됩니다.
- 45° 헬릭스 형상으로 설계하여 고속, 고이송 가공에 적합 합니다.
- Mid-low hardened steels(~HRc42), Mild steels, Cast irons, SUS
- HR coating reduces stress of flute and enhances wear resistance.
- 45° helix design is suitable for high speed machining.

6 WC 미립자 HR Coating R0.5 R1~1.5 R2~3 45° Helix Angle CUTTING DATA 466P

Condition	D Size	D Tolerance	Condition	D Size	D Tolerance
$\varnothing D \neq \varnothing d$	$\varnothing 6 \sim 20$	+0 ~ -0.01mm	$\varnothing D = \varnothing d$	$\varnothing 6 \sim 12$	-0.005 ~ -0.015mm
				$\varnothing 14 \sim 20$	-0.01 ~ -0.02mm

단위 : mm

Order Number	날경 Diameter D x R	날장 Length of cut L1	전장 Overall Length L	생크 Shank Dia d	비고	Order Number	날경 Diameter D x R	날장 Length of cut L1	전장 Overall Length L	생크 Shank Dia d	비고
6VSC 060 005 S06	6 X R0.5	15	60	6							
6VSC 060 010 S06	6 X R1	15	60	6							
New 6VSC 060 015 S06	6 X R1.5	15	60	6							
6VSC 080 005 S08	8 X R0.5	20	70	8							
6VSC 080 010 S08	8 X R1	20	70	8							
New 6VSC 080 020 S08	8 X R2	20	70	8							
6VSC 100 005 S10	10 X R0.5	25	75	10							
6VSC 100 010 S10	10 X R1	25	75	10							
6VSC 100 015 S10	10 X R1.5	25	75	10							
6VSC 100 020 S10	10 X R2	25	75	10							
New 6VSC 100 030 S10	10 X R3	25	75	10							
6VSC 120 005 S12	12 X R0.5	30	80	12							
6VSC 120 010 S12	12 X R1	30	80	12							
6VSC 120 015 S12	12 X R1.5	30	80	12							
6VSC 120 020 S12	12 X R2	30	80	12							
6VSC 120 030 S12	12 X R3	30	80	12							
New 6VSC 120 040 S12	12 X R4	30	80	12							
New 6VSC 140 005 S14	14 X R0.5	36	90	14							
New 6VSC 140 010 S14	14 X R1	36	90	14							
New 6VSC 140 020 S14	14 X R2	36	90	14							
New 6VSC 140 030 S14	14 X R3	36	90	14							
New 6VSC 140 040 S14	14 X R4	36	90	14							
New 6VSC 160 005 S16	16 X R0.5	40	100	16							
6VSC 160 010 S16	16 X R1	40	100	16							
6VSC 160 015 S16	16 X R1.5	40	100	16							
6VSC 160 020 S16	16 X R2	40	100	16							
6VSC 160 030 S16	16 X R3	40	100	16							
New 6VSC 160 040 S16	16 X R4	40	100	16							
New 6VSC 160 050 S16	16 X R5	40	100	16							
New 6VSC 200 005 S20	20 X R0.5	45	100	20							
6VSC 200 010 S20	20 X R1	45	100	20							
6VSC 200 015 S20	20 X R1.5	45	100	20							
6VSC 200 020 S20	20 X R2	45	100	20							
6VSC 200 030 S20	20 X R3	45	100	20							
New 6VSC 200 040 S20	20 X R4	45	100	20							
New 6VSC 200 050 S20	20 X R5	45	100	20							







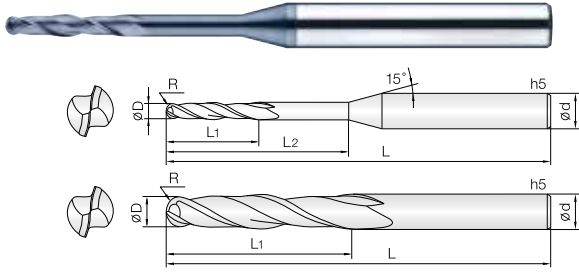

- 그래파이트(흑연), HRc48 이하의 고경도강, 프리하든강, 공구강, 주철등 다양한 피삭재 가공
- ALTIN 코팅을 적용하여 절삭저항이 적으며, 내마모성이 우수합니다.
- 긴날장으로 설계하여, 깊은 측벽가공이 많은 흑연 가공에 가장 적합합니다.
- 미립자 초경합금을 채택하여 다양한 비철합금 및 목업의 피삭재 영역에 적용이 가능합니다.

- Endmills for various work materials, graphite, hardened steels(HRc~48), pre-hardened steels, tool steels and cast irons
- Excellent performance with low cutting force by ALTIN coating.
- Long flute length optimized for deep-side wall machining of graphite.
- Applied fine WC grade optimized for various non-ferrous and non-metallic work materials.

2

WC  
미립자

ALTIN  
Coating

R  
±0.005

R  
±0.01

R  
±0.015

30°  
Helix Angle

CUTTING  
DATA

0.25 ~ 2.5R    3 ~ 6R    8 ~ 12.5R    469P

Condition	D Size	D Tolerance	Condition	D Size	D Tolerance
øD ≠ ød	ø0.5 ~ 25	+0 ~ -0.01mm	øD = ød	ø3 ~ 12	-0.005 ~ -0.015mm
				ø16 ~ 25	-0.01 ~ -0.02mm

단위 : mm

Order Number	날경 Diameter R × D	날장 Length of cut L1	유효장 Effective Length L2	전장 Overall Length L	생크 Shank Dia d	비고	Order Number	날경 Diameter R × D	날장 Length of cut L1	유효장 Effective Length L2	전장 Overall Length L	생크 Shank Dia d	비고
2GBE 005 020 S04	0.25R X 0.5	2	-	50	4		2GBE 050 250 S06	2.5R X 5	25	-	90	6	
2GBE 005 050 S04	0.25R X 0.5	2	5	50	4		2GBE 050 500 S06	2.5R X 5	25	50	110	6	
2GBE 010 050 S04	0.5R X 1	5	-	60	4		2GBE 060 250 110	3R X 6	25	-	110	6	
2GBE 010 050 S06	0.5R X 1	5	-	60	6		2GBE 060 300 150	3R X 6	30	-	150	6	
2GBE 010 100 S04	0.5R X 1	5	10	60	4		2GBE 060 300 200	3R X 6	30	-	200	6	
2GBE 010 100 S06	0.5R X 1	5	10	60	6		2GBE 060 300 220	3R X 6	30	-	220	6	
2GBE 010 150 S04	0.5R X 1	5	15	60	4		2GBE 080 350 110	4R X 8	35	-	110	8	
2GBE 010 200 S04	0.5R X 1	5	20	60	4		2GBE 080 400 150	4R X 8	40	-	150	8	
2GBE 010 250 S04	0.5R X 1	5	25	70	4		2GBE 080 400 200	4R X 8	40	-	200	8	
2GBE 010 300 S04	0.5R X 1	5	30	80	4		2GBE 080 400 220	4R X 8	40	-	220	8	
2GBE 010 350 S04	0.5R X 1	5	35	80	4		2GBE 100 400 120	5R X 10	40	-	120	10	
2GBE 010 400 S04	0.5R X 1	5	40	90	4		2GBE 100 450 150	5R X 10	45	-	150	10	
2GBE 015 080 S06	0.75R X 1.5	8	-	60	6		2GBE 100 450 200	5R X 10	45	-	200	10	
2GBE 015 100 S04	0.75R X 1.5	8	10	60	4		2GBE 100 450 230	5R X 10	45	-	230	10	
2GBE 015 150 S04	0.75R X 1.5	8	15	60	4		2GBE 120 500 130	6R X 12	50	-	130	12	
2GBE 015 150 S06	0.75R X 1.5	8	15	60	6		2GBE 120 500 150	6R X 12	50	-	150	12	
2GBE 015 200 S04	0.75R X 1.5	8	20	60	4		2GBE 120 550 200	6R X 12	55	-	200	12	
2GBE 015 250 S04	0.75R X 1.5	8	25	70	4		2GBE 120 550 250	6R X 12	55	-	250	12	
2GBE 015 300 S04	0.75R X 1.5	8	30	80	4		2GBE 160 600 160	8R X 16	60	-	160	16	
2GBE 015 350 S04	0.75R X 1.5	8	35	80	4		2GBE 160 650 200	8R X 16	65	-	200	16	
2GBE 015 400 S04	0.75R X 1.5	8	40	90	4		2GBE 160 650 250	8R X 16	65	-	250	16	
2GBE 020 100 S04	1R X 2	10	-	60	4		2GBE 160 700 320	8R X 16	70	-	320	16	
2GBE 020 100 S06	1R X 2	10	-	70	6		2GBE 200 700 160	10R X 20	70	-	160	20	
2GBE 020 150 S04	1R X 2	10	15	60	4		2GBE 200 750 200	10R X 20	75	-	200	20	
2GBE 020 200 S04	1R X 2	10	20	60	4		2GBE 200 750 250	10R X 20	75	-	250	20	
2GBE 020 200 S06	1R X 2	10	20	70	6		2GBE 200 900 320	10R X 20	90	-	320	20	
2GBE 020 250 S04	1R X 2	10	25	70	4		2GBE 250 1000 250	12.5R X 25	100	-	250	25	
2GBE 020 300 S04	1R X 2	10	30	80	4								
2GBE 020 350 S04	1R X 2	10	35	80	4								
2GBE 020 400 S04	1R X 2	10	40	90	4								
2GBE 020 500 S04	1R X 2	10	50	100	4								
2GBE 020 600 S04	1R X 2	10	60	100	4								
2GBE 025 200 S04	1.25R X 2.5	10	20	70	4								
2GBE 030 150 100	1.5R X 3	15	-	100	3								
2GBE 030 150 S06	1.5R X 3	15	-	70	6								
2GBE 030 200 S04	1.5R X 3	15	20	70	4								
2GBE 030 300 S04	1.5R X 3	15	30	80	4								
2GBE 030 300 S06	1.5R X 3	15	30	75	6								
2GBE 030 400 S04	1.5R X 3	15	40	90	4								
2GBE 030 400 S06	1.5R X 3	15	40	90	6								
2GBE 030 500 S04	1.5R X 3	15	50	100	4								
2GBE 030 600 S04	1.5R X 3	15	60	100	4								
2GBE 040 200 080	2R X 4	20	-	80	4								
2GBE 040 200 100	2R X 4	20	-	100	4								
2GBE 040 200 130	2R X 4	20	-	130	4								
2GBE 040 200 S06	2R X 4	20	-	75	6								
2GBE 040 350 S06	2R X 4	20	35	90	6								
2GBE 040 450 S06	2R X 4	20	45	100	6								
2GBE 050 250 100	2.5R X 5	25	-	100	5								
2GBE 050 250 130	2.5R X 5	25	-	130	5								

FOR GRAPHITE



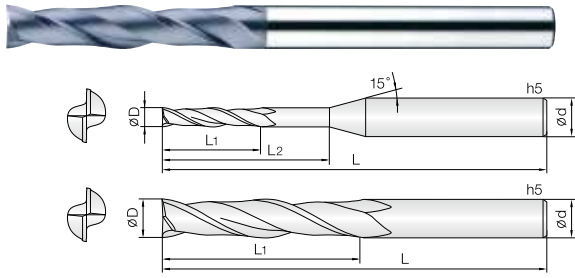

- 그래파이트(흑연), HRC48 이하의 고경도강, 프리하든강, 공구강, 주철등 다양한 피삭재 가공
- ALTIN 코팅을 적용하여 절삭저항이 적으며, 내마모성이 우수합니다.
- 긴날장으로 설계하여, 깊은 측벽가공이 많은 흑연 가공에 가장 적합합니다.
- 미립자 초경합금을 채택하여 HRC48 이하의 다양한 합금강의 피삭재 영역에 적용이 가능합니다.

- Endmills for various work materials, graphite, hardened steels(HRC~48), pre-hardened steels, tool steels and cast irons
- Excellent performance with low cutting force by ALTIN coating.
- Long flute length optimized for deep-side wall machining of graphite.
- Applied fine WC grade optimized for various alloy steels applications, below HRC48.



Shield Edge 471P

Condition	D Size	D Tolerance	Condition	D Size	D Tolerance
øD ≠ ød	ø0.5 ~ 6	+0 ~ -0.01mm	øD = ød	ø4 ~ 6	-0.005 ~ -0.015mm
	ø8 ~ 20	+0 ~ -0.015mm		ø8 ~ 12	-0.01 ~ -0.025mm
		ø16 ~ 20		-0.015 ~ -0.03mm	

단위 : mm

Order Number	날경 Diameter D	날장 Length of cut L1	유효장 Effective Length L2	전장 Overall Length L	샹크 Shank Dia d	비고	Order Number	날경 Diameter D	날장 Length of cut L1	유효장 Effective Length L2	전장 Overall Length L	샹크 Shank Dia d	비고
2GEM 005 020 S04	0.5	2	-	50	4								
2GEM 010 050 S04	1	5	-	60	4								
2GEM 010 100 S04	1	5	10	60	4								
2GEM 010 100 S06	1	5	10	60	6								
2GEM 010 150 S04	1	5	15	60	4								
2GEM 010 200 S04	1	5	20	60	4								
2GEM 010 250 S04	1	5	25	70	4								
2GEM 015 100 S04	1.5	10	-	60	4								
2GEM 015 150 S04	1.5	8	15	60	4								
2GEM 015 200 S04	1.5	8	20	60	4								
2GEM 015 200 S06	1.5	8	20	60	6								
2GEM 015 250 S04	1.5	8	25	70	4								
2GEM 020 100 S04	2	10	-	60	4								
2GEM 020 150 S04	2	10	15	60	4								
2GEM 020 200 S04	2	10	20	60	4								
2GEM 020 200 S06	2	10	20	60	6								
2GEM 020 250 S04	2	10	25	70	4								
2GEM 020 300 S04	2	10	30	80	4								
2GEM 030 150 S04	3	15	-	70	4								
2GEM 030 250 S04	3	15	25	75	4								
2GEM 030 300 S06	3	15	30	75	6								
2GEM 040 200 100	4	20	-	100	4								
2GEM 040 400 S06	4	20	40	100	6								
2GEM 050 250 100	5	25	-	100	5								
2GEM 060 300 110	6	30	-	110	6								
2GEM 060 300 150	6	30	-	150	6								
2GEM 080 400 150	8	40	-	150	8								
2GEM 100 450 150	10	45	-	150	10								
2GEM 100 500 200	10	50	-	200	10								
2GEM 120 600 150	12	60	-	150	12								
2GEM 120 600 200	12	60	-	200	12								
2GEM 160 600 130	16	60	-	130	16								
2GEM 160 700 160	16	70	-	160	16								
2GEM 160 700 200	16	70	-	200	16								
2GEM 200 800 160	20	80	-	160	20								
2GEM 200 900 200	20	90	-	200	20								
2GEM 200 1200 320	20	120	-	320	20								





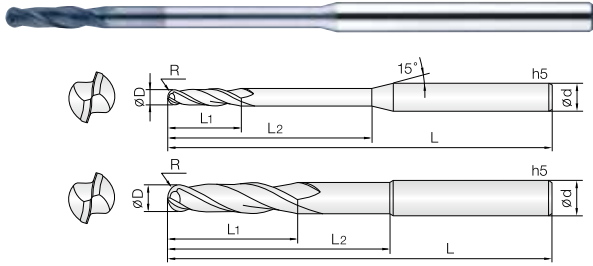

- 그래파이트(흑연), 강화플라스틱, 탄소섬유 등 비철, 비금속 계열의 다양한 피삭재 전용 엔드밀
- CVD 순수 다이아몬드 코팅을 적용하여 내마모성이 우수합니다.
- 다양한 피삭재의 형상에 적용하도록 규격을 다양화하여, 넓은 가공 영역에 뛰어난 수명과 성능을 발휘합니다.

- Endmills for Graphite, reinforced plastic, carbon fiber, Non-ferrous and non-metallic materials.
- Excellent wear resistance by applying qualified CVD diamond coating.
- Wide range products prepared for various work shape and excellent performance.



0.1 ~ 6R

472P

D Size	D Tolerance
Ø 0.2 ~ 12	+0 ~ -0.02mm

단위 : mm

Order Number	날경 Diameter R × D	날장 Length of cut L1	유효장 Effective Length L2	전장 Overall Length L	샙크 Shank Dia d	비고	Order Number	날경 Diameter R × D	날장 Length of cut L1	유효장 Effective Length L2	전장 Overall Length L	샙크 Shank Dia d	비고
2DBE 002 010 S04	0.1R X 0.2	1	-	45	4		2DBE 010 500 S04	0.5R X 1	3	50	80	4	
2DBE 003 012 S04	0.15R X 0.3	1.2	-	45	4		2DBE 015 045 S04	0.75R X 1.5	4.5	-	60	4	
2DBE 003 020 S04	0.15R X 0.3	1.2	2	45	4		2DBE 015 080 S04	0.75R X 1.5	4.5	8	80	4	
2DBE 004 015 S04	0.2R X 0.4	1.5	-	45	4		2DBE 015 100 S04	0.75R X 1.5	4.5	10	80	4	
2DBE 004 020 S04	0.2R X 0.4	1.5	2	45	4		2DBE 015 120 S04	0.75R X 1.5	4.5	12	80	4	
2DBE 004 030 S04	0.2R X 0.4	1.5	3	45	4		2DBE 015 150 S04	0.75R X 1.5	4.5	15	80	4	
2DBE 004 040 S04	0.2R X 0.4	1.5	4	45	4		2DBE 015 180 S04	0.75R X 1.5	4.5	18	80	4	
2DBE 004 050 S04	0.2R X 0.4	1.5	5	45	4		2DBE 015 200 S04	0.75R X 1.5	4.5	20	80	4	
2DBE 004 080 S04	0.2R X 0.4	1.5	8	45	4		2DBE 015 250 S04	0.75R X 1.5	4.5	25	80	4	
2DBE 004 100 S04	0.2R X 0.4	1.5	10	45	4		2DBE 015 300 S04	0.75R X 1.5	4.5	30	80	4	
2DBE 005 020 S04	0.25R X 0.5	2	-	45	4		2DBE 015 350 S04	0.75R X 1.5	4.5	35	80	4	
2DBE 005 030 S04	0.25R X 0.5	2	3	45	4		2DBE 015 400 S04	0.75R X 1.5	4.5	40	80	4	
2DBE 005 040 S04	0.25R X 0.5	2	4	45	4		2DBE 020 060 S04	1R X 2	6	-	60	4	
2DBE 005 050 S04	0.25R X 0.5	2	5	45	4		2DBE 020 100 S04	1R X 2	6	10	80	4	
2DBE 005 060 S04	0.25R X 0.5	2	6	45	4		2DBE 020 150 S04	1R X 2	6	15	80	4	
2DBE 005 080 S04	0.25R X 0.5	2	8	45	4		2DBE 020 200 S04	1R X 2	6	20	80	4	
2DBE 005 100 S04	0.25R X 0.5	2	10	45	4		2DBE 020 250 S04	1R X 2	6	25	80	4	
2DBE 005 120 S04	0.25R X 0.5	2	12	45	4		2DBE 020 300 S04	1R X 2	6	30	80	4	
2DBE 006 020 S04	0.3R X 0.6	2	-	45	4		2DBE 020 350 S04	1R X 2	6	35	80	4	
2DBE 006 030 S04	0.3R X 0.6	2	3	45	4		2DBE 020 400 S04	1R X 2	6	40	100	4	
2DBE 006 040 S04	0.3R X 0.6	2	4	45	4		2DBE 020 450 S04	1R X 2	6	45	100	4	
2DBE 006 050 S04	0.3R X 0.6	2	5	45	4		2DBE 020 500 S04	1R X 2	6	50	100	4	
2DBE 006 060 S04	0.3R X 0.6	2	6	45	4		2DBE 020 600 S04	1R X 2	6	60	100	4	
2DBE 006 080 S04	0.3R X 0.6	2	8	45	4		2DBE 020 700 S04	1R X 2	6	70	100	4	
2DBE 006 100 S04	0.3R X 0.6	2	10	45	4		2DBE 030 150 100	1.5R X 3	8	15	100	3	
2DBE 006 120 S04	0.3R X 0.6	2	12	45	4		2DBE 030 080 S04	1.5R X 3	8	-	60	4	
2DBE 006 150 S04	0.3R X 0.6	2	15	45	4		2DBE 030 080 S06	1.5R X 3	3	8	60	6	
2DBE 006 200 S04	0.3R X 0.6	2	20	45	4		2DBE 030 150 S04	1.5R X 3	8	15	100	4	
2DBE 008 030 S04	0.4R X 0.8	3	-	45	4		2DBE 030 200 S04	1.5R X 3	8	20	100	4	
2DBE 008 040 S04	0.4R X 0.8	3	4	45	4		2DBE 030 250 S04	1.5R X 3	8	25	100	4	
2DBE 008 050 S04	0.4R X 0.8	3	5	45	4		2DBE 030 300 S04	1.5R X 3	8	30	100	4	
2DBE 008 060 S04	0.4R X 0.8	3	6	45	4		2DBE 030 350 S04	1.5R X 3	8	35	100	4	
2DBE 008 080 S04	0.4R X 0.8	3	8	45	4		2DBE 030 400 S04	1.5R X 3	8	40	100	4	
2DBE 008 100 S04	0.4R X 0.8	3	10	45	4		2DBE 030 500 S04	1.5R X 3	8	50	100	4	
2DBE 008 150 S04	0.4R X 0.8	3	15	45	4		2DBE 030 600 S04	1.5R X 3	8	60	100	4	
2DBE 008 200 S04	0.4R X 0.8	3	20	45	4		2DBE 030 700 S04	1.5R X 3	8	70	100	4	
2DBE 010 030 S04	0.5R X 1	3	-	60	4		2DBE 040 040 060	2R X 4	4	-	60	4	
2DBE 010 040 S04	0.5R X 1	3	4	60	4		2DBE 040 160 060	2R X 4	16	-	60	4	
2DBE 010 050 S04	0.5R X 1	3	5	60	4		2DBE 040 160 080	2R X 4	16	-	80	4	
2DBE 010 060 S04	0.5R X 1	3	6	60	4		2DBE 040 300 080	2R X 4	16	30	80	4	
2DBE 010 080 S04	0.5R X 1	3	8	60	4		2DBE 040 160 100	2R X 4	16	-	100	4	
2DBE 010 100 S04	0.5R X 1	3	10	60	4		2DBE 040 400 100	2R X 4	16	40	100	4	
2DBE 010 120 S04	0.5R X 1	3	12	60	4		2DBE 040 160 130	2R X 4	16	-	130	4	
2DBE 010 150 S04	0.5R X 1	3	15	60	4		2DBE 040 400 130	2R X 4	16	40	130	4	
2DBE 010 200 S04	0.5R X 1	3	20	60	4		2DBE 040 160 150	2R X 4	16	-	150	4	
2DBE 010 250 S04	0.5R X 1	3	25	80	4		2DBE 040 500 150	2R X 4	16	50	150	4	
2DBE 010 300 S04	0.5R X 1	3	30	80	4		2DBE 050 160 110	2.5R X 5	16	-	110	5	
2DBE 010 350 S04	0.5R X 1	3	35	80	4		2DBE 050 400 110	2.5R X 5	16	40	110	5	
2DBE 010 400 S04	0.5R X 1	3	40	80	4		2DBE 050 200 S06	2.5R X 5	16	20	110	6	
2DBE 010 450 S04	0.5R X 1	3	45	80	4		2DBE 050 400 S06	2.5R X 5	16	40	110	6	





2 Flutes Diamond Coated Ball End Mills for Graphite

## 2날 흑연가공용 다이아몬드 코팅 볼 엔드밀

단위 : mm

Order Number	날경 Diameter R × D	날장 Length of cut L1	유효장 Effective Length L2	전장 Overall Length L	생크 Shank Dia d	비고	Order Number	날경 Diameter R × D	날장 Length of cut L1	유효장 Effective Length L2	전장 Overall Length L	생크 Shank Dia d	비고
2DBE 050 600 S06	2.5R X 5	16	60	110	6								
New 2DBE 060 100 060	3R X 6	10	-	60	6								
2DBE 060 250 080	3R X 6	16	25	80	6								
2DBE 060 250 110	3R X 6	16	25	110	6								
2DBE 060 400 110	3R X 6	16	40	110	6								
2DBE 060 300 150	3R X 6	16	30	150	6								
2DBE 060 500 150	3R X 6	16	50	150	6								
2DBE 080 300 080	4R X 8	20	30	80	8								
2DBE 080 300 110	4R X 8	20	30	110	8								
2DBE 080 400 110	4R X 8	20	40	110	8								
2DBE 080 500 150	4R X 8	20	50	150	8								
2DBE 080 400 200	4R X 8	20	40	200	8								
2DBE 100 400 080	5R X 10	22	40	80	10								
2DBE 100 400 110	5R X 10	22	40	110	10								
2DBE 100 500 110	5R X 10	22	50	110	10								
2DBE 100 600 160	5R X 10	22	60	160	10								
2DBE 100 500 200	5R X 10	22	50	200	10								
2DBE 120 500 110	6R X 12	25	50	110	12								
2DBE 120 500 160	6R X 12	25	50	160	12								
2DBE 120 600 200	6R X 12	25	60	200	12								

FOR GRAPHITE

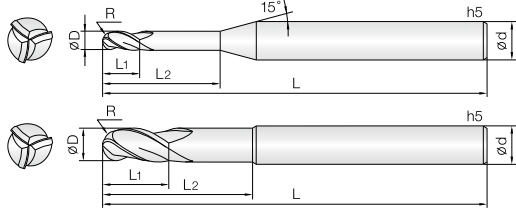

- 그래파이트(흑연), 강화플라스틱, 탄소섬유 등 비철, 비금속 계열의 다양한 피삭재 전용 엔드밀
- CVD 순수 다이아몬드 코팅을 적용하여 내마모성이 우수합니다.
- 다양한 피삭재의 형상에 적용하도록 규격을 다양화하여, 넓은 가공 영역에 뛰어난 수명과 성능을 발휘합니다.
- Endmills for Graphite, reinforced plastics, carbon fiber, Non-ferrous and non-metallic materials.
- Excellent wear resistance by applying qualified CVD diamond coating.
- Wide range products prepared for various work shape and excellent performance.



0.5 ~ 6R

472P

D Size	D Tolerance
Ø 1 ~ 12	+0 ~ -0.02mm

단위 : mm

Order Number	날경 Diameter R × D	날장 Length of cut L1	유효장 Effective Length L2	전장 Overall Length L	샤프크 Shank Dia d	비고	Order Number	날경 Diameter R × D	날장 Length of cut L1	유효장 Effective Length L2	전장 Overall Length L	샤프크 Shank Dia d	비고
3DBE 010 030 S04	0.5R X 1	3	-	60	4		3DBE 060 500 150	3R X 6	16	50	150	6	
3DBE 010 050 S04	0.5R X 1	3	5	60	4		3DBE 060 500 180	3R X 6	16	50	180	6	
3DBE 010 100 S04	0.5R X 1	3	10	60	4		3DBE 080 400 110	4R X 8	20	40	110	8	
3DBE 010 150 S04	0.5R X 1	3	15	60	4		3DBE 080 500 150	4R X 8	20	50	150	8	
3DBE 010 200 S04	0.5R X 1	3	20	60	4		3DBE 100 400 110	5R X 10	22	40	110	10	
3DBE 010 250 S04	0.5R X 1	3	25	80	4		3DBE 100 600 160	5R X 10	22	60	160	10	
3DBE 010 300 S04	0.5R X 1	3	30	80	4		3DBE 120 500 110	6R X 12	25	50	110	12	
3DBE 010 350 S04	0.5R X 1	3	35	80	4		3DBE 120 500 160	6R X 12	25	50	160	12	
3DBE 010 400 S04	0.5R X 1	3	40	80	4		3DBE 120 600 200	6R X 12	25	60	200	12	
3DBE 010 450 S04	0.5R X 1	3	45	80	4								
3DBE 010 500 S04	0.5R X 1	3	50	80	4								
3DBE 015 045 S04	0.75R X 1.5	4.5	-	60	4								
3DBE 015 100 S04	0.75R X 1.5	4.5	10	80	4								
3DBE 015 150 S04	0.75R X 1.5	4.5	15	80	4								
3DBE 015 200 S04	0.75R X 1.5	4.5	20	80	4								
3DBE 015 250 S04	0.75R X 1.5	4.5	25	80	4								
3DBE 015 300 S04	0.75R X 1.5	4.5	30	80	4								
3DBE 015 350 S04	0.75R X 1.5	4.5	35	80	4								
3DBE 015 400 S04	0.75R X 1.5	4.5	40	80	4								
3DBE 015 450 S04	0.75R X 1.5	4.5	45	80	4								
3DBE 015 500 S04	0.75R X 1.5	4.5	50	80	4								
3DBE 020 060 S04	1R X 2	6	-	60	4								
3DBE 020 100 S04	1R X 2	6	10	80	4								
3DBE 020 150 S04	1R X 2	6	15	80	4								
3DBE 020 200 S04	1R X 2	6	20	80	4								
3DBE 020 250 S04	1R X 2	6	25	80	4								
3DBE 020 300 S04	1R X 2	6	30	80	4								
3DBE 020 350 S04	1R X 2	6	35	80	4								
3DBE 020 400 S04	1R X 2	6	40	100	4								
3DBE 020 500 S04	1R X 2	6	50	100	4								
3DBE 020 600 S04	1R X 2	6	60	100	4								
3DBE 020 700 S04	1R X 2	6	70	100	4								
3DBE 030 150 100	1.5R X 3	8	15	100	3								
3DBE 030 080 S04	1.5R X 3	8	-	60	4								
3DBE 030 150 S04	1.5R X 3	8	15	100	4								
3DBE 030 200 S04	1.5R X 3	8	20	100	4								
3DBE 030 300 S04	1.5R X 3	8	30	100	4								
3DBE 030 400 S04	1.5R X 3	8	40	100	4								
3DBE 030 500 S04	1.5R X 3	8	50	100	4								
3DBE 040 160 080	2R X 4	16	-	80	4								
3DBE 040 300 080	2R X 4	16	30	80	4								
3DBE 040 160 100	2R X 4	16	-	100	4								
3DBE 040 400 100	2R X 4	16	40	100	4								
3DBE 040 160 130	2R X 4	16	-	130	4								
3DBE 040 400 130	2R X 4	16	40	130	4								
3DBE 050 160 110	2.5R X 5	16	-	110	5								
3DBE 050 400 110	2.5R X 5	16	40	110	5								
3DBE 060 250 110	3R X 6	16	25	110	6								
3DBE 060 400 110	3R X 6	16	40	110	6								
3DBE 060 300 150	3R X 6	16	30	150	6								

## 3날 흑연가공용 다이아몬드 테이퍼 넥 볼 엔드밀

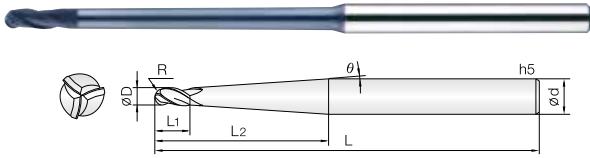

- 그래파이트 (흑연), 강화플라스틱, 탄소섬유 등 비철, 비금속 계열의 다양한 피삭재 전용 엔드밀
- CVD 순수 다이아몬드 코팅을 적용하여 내마모성이 우수합니다.
- 다양한 피삭재의 형상에 적용하도록 규격을 다양화하여, 넓은 가공 영역에 뛰어난 수명과 성능을 발휘합니다.

- Endmills for Graphite, reinforced plastics, carbon fiber, Non-ferrous and non-metallic materials.
- Excellent wear resistance by applying qualified CVD diamond coating.
- Wide range products prepared for various work shape and excellent performance.

3 미립자
WC Coating
DIA. Coating
R ± 0.01
30° Helix Angle
CUTTING DATA

0.5 ~ 2R      470P

D Size	D Tolerance
φ 1 ~ 4	+0 ~ -0.04mm

단위 : mm

Order Number	날경 Diameter R x D	각도 Angle θ	날장 Length of cut L1	유효장 Effective Length L2	전장 Overall Length L	셱크 Shank Dia d	비고	Order Number	날경 Diameter R x D	각도 Angle θ	날장 Length of cut L1	유효장 Effective Length L2	전장 Overall Length L	셱크 Shank Dia d	비고
3TBD 010 003 300	0.5R X 1	0°30'	3	30	100	4									
3TBD 010 003 400	0.5R X 1	0°30'	3	40	100	4									
3TBD 010 003 500	0.5R X 1	0°30'	3	50	100	4									
3TBD 010 010 300	0.5R X 1	1°	3	30	100	4									
3TBD 010 010 400	0.5R X 1	1°	3	40	100	4									
3TBD 010 010 500	0.5R X 1	1°	3	50	100	4									
3TBD 010 010 600	0.5R X 1	1°	3	60	100	4									
3TBD 015 003 300	0.75R X 1.5	0°30'	4	30	100	4									
3TBD 015 003 400	0.75R X 1.5	0°30'	4	40	100	4									
3TBD 015 003 500	0.75R X 1.5	0°30'	4	50	100	4									
3TBD 015 010 400	0.75R X 1.5	1°	4	40	100	4									
3TBD 015 010 500	0.75R X 1.5	1°	4	50	100	4									
3TBD 015 010 600	0.75R X 1.5	1°	4	60	100	4									
3TBD 020 003 400	1R X 2	0°30'	5	40	130	4									
3TBD 020 003 500	1R X 2	0°30'	5	50	130	4									
3TBD 020 003 600	1R X 2	0°30'	5	60	130	4									
3TBD 020 010 500	1R X 2	1°	5	50	130	4									
3TBD 020 010 600	1R X 2	1°	5	60	130	4									
3TBD 020 010 700	1R X 2	1°	5	70	130	4									
3TBD 030 003 600	1.5R X 3	0°30'	6	60	150	6									
3TBD 030 003 800	1.5R X 3	0°30'	6	80	150	6									
3TBD 030 010 700	1.5R X 3	1°	6	70	150	6									
3TBD 030 010 900	1.5R X 3	1°	6	90	150	6									
3TBD 040 003 800	2R X 4	0°30'	8	80	150	6									
3TBD 040 003 1000	2R X 4	0°30'	8	100	150	6									
3TBD 040 010 650	2R X 4	1°	8	65	150	6									

FOR GRAPHITE

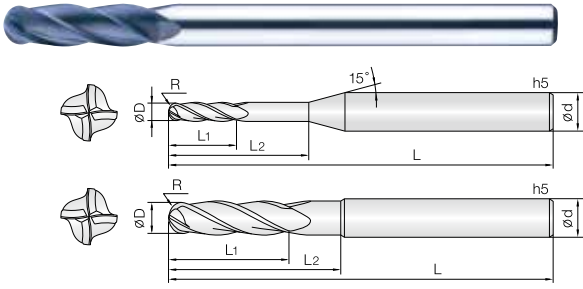

- 그래파이트(흑연), 강화플라스틱, 탄소섬유 등 비철, 비금속 계열의 다양한 피삭재 전용 엔드밀
- CVD 순수 다이아몬드 코팅을 적용하여 내마모성이 우수합니다.
- 다양한 피삭재의 형상에 적용하도록 규격을 다양화하여, 넓은 가공 영역에 뛰어난 수명과 성능을 발휘합니다.

#### Endmills for Graphite, reinforced plastics, carbon fiber, Non-ferrous and non-metallic materials.

- Excellent wear resistance by applying qualified CVD diamond coating.
- Wide range products prepared for various work shape and excellent performance.



D Size	D Tolerance
Ø 1 ~ 12	+0 ~ -0.02mm

단위 : mm

Order Number	날경 Diameter R × D	날장 Length of cut L1	유효장 Effective Length L2	전장 Overall Length L	샙크 Shank Dia d	비고	Order Number	날경 Diameter R × D	날장 Length of cut L1	유효장 Effective Length L2	전장 Overall Length L	샙크 Shank Dia d	비고
4DBE 010 030 S04	0.5R X 1	3	-	60	4		4DBE 100 400 160	5R X 10	22	40	160	10	
4DBE 010 050 S04	0.5R X 1	3	5	60	4		4DBE 100 500 200	5R X 10	22	50	200	10	
4DBE 010 100 S04	0.5R X 1	3	10	60	4		4DBE 120 500 110	6R X 12	25	50	110	12	
4DBE 010 150 S04	0.5R X 1	3	15	60	4		4DBE 120 500 160	6R X 12	25	50	160	12	
4DBE 010 200 S04	0.5R X 1	3	20	60	4		4DBE 120 600 200	6R X 12	25	60	200	12	
4DBE 010 250 S04	0.5R X 1	3	25	60	4								
4DBE 010 300 S04	0.5R X 1	3	30	80	4								
4DBE 010 350 S04	0.5R X 1	3	35	80	4								
4DBE 010 400 S04	0.5R X 1	3	40	80	4								
4DBE 010 450 S04	0.5R X 1	3	45	80	4								
4DBE 010 500 S04	0.5R X 1	3	50	80	4								
4DBE 015 045 S04	0.75R X 1.5	4.5	-	60	4								
4DBE 015 100 S04	0.75R X 1.5	4.5	10	60	4								
4DBE 015 150 S04	0.75R X 1.5	4.5	15	60	4								
4DBE 015 200 S04	0.75R X 1.5	4.5	20	60	4								
4DBE 015 250 S04	0.75R X 1.5	4.5	25	60	4								
4DBE 015 300 S04	0.75R X 1.5	4.5	30	80	4								
4DBE 015 350 S04	0.75R X 1.5	4.5	35	80	4								
4DBE 015 400 S04	0.75R X 1.5	4.5	40	80	4								
4DBE 015 450 S04	0.75R X 1.5	4.5	45	80	4								
4DBE 015 500 S04	0.75R X 1.5	4.5	50	80	4								
4DBE 020 060 S04	1R X 2	6	-	60	4								
4DBE 020 100 S04	1R X 2	6	10	80	4								
4DBE 020 200 S04	1R X 2	6	20	80	4								
4DBE 020 300 S04	1R X 2	6	30	80	4								
4DBE 020 400 S04	1R X 2	6	40	80	4								
4DBE 020 500 S04	1R X 2	6	50	100	4								
4DBE 020 600 S04	1R X 2	6	60	100	4								
4DBE 020 700 S04	1R X 2	6	70	100	4								
4DBE 030 080 S04	1.5R X 3	8	-	60	4								
4DBE 030 150 S04	1.5R X 3	8	15	100	4								
4DBE 030 200 S04	1.5R X 3	8	20	100	4								
4DBE 030 300 S04	1.5R X 3	8	30	100	4								
4DBE 030 400 S04	1.5R X 3	8	40	100	4								
4DBE 030 500 S04	1.5R X 3	8	50	100	4								
4DBE 030 600 S04	1.5R X 3	8	60	100	4								
4DBE 030 700 S04	1.5R X 3	8	70	100	4								
4DBE 040 160 060	2R X 4	16	-	60	4								
4DBE 040 160 080	2R X 4	16	-	80	4								
4DBE 040 160 100	2R X 4	16	-	100	4								
4DBE 040 160 130	2R X 4	16	-	130	4								
4DBE 060 250 080	3R X 6	16	25	80	6								
4DBE 060 250 110	3R X 6	16	25	110	6								
4DBE 060 300 150	3R X 6	16	30	150	6								
4DBE 080 300 080	4R X 8	20	30	80	8								
4DBE 080 300 110	4R X 8	20	30	110	8								
4DBE 080 350 150	4R X 8	20	35	150	8								
4DBE 080 400 200	4R X 8	20	40	200	8								
4DBE 100 350 080	5R X 10	22	35	80	10								
4DBE 100 350 110	5R X 10	22	35	110	10								

FOR GRAPHITE

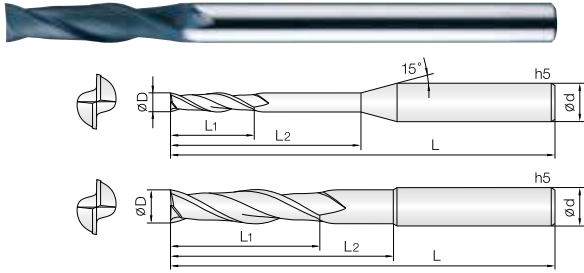

- 그래파이트(흑연), 강화플라스틱, 탄소섬유 등 비철, 비금속 계열의 다양한 피삭재 전용 엔드밀
- CVD 순수다이아몬드 코팅을 적용하여 내마모성이 우수합니다.
- 다양한 피삭재의 형상에 적용하도록 규격을 다양화하여, 넓은 가공 영역에 뛰어난 수명과 성능을 발휘합니다.
- Endmills for Graphite, reinforced plastics, carbon fiber, Non-ferrous and non-metallic materials.
- Excellent wear resistance by applying qualified CVD diamond coating.
- Wide range products prepared for various work shape and excellent performance.



D Size	D Tolerance
∅0.2 ~ 12	+0 ~ -0.02mm

단위 : mm

Order Number	날경 Diameter D	날장 Length of cut L1	유효장 Effective Length L2	전장 Overall Length L	생크 Shank Dia d	비고	Order Number	날경 Diameter D	날장 Length of cut L1	유효장 Effective Length L2	전장 Overall Length L	생크 Shank Dia d	비고
2DEM 002 004 S04	0.2	0.4	-	45	4		2DEM 040 120 S06	4	12	-	50	6	
2DEM 003 006 S04	0.3	0.6	-	45	4		2DEM 040 160 080	4	16	-	80	4	
2DEM 003 020 S04	0.3	0.6	2	45	4		2DEM 050 150 S06	5	15	-	60	6	
2DEM 003 040 S04	0.3	0.6	4	45	4		2DEM 050 200 S06	5	20	-	110	6	
2DEM 004 008 S04	0.4	0.8	-	45	4		2DEM 060 180 S06	6	18	-	60	6	
2DEM 004 020 S04	0.4	0.8	2	45	4		2DEM 060 250 110	6	25	-	110	6	
2DEM 004 040 S04	0.4	0.8	4	45	4		2DEM 060 250 150	6	25	-	150	6	
2DEM 005 010 S04	0.5	1	-	45	4		2DEM 080 240 S08	8	24	-	70	8	
2DEM 005 030 S04	0.5	1	3	45	4		2DEM 080 400 150	8	25	40	150	8	
2DEM 005 050 S04	0.5	1	5	45	4		2DEM 100 250 S10	10	25	-	80	10	
2DEM 006 012 S04	0.6	1.2	-	45	4		2DEM 100 500 160	10	25	50	160	10	
2DEM 006 030 S04	0.6	1.2	3	45	4		2DEM 120 250 S12	12	25	-	80	12	
2DEM 006 050 S04	0.6	1.2	5	45	4		2DEM 120 600 160	12	25	60	160	12	
2DEM 007 015 S04	0.7	1.5	-	45	4								
2DEM 007 040 S04	0.7	1.5	4	45	4								
2DEM 007 060 S04	0.7	1.5	6	45	4								
2DEM 007 080 S04	0.7	1.5	8	45	4								
2DEM 008 020 S04	0.8	2	-	45	4								
2DEM 009 025 S04	0.9	2.5	-	45	4								
2DEM 010 030 S04	1	3	-	60	4								
2DEM 010 030 045	1	3	-	45	4								
2DEM 010 050 S04	1	3	5	60	4								
2DEM 010 100 S04	1	3	10	60	4								
2DEM 010 150 S04	1	3	15	60	4								
2DEM 010 200 S04	1	3	20	60	4								
2DEM 010 250 S04	1	3	25	60	4								
2DEM 010 300 S04	1	3	30	60	4								
2DEM 015 060 S04	1.5	6	-	60	4								
2DEM 015 100 S04	1.5	6	10	60	4								
2DEM 015 150 S04	1.5	6	15	60	4								
2DEM 015 200 S04	1.5	6	20	60	4								
2DEM 015 250 S04	1.5	6	25	60	4								
2DEM 015 300 S04	1.5	6	30	60	4								
2DEM 020 060 S04	2	6	-	45	4								
2DEM 020 080 S04	2	8	-	80	4								
2DEM 020 120 S04	2	8	12	80	4								
2DEM 020 150 S04	2	8	15	80	4								
2DEM 020 200 S04	2	8	20	80	4								
2DEM 020 250 S04	2	8	25	80	4								
2DEM 020 300 S04	2	8	30	80	4								
2DEM 020 400 S04	2	8	40	80	4								
2DEM 020 450 S04	2	8	45	80	4								
2DEM 020 500 S04	2	8	50	80	4								
2DEM 030 090 S06	3	9	-	50	6								
2DEM 030 120 S04	3	12	-	80	4								
2DEM 030 200 S04	3	12	20	80	4								
2DEM 030 250 S04	3	12	25	80	4								
2DEM 030 300 S04	3	12	30	80	4								
2DEM 030 400 S04	3	12	40	80	4								
2DEM 030 500 S04	3	12	50	80	4								

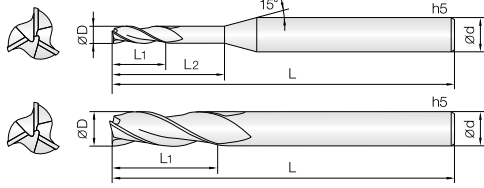

- 그래파이트(흑연), 강화플라스틱, 탄소섬유 등 비철, 비금속 계열의 다양한 피삭재 전용 엔드밀
- CVD 순수다이아몬드 코팅을 적용하여 내마모성이 우수합니다.
- 다양한 피삭재의 형상에 적용하도록 규격을 다양화하여, 넓은 가공 영역에 뛰어난 수명과 성능을 발휘합니다.
- Endmills for Graphite, reinforced plastics, carbon fiber, Non-ferrous and non-metallic materials.
- Excellent wear resistance by applying qualified CVD diamond coating.
- Wide range products prepared for various work shape and excellent performance.



Shield Edge 472P

D Size	D Tolerance
ø1 ~ 12	+0 ~ -0.02mm

단위 : mm

FOR GRAPHITE

Order Number	날경 Diameter D	날장 Length of cut L1	유효장 Effective Length L2	전장 Overall Length L	샤프트 Shank Dia d	비고	Order Number	날경 Diameter D	날장 Length of cut L1	유효장 Effective Length L2	전장 Overall Length L	샤프트 Shank Dia d	비고
3DEM 010 030 S04	1	3	-	45	4								
3DEM 010 050 S04	1	3	5	45	4								
3DEM 010 100 S04	1	3	10	45	4								
3DEM 010 150 S04	1	3	15	45	4								
3DEM 015 060 S04	1.5	6	-	60	4								
3DEM 015 100 S04	1.5	6	10	60	4								
3DEM 015 150 S04	1.5	6	15	60	4								
3DEM 015 200 S04	1.5	6	20	60	4								
3DEM 020 060 S04	2	6	-	45	4								
3DEM 020 100 S04	2	10	10	60	4								
3DEM 020 150 S04	2	10	15	60	4								
3DEM 020 200 S04	2	10	20	60	4								
3DEM 020 250 S04	2	10	25	60	4								
3DEM 030 090 S06	3	9	-	50	6								
3DEM 030 150 S03	3	15	-	60	3								
3DEM 030 150 S04	3	15	-	60	4								
3DEM 030 200 S04	3	15	20	60	4								
3DEM 030 250 S04	3	15	25	60	4								
3DEM 040 120 S06	4	12	-	50	6								
3DEM 040 200 080	4	20	-	80	4								
3DEM 060 180 060	6	18	-	60	6								
3DEM 060 250 110	6	25	-	110	6								
3DEM 060 250 150	6	25	-	150	6								
3DEM 080 240 070	8	24	-	70	8								
3DEM 080 350 110	8	35	-	110	8								
3DEM 080 350 150	8	35	-	150	8								
3DEM 100 250 080	10	25	-	80	10								
3DEM 100 400 110	10	40	-	110	10								
3DEM 100 500 160	10	50	-	160	10								
3DEM 120 250 080	12	25	-	80	12								
3DEM 120 450 110	12	45	-	110	12								
3DEM 120 550 160	12	55	-	160	12								

# 4&6DEM

## 4&6 Flutes Diamond Coated End Mills for Graphite

### 4&6날 흑연가공용 다이아몬드 코팅 엔드밀

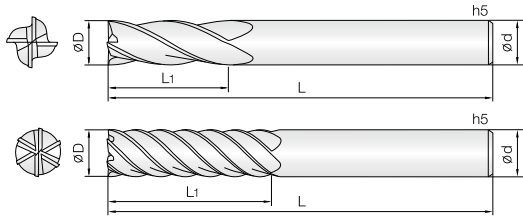

- 그래파이트 (흑연), 강화플라스틱, 탄소섬유 등 비철, 비금속 계열의 다양한 피삭재 전용 엔드밀
- CVD 순수다이아몬드 코팅을 적용하여 내마모성이 우수합니다.
- 다양한 피삭재의 형상에 적용하도록 규격을 다양화하여, 넓은 가공 영역에 뛰어난 수명과 성능을 발휘합니다.
- Endmills for Graphite, reinforced plastics, carbon fiber, Non-ferrous and non-metallic materials.
- Excellent wear resistance by applying qualified CVD diamond coating.
- Wide range products prepared for various work shape and excellent performance.

<b>4</b>	<b>6</b>	<b>WC</b> 미립자	<b>DIA.</b> Coating	<b>30°</b> Helix Angle	<b>45°</b> Helix Angle	<b>Shield Edge</b>	<b>CUTTING DATA</b>
				4F	6F		472P

D Size	D Tolerance
ø2 ~ 16	+0 ~ -0.02mm

단위 : mm

Order Number	날경 Diameter D	날장 Length of cut L1	전장 Overall Length L	생크 Shank Dia d	비고	Order Number	날경 Diameter D	날장 Length of cut L1	전장 Overall Length L	생크 Shank Dia d	비고
4DEM 020 060 S04	2	6	45	4		6DEM 100 400 110	10	40	110	10	
4DEM 020 100 S04	2	10	60	4		6DEM 100 400 160	10	40	160	10	
4DEM 030 090 S06	3	9	50	6		6DEM 120 450 110	12	45	110	12	
4DEM 030 150 S03	3	15	60	3		6DEM 120 450 160	12	45	160	12	
4DEM 030 150 S04	3	15	60	4		6DEM 160 500 110	16	50	110	16	
4DEM 040 120 S06	4	12	50	6		6DEM 160 500 160	16	50	160	16	
4DEM 040 200 080	4	20	80	4		6DEM 160 500 200	16	50	200	16	
4DEM 040 200 100	4	20	100	4							
4DEM 060 180 060	6	18	60	6							
4DEM 060 250 110	6	25	110	6							
4DEM 060 250 150	6	25	150	6							
4DEM 080 240 070	8	24	70	8							
4DEM 080 350 110	8	35	110	8							
4DEM 080 350 150	8	35	150	8							
4DEM 100 250 080	10	25	80	10							
4DEM 100 400 110	10	40	110	10							
4DEM 100 500 160	10	50	160	10							
4DEM 120 250 080	12	25	80	12							
4DEM 120 450 110	12	45	110	12							
4DEM 120 550 160	12	55	160	12							

FOR GRAPHITE







단위 : mm

Order Number	날경 Diameter D×R	날장 Length of cut L1	유효장 Effective Length L2	전장 Overall Length L	생크 Shank Dia d	비고	Order Number	날경 Diameter D×R	날장 Length of cut L1	유효장 Effective Length L2	전장 Overall Length L	생크 Shank Dia d	비고
2DCR 030 002 040	3 X R0.2	4	-	80	4		2DCR 060 0005 300	6 X R0.05	7	30	110	6	
2DCR 030 002 100	3 X R0.2	4	10	80	4		2DCR 060 0005 500	6 X R0.05	7	50	110	6	
2DCR 030 002 200	3 X R0.2	4	20	80	4		2DCR 060 002 070	6 X R0.2	7	-	110	6	
2DCR 030 002 300	3 X R0.2	4	30	80	4		2DCR 060 002 200	6 X R0.2	7	20	110	6	
2DCR 030 002 400	3 X R0.2	4	40	80	4		2DCR 060 002 300	6 X R0.2	7	30	110	6	
2DCR 030 003 040	3 X R0.3	4	-	80	4		2DCR 060 002 500	6 X R0.2	7	50	110	6	
2DCR 030 003 100	3 X R0.3	4	10	80	4		2DCR 060 005 070	6 X R0.5	7	-	110	6	
2DCR 030 003 200	3 X R0.3	4	20	80	4		2DCR 060 005 200	6 X R0.5	7	20	110	6	
2DCR 030 003 300	3 X R0.3	4	30	80	4		2DCR 060 005 300	6 X R0.5	7	30	110	6	
2DCR 030 003 400	3 X R0.3	4	40	80	4		2DCR 060 005 500	6 X R0.5	7	50	110	6	
2DCR 030 005 040	3 X R0.5	4	-	80	4		2DCR 060 010 070	6 X R1	7	-	110	6	
2DCR 030 005 100	3 X R0.5	4	10	80	4		2DCR 060 010 200	6 X R1	7	20	110	6	
2DCR 030 005 200	3 X R0.5	4	20	80	4		2DCR 060 010 300	6 X R1	7	30	110	6	
2DCR 030 005 300	3 X R0.5	4	30	80	4		2DCR 060 010 500	6 X R1	7	50	110	6	
2DCR 030 005 400	3 X R0.5	4	40	80	4								
2DCR 030 010 040	3 X R1	4	-	80	4								
2DCR 030 010 100	3 X R1	4	10	80	4								
2DCR 030 010 200	3 X R1	4	20	80	4								
2DCR 030 010 300	3 X R1	4	30	80	4								
2DCR 030 010 400	3 X R1	4	40	80	4								
2DCR 040 0005 050	4 X R0.05	5	-	80	4								
2DCR 040 0005 150	4 X R0.05	5	15	80	4								
2DCR 040 0005 250	4 X R0.05	5	25	80	4								
2DCR 040 0005 400	4 X R0.05	5	40	80	4								
2DCR 040 002 050	4 X R0.2	5	-	80	4								
2DCR 040 002 150	4 X R0.2	5	15	80	4								
2DCR 040 002 250	4 X R0.2	5	25	80	4								
2DCR 040 002 400	4 X R0.2	5	40	80	4								
2DCR 040 005 050	4 X R0.5	5	-	80	4								
2DCR 040 005 150	4 X R0.5	5	15	80	4								
2DCR 040 005 250	4 X R0.5	5	25	80	4								
2DCR 040 005 400	4 X R0.5	5	40	80	4								
2DCR 040 010 050	4 X R1	5	-	80	4								
2DCR 040 010 150	4 X R1	5	15	80	4								
2DCR 040 010 250	4 X R1	5	25	80	4								
2DCR 040 010 400	4 X R1	5	40	80	4								
2DCR 050 0005 060	5 X R0.05	6	-	110	6								
2DCR 050 0005 150	5 X R0.05	6	15	110	6								
2DCR 050 0005 300	5 X R0.05	6	30	110	6								
2DCR 050 0005 500	5 X R0.05	6	50	110	6								
2DCR 050 002 060	5 X R0.2	6	-	110	6								
2DCR 050 002 150	5 X R0.2	6	15	110	6								
2DCR 050 002 300	5 X R0.2	6	30	110	6								
2DCR 050 002 500	5 X R0.2	6	50	110	6								
2DCR 050 005 060	5 X R0.2	6	-	110	6								
2DCR 050 005 150	5 X R0.2	6	15	110	6								
2DCR 050 005 300	5 X R0.2	6	30	110	6								
2DCR 050 005 500	5 X R0.2	6	50	110	6								
2DCR 060 0005 070	6 X R0.05	7	-	110	6								
2DCR 060 0005 200	6 X R0.05	7	20	110	6								



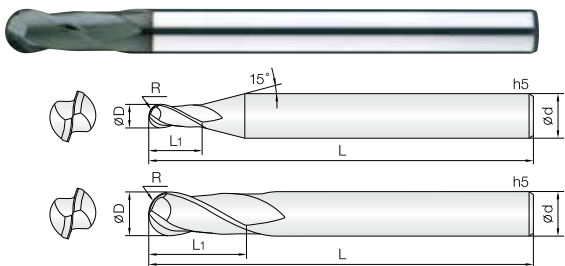

- 강화플라스틱 (CFRP, GFRP), 유리/탄소섬유 등 비철, 비금속 계열의 다양한 복합소재 전용 엔드밀
- 다양한 복합소재 가공영역에 뛰어난 성능을 발휘합니다.
- 코팅피막에 경도가 높아 내마모성이 우수합니다.
- 마찰계수가 낮은 다이아몬드 코팅을 적용하여 흡착현상을 최소화 하였습니다.
- Endmills for CFRP, GFRP, glass/carbon fiber, nonferrous and non-metallic materials
- Outstanding performance in machining of various composite materials.
- Excellent wear resistance by applying high hardness coating layer.
- Minimize built up edge by low friction diamond coating technology.

**2** 미립자
**WC** 미립자
**NANO DIA. Coating**
**R** ± 0.005
**R** ± 0.01
**30° Helix Angle**
**CUTTING DATA**

0.25 ~ 0.5R 0.75 ~ 6R 473P

D Size	D Tolerance
∅ 0.5 ~ 1	+0 ~ -0.01mm
∅ 1.5 ~ 12	-0.005 ~ -0.02mm

단위 : mm

Order Number	날경 Diameter R × D	날장 Length of cut L1	전장 Overall Length L	샙크 Shank Dia d	비고
2CPB 005 010 S04	0.25R X 0.5	1	50	4	
2CPB 006 012 S04	0.3R X 0.6	1.2	50	4	
2CPB 008 020 S04	0.4R X 0.8	2	50	4	
2CPB 010 025 S04	0.5R X 1	2.5	50	4	
2CPB 015 040 S04	0.75R X 1.5	4	50	4	
2CPB 020 050 S04	1R X 2	5	50	4	
2CPB 025 060 S04	1.25R X 2.5	6	50	4	
2CPB 030 080 S06	1.5R X 3	8	60	6	
2CPB 040 080 S06	2R X 4	8	70	6	
2CPB 050 100 S06	2.5R X 5	10	80	6	
2CPB 060 120 080	3R X 6	12	80	6	
2CPB 060 120 110	3R X 6	12	110	6	

Order Number	날경 Diameter R × D	날장 Length of cut L1	전장 Overall Length L	샙크 Shank Dia d	비고
2CPB 080 140 080	4R X 8	14	80	8	
2CPB 080 140 110	4R X 8	14	110	8	
2CPB 100 180 080	5R X 10	18	80	10	
2CPB 100 180 110	5R X 10	18	110	10	
2CPB 120 220 080	6R X 12	22	80	12	
2CPB 120 220 110	6R X 12	22	110	12	

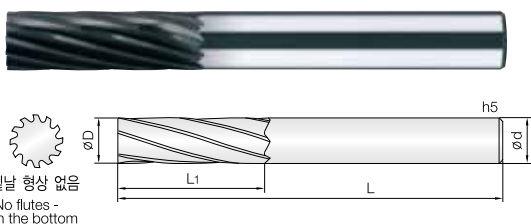

- 강화플라스틱 (CFRP, GFRP), 유리/탄소섬유, 그래파이트(흑연) 등 비철 비금속 계열의 다양한 복합소재 전용 엔드밀
- 다양한 복합소재 가공영역에 뛰어난 성능을 발휘합니다.
- 코팅피막에 경도가 높아 내마모성이 우수합니다.
- 마찰계수가 낮은 다이아몬드 코팅을 적용하여 흡착현상을 최소화 하였습니다.
- Endmills for CFRP, GFRP, glass/carbon fiber, graphite, non-ferrous and non-metallic materials
- Outstanding performance in machining of various composite materials.
- Excellent wear resistance by applying high hardness coating layer.
- Minimize built up edge by low friction diamond coating technology.

**8** ~ **12**
**WC** 미립자
**NANO DIA. Coating**
**15° Helix Angle**
**CUTTING DATA**

473P

D Size	D Tolerance
∅ 6 ~ 12	-0.01 ~ -0.025mm

단위 : mm

Order Number	날경 Diameter D	날장 Length of cut L1	전장 Overall Length L	샙크 Shank Dia d	비고
8CPE 060 180 080	6	18	80	6	
10CPE 080 240 080	8	24	80	8	
12CPE 100 300 100	10	30	100	10	
12CPE 120 360 100	12	36	100	12	

Order Number	날경 Diameter D	날장 Length of cut L1	전장 Overall Length L	샙크 Shank Dia d	비고

# 3&4&6CPR

3~6Flutes Compression Router for Composite

## 3~6날 복합소재 가공용 라우터

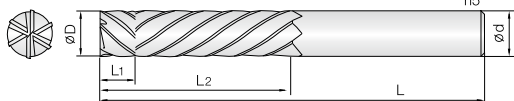

- 강화플라스틱 (CFRP, GFRP), 유리/탄소섬유 등 비철, 비금속 계열의 다양한 복합소재 전용 엔드밀
- 측벽가공시 공작물의 떠올림 현상이 없습니다.
- 피삭재에 버가 발생하지 않습니다.
- 코팅피막의 경도가 높아 내마모성이 우수합니다.
- 마찰계수가 낮은 다이아몬드 코팅을 적용하여 흡착현상을 최소화 하였습니다.

Endmills for CFRP, GFRP, glass/carbon fiber, non-ferrous and non-metallic materials.

- No up-moving work material at wall cutting.
- No burr in work materials.
- Excellent wear resistance by applying high hardness coating layer.
- Minimize built up edge by low friction diamond coating technology.



D Size	D Tolerance
Ø6 ~ 12	-0.01 ~ -0.025mm

단위: mm

Order Number	날경 Diameter D	날장 Length of cut L1	날장 Length of cut L2	전장 Overall Length L	생크 Shank Dia d	비고
3CPR 060 200 S06	6	5	20	70	6	
3CPR 080 250 S08	8	5	25	80	8	
3CPR 100 270 S10	10	6	27	80	10	
3CPR 120 300 S12	12	6	30	80	12	

Order Number	날경 Diameter D	날장 Length of cut L1	날장 Length of cut L2	전장 Overall Length L	생크 Shank Dia d	비고
4CPR 060 200 S06	6	5	20	70	6	
6CPR 080 250 S08	8	5	25	80	8	
6CPR 100 270 S10	10	6	27	80	10	
6CPR 120 300 S12	12	6	30	80	12	

FOR COMPOSITE

# 6~16CPO

6~16Flutes Router for Composite

## 6~16날 복합소재 가공용 라우터

A Type End Teeth (6~16F)



B Type End Teeth (2F)

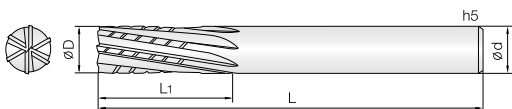

- 강화플라스틱 (CFRP, GFRP), 유리/탄소섬유, 그래파이트 (흑연) 등 비철 비금속 계열의 다양한 복합소재 전용 라우터
- 다양한 복합소재의 황삭가공시 뛰어난 성능을 발휘합니다.
- A type은 밑날의 수가 많아 슬로팅 작업에 최적입니다.
- B type은 밑날이 2날로서 수직 및 수평가공시 탁월한 성능을 발휘합니다.
- 코팅피막의 경도가 높아 내마모성이 우수합니다.
- 마찰계수가 낮은 다이아몬드 코팅을 적용하여 흡착현상을 최소화 하였습니다.

Router for CFRP, GFRP, glass/carbon fiber, graphite, non-ferrous and non-metallic materials

- Outstanding performance in roughing of various composite materials.
- A type has many bottom edges and optimized for slotting.
- B type has two bottom edges and excellent performance in vertical, horizontal machining.
- Excellent wear resistance by applying high hardness coating layer.
- Minimize built up edge by low friction diamond coating technology.



Condition	D Size	D Tolerance	Condition	D Size	D Tolerance
ØD ≠ Ød	Ø2 ~ 5	+0 ~ -0.01mm	ØD = Ød	Ø4 ~ 12	-0.005 ~ -0.02mm

단위: mm

Order Number	날경 Diameter D	날장 Length of cut L1	전장 Overall Length L	타입 Type	생크 Shank Dia d	비고
6CPOA 020 070 S04	2	7	40	A	4	
6CPOB 020 070 S04	2	7	40	B	4	
6CPOA 030 120 S04	3	12	50	A	4	
6CPOB 030 120 S04	3	12	50	B	4	
8CPOA 040 160 S04	4	16	60	A	4	
8CPOB 040 160 S04	4	16	60	B	4	
10CPOA 050 200 S06	5	20	60	A	6	
10CPOB 050 200 S06	5	20	60	B	6	
10CPOA 060 200 S06	6	20	70	A	6	
10CPOB 060 200 S06	6	20	70	B	6	

Order Number	날경 Diameter D	날장 Length of cut L1	전장 Overall Length L	타입 Type	생크 Shank Dia d	비고
12CPOA 080 250 S08	8	25	80	A	8	
12CPOB 080 250 S08	8	25	80	B	8	
14CPOA 100 270 S10	10	27	80	A	10	
14CPOB 100 270 S10	10	27	80	B	10	
16CPOA 120 300 S12	12	30	80	A	12	
16CPOB 120 300 S12	12	30	80	B	12	

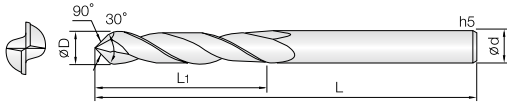

- 강화플라스틱(CFRP,GFRP), 유리/탄소섬유, 동 및 동합금, 그래파이트(흑연) 등 비철, 비금속 계열의 다양한 복합소재 전용 드릴
- 다양한 복합소재 가공영역에 뛰어난 성능을 발휘합니다.
- 코팅피막에 경도가 높아 내마모성이 우수합니다.
- 마찰계수가 낮은 미립 다이아몬드 코팅을 적용, 흡착현상을 최소화 하였습니다.
- Endmills for CFRP, GFRP, glass/carbon fiber, graphite, copper, copper alloys, non-ferrous and non-metallic materials
- Outstanding performance in machining of various composite materials.
- Excellent wear resistance by applying high hardness coating layer.
- Minimize built up edge by low friction diamond coating technology.



475P

Condition	D Size	D Tolerance	Condition	D Size	D Tolerance
øD ≠ ød	ø2 ~ 5	+0 ~ -0.01mm	øD = ød	ø4 ~ 12	-0.005 ~ -0.015mm

단위 : mm

Order Number	날경 Diameter D	날장 Length of cut L1	전장 Overall Length L	생크 Shank Dia d	비고	Order Number	날경 Diameter D	날장 Length of cut L1	전장 Overall Length L	생크 Shank Dia d	비고
2DDCA 020 160 S04	2	16	60	4							
2DDCA 023 180 S04	2.3	18	60	4							
2DDCA 025 200 S04	2.5 X M3	20	60	4							
2DDCA 030 220 S04	3	22	60	4							
2DDCA 033 230 S04	3.3 X M4	23	60	4							
2DDCA 035 270 S04	3.5	27	60	4							
2DDCA 040 300 S04	4	30	60	4							
2DDCA 042 300 S06	4.2 X M5	30	80	6							
2DDCA 045 330 S06	4.5	33	80	6							
2DDCA 050 360 S06	5 X M6	36	80	6							
2DDCA 055 380 S06	5.5	38	80	6							
2DDCA 060 380 S06	6	38	80	6							
2DDCA 065 450 S08	6.5	45	90	8							
2DDCA 068 450 S08	6.8 X M8	45	90	8							
2DDCA 070 450 S08	7	45	90	8							
2DDCA 075 480 S08	7.5	48	90	8							
2DDCA 080 480 S08	8	48	90	8							
2DDCA 085 510 S10	8.5 X M10	51	110	10							
2DDCA 090 540 S10	9	54	110	10							
2DDCA 095 540 S10	9.5	54	110	10							
2DDCA 100 600 S10	10	60	110	10							
2DDCA 103 600 S12	10.3 X M12	60	110	12							
2DDCA 105 600 S12	10.5	60	110	12							
2DDCA 110 650 S12	11	65	110	12							
2DDCA 115 650 S12	11.5	65	110	12							
2DDCA 120 700 S12	12	70	120	12							

FOR COMPOSITE

#### JTOOLS drills benefit (특장점)

버 발생을 최소화한 공구 설계  
Minimize burr by the best drill design

#### Machining Sample



2DDCA type      Other manufacturer



### 4날 45° 헬릭스 SUS가공용 볼 엔드밀

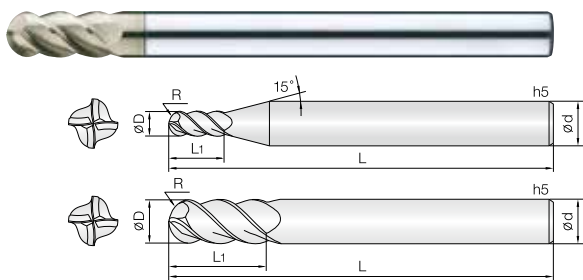

- 합금강, SUS계열, Ti/Ni계 합금, 인코넬 등 난삭재 가공 엔드밀
- JCRO 코팅 처리하여 다양한 피삭재 가공시 인선부에 스트레스가 적으며, 내마모성 또한 향상됩니다.
- 4날 적용과 깊은 포켓으로 칩배출이 원활하며, 피삭재 면조도가 우수합니다.
- 항절력이 높은 미립자 초경합금을 채택하여 고이송 작업시 엔드밀의 파손을 최소화 하였습니다.
- **Endmills for alloy steels, SUS, Ti/Ni base alloys, Inconel and hard-to-cut materials**
- JCRO coating provides wear resistance improvement as well as avoid edge stress in various applications.
- Excellent work surface finish by 4 flute and deep chip pocket.
- Minimize fracturing at high feed by high TRS fine WC grade.

0.5 ~ 2.5R    3 ~ 6R    8R    476P

Condition	D Size	D Tolerance	Condition	D Size	D Tolerance
∅D ≠ ∅d	∅1 ~ 16	+0 ~ -0.01mm	∅D = ∅d	∅6 ~ 12	-0.005 ~ -0.015mm
				∅16	-0.01 ~ -0.02mm

단위 : mm

Order Number	날경 Diameter R x D	날장 Length of cut L1	전장 Overall Length L	생크 Shank Dia d	비고	Order Number	날경 Diameter R x D	날장 Length of cut L1	전장 Overall Length L	생크 Shank Dia d	비고
4SUB 010 025 S06	0.5R X 1	2.5	50	6							
4SUB 015 040 S06	0.75R X 1.5	4	50	6							
4SUB 020 060 S06	1R X 2	6	50	6							
4SUB 030 080 S06	1.5R X 3	8	60	6							
4SUB 040 080 S06	2R X 4	8	70	6							
4SUB 050 100 S06	2.5R X 5	10	80	6							
4SUB 060 120 S06	3R X 6	12	90	6							
4SUB 080 140 S08	4R X 8	14	100	8							
4SUB 100 180 S10	5R X 10	18	100	10							
4SUB 120 220 S12	6R X 12	22	110	12							
4SUB 160 300 S16	8R X 16	30	130	16							

FOR SUS





### 4날 SUS가공용 리브 엔드밀

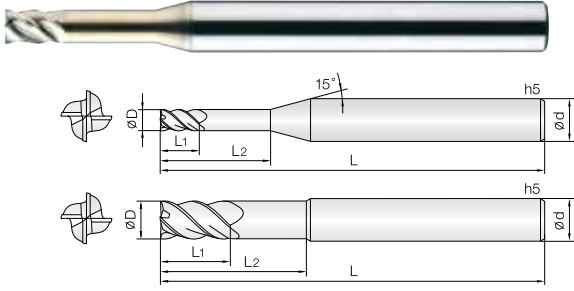

- 합금강, SUS계열, Ti/Ni계 합금, 인코넬 등 난삭재 가공 엔드밀
- J-CRO 코팅 처리하여 다양한 피삭재 가공시 인선부에 스트레스가 적으며, 내마모성 또한 향상됩니다.
- 강력한 채터링방지 설계로 엔드밀의 진동을 최소화하였습니다.
- 4날 적용과 깊은 포켓으로 칩배출이 원활하며, 피삭재 면조도가 우수합니다.
- 항절력이 높은 미립자 초경합금을 채택, 고이송 작업시 엔드밀 파손을 최소화.

#### Endmills for alloy steels, SUS, Ti/Ni base alloys, Inconel and hard-to-cut materials

- JCRO coating provides wear resistance improvement as well as avoid edge stress in various applications.
- Strong design for protection against chattering.
- Excellent work surface finish by 4 flute and deep chip pocket.
- Minimize fracturing at high feed by high TRS fine WC grade.

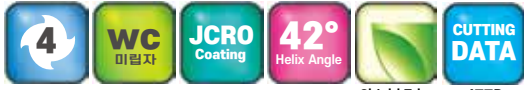

Shield Edge 477P

Condition	D Size	D Tolerance	Condition	D Size	D Tolerance
øD ≠ ød	ø1 ~ 6	+0 ~ -0.01mm	øD = ød	ø6	-0.005 ~ -0.015mm
	ø8 ~ 20	+0 ~ -0.015mm		ø8 ~ 12	-0.01 ~ -0.025mm
		ø16 ~ 20		-0.015 ~ -0.03mm	

단위 : mm

Order Number	날경 Diameter D	날장 Length of cut L1	유효장 Effective Length L2	전장 Overall Length L	생크 Shank Dia d	비고	Order Number	날경 Diameter D	날장 Length of cut L1	유효장 Effective Length L2	전장 Overall Length L	생크 Shank Dia d	비고
4SURE 010 030 S04	1	1.5	3	50	4		4SURE 100 500 S10	10	15	50	100	10	
4SURE 010 050 S04	1	1.5	5	50	4		4SURE 120 360 S12	12	18	36	90	12	
4SURE 010 060 S04	1	1.5	6	50	4		4SURE 120 500 S13	12	18	50	130	12	
4SURE 010 080 S04	1	1.5	8	50	4		4SURE 120 600 S12	12	18	60	110	12	
4SURE 010 100 S04	1	1.5	10	50	4		4SURE 160 480 S16	16	24	48	110	16	
4SURE 012 040 S04	1.2	2	4	50	4		4SURE 160 700 150	16	24	70	150	16	
4SURE 012 060 S04	1.2	2	6	50	4		4SURE 160 800 S16	16	24	80	130	16	
4SURE 012 080 S04	1.2	2	8	50	4		4SURE 200 600 130	20	30	60	130	20	
4SURE 012 100 S04	1.2	2	10	50	4		4SURE 200 1000 160	20	30	100	160	20	
4SURE 015 045 S04	1.5	2.5	4.5	50	4								
4SURE 015 060 S04	1.5	2.5	6	50	4								
4SURE 015 080 S04	1.5	2.5	8	50	4								
4SURE 015 100 S04	1.5	2.5	10	50	4								
4SURE 015 120 S04	1.5	2.5	12	50	4								
4SURE 015 150 S04	1.5	2.5	15	60	4								
4SURE 020 060 S04	2	3	6	50	4								
4SURE 020 080 S04	2	3	8	50	4								
4SURE 020 100 S04	2	3	10	50	4								
4SURE 020 120 S04	2	3	12	50	4								
4SURE 020 140 S04	2	3	14	60	4								
4SURE 020 160 S04	2	3	16	60	4								
4SURE 025 075 S04	2.5	4	7.5	50	4								
4SURE 025 100 S04	2.5	4	10	50	4								
4SURE 025 120 S04	2.5	4	12	50	4								
4SURE 025 140 S04	2.5	4	14	60	4								
4SURE 025 160 S04	2.5	4	16	60	4								
4SURE 030 090 S06	3	4.5	9	60	6								
4SURE 030 120 S06	3	4.5	12	60	6								
4SURE 030 160 S06	3	4.5	16	60	6								
4SURE 030 200 S06	3	4.5	20	60	6								
4SURE 030 250 S06	3	4.5	25	65	6								
4SURE 030 300 S06	3	4.5	30	75	6								
4SURE 040 120 S06	4	6	12	60	6								
4SURE 040 160 S06	4	6	16	60	6								
4SURE 040 200 S06	4	6	20	60	6								
4SURE 040 250 S06	4	6	25	65	6								
4SURE 040 300 S06	4	6	30	75	6								
4SURE 050 150 S06	5	7.5	15	60	6								
4SURE 050 180 100	5	7.5	18	100	6								
4SURE 050 200 S06	5	7.5	20	60	6								
4SURE 050 250 S06	5	7.5	25	65	6								
4SURE 050 300 S06	5	7.5	30	70	6								
4SURE 060 200 S06	6	9	20	60	6								
4SURE 060 250 100	6	9	25	100	6								
4SURE 060 300 S06	6	9	30	70	6								
4SURE 080 250 S08	8	12	25	70	8								
4SURE 080 350 110	8	12	35	110	8								
4SURE 080 400 S08	8	12	40	80	8								
4SURE 100 300 S10	10	15	30	80	10								
4SURE 100 400 120	10	15	40	120	10								

FOR SUS

# 4SUE 4 Flutes Non Symmetry End Mills for SUS

## 4날 SUS가공용 엔드밀

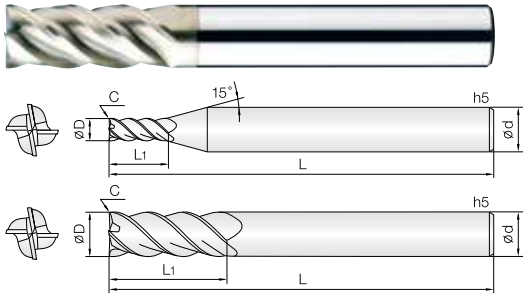

- 합금강, SUS계열, Ti/Ni계 합금, 인코넬 등 난삭재 가공 엔드밀
  - J-CRO 코팅 처리하여 다양한 피삭재 가공시 인선부에 스트레스가 적으며, 내마모성 또한 향상됩니다.
  - 강력한 채터링방지 설계로 엔드밀의 진동을 최소화하였습니다.
  - 4날 적용과 깊은 포켓으로 칩배출이 원활하며, 피삭재 면조도가 우수합니다.
  - 항절력이 높은 미립자 초경합금을 채택, 고이송 작업시 엔드밀 파손을 최소화.
- Endmills for alloy steels, SUS, Ti/Ni base alloys, Inconel and hard-to-cut materials
  - JCRO coating provides wear resistance improvement as well as avoid edge stress in various applications.
  - Strong design for protection against chattering.
  - Excellent work surface finish by 4 flute and deep chip pocket.
  - Minimize fracturing at high feed by high TRS fine WC grade.

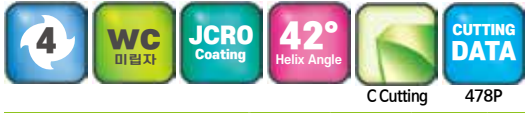

Condition	D Size	D Tolerance	Condition	D Size	D Tolerance
øD ≠ ød	ø0.3 ~ 6	+0 ~ -0.01mm	øD = ød	ø6	-0.005 ~ -0.015mm
	ø7 ~ 20	+0 ~ -0.015mm		ø8 ~ 12	-0.01 ~ -0.025mm
				ø14 ~ 20	-0.015 ~ -0.03mm

단위 : mm

Order Number	날경 Diameter D	날장 Length of cut L1	면취량 Chamfer C	전장 Overall Length L	샙크 Shank Dia d	비고
New 4SUE 003 006 S04	0.3	0.6	0.03	40	4	
New 4SUE 004 008 S04	0.4	0.8	0.04	40	4	
New 4SUE 005 008 S04	0.5	0.8	0.05	40	4	
New 4SUE 005 010 S04	0.5	1	0.05	40	4	
New 4SUE 006 009 S04	0.6	0.9	0.06	40	4	
New 4SUE 006 012 S04	0.6	1.2	0.06	40	4	
New 4SUE 008 012 S04	0.8	1.2	0.08	40	4	
New 4SUE 008 020 S04	0.8	2	0.08	40	4	
4SUE 010 015 S04	1	1.5	0.01	50	4	
4SUE 010 025 S04	1	2.5	0.01	50	4	
4SUE 010 035 S04	1	3.5	0.01	50	4	
4SUE 010 050 S04	1	5	0.01	50	4	
4SUE 010 060 S04	1	6	0.01	50	4	
4SUE 012 015 S04	1.2	1.5	0.012	50	4	
4SUE 012 030 S04	1.2	3	0.012	50	4	
4SUE 012 050 S04	1.2	5	0.012	50	4	
4SUE 012 070 S04	1.2	7	0.012	50	4	
4SUE 015 025 S04	1.5	2.5	0.012	50	4	
4SUE 015 040 S04	1.5	4	0.012	50	4	
4SUE 015 055 S04	1.5	5.5	0.012	50	4	
4SUE 015 070 S04	1.5	7	0.012	50	4	
4SUE 015 085 S04	1.5	8.5	0.012	50	4	
4SUE 020 030 S04	2	3	0.02	50	4	
4SUE 020 060 S04	2	6	0.02	50	4	
4SUE 020 080 S04	2	8	0.02	50	4	
4SUE 020 100 S04	2	10	0.02	50	4	
4SUE 020 120 S04	2	12	0.02	50	4	
4SUE 020 140 S04	2	14	0.02	50	4	
4SUE 025 035 S04	2.5	3.5	0.025	50	4	
4SUE 025 080 S04	2.5	8	0.025	50	4	
4SUE 025 100 S04	2.5	10	0.025	50	4	
4SUE 025 120 S04	2.5	12	0.025	50	4	
4SUE 025 140 S04	2.5	14	0.025	50	4	
4SUE 030 045 S06	3	4.5	0.03	60	6	
4SUE 030 100 S06	3	10	0.03	60	6	
4SUE 030 120 S06	3	12	0.03	60	6	
4SUE 030 150 S06	3	15	0.03	60	6	
4SUE 030 200 S06	3	20	0.03	70	6	
4SUE 030 250 S06	3	25	0.03	70	6	
4SUE 030 300 S06	3	30	0.03	75	6	
4SUE 035 055 S06	3.5	5.5	0.035	60	6	
4SUE 035 100 S06	3.5	10	0.035	60	6	
4SUE 035 150 S06	3.5	15	0.035	60	6	
4SUE 035 200 S06	3.5	20	0.035	60	6	
4SUE 040 060 S06	4	6	0.04	60	6	
4SUE 040 120 S06	4	12	0.04	60	6	
4SUE 040 160 S06	4	16	0.04	60	6	
4SUE 040 200 S06	4	20	0.04	70	6	
4SUE 040 250 S06	4	25	0.04	70	6	
4SUE 040 300 S06	4	30	0.04	75	6	

Order Number	날경 Diameter D	날장 Length of cut L1	면취량 Chamfer C	전장 Overall Length L	샙크 Shank Dia d	비고
4SUE 045 070 S06	4.5	7	0.045	60	6	
4SUE 045 130 S06	4.5	13	0.045	60	6	
4SUE 045 180 S06	4.5	18	0.045	60	6	
4SUE 050 075 S06	5	7.5	0.05	60	6	
4SUE 050 150 S06	5	15	0.05	60	6	
4SUE 050 200 S06	5	20	0.05	70	6	
4SUE 050 250 S06	5	25	0.05	70	6	
4SUE 050 300 S06	5	30	0.05	75	6	
4SUE 060 090 S06	6	9	0.06	60	6	
4SUE 060 150 S06	6	15	0.06	60	6	
4SUE 060 180 S06	6	18	0.06	65	6	
4SUE 060 250 S06	6	25	0.06	70	6	
4SUE 060 300 S06	6	30	0.06	70	6	
4SUE 060 400 S06	6	40	0.06	80	6	
4SUE 070 110 S08	7	11	0.07	70	8	
4SUE 070 180 S08	7	18	0.07	70	8	
4SUE 070 210 S08	7	21	0.07	70	8	
4SUE 080 120 S08	8	12	0.08	70	8	
4SUE 080 200 S08	8	20	0.08	70	8	
4SUE 080 240 S08	8	24	0.08	70	8	
4SUE 080 300 S08	8	30	0.08	80	8	
4SUE 080 400 S08	8	40	0.08	90	8	
4SUE 080 500 S08	8	50	0.08	100	8	
4SUE 090 140 S10	9	14	0.09	80	10	
4SUE 090 220 S10	9	22	0.09	80	10	
4SUE 090 270 S10	9	27	0.09	80	10	
4SUE 100 150 S10	10	15	0.1	80	10	
4SUE 100 250 S10	10	25	0.1	80	10	
4SUE 100 300 S10	10	30	0.1	80	10	
4SUE 100 400 S10	10	40	0.1	90	10	
4SUE 100 500 S10	10	50	0.1	100	10	
4SUE 100 600 S10	10	60	0.1	110	10	
4SUE 110 170 S12	11	17	0.11	90	12	
4SUE 110 220 S12	11	22	0.11	90	12	
4SUE 110 330 S12	11	33	0.11	90	12	
4SUE 120 180 S12	12	18	0.12	90	12	
4SUE 120 300 S12	12	30	0.12	90	12	
4SUE 120 360 S12	12	36	0.12	90	12	
New 4SUE 120 450 S12	12	45	0.12	100	12	
4SUE 120 500 S12	12	50	0.12	100	12	
4SUE 120 600 S12	12	60	0.12	110	12	
4SUE 120 700 S12	12	70	0.12	120	12	
New 4SUE 140 320 S14	14	32	0.14	100	14	
New 4SUE 140 450 S14	14	45	0.14	100	14	
New 4SUE 140 600 S14	14	60	0.14	110	14	
New 4SUE 140 700 S14	14	70	0.14	120	14	
4SUE 160 240 S16	16	24	0.16	100	16	
4SUE 160 350 S16	16	35	0.16	100	16	
4SUE 160 500 S16	16	50	0.16	110	16	
4SUE 160 700 S16	16	70	0.16	130	16	

# 4SUE 4 Flutes Non Symmetry End Mills for SUS

## 4날 SUS가공용 엔드밀

단위 : mm

Order Number	날경 Diameter D	날장 Length of cut L1	면취량 Chamfer C	전장 Overall Length L	생크 Shank Dia d	비고	Order Number	날경 Diameter D	날장 Length of cut L1	면취량 Chamfer C	전장 Overall Length L	생크 Shank Dia d	비고
4SUE 160 900 S16	16	90	0.16	150	16								
4SUE 200 300 S20	20	30	0.2	100	20								
4SUE 200 400 S20	20	40	0.2	100	20								
4SUE 200 600 S20	20	60	0.2	120	20								
4SUE 200 800 S20	20	80	0.2	150	20								
4SUE 200 1000 S20	20	100	0.2	160	20								

FOR SUS

# 4SUV 4 Flutes Variable Helix End Mills for SUS

## 4날 SUS 강력절삭용 엔드밀

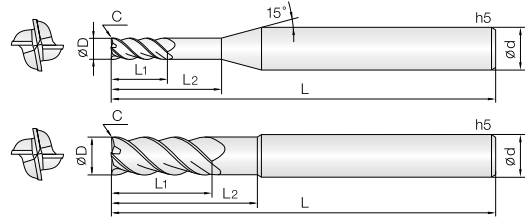

- 합금강, SUS계열, Ti/Ni계 합금, 인코넬 등 난삭재 가공 엔드밀
  - JCRO 코팅 처리하여 인선부에 스트레스가 적으며, 내마모성 또한 향상됩니다.
  - 부등분할 밀날방식과 가변 헬릭스 인선설계로, 채터링이 더욱 감소 하였습니다.
  - A타입은 엔드밀의 치핑을 최소화, B타입은 칩배출을 극대화 하였습니다.
  - 항절력이 높은 미립자 초경합금을 채택하여, 고이송 작업시 엔드밀의 파손을 최소화.
- Endmills for alloy steels, SUS, Ti/Ni base alloys, Inconel and hard-to-cut materials
  - JCRO coating provides wear resistance improvement as well as avoid edge stress in various applications.
  - Minimize chattering during cutting application by unequal index of flute and helix angle to the endmill edge.
  - Type A minimizes chipping, Type B maximizes chip emissins.
  - Minimize fracturing at high feed by high TRS fine WC grade.

4 WC 미립자 JCRO Coating 35° Helix Angle 38° Helix Angle A Shield Edge B Sharp Edge CUTTING DATA 478P

Condition	D Size	D Tolerance	Condition	D Size	D Tolerance
øD ≠ ød	ø1 ~ 6	+0 ~ -0.01mm	øD = ød	ø6	-0.005 ~ -0.015mm
	ø8 ~ 20	+0 ~ -0.015mm		ø8 ~ 12	-0.01 ~ -0.025mm
		ø14 ~ 20		-0.015 ~ -0.03mm	

단위 : mm

Order Number	날경 Diameter D	날장 Length of cut L1	유효장 Effective Length L2	면취타입 Type	전장 Overall Length L	샙크 Shank Dia d	비고	Order Number	날경 Diameter D	날장 Length of cut L1	유효장 Effective Length L2	면취타입 Type	전장 Overall Length L	샙크 Shank Dia d	비고
4SUVA 010 025 S04	1	2.5	-	A	50	4									
4SUVB 010 025 S04	1	2.5	-	B	50	4									
4SUVA 010 060 S04	1	2.5	6	A	50	4									
4SUVA 015 040 S04	1.5	4	-	A	50	4									
4SUVB 015 040 S04	1.5	4	-	B	50	4									
4SUVA 015 100 S04	1.5	4	10	A	50	4									
4SUVA 020 050 S04	2	5	-	A	50	4									
4SUVB 020 050 S04	2	5	-	B	50	4									
4SUVA 020 120 S04	2	5	12	A	50	4									
4SUVA 030 080 S06	3	8	-	A	60	6									
4SUVB 030 080 S06	3	8	-	B	60	6									
4SUVA 030 180 S06	3	8	18	A	60	6									
4SUVA 040 110 S06	4	11	-	A	60	6									
4SUVB 040 110 S06	4	11	-	B	60	6									
4SUVA 040 210 S06	4	11	21	A	60	6									
4SUVA 050 130 S06	5	13	-	A	60	6									
4SUVB 050 130 S06	5	13	-	B	60	6									
4SUVA 050 210 S06	5	13	21	A	60	6									
4SUVA 060 130 S06	6	13	-	A	60	6									
4SUVB 060 130 S06	6	13	-	B	60	6									
4SUVA 060 210 S06	6	13	21	A	60	6									
4SUVA 080 190 S08	8	19	-	A	60	8									
4SUVB 080 190 S08	8	19	-	B	60	8									
4SUVA 080 270 S08	8	19	27	A	60	8									
4SUVA 100 220 S10	10	22	-	A	70	10									
4SUVB 100 220 S10	10	22	-	B	70	10									
4SUVA 100 320 S10	10	22	32	A	70	10									
4SUVA 120 260 S12	12	26	-	A	80	12									
4SUVB 120 260 S12	12	26	-	B	80	12									
4SUVA 120 380 S12	12	26	38	A	80	12									
New 4SUVA 140 300 S14	14	30	-	A	90	14									
New 4SUVB 140 300 S14	14	30	-	B	90	14									
New 4SUVA 140 420 S14	14	30	42	A	90	14									
4SUVA 160 320 S16	16	32	-	A	90	16									
4SUVB 160 320 S16	16	32	-	B	90	16									
4SUVA 160 450 S16	16	32	45	A	90	16									
4SUVA 200 380 S20	20	38	-	A	100	20									
4SUVB 200 380 S20	20	38	-	B	100	20									
4SUVA 200 550 S20	20	38	55	A	100	20									

FOR SUS

### 4날 SUS가공용 리브 코너 레디우스 엔드밀

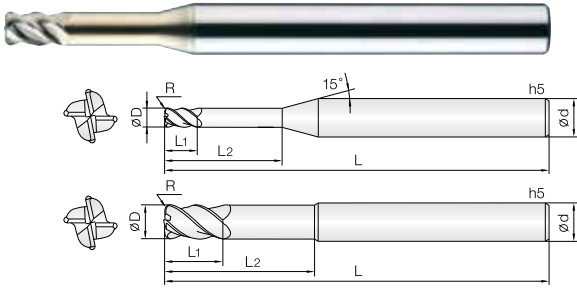

- 합금강, SUS계열, Ti/Ni계 합금, 인코넬 등 난삭재 가공 엔드밀
- J-CRO 코팅 처리하여 다양한 피삭재 가공시 인선부에 스트레스가 적으며, 내마모성 또한 향상됩니다.
- 강력한 채터링방지 설계로 엔드밀의 진동을 최소화하였습니다.
- 4날 적용과 깊은 포켓으로 칩배출이 원활하며, 피삭재 면조도가 우수합니다.
- 항절삭력이 높은 미립자 초경합금을 채택, 고이송 작업시 엔드밀 파손을 최소화.

#### • Endmills for alloy steels, SUS, Ti/Ni base alloys, Inconel and hard-to-cut materials.

- JCRO coating provides wear resistance improvement as well as avoid edge stress in various applications.
- Strong design for protection against chattering.
- Excellent work surface finish by 4 flute and deep chip pocket.
- Minimize fracturing at high feed by high TRS fine WC grade.



Condition	D Size	D Tolerance
ØD ≠ Ød	Ø1 ~ 20	+0 ~ -0.01mm

Condition	D Size	D Tolerance
ØD = Ød	Ø6 ~ 12	-0.005 ~ -0.015mm
	Ø16 ~ 20	-0.01 ~ -0.02mm

단위 : mm

Order Number	날경 Diameter D×R	날장 Length of cut L1	유효장 Effective Length L2	전장 Overall Length L	생크 Shank Dia d	비고
4SUCR 010 001 050	1 X R0.1	1.5	5	60	4	
4SUCR 010 001 060	1 X R0.1	1.5	6	60	4	
4SUCR 010 001 080	1 X R0.1	1.5	8	60	4	
4SUCR 020 001 100	2 X R0.1	3	10	60	4	
4SUCR 020 001 120	2 X R0.1	3	12	60	4	
4SUCR 020 001 160	2 X R0.1	3	16	60	4	
4SUCR 020 002 100	2 X R0.2	3	10	60	4	
4SUCR 020 002 120	2 X R0.2	3	12	60	4	
4SUCR 020 002 160	2 X R0.2	3	16	60	4	
4SUCR 030 002 150	3 X R0.2	4.5	15	65	6	
4SUCR 030 002 200	3 X R0.2	4.5	20	70	6	
4SUCR 030 005 150	3 X R0.5	4.5	15	65	6	
4SUCR 030 005 200	3 X R0.5	4.5	20	70	6	
4SUCR 040 002 200	4 X R0.2	6	20	70	6	
4SUCR 040 002 300	4 X R0.2	6	30	80	6	
4SUCR 040 005 200	4 X R0.5	6	20	70	6	
4SUCR 040 005 300	4 X R0.5	6	30	80	6	
4SUCR 040 010 200	4 X R1	6	20	70	6	
4SUCR 050 002 250	5 X R0.2	7.5	25	70	6	
4SUCR 050 002 360	5 X R0.2	7.5	36	80	6	
4SUCR 050 005 250	5 X R0.5	7.5	25	70	6	
4SUCR 050 005 360	5 X R0.5	7.5	36	80	6	
4SUCR 050 010 250	5 X R1	7.5	25	70	6	
4SUCR 060 003 300	6 X R0.3	9	30	70	6	
4SUCR 060 003 400	6 X R0.3	9	40	80	6	
4SUCR 060 005 300	6 X R0.5	9	30	70	6	
4SUCR 060 005 400	6 X R0.5	9	40	80	6	
4SUCR 060 010 300	6 X R1	9	30	70	6	
4SUCR 060 010 400	6 X R1	9	40	80	6	
4SUCR 060 015 300	6 X R1.5	9	30	70	6	
4SUCR 070 003 350	7 X R0.3	10	35	80	8	
4SUCR 070 005 350	7 X R0.5	10	35	80	8	
4SUCR 070 010 350	7 X R1	10	35	80	8	
4SUCR 080 003 400	8 X R0.3	12	40	80	8	
4SUCR 080 005 400	8 X R0.5	12	40	80	8	
4SUCR 080 010 400	8 X R1	12	40	80	8	
4SUCR 080 015 400	8 X R1.5	12	40	80	8	
4SUCR 080 020 400	8 X R2	12	40	80	8	
4SUCR 090 003 450	9 X R0.3	13	45	90	10	
4SUCR 090 005 450	9 X R0.5	13	45	90	10	
4SUCR 090 010 450	9 X R1	13	45	90	10	
4SUCR 100 003 500	10 X R0.3	15	50	100	10	
4SUCR 100 005 500	10 X R0.5	15	50	100	10	
4SUCR 100 010 500	10 X R1	15	50	100	10	
4SUCR 100 015 500	10 X R1.5	15	50	100	10	
4SUCR 100 020 500	10 X R2	15	50	100	10	
4SUCR 110 003 550	11 X R0.3	16	55	100	12	
4SUCR 110 005 550	11 X R0.5	16	55	100	12	
4SUCR 110 010 550	11 X R1	16	55	100	12	
4SUCR 120 003 600	12 X R0.3	18	60	110	12	

Order Number	날경 Diameter D×R	날장 Length of cut L1	유효장 Effective Length L2	전장 Overall Length L	생크 Shank Dia d	비고
4SUCR 120 005 600	12 X R0.5	18	60	110	12	
4SUCR 120 010 600	12 X R1	18	60	110	12	
4SUCR 120 015 600	12 X R1.5	18	60	110	12	
4SUCR 120 020 600	12 X R2	18	60	110	12	
4SUCR 120 025 600	12 X R2.5	18	60	110	12	
4SUCR 120 030 600	12 X R3	18	60	110	12	
4SUCR 160 005 800	16 X R0.5	24	80	130	16	
4SUCR 160 010 800	16 X R1	24	80	130	16	
4SUCR 160 015 800	16 X R1.5	24	80	130	16	
4SUCR 160 020 800	16 X R2	24	80	130	16	
4SUCR 160 030 800	16 X R3	24	80	130	16	
4SUCR 200 005 1000	20 X R0.5	30	100	150	20	
4SUCR 200 010 1000	20 X R1	30	100	150	20	
4SUCR 200 015 1000	20 X R1.5	30	100	150	20	
4SUCR 200 020 1000	20 X R2	30	100	150	20	
4SUCR 200 030 1000	20 X R3	30	100	150	20	
4SUCR 200 050 1000	20 X R5	30	100	150	20	

FOR SUS

### 4날 SUS가공용 코너 레디우스 엔드밀

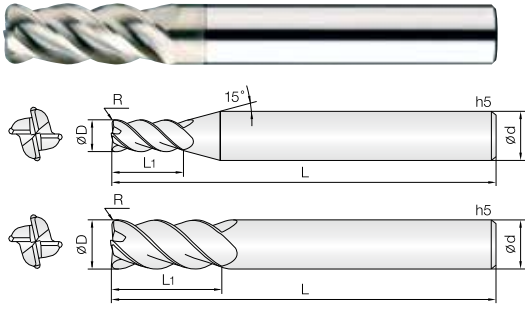

- 합금강, SUS계열, Ti/Ni계 합금, 인코넬 등 난삭재 가공 엔드밀
  - J-CRO 코팅 처리하여 다양한 피삭재 가공시 인선부에 스트레스가 적으며, 내마모성 또한 향상됩니다.
  - 강력한 채터링방지 설계로 엔드밀의 진동을 최소화하였습니다.
  - 코너R부 적용으로 밀날 치핑을 방지 하였습니다.
  - 항절력이 높은 미립자 초경합금을 채택하여, 고이송 작업시 엔드밀의 파손을 최소화.
- Endmills for alloy steel, SUS, Ti/Ni base alloy, Inconel and hard-to-cut materials
  - JCRO coating provides wear resistance improvement as well as avoid edge stress in various applications.
  - Strong design for protection against chattering.
  - Preventing bottom edge chipping by corner R.
  - Minimize fracturing at high feed by high TRS fine WC grade.

<b>4</b>	<b>WC</b> 미립자	<b>JCRO</b> Coating	<b>R</b> ±0.005	<b>R</b> ±0.01	<b>R</b> ±0.015	<b>42°</b> Helix Angle	<b>CUTTING</b> <b>DATA</b>
			R0.1 ~ 0.5	R1 ~ 1.5	R2 ~ 3		478P

Condition	D Size	D Tolerance	Condition	D Size	D Tolerance
$\varnothing D \neq \varnothing d$	$\varnothing 1 \sim 20$	$+0 \sim -0.01\text{mm}$	$\varnothing D = \varnothing d$	$\varnothing 6 \sim 12$	$-0.005 \sim -0.015\text{mm}$
				$\varnothing 14 \sim 20$	$-0.01 \sim -0.02\text{mm}$

단위 : mm

Order Number	날경 Diameter D×R	날장 Length of cut L1	전장 Overall Length L	샙크 Shank Dia d	비고	Order Number	날경 Diameter D×R	날장 Length of cut L1	전장 Overall Length L	샙크 Shank Dia d	비고
4SUC 010 001 S04	1 X R0.1	2.5	50	4		4SUC 080 003 S08	8 X R0.3	20	80	8	
4SUC 010 002 S04	1 X R0.2	2.5	50	4		4SUC 080 005 070	8 X R0.5	16	70	8	
4SUC 012 001 S04	1.2 X R0.1	3	50	4		4SUC 080 005 S08	8 X R0.5	20	80	8	
4SUC 012 002 S04	1.2 X R0.2	3	50	4		4SUC 080 010 070	8 X R1	16	70	8	
4SUC 015 001 S04	1.5 X R0.1	4	50	4		4SUC 080 010 S08	8 X R1	20	80	8	
4SUC 015 002 S04	1.5 X R0.2	4	50	4		4SUC 080 015 S08	8 X R1.5	20	80	8	
4SUC 015 003 S04	1.5 X R0.3	4	50	4		4SUC 080 020 S08	8 X R2	20	80	8	
4SUC 020 001 S04	2 X R0.1	6	50	4		4SUC 085 003 S10	8.5 X R0.3	22	80	10	
4SUC 020 002 S04	2 X R0.2	6	50	4		4SUC 090 003 S10	9 X R0.3	25	80	10	
4SUC 020 003 S04	2 X R0.3	6	50	4		4SUC 100 003 070	10 X R0.3	20	70	10	
4SUC 020 005 S04	2 X R0.5	6	50	4		4SUC 100 003 S10	10 X R0.3	25	80	10	
4SUC 025 001 S04	2.5 X R0.1	7	50	4		4SUC 100 005 070	10 X R0.5	20	70	10	
4SUC 025 002 S04	2.5 X R0.2	7	50	4		4SUC 100 005 S10	10 X R0.5	25	80	10	
4SUC 025 003 S04	2.5 X R0.3	7	50	4		4SUC 100 010 070	10 X R1	20	70	10	
4SUC 030 001 S06	3 X R0.1	10	60	6		4SUC 100 010 S10	10 X R1	25	80	10	
4SUC 030 002 055	3 X R0.2	6	55	6		4SUC 100 015 070	10 X R1.5	20	70	10	
4SUC 030 002 S06	3 X R0.2	10	60	6		4SUC 100 015 S10	10 X R1.5	25	80	10	
4SUC 030 003 S06	3 X R0.3	10	60	6		4SUC 100 020 070	10 X R2	20	70	10	
4SUC 030 005 055	3 X R0.5	6	55	6		4SUC 100 020 S10	10 X R2	25	80	10	
4SUC 030 005 S06	3 X R0.5	10	60	6		4SUC 100 025 070	10 X R2.5	20	70	10	
4SUC 035 002 S06	3.5 X R0.2	10	60	6		4SUC 100 025 S10	10 X R2.5	25	80	10	
4SUC 040 001 S06	4 X R0.1	12	60	6		4SUC 100 030 070	10 X R3	20	70	10	
4SUC 040 002 055	4 X R0.2	8	55	6		4SUC 100 030 S10	10 X R3	25	80	10	
4SUC 040 002 S06	4 X R0.2	12	60	6		4SUC 110 005 S12	11 X R0.5	27	90	12	
4SUC 040 003 S06	4 X R0.3	12	60	6		4SUC 110 010 S12	11 X R1	27	90	12	
4SUC 040 005 055	4 X R0.5	8	55	6		4SUC 120 003 080	12 X R0.3	24	80	12	
4SUC 040 005 S06	4 X R0.5	12	60	6		4SUC 120 003 S12	12 X R0.3	30	100	12	
4SUC 040 010 S06	4 X R1	12	60	6		4SUC 120 005 080	12 X R0.5	24	80	12	
4SUC 045 002 S06	4.5 X R0.2	14	60	6		4SUC 120 005 S12	12 X R0.5	30	100	12	
4SUC 050 002 055	5 X R0.2	10	55	6		4SUC 120 010 080	12 X R1	24	80	12	
4SUC 050 002 S06	5 X R0.2	15	60	6		4SUC 120 010 S12	12 X R1	30	100	12	
4SUC 050 003 S06	5 X R0.3	15	60	6		4SUC 120 015 080	12 X R1.5	24	80	12	
4SUC 050 005 055	5 X R0.5	10	55	6		4SUC 120 015 S12	12 X R1.5	30	100	12	
4SUC 050 005 S06	5 X R0.5	15	60	6		4SUC 120 020 080	12 X R2	24	80	12	
4SUC 050 010 S06	5 X R1	15	60	6		4SUC 120 020 S12	12 X R2	30	100	12	
4SUC 055 002 S06	5.5 X R0.2	15	60	6		4SUC 120 025 S12	12 X R2.5	30	100	12	
New 4SUC 060 002 055	6 X R0.2	12	55	6		4SUC 120 030 080	12 X R3	24	80	12	
New 4SUC 060 002 S06	6 X R0.2	15	60	6		4SUC 120 030 S12	12 X R3	30	100	12	
4SUC 060 003 055	6 X R0.3	12	55	6		4SUC 140 005 S14	14 X R0.5	35	100	14	
4SUC 060 003 S06	6 X R0.3	15	60	6		4SUC 140 010 S14	14 X R1	35	100	14	
4SUC 060 005 055	6 X R0.5	12	55	6		4SUC 160 005 100	16 X R0.5	32	100	16	
4SUC 060 005 S06	6 X R0.5	15	60	6		4SUC 160 005 S16	16 X R0.5	42	110	16	
4SUC 060 010 055	6 X R1	12	55	6		4SUC 160 010 100	16 X R1	32	100	16	
4SUC 060 010 S06	6 X R1	15	60	6		4SUC 160 010 S16	16 X R1	42	110	16	
4SUC 060 015 S06	6 X R1.5	15	60	6		4SUC 180 005 S18	18 X R0.5	45	110	18	
4SUC 065 003 S08	6.5 X R0.3	18	60	8		4SUC 180 010 S18	18 X R1	45	110	18	
4SUC 070 003 S08	7 X R0.3	20	80	8		4SUC 200 005 S20	20 X R0.5	48	110	20	
4SUC 070 005 S08	7 X R0.5	20	80	8		4SUC 200 010 S20	20 X R1	48	110	20	
4SUC 007 010 S08	7 X R1	20	80	8							
4SUC 080 003 070	8 X R0.3	16	70	8							



4날 SUS가공용 긴길이 코너 레디우스 엔드밀

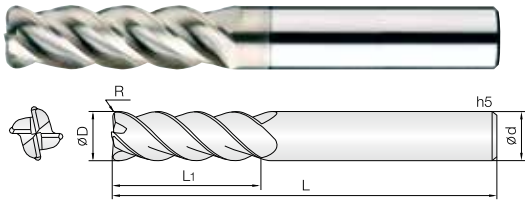

- 합금강, SUS계열, Ti/Ni계합금, 인코넬 등 난삭재 가공 엔드밀
- J-CRO 코팅 처리하여 다양한 피삭재 가공시 인선부에 스트레스가 적으며, 내마모성 또한 향상됩니다.
- 강력한 채터링방지 설계로 엔드밀의 진동을 최소화하였습니다.
- 코너R부 적용으로 밑날 치핑을 방지 하였습니다.
- 항절력이 높은 미립자 초경합금을 채택하여, 고이송 작업시 엔드밀의 파손을 최소화.

• Endmills for alloy steels, SUS, Ti/Ni base alloys, Inconel and hard-to-cut materials

- JCRO coating provides wear resistance improvement as well as avoid edge stress in various applications.
- Strong design for protection against chattering.
- Preventing bottom edge chipping by corner R.
- Minimize fracturing at high feed by high TRS fine WC grade.

Condition	D Size	D Tolerance
ØD ≠ Ød	Ø6 ~ 20	+0 ~ -0.01mm

Condition	D Size	D Tolerance
ØD = Ød	Ø6 ~ 12	-0.005 ~ -0.015mm
	Ø14 ~ 20	-0.01 ~ -0.02mm

단위 : mm

Order Number	날경 Diameter D × R	날장 Length of cut L1	전장 Overall Length L	샙크 Shank Dia d	비고	Order Number	날경 Diameter D × R	날장 Length of cut L1	전장 Overall Length L	샙크 Shank Dia d	비고
4LSUC 060 003 070	6 X R0.3	30	70	6							
4LSUC 060 005 070	6 X R0.5	30	70	6							
4LSUC 060 010 070	6 X R1	30	70	6							
4LSUC 060 015 070	6 X R1.5	30	70	6							
4LSUC 080 003 080	8 X R0.3	40	80	8							
4LSUC 080 005 080	8 X R0.5	40	80	8							
4LSUC 080 010 080	8 X R1	40	80	8							
4LSUC 080 015 080	8 X R1.5	40	80	8							
4LSUC 080 020 080	8 X R2	40	80	8							
4LSUC 100 003 100	10 X R0.3	50	100	10							
4LSUC 100 005 100	10 X R0.5	50	100	10							
4LSUC 100 010 100	10 X R1	50	100	10							
4LSUC 100 015 100	10 X R1.5	50	100	10							
4LSUC 100 020 100	10 X R2	50	100	10							
4LSUC 120 003 120	12 X R0.3	60	120	12							
4LSUC 120 005 120	12 X R0.5	60	120	12							
4LSUC 120 010 120	12 X R1	60	120	12							
4LSUC 120 015 120	12 X R1.5	60	120	12							
4LSUC 120 020 120	12 X R2	60	120	12							
4LSUC 120 025 120	12 X R2.5	60	120	12							
4LSUC 120 030 120	12 X R3	60	120	12							
New 4LSUC 140 005 120	14 X R0.5	70	120	14							
New 4LSUC 140 010 120	14 X R1	70	120	14							
New 4LSUC 140 020 120	14 X R2	70	120	14							
New 4LSUC 140 030 120	14 X R3	70	120	14							
4LSUC 160 005 130	16 X R0.5	80	130	16							
4LSUC 160 010 130	16 X R1	80	130	16							
4LSUC 160 015 130	16 X R1.5	80	130	16							
4LSUC 160 020 130	16 X R2	80	130	16							
4LSUC 160 030 130	16 X R3	80	130	16							
4LSUC 200 005 160	20 X R0.5	100	160	20							
4LSUC 200 010 160	20 X R1	100	160	20							
4LSUC 200 015 160	20 X R1.5	100	160	20							
4LSUC 200 020 160	20 X R2	100	160	20							
4LSUC 200 030 160	20 X R3	100	160	20							

FOR SUS

### 3&4&5날 45° 헬릭스 SUS라핑 코너 R 엔드밀

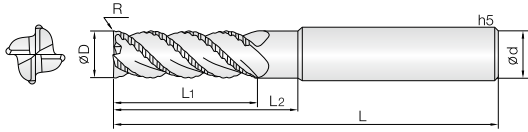

- 합금강, SUS계열, 인코넬, 일반구조강 등 다양한 난삭재의 황삭가공
- JCRO 코팅 처리하여 다양한 피삭재 가공시 인선부에 스트레스가 적으며, 내마모성 또한 향상됩니다.
- 45° 헬릭스 적용으로 절삭 저항이 감소 되어 장시간 가공에 적합합니다.
- 파인피치 형상 채택으로 고속, 황삭가공 작업에 적합합니다.

#### Roughing Endmills for alloy steels, SUS, Inconel, Mild steels and various hard-to-cut materials

- JCRO coating provides wear resistance improvement as well as avoid edge stress in various applications.
- 45 helix Design for minimizing cutting resistance and long time process.
- High speed and roughing work applicable by fine pitch flute.

3

4

5

WC  
미립자

JCRO  
Coating

R  
± 0.005

R  
± 0.01

R  
± 0.015

45°  
Helix Angle

CUTTING  
DATA

R0.2 ~ 0.5    R1 ~ 1.5    R2    480P

D Size	D Tolerance
Ø 3 ~ 9	-0.02 ~ -0.04mm
Ø 10 ~ 20	-0.02 ~ -0.05mm

단위 : mm

Order Number	날경 Diameter D × R	날장 Length of cut L1	유효장 Effective Length L2	전장 Overall Length L	샙크 Shank Dia d	비고	Order Number	날경 Diameter D × R	날장 Length of cut L1	유효장 Effective Length L2	전장 Overall Length L	샙크 Shank Dia d	비고
3SUR 030 002 S06	3 X R0.2	8	-	50	6								
3SUR 040 002 S06	4 X R0.2	10	-	50	6								
4SUR 050 002 S06	5 X R0.2	13	-	50	6								
4SUR 060 002 200	6 X R0.2	10	20	60	6								
4SUR 060 002 S06	6 X R0.2	13	-	60	6								
4SUR 060 005 S06	6 X R0.5	13	-	60	6								
4SUR 070 002 S08	7 X R0.2	18	-	70	8								
4SUR 080 002 250	8 X R0.2	12	25	70	8								
4SUR 080 002 S08	8 X R0.2	19	-	70	8								
4SUR 080 010 S08	8 X R1	19	-	70	8								
4SUR 090 003 S10	9 X R0.3	20	-	70	10								
4SUR 100 003 300	10 X R0.3	15	30	75	10								
4SUR 100 003 S10	10 X R0.3	22	-	75	10								
4SUR 100 010 S10	10 X R1	22	-	75	10								
4SUR 110 003 S12	11 X R0.3	25	-	80	12								
4SUR 120 003 350	12 X R0.3	20	35	80	12								
4SUR 120 003 S12	12 X R0.3	26	-	80	12								
4SUR 120 010 S12	12 X R1	26	-	80	12								
5SUR 140 005 S16	14 X R0.5	28	-	90	16								
5SUR 160 005 100	16 X R0.5	32	-	100	16								
5SUR 160 005 110	16 X R0.5	42	-	110	16								
5SUR 160 015 100	16 X R1.5	32	-	100	16								
5SUR 160 015 110	16 X R1.5	42	-	110	16								
5SUR 200 005 100	20 X R0.5	38	-	100	20								
5SUR 200 005 110	20 X R0.5	45	-	110	20								
5SUR 200 020 100	20 X R2	38	-	100	20								
5SUR 200 020 110	20 X R2	45	-	110	20								

FOR SUS









단위 : mm

Order Number	날경 Diameter D×R	날장 Length of cut L1	유효장 Effective Length L2	전장 Overall Length L	샙크 Shank Dia d	비고	Order Number	날경 Diameter D×R	날장 Length of cut L1	유효장 Effective Length L2	전장 Overall Length L	샙크 Shank Dia d	비고
2COR 030 001 350	3 X R0.1	4	35	75	6		2COR 040 005 160	4 X R0.5	5	16	55	6	
2COR 030 001 400	3 X R0.1	4	40	80	6		2COR 040 005 200	4 X R0.5	5	20	60	6	
2COR 030 002 100	3 X R0.2	4	10	55	6		2COR 040 005 300	4 X R0.5	5	30	70	6	
2COR 030 002 120	3 X R0.2	4	12	55	6		2COR 040 005 400	4 X R0.5	5	40	80	6	
2COR 030 002 160	3 X R0.2	4	16	55	6		2COR 040 010 120	4 X R1	5	12	55	6	
2COR 030 002 200	3 X R0.2	4	20	60	6		2COR 040 010 160	4 X R1	5	16	55	6	
2COR 030 002 250	3 X R0.2	4	25	65	6		2COR 040 010 200	4 X R1	5	20	60	6	
2COR 030 002 300	3 X R0.2	4	30	70	6		2COR 040 010 300	4 X R1	5	30	70	6	
2COR 030 002 350	3 X R0.2	4	35	75	6		2COR 040 010 400	4 X R1	5	40	80	6	
2COR 030 002 400	3 X R0.2	4	40	80	6		2COR 060 001 200	6 X R0.1	7	20	60	6	
2COR 030 003 100	3 X R0.3	4	10	55	6		2COR 060 002 200	6 X R0.2	7	20	60	6	
2COR 030 003 120	3 X R0.3	4	12	55	6		2COR 060 003 200	6 X R0.3	7	20	60	6	
2COR 030 003 160	3 X R0.3	4	16	55	6		2COR 060 005 200	6 X R0.5	7	20	60	6	
2COR 030 003 200	3 X R0.3	4	20	60	6		2COR 060 010 200	6 X R1	7	20	60	6	
2COR 030 003 250	3 X R0.3	4	25	65	6		2COR 060 015 200	6 X R1.5	7	20	60	6	
2COR 030 003 300	3 X R0.3	4	30	70	6		2COR 080 005 250	8 X R0.5	9	25	65	8	
2COR 030 003 350	3 X R0.3	4	35	75	6		2COR 080 010 250	8 X R1	9	25	65	8	
2COR 030 003 400	3 X R0.3	4	40	80	6		2COR 080 015 250	8 X R1.5	9	25	65	8	
2COR 030 005 100	3 X R0.5	4	10	55	6		2COR 100 005 320	10 X R0.5	11	32	70	10	
2COR 030 005 120	3 X R0.5	4	12	55	6		2COR 100 010 320	10 X R1	11	32	70	10	
2COR 030 005 160	3 X R0.5	4	16	55	6		2COR 100 015 320	10 X R1.5	11	32	70	10	
2COR 030 005 200	3 X R0.5	4	20	60	6		2COR 120 005 380	12 X R0.5	12	38	80	12	
2COR 030 005 250	3 X R0.5	4	25	65	6		2COR 120 010 380	12 X R1	12	38	80	12	
2COR 030 005 300	3 X R0.5	4	30	70	6		2COR 120 015 380	12 X R1.5	12	38	80	12	
2COR 030 005 350	3 X R0.5	4	35	75	6								
2COR 030 005 400	3 X R0.5	4	40	80	6								
2COR 030 010 100	3 X R1	4	10	55	6								
2COR 030 010 120	3 X R1	4	12	55	6								
2COR 030 010 160	3 X R1	4	16	55	6								
2COR 030 010 200	3 X R1	4	20	60	6								
2COR 030 010 250	3 X R1	4	25	65	6								
2COR 030 010 300	3 X R1	4	30	70	6								
2COR 030 010 350	3 X R1	4	35	75	6								
2COR 030 010 400	3 X R1	4	40	80	6								
2COR 040 001 120	4 X R0.1	5	12	55	6								
2COR 040 001 160	4 X R0.1	5	16	55	6								
2COR 040 001 200	4 X R0.1	5	20	60	6								
2COR 040 001 300	4 X R0.1	5	30	70	6								
2COR 040 001 400	4 X R0.1	5	40	80	6								
2COR 040 002 120	4 X R0.2	5	12	55	6								
2COR 040 002 160	4 X R0.2	5	16	55	6								
2COR 040 002 200	4 X R0.2	5	20	60	6								
2COR 040 002 300	4 X R0.2	5	30	70	6								
2COR 040 002 400	4 X R0.2	5	40	80	6								
2COR 040 003 120	4 X R0.3	5	12	55	6								
2COR 040 003 160	4 X R0.3	5	16	55	6								
2COR 040 003 200	4 X R0.3	5	20	60	6								
2COR 040 003 300	4 X R0.3	5	30	70	6								
2COR 040 003 400	4 X R0.3	5	40	80	6								
2COR 040 005 120	4 X R0.5	5	12	55	6								

FOR COPPER

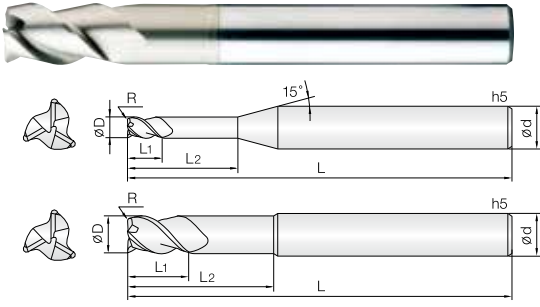

- 동 및 동합금, 알루미늄 합금, 비철합금 가공용 엔드밀
- JCRO 코팅 처리하여 다양한 피삭재 가공시 인선부에 스트레스가 적으며, 피삭재의 면조도가 향상됩니다.
- 3날 45° 헬릭스 형상과 깊은 포켓으로 설계하여 칩배출이 원활하며, 고속, 고이송 작업에 적합합니다.
- 항절력이 높은 미립자 초경합금 (0.5µm)을 채택, 엔드밀의 파손을 최소화.
- Endmills for copper, copper alloys, non-ferrous and non-metallic materials
- JCRO coating provides wear resistance improvement as well as avoid edge stress in various applications.
- High speed, feed applicable by 3 flute 45° degree helix and deep chip pocket design.
- Minimize fracturing by high TRS fine(0.5µm) WC grade.



Condition	D Size	D Tolerance	Condition	D Size	D Tolerance
ØD ≠ Ød	Ø1 ~ 25	+0 ~ -0.01mm	ØD = Ød	Ø3 ~ 12	-0.005 ~ -0.015mm
				Ø12.1 ~ 25	-0.01 ~ -0.02mm

단위 : mm

Order Number	날경 Diameter D × R	날장 Length of cut L1	유효장 Effective Length L2	전장 Overall Length L	샙크 Shank Dia d	비고
3COR 010 001 030	1 X R0.1	1.5	3	45	4	
3COR 010 001 060	1 X R0.1	1.5	6	45	4	
3COR 010 001 100	1 X R0.1	1.5	10	45	4	
3COR 010 002 030	1 X R0.2	1.5	3	45	4	
3COR 010 002 060	1 X R0.2	1.5	6	45	4	
3COR 010 002 100	1 X R0.2	1.5	10	45	4	
3COR 015 001 050	1.5 X R0.1	2	5	45	4	
3COR 015 001 080	1.5 X R0.1	2	8	45	4	
3COR 015 001 120	1.5 X R0.1	2	12	45	4	
3COR 015 002 050	1.5 X R0.2	2	5	45	4	
3COR 015 002 080	1.5 X R0.2	2	8	45	4	
3COR 015 002 120	1.5 X R0.2	2	12	45	4	
3COR 020 001 060	2 X R0.1	3	6	45	4	
3COR 020 001 100	2 X R0.1	3	10	45	4	
3COR 020 001 140	2 X R0.1	3	14	45	4	
3COR 020 002 060	2 X R0.2	3	6	45	4	
3COR 020 002 100	2 X R0.2	3	10	45	4	
3COR 020 002 140	2 X R0.2	3	14	45	4	
3COR 025 001 080	2.5 X R0.1	3.5	8	45	4	
3COR 025 001 120	2.5 X R0.1	3.5	12	45	4	
3COR 025 001 160	2.5 X R0.1	3.5	16	45	4	
3COR 025 002 080	2.5 X R0.2	3.5	8	45	4	
3COR 025 002 120	2.5 X R0.2	3.5	12	45	4	
3COR 025 002 160	2.5 X R0.2	3.5	16	45	4	
3COR 025 005 080	2.5 X R0.5	3.5	8	45	4	
3COR 025 005 120	2.5 X R0.5	3.5	12	45	4	
3COR 025 005 160	2.5 X R0.5	3.5	16	45	4	
3COR 030 002 100	3 X R0.2	4	10	50	4	
New 3COR 030 002 120	3 X R0.2	4	12	50	4	
3COR 030 002 160	3 X R0.2	4	16	50	4	
3COR 030 002 200	3 X R0.2	4	20	50	4	
3COR 030 003 100	3 X R0.3	4	10	50	4	
New 3COR 030 003 120	3 X R0.3	4	12	50	4	
3COR 030 003 160	3 X R0.3	4	16	50	4	
3COR 030 003 200	3 X R0.3	4	20	50	4	
3COR 030 005 100	3 X R0.5	4	10	50	4	
New 3COR 030 005 120	3 X R0.5	4	12	50	4	
3COR 030 005 160	3 X R0.5	4	16	50	4	
3COR 030 005 200	3 X R0.5	4	20	50	4	
3COR 040 002 120	4 X R0.2	6	12	50	4	
3COR 040 002 160	4 X R0.2	6	16	50	4	
3COR 040 002 200	4 X R0.2	6	20	50	4	
3COR 040 003 120	4 X R0.3	6	12	50	4	
3COR 040 003 160	4 X R0.3	6	16	50	4	
3COR 040 003 200	4 X R0.3	6	20	50	4	
3COR 040 005 120	4 X R0.5	6	12	50	4	
3COR 040 005 160	4 X R0.5	6	16	50	4	
3COR 040 005 200	4 X R0.5	6	20	50	4	
3COR 060 003 200	6 X R0.3	9	20	55	6	
3COR 060 003 300	6 X R0.3	9	30	70	6	

Order Number	날경 Diameter D × R	날장 Length of cut L1	유효장 Effective Length L2	전장 Overall Length L	샙크 Shank Dia d	비고
3COR 060 005 200	6 X R0.5	9	20	55	6	
3COR 060 005 300	6 X R0.5	9	30	70	6	
3COR 060 010 200	6 X R1	9	20	55	6	
3COR 060 010 300	6 X R1	9	30	70	6	
3COR 080 003 S08	8 X R0.3	12	25	65	8	
3COR 080 005 S08	8 X R0.5	12	25	65	8	
3COR 080 010 S08	8 X R1	12	25	65	8	
3COR 100 005 S10	10 X R0.5	15	30	70	10	
3COR 100 010 S10	10 X R1	15	30	70	10	
3COR 120 005 S12	12 X R0.5	20	35	80	12	
3COR 120 010 S12	12 X R1	20	35	80	12	





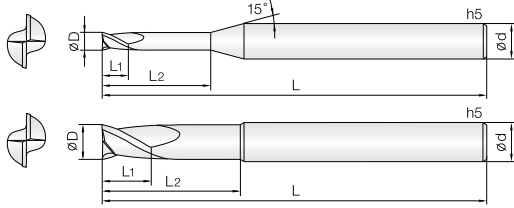

- 알루미늄 및 알루미늄 합금, 동 및 동합금, 강화플라스틱(CFRP), 유리/탄소섬유 등 비철 비금속 계열의 다양한 피삭재 전용 엔드밀
- 코팅피막에 경도가 높고 마찰계수가 낮은 TetraBond TAC코팅을 적용하여 내마모성이 우수하며, 피삭재의 표면조도가 월등히 우수합니다.
- 인선부 강성을 보강하여 날부치핑을 최소화 하였습니다.
- 고정밀 공차 적용으로 초정밀가공에 적합합니다.

- Endmills for Aluminum, Aluminum alloys, copper, copper alloys, CFRP, glass/carbon fiber, non-ferrous and non-metallic materials

- TetraBond TAC coating provides excellent work surface finish by high hardness and low friction.
- Reinforced edge design for preventing edge chipping.
- High precise edge tolerance.

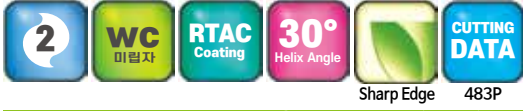

Condition	D Size	D Tolerance	Condition	D Size	D Tolerance
ØD ≠ Ød	Ø0.1 ~ 6	+0 ~ -0.01mm	ØD = Ød	Ø6	-0.005 ~ -0.015mm
	Ø6 ~ 12	+0 ~ -0.015mm		Ø8 ~ 12	-0.01 ~ -0.025mm

단위 : mm

Order Number	날경 Diameter D	날장 Length of cut L1	유효장 Effective Length L2	전장 Overall Length L	생크 Shank Dia d	비고	Order Number	날경 Diameter D	날장 Length of cut L1	유효장 Effective Length L2	전장 Overall Length L	생크 Shank Dia d	비고
2DRE 001 003 S04	0.1	0.3	-	45	4		2DRE 030 120 S06	3	4.5	12	50	6	
2DRE 001 005 S04	0.1	0.5	-	45	4		2DRE 030 160 S06	3	4.5	16	60	6	
New 2DRE 0015 005 S04	0.15	0.5	-	45	4		2DRE 030 200 S06	3	4.5	20	60	6	
New 2DRE 0015 010 S04	0.15	0.3	1	45	4		2DRE 030 250 S06	3	4.5	25	65	6	
2DRE 002 005 S04	0.2	0.5	-	45	4		2DRE 030 300 S06	3	4.5	30	70	6	
2DRE 002 010 S04	0.2	0.3	1	45	4		2DRE 030 400 S06	3	4.5	40	80	6	
2DRE 002 015 S04	0.2	0.3	1.5	45	4		2DRE 040 120 S06	4	6	12	50	6	
2DRE 002 020 S04	0.2	0.3	2	45	4		2DRE 040 160 S06	4	6	16	60	6	
2DRE 003 010 S04	0.3	0.5	1	45	4		2DRE 040 200 S06	4	6	20	60	6	
2DRE 003 015 S04	0.3	0.5	1.5	45	4		2DRE 040 250 S06	4	6	25	65	6	
2DRE 003 020 S04	0.3	0.5	2	45	4		2DRE 040 300 S06	4	6	30	70	6	
2DRE 004 010 S04	0.4	0.6	1	45	4		2DRE 040 400 S06	4	6	40	80	6	
2DRE 004 020 S04	0.4	0.6	2	45	4		2DRE 050 200 S06	5	6	20	60	6	
2DRE 004 030 S04	0.4	0.6	3	45	4		2DRE 050 400 S06	5	6	40	80	6	
2DRE 004 040 S04	0.4	0.6	4	45	4		2DRE 060 200 S06	6	8	20	60	6	
2DRE 004 050 S04	0.4	0.6	5	45	4		2DRE 060 300 S06	6	8	30	90	6	
2DRE 005 020 S04	0.5	0.7	2	45	4		2DRE 080 200 S08	8	12	20	70	8	
2DRE 005 040 S04	0.5	0.7	4	45	4		2DRE 100 250 S10	10	15	25	80	10	
2DRE 005 060 S04	0.5	0.7	6	45	4		2DRE 120 300 S12	12	18	30	80	12	
2DRE 005 080 S04	0.5	0.7	8	45	4								
2DRE 005 100 S04	0.5	0.7	10	45	4								
2DRE 006 020 S04	0.6	0.9	2	45	4								
2DRE 006 040 S04	0.6	0.9	4	45	4								
2DRE 006 060 S04	0.6	0.9	6	45	4								
2DRE 006 080 S04	0.6	0.9	8	45	4								
2DRE 006 100 S04	0.6	0.9	10	45	4								
2DRE 008 020 S04	0.8	1.2	2	45	4								
2DRE 008 040 S04	0.8	1.2	4	45	4								
2DRE 008 060 S04	0.8	1.2	6	45	4								
2DRE 008 080 S04	0.8	1.2	8	45	4								
2DRE 008 100 S04	0.8	1.2	10	45	4								
2DRE 008 120 S04	0.8	1.2	12	45	4								
2DRE 010 040 S04	1	1.5	4	45	4								
2DRE 010 060 S04	1	1.5	6	45	4								
2DRE 010 080 S04	1	1.5	8	45	4								
2DRE 010 100 S04	1	1.5	10	45	4								
2DRE 010 120 S04	1	1.5	12	45	4								
2DRE 010 160 S04	1	1.5	16	50	4								
2DRE 015 060 S04	1.5	2.3	6	45	4								
2DRE 015 080 S04	1.5	2.3	8	45	4								
2DRE 015 100 S04	1.5	2.3	10	45	4								
2DRE 015 120 S04	1.5	2.3	12	45	4								
2DRE 015 160 S04	1.5	2.3	16	50	4								
2DRE 015 200 S04	1.5	2.3	20	50	4								
2DRE 020 060 S04	2	3	6	45	4								
2DRE 020 080 S04	2	3	8	45	4								
2DRE 020 100 S04	2	3	10	45	4								
2DRE 020 120 S04	2	3	12	45	4								
2DRE 020 160 S04	2	3	16	50	4								
2DRE 020 200 S04	2	3	20	50	4								





# 2DLE 2 Flutes R-TAC Coated End Mills for Non-Ferrous Metal

## 2날 비철 가공용 R-TAC코팅 엔드밀

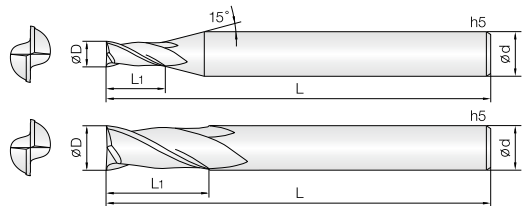

- 알루미늄 및 알루미늄 합금, 동 및 동합금, 강화플라스틱(CFRP), 유리/탄소섬유 등 비철 비금속 계열의 다양한 피삭재 전용 엔드밀
- 코팅 피막에 경도가 높고 마찰계수가 낮은 Tetrabond TAC코팅을 적용하여 내마모성이 우수하며, 피삭재의 표면조도가 월등히 우수합니다.
- 인선부 강성을 보강하여 날부치핑을 최소화 하였습니다.
- 고정밀 공차 적용으로 초정밀가공에 적합합니다.

- Endmills for Aluminum, Aluminum alloys, copper, copper alloys, CFRP, glass/carbon fiber, non-ferrous and non-metallic materials
- Tetrabond TAC coating provides excellent work surface finish by high hardness and low friction.
- Reinforced edge design for preventing edge chipping.
- High precise edge tolerance.

2 미립자
WC
RTAC Coating
30° Helix Angle
Sharp Edge
483P
CUTTING DATA

Condition	D Size	D Tolerance	Condition	D Size	D Tolerance
∅D ≠ ∅d	∅0.4 ~ 6	+0 ~ -0.01mm	∅D = ∅d	∅6	-0.005 ~ -0.015mm
	∅8 ~ 12	+0 ~ -0.015mm		∅8 ~ 12	-0.01 ~ -0.025mm

단위 : mm

Order Number	날경 Diameter D	날장 Length of cut L1	전장 Overall Length L	생크 Shank Dia d	비고	Order Number	날경 Diameter D	날장 Length of cut L1	전장 Overall Length L	생크 Shank Dia d	비고
2DLE 004 008 S04	0.4	0.8	45	4							
2DLE 005 010 S04	0.5	1	45	4							
2DLE 006 012 S04	0.6	1.2	45	4							
2DLE 007 014 S04	0.7	1.4	45	4							
2DLE 008 016 S04	0.8	1.6	45	4							
2DLE 010 025 S04	1	2.5	45	4							
2DLE 010 040 S04	1	4	45	4							
2DLE 012 040 S04	1.2	4	45	4							
2DLE 015 040 S04	1.5	4	45	4							
2DLE 020 060 S04	2	6	45	4							
2DLE 020 080 S04	2	8	45	4							
2DLE 025 080 S04	2.5	8	50	4							
2DLE 030 100 S06	3	10	50	6							
2DLE 030 120 S06	3	12	50	6							
2DLE 035 100 S06	3.5	10	50	6							
2DLE 040 120 S06	4	12	60	6							
2DLE 050 150 S06	5	15	60	6							
2DLE 060 150 S06	6	15	60	6							
2DLE 060 240 S06	6	24	60	6							
2DLE 080 200 S08	8	20	65	8							
2DLE 100 250 S10	10	25	70	10							
2DLE 120 300 S12	12	30	80	12							

R-TAC





2날 비철 가공용 R-TAC코팅 코너 레디우스 엔드밀

단위 : mm

Order Number	날경 Diameter D×R	날장 Length of cut L1	유효장 Effective Length L2	전장 Overall Length L	생크 Shank Dia d	비고	Order Number	날경 Diameter D×R	날장 Length of cut L1	유효장 Effective Length L2	전장 Overall Length L	생크 Shank Dia d	비고
2DLC 030 002 120	3 X R0.2	4.5	12	50	6								
2DLC 030 002 160	3 X R0.2	4.5	16	60	6								
2DLC 030 002 200	3 X R0.2	4.5	20	60	6								
2DLC 030 002 250	3 X R0.2	4.5	25	65	6								
2DLC 030 002 300	3 X R0.2	4.5	30	70	6								
2DLC 030 003 100	3 X R0.3	4.5	10	50	6								
2DLC 030 003 120	3 X R0.3	4.5	12	50	6								
2DLC 030 003 160	3 X R0.3	4.5	16	60	6								
2DLC 030 003 200	3 X R0.3	4.5	20	60	6								
2DLC 030 003 250	3 X R0.3	4.5	25	65	6								
2DLC 030 003 300	3 X R0.3	4.5	30	70	6								
2DLC 030 005 100	3 X R0.5	4.5	10	50	6								
2DLC 030 005 120	3 X R0.5	4.5	12	50	6								
2DLC 030 005 160	3 X R0.5	4.5	16	60	6								
2DLC 030 005 200	3 X R0.5	4.5	20	60	6								
2DLC 030 005 250	3 X R0.5	4.5	25	65	6								
2DLC 030 005 300	3 X R0.5	4.5	30	70	6								
2DLC 040 002 120	4 X R0.2	6	12	50	6								
2DLC 040 002 160	4 X R0.2	6	16	60	6								
2DLC 040 002 200	4 X R0.2	6	20	60	6								
2DLC 040 005 120	4 X R0.5	6	12	50	6								
2DLC 040 005 160	4 X R0.5	6	16	60	6								
2DLC 040 005 200	4 X R0.5	6	20	60	6								
2DLC 040 005 250	4 X R0.5	6	25	65	6								
2DLC 040 005 300	4 X R0.5	6	30	70	6								
2DLC 040 010 120	4 X R1	6	12	50	6								
2DLC 040 010 160	4 X R1	6	16	60	6								
2DLC 040 010 200	4 X R1	6	20	60	6								
2DLC 040 010 250	4 X R1	6	25	65	6								
2DLC 040 010 300	4 X R1	6	30	70	6								
New 2DLC 060 002 200	6 X R0.2	9	20	60	6								
2DLC 060 003 200	6 X R0.3	9	20	60	6								
2DLC 060 005 200	6 X R0.5	9	20	60	6								
2DLC 060 010 200	6 X R1	9	20	60	6								
2DLC 080 003 250	8 X R0.3	12	25	65	8								
2DLC 080 005 250	8 X R0.5	12	25	65	8								
2DLC 080 010 250	8 X R1	12	25	65	8								
2DLC 100 005 300	10 X R0.5	15	30	70	10								
2DLC 100 010 300	10 X R1	15	30	70	10								
2DLC 120 005 320	12 X R0.5	18	32	80	12								
2DLC 120 010 320	12 X R1	18	32	80	12								

R-TAC

### 2날 45° 헬릭스 알루미늄 전용 볼 엔드밀

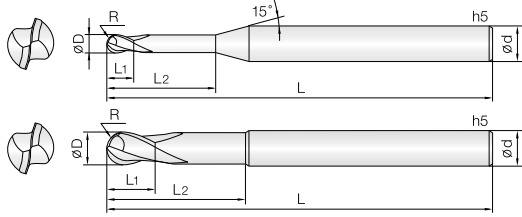

2

WC  
미립자

R  
± 0.005

R  
± 0.01

R  
± 0.015

45°  
Helix Angle

CUTTING  
DATA

0.25 ~ 2.5R    3R ~ 6R    8R    485P

- 알루미늄, 알루미늄 합금, 동 및 동합금 등 비철 비금속 계열 전용 엔드밀
- 날부인선을 고광면 설계하여 절삭시 피삭재의 표면조도가 우수합니다.
- 45° 헬릭스 형상과 깊은 포켓으로 설계하여 칩배출이 우수하며, 고속, 고이송 가공에 적합합니다.
- 항절력이 높은 미립자 초경합금(0.5 $\mu$ m)을 채택, 엔드밀의 파손을 최소화.

- Endmills for Aluminum, AL alloys, copper, copper alloys, non-ferrous and non-metallic materials.
- Applied fine WC grade for excellent surface finish.
- Minimize fracturing by high TRS fine(0.5 $\mu$ m) WC grade.
- High speed, feed applicable by 45° degree helix and deep chip pocket design

D Size	D Tolerance
Ø 0.5 ~ 5	+0 ~ -0.01mm
Ø 6 ~ 12	-0.005 ~ -0.015mm
Ø 16	-0.01 ~ -0.02mm

단위 : mm

Order Number	날경 Diameter D	날장 Length of cut L1	유효장 Effective Length L2	전장 Overall Length L	샙크 Shank Dia d	비고
2ALB 005 010 S04	0.25R X 0.5	0.7	1	45	4	
2ALB 005 020 S04	0.25R X 0.5	0.7	2	45	4	
2ALB 005 030 S04	0.25R X 0.5	0.7	3	45	4	
2ALB 005 040 S04	0.25R X 0.5	0.7	4	45	4	
2ALB 005 050 S04	0.25R X 0.5	0.7	5	45	4	
2ALB 005 060 S04	0.25R X 0.5	0.7	6	45	4	
2ALB 006 020 S04	0.3R X 0.6	0.9	2	45	4	
2ALB 006 030 S04	0.3R X 0.6	0.9	3	45	4	
2ALB 006 040 S04	0.3R X 0.6	0.9	4	45	4	
2ALB 006 050 S04	0.3R X 0.6	0.9	5	45	4	
2ALB 006 060 S04	0.3R X 0.6	0.9	6	45	4	
2ALB 006 080 S04	0.3R X 0.6	0.9	8	45	4	
2ALB 006 100 S04	0.3R X 0.6	0.9	10	45	4	
2ALB 008 020 S04	0.4R X 0.8	1.2	2	45	4	
2ALB 008 030 S04	0.4R X 0.8	1.2	3	45	4	
2ALB 008 040 S04	0.4R X 0.8	1.2	4	45	4	
2ALB 008 060 S04	0.4R X 0.8	1.2	6	45	4	
2ALB 008 080 S04	0.4R X 0.8	1.2	8	45	4	
2ALB 008 100 S04	0.4R X 0.8	1.2	10	45	4	
2ALB 008 120 S04	0.4R X 0.8	1.2	12	45	4	
2ALB 010 030 S04	0.5R X 1	1.5	3	50	4	
2ALB 010 050 S04	0.5R X 1	1.5	5	50	4	
2ALB 010 080 S04	0.5R X 1	1.5	8	50	4	
2ALB 010 100 S04	0.5R X 1	1.5	10	50	4	
2ALB 010 120 S04	0.5R X 1	1.5	12	50	4	
2ALB 010 160 S04	0.5R X 1	1.5	16	50	4	
2ALB 010 200 S04	0.5R X 1	1.5	20	50	4	
2ALB 012 030 S04	0.6R X 1.2	1.8	3	50	4	
2ALB 012 040 S04	0.6R X 1.2	1.8	4	50	4	
2ALB 012 060 S04	0.6R X 1.2	1.8	6	50	4	
2ALB 012 080 S04	0.6R X 1.2	1.8	8	50	4	
2ALB 012 100 S04	0.6R X 1.2	1.8	10	50	4	
2ALB 012 120 S04	0.6R X 1.2	1.8	12	50	4	
2ALB 015 050 S04	0.75R X 1.5	2	5	50	4	
2ALB 015 080 S04	0.75R X 1.5	2	8	50	4	
2ALB 015 100 S04	0.75R X 1.5	2	10	50	4	
2ALB 015 120 S04	0.75R X 1.5	2	12	50	4	
2ALB 015 160 S04	0.75R X 1.5	2	16	50	4	
2ALB 015 200 S04	0.75R X 1.5	2	20	50	4	
2ALB 020 050 S06	1R X 2	3	5	50	6	
2ALB 020 080 S06	1R X 2	3	8	50	6	
2ALB 020 100 S06	1R X 2	3	10	50	6	
2ALB 020 120 S06	1R X 2	3	12	60	6	
2ALB 020 160 S06	1R X 2	3	16	60	6	
2ALB 020 200 S06	1R X 2	3	20	60	6	
2ALB 020 250 S06	1R X 2	3	25	65	6	
2ALB 025 060 S06	1.25R X 2.5	4	6	50	6	
2ALB 025 100 S06	1.25R X 2.5	4	10	50	6	
2ALB 025 120 S06	1.25R X 2.5	4	12	60	6	
2ALB 025 160 S06	1.25R X 2.5	4	16	60	6	

단위 : mm

Order Number	날경 Diameter D	날장 Length of cut L1	유효장 Effective Length L2	전장 Overall Length L	샹크 Shank Dia d	비고
2ALB 025 200 S06	1.25R X 2.5	4	20	60	6	
2ALB 030 080 S06	1.5R X 3	4.5	8	60	6	
2ALB 030 120 S06	1.5R X 3	4.5	12	60	6	
2ALB 030 160 S06	1.5R X 3	4.5	16	60	6	
2ALB 030 200 S06	1.5R X 3	4.5	20	60	6	
2ALB 030 250 S06	1.5R X 3	4.5	25	70	6	
2ALB 030 300 S06	1.5R X 3	4.5	30	70	6	
2ALB 030 400 S06	1.5R X 3	4.5	40	80	6	
2ALB 040 100 S06	2R X 4	6	10	60	6	
2ALB 040 160 S06	2R X 4	6	16	60	6	
2ALB 040 200 S06	2R X 4	6	20	60	6	
2ALB 040 250 S06	2R X 4	6	25	70	6	
2ALB 040 300 S06	2R X 4	6	30	70	6	
2ALB 040 400 S06	2R X 4	6	40	80	6	
2ALB 050 160 S06	2.5R X 5	8	16	80	6	
2ALB 050 200 S06	2.5R X 5	8	20	80	6	
2ALB 050 250 S06	2.5R X 5	8	25	80	6	
2ALB 060 150 S06	3R X 6	9	15	90	6	
2ALB 060 300 S06	3R X 6	9	30	90	6	
2ALB 060 400 S06	3R X 6	9	40	90	6	
2ALB 080 200 S08	4R X 8	12	20	100	8	
2ALB 100 250 S10	5R X 10	15	25	100	10	
2ALB 120 300 S12	6R X 12	18	30	110	12	
2ALB 160 600 S16	8R X 16	30	60	160	16	

FOR ALUMINUM

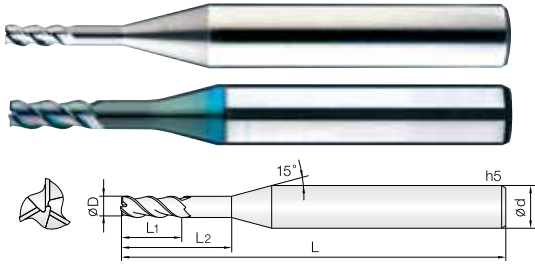

- 알루미늄, 알루미늄 합금 등 비철 비금속 계열 전용 엔드밀
- 날부인선을 고풍면 설계하여 절삭시 피삭재의 표면조도가 우수합니다.
- 다양한 작업에 맞추어 짧은 날장에 유효장을 적용하였습니다.
- 코팅피막에 경도가 높고 마찰계수가 낮은 Tetrabond TAC코팅을 적용하여 내마모성이 우수하며, 피삭재의 표면조도가 월등히 우수합니다.
- 2중 인선과 홈포켓을 깊게 설계하여 칩착현상을 최소화 하였습니다.

#### Endmills for Aluminum, AL alloys, non-ferrous and non-metallic materials.

- Applied fine WC grade for excellent surface finish.
- Applied short flute length for various applications.
- Tetrabond TAC coating provides excellent work surface finish by high hardness and low friction.
- Minimize built up edge by double edge and deep pocket design.

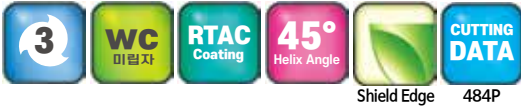

D Size	D Tolerance
Ø0.8 ~ 20	+0 ~ -0.01mm

단위 : mm

Order Number		날경	날장	유효장	전장	샙크	비고	
비코팅 Un coated	RTAC 코팅 RTAC Coated	Diameter D	Length of cut L1	Effective Length L2	Overall Length L	Shank Dia d	비코팅 Un coated	코팅 Coated
3ALR 008 016 S04	3ALRC 008 016 S04	0.8	1.6	-	50	4		
3ALR 008 030 S04	3ALRC 008 030 S04	0.8	1.6	3	50	4		
3ALR 008 040 S04	3ALRC 008 040 S04	0.8	1.6	4	50	4		
3ALR 008 050 S04	3ALRC 008 050 S04	0.8	1.6	5	50	4		
3ALR 008 060 S04	3ALRC 008 060 S04	0.8	1.6	6	50	4		
3ALR 008 080 S04	3ALRC 008 080 S04	0.8	1.6	8	50	4		
3ALR 008 100 S04	3ALRC 008 100 S04	0.8	1.6	10	50	4		
3ALR 008 120 S04	3ALRC 008 120 S04	0.8	1.6	12	50	4		
3ALR 010 020 S06	3ALRC 010 020 S06	1	2	-	60	6		
3ALR 010 040 S06	3ALRC 010 040 S06	1	2	4	60	6		
3ALR 010 060 S06	3ALRC 010 060 S06	1	2	6	60	6		
3ALR 010 080 S06	3ALRC 010 080 S06	1	2	8	60	6		
3ALR 010 100 S06	3ALRC 010 100 S06	1	2	10	60	6		
3ALR 010 120 S06	3ALRC 010 120 S06	1	2	12	60	6		
3ALR 010 140 S06	3ALRC 010 140 S06	1	2	14	60	6		
3ALR 010 160 S06	3ALRC 010 160 S06	1	2	16	60	6		
3ALR 010 180 S06		1	2	18	60	6		
3ALR 010 200 S06		1	2	20	60	6		
3ALR 015 030 S06	3ALRC 015 030 S06	1.5	3	-	60	6		
3ALR 015 060 S06	3ALRC 015 060 S06	1.5	3	6	60	6		
3ALR 015 080 S06	3ALRC 015 080 S06	1.5	3	8	60	6		
3ALR 015 100 S06	3ALRC 015 100 S06	1.5	3	10	60	6		
3ALR 015 120 S06	3ALRC 015 120 S06	1.5	3	12	60	6		
3ALR 015 140 S06	3ALRC 015 140 S06	1.5	3	14	60	6		
3ALR 015 160 S06	3ALRC 015 160 S06	1.5	3	16	60	6		
3ALR 015 180 S06	3ALRC 015 180 S06	1.5	3	18	60	6		
3ALR 015 200 S06	3ALRC 015 200 S06	1.5	3	20	60	6		
3ALR 015 220 S06		1.5	3	22	65	6		
3ALR 015 250 S06		1.5	3	25	65	6		
3ALR 020 040 S06	3ALRC 020 040 S06	2	4	-	60	6		
3ALR 020 080 S06	3ALRC 020 080 S06	2	4	8	60	6		
3ALR 020 100 S06	3ALRC 020 100 S06	2	4	10	60	6		
3ALR 020 120 S06	3ALRC 020 120 S06	2	4	12	60	6		
3ALR 020 140 S06	3ALRC 020 140 S06	2	4	14	60	6		
3ALR 020 160 S06	3ALRC 020 160 S06	2	4	16	60	6		
3ALR 020 200 S06	3ALRC 020 200 S06	2	4	20	60	6		
3ALR 020 220 S06	3ALRC 020 220 S06	2	4	22	60	6		
3ALR 020 250 S06	3ALRC 020 250 S06	2	4	25	65	6		
3ALR 020 280 S06		2	4	28	70	6		
3ALR 020 300 S06		2	4	30	70	6		
3ALR 025 050 S06	3ALRC 025 050 S06	2.5	5	-	60	6		
3ALR 025 100 S06	3ALRC 025 100 S06	2.5	5	10	60	6		
3ALR 025 150 S06	3ALRC 025 150 S06	2.5	5	15	60	6		
3ALR 025 200 S06	3ALRC 025 200 S06	2.5	5	20	60	6		
3ALR 025 250 S06	3ALRC 025 250 S06	2.5	5	25	65	6		
3ALR 025 300 S06	3ALRC 025 300 S06	2.5	5	30	70	6		
3ALR 025 350 S06		2.5	5	35	80	6		
3ALR 025 400 S06		2.5	5	40	90	6		
3ALR 030 060 S06	3ALRC 030 060 S06	3	6	-	60	6		
3ALR 030 100 S06	3ALRC 030 100 S06	3	6	10	60	6		



단위 : mm

Order Number		날경 Diameter D	날장 Length of cut L1	유효장 Effective Length L2	전장 Overall Length L	샙크 Shank Dia d	비고	
비코팅 Un coated	RTAC 코팅 RTAC Coated						비코팅 Un coated	코팅 Coated
3ALR 030 150 S06	3ALRC 030 150 S06	3	6	15	60	6		
3ALR 030 200 S06	3ALRC 030 200 S06	3	6	20	70	6		
3ALR 030 250 S06	3ALRC 030 250 S06	3	6	25	70	6		
3ALR 030 300 S06	3ALRC 030 300 S06	3	6	30	80	6		
3ALR 030 350 S06	3ALRC 030 350 S06	3	6	35	80	6		
3ALR 030 400 S06	3ALRC 030 400 S06	3	6	40	90	6		
3ALR 030 450 S06		3	6	45	90	6		
3ALR 030 500 S06		3	6	50	100	6		
3ALR 040 080 S06	3ALRC 040 080 S06	4	8	-	70	6		
3ALR 040 100 S06	3ALRC 040 100 S06	4	8	10	70	6		
3ALR 040 150 S06	3ALRC 040 150 S06	4	8	15	70	6		
3ALR 040 200 S06	3ALRC 040 200 S06	4	8	20	70	6		
3ALR 040 250 S06	3ALRC 040 250 S06	4	8	25	70	6		
3ALR 040 300 S06	3ALRC 040 300 S06	4	8	30	80	6		
3ALR 040 350 S06	3ALRC 040 350 S06	4	8	35	80	6		
3ALR 040 400 S06	3ALRC 040 400 S06	4	8	40	90	6		
3ALR 040 450 S06		4	8	45	90	6		
3ALR 040 500 S06		4	8	50	100	6		
3ALR 050 100 S06	3ALRC 050 100 S06	5	10	-	80	6		
3ALR 050 200 S06	3ALRC 050 200 S06	5	10	20	80	6		
3ALR 050 300 S06	3ALRC 050 300 S06	5	10	30	80	6		
3ALR 050 400 S06	3ALRC 050 400 S06	5	10	40	90	6		
3ALR 050 500 S06	3ALRC 050 500 S06	5	10	50	100	6		
3ALR 050 600 S06		5	10	60	110	6		
3ALR 060 200 S06	3ALRC 060 200 S06	6	12	20	80	6		
3ALR 060 400 S06	3ALRC 060 400 S06	6	12	40	80	6		
3ALR 060 600 110	3ALRC 060 600 110	6	12	60	110	6		
3ALR 060 800 120		6	12	80	120	6		
3ALR 080 400 S08	3ALRC 080 400 S08	8	16	40	100	8		
3ALR 080 600 110	3ALRC 080 600 110	8	16	60	110	8		
3ALR 080 800 120		8	16	80	120	8		
3ALR 100 500 S10	3ALRC 100 500 S10	10	20	50	110	10		
3ALR 100 700 120	3ALRC 100 700 120	10	20	70	120	10		
3ALR 100 900 150		10	20	90	150	10		
3ALR 120 500 S12	3ALRC 120 500 S12	12	24	50	110	12		
3ALR 120 700 130	3ALRC 120 700 130	12	24	70	130	12		
3ALR 120 900 150		12	24	90	150	12		
3ALR 140 600 110		14	28	60	110	14		
3ALR 140 800 120		14	28	80	120	14		
3ALR 160 800 130		16	32	80	130	16		
3ALR 160 1000 160		16	32	100	160	16		
3ALR 200 800 130		20	40	80	130	20		
3ALR 200 1200 160		20	40	120	160	20		
3ALR 200 1500 200		20	40	150	200	20		

FOR ALUMINUM

### 2날45° 헬릭스 알루미늄 전용 엔드밀

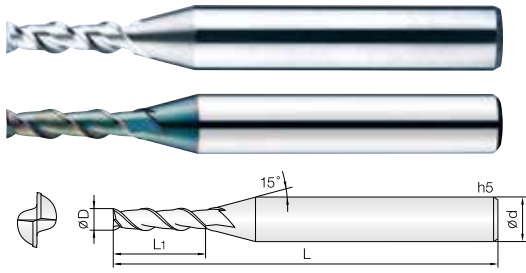

- 알루미늄, 알루미늄 합금 등 비철 비금속 계열 전용 엔드밀
- 날부 인선을 고광면 설계하여 절삭시 피삭재의 표면조도가 우수합니다.
- 다양한 날장(S, L, ExL, Etc) 선택으로 맞춤 가공이 가능합니다.
- 코팅피막에 경도가 높고 마찰계수가 낮은 Tetrabond TAC코팅을 적용하여 내마모성이 우수하며, 피삭재의 표면조도가 월등히 우수합니다.
- 2중 인선과 홈포켓을 깊게 설계하여 흡착현상을 최소화 하였습니다.

#### Endmills for Aluminum, AL alloys, non-ferrous and non-metallic materials

- Applied fine WC grade for excellent surface finish.
- Various flute length design for covering wide range application.
- Tetrabond TAC coating provides excellent work surface finish by high hardness and low friction.
- Minimize built up edge by double edge and deep pocket design.

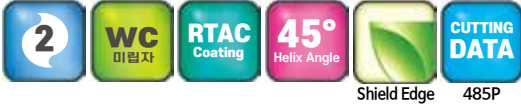

D Size	D Tolerance
Ø 0.5 ~ 20	+0 ~ -0.01mm

단위 : mm

Order Number		날경 Diameter D	날장 Length of cut L1	전장 Overall Length L	샤프크 Shank Dia d	비고	
비코팅 Un coated	RTAC 코팅 RTAC Coated					비코팅 Un coated	코팅 Coated
2ALE 005 005 S04	2ALEC 005 005 S04	0.5	0.5	40	4		
2ALE 005 010 S04	2ALEC 005 010 S04	0.5	1	40	4		
2ALE 005 015 S04	2ALEC 005 015 S04	0.5	1.5	40	4		
2ALE 005 020 S04	2ALEC 005 020 S04	0.5	2	40	4		
2ALE 005 025 S04		0.5	2.5	40	4		
2ALE 005 030 S04		0.5	3	40	4		
2ALE 006 006 S04	2ALEC 006 006 S04	0.6	0.6	40	4		
2ALE 006 012 S04	2ALEC 006 012 S04	0.6	1.2	40	4		
2ALE 006 020 S04	2ALEC 006 020 S04	0.6	2	40	4		
2ALE 006 030 S04		0.6	3	40	4		
2ALE 006 040 S04		0.6	4	40	4		
2ALE 007 007 S04	2ALEC 007 007 S04	0.7	0.7	40	4		
2ALE 007 014 S04	2ALEC 007 014 S04	0.7	1.4	40	4		
2ALE 007 020 S04	2ALEC 007 020 S04	0.7	2	40	4		
2ALE 007 030 S04		0.7	3	40	4		
2ALE 007 040 S04		0.7	4	40	4		
2ALE 008 008 S04	2ALEC 008 008 S04	0.8	0.8	40	4		
2ALE 008 016 S04	2ALEC 008 016 S04	0.8	1.6	40	4		
2ALE 008 020 S04	2ALEC 008 020 S04	0.8	2	40	4		
2ALE 008 030 S04		0.8	3	40	4		
2ALE 008 040 S04		0.8	4	40	4		
2ALE 009 009 S04	2ALEC 009 009 S04	0.9	0.9	40	4		
2ALE 009 018 S04	2ALEC 009 018 S04	0.9	1.8	40	4		
2ALE 009 025 S04	2ALEC 009 025 S04	0.9	2.5	40	4		
2ALE 009 040 S04		0.9	4	40	4		
2ALE 010 015 S04	2ALEC 010 015 S04	1	1.5	40	4		
2ALE 010 015 S06	2ALEC 010 015 S06	1	1.5	40	6		
2ALE 010 025 S04	2ALEC 010 025 S04	1	2.5	40	4		
2ALE 010 025 S06	2ALEC 010 025 S06	1	2.5	40	6		
2ALE 010 035 S04	2ALEC 010 035 S04	1	3.5	40	4		
2ALE 010 035 S06	2ALEC 010 035 S06	1	3.5	40	6		
2ALE 010 050 S06	2ALEC 010 050 S06	1	5	45	6		
2ALE 010 060 S06	2ALEC 010 060 S06	1	6	45	6		
2ALE 010 080 S06	2ALEC 010 080 S06	1	8	45	6		
2ALE 010 100 S06	2ALEC 010 100 S06	1	10	45	6		
2ALE 010 120 S06		1	12	45	6		
2ALE 012 030 S06	2ALEC 012 030 S06	1.2	3	40	6		
2ALE 012 040 S06	2ALEC 012 040 S06	1.2	4	40	6		
2ALE 012 060 S06	2ALEC 012 060 S06	1.2	6	40	6		
2ALE 012 080 S06		1.2	8	45	6		
2ALE 012 100 S06		1.2	10	45	6		
2ALE 015 040 S06	2ALEC 015 040 S06	1.5	4	40	6		
2ALE 015 060 S06	2ALEC 015 060 S06	1.5	6	40	6		
2ALE 015 080 S06	2ALEC 015 080 S06	1.5	8	45	6		
2ALE 015 100 S06	2ALEC 015 100 S06	1.5	10	50	6		
2ALE 015 120 S06	2ALEC 015 120 S06	1.5	12	50	6		
2ALE 015 150 S06	2ALEC 015 150 S06	1.5	15	55	6		
2ALE 015 180 S06		1.5	18	60	6		
2ALE 020 050 S06	2ALEC 020 050 S06	2	5	45	6		
2ALE 020 070 S06	2ALEC 020 070 S06	2	7	45	6		



단위 : mm

Order Number		날경	날장	전장	샙크	비고	
비코팅 Un coated	RTAC 코팅 RTAC Coated	Diameter D	Length of cut L1	Overall Length L	Shank Dia d	비코팅 Un coated	코팅 Coated
2ALE 020 100 S06	2ALEC 020 100 S06	2	10	50	6		
2ALE 020 120 S06	2ALEC 020 120 S06	2	12	50	6		
2ALE 020 140 S06	2ALEC 020 140 S06	2	14	50	6		
2ALE 020 160 S06	2ALEC 020 160 S06	2	16	60	6		
2ALE 020 180 S06		2	18	60	6		
2ALE 020 200 S06		2	20	60	6		
2ALE 025 080 S06	2ALEC 025 080 S06	2.5	8	45	6		
2ALE 025 120 S06	2ALEC 025 120 S06	2.5	12	50	6		
2ALE 025 150 S06	2ALEC 025 150 S06	2.5	15	60	6		
2ALE 025 180 S06		2.5	18	60	6		
2ALE 025 200 S06		2.5	20	60	6		
2ALE 030 080 S06	2ALEC 030 080 S06	3	8	45	6		
2ALE 030 100 S06	2ALEC 030 100 S06	3	10	45	6		
2ALE 030 120 S06	2ALEC 030 120 S06	3	12	50	6		
2ALE 030 150 S06	2ALEC 030 150 S06	3	15	50	6		
2ALE 030 200 S06	2ALEC 030 200 S06	3	20	60	6		
2ALE 030 250 S06	2ALEC 030 250 S06	3	25	65	6		
2ALE 030 300 S06		3	30	70	6		
2ALE 035 100 S06	2ALEC 035 100 S06	3.5	10	45	6		
2ALE 035 150 S06	2ALEC 035 150 S06	3.5	15	50	6		
2ALE 035 200 S06		3.5	20	60	6		
2ALE 040 120 S06	2ALEC 040 120 S06	4	12	50	6		
2ALE 040 150 S06	2ALEC 040 150 S06	4	15	55	6		
2ALE 040 180 S06	2ALEC 040 180 S06	4	18	55	6		
2ALE 040 250 S06	2ALEC 040 250 S06	4	25	65	6		
2ALE 040 300 S06	2ALEC 040 300 S06	4	30	70	6		
2ALE 040 350 S06		4	35	75	6		
2ALE 040 400 S06		4	40	80	6		
2ALE 045 120 S06	2ALEC 045 120 S06	4.5	12	50	6		
2ALE 045 180 S06	2ALEC 045 180 S06	4.5	18	55	6		
2ALE 045 220 S06		4.5	22	65	6		
2ALE 045 250 S06		4.5	25	70	6		
2ALE 050 150 S06	2ALEC 050 150 S06	5	15	50	6		
2ALE 050 200 S06	2ALEC 050 200 S06	5	20	60	6		
2ALE 050 250 S06	2ALEC 050 250 S06	5	25	65	6		
2ALE 050 300 S06	2ALEC 050 300 S06	5	30	70	6		
2ALE 050 400 S06		5	40	80	6		
2ALE 055 150 S06	2ALEC 055 150 S06	5.5	15	50	6		
2ALE 060 150 S06	2ALEC 060 150 S06	6	15	50	6		
2ALE 060 200 S06	2ALEC 060 200 S06	6	20	60	6		
2ALE 060 250 S06	2ALEC 060 250 S06	6	25	65	6		
2ALE 060 300 S06	2ALEC 060 300 S06	6	30	70	6		
2ALE 060 350 S06	2ALEC 060 350 S06	6	35	75	6		
2ALE 060 400 S06	2ALEC 060 400 S06	6	40	80	6		
2ALE 060 450 S06		6	45	90	6		
2ALE 060 500 S06		6	50	100	6		
2ALE 070 200 S08	2ALEC 070 200 S08	7	20	60	8		
2ALE 070 300 S08	2ALEC 070 300 S08	7	30	70	8		
2ALE 080 200 S08	2ALEC 080 200 S08	8	20	60	8		
2ALE 080 250 S08	2ALEC 080 250 S08	8	25	65	8		

단위 : mm

Order Number		날경 Diameter D	날장 Length of cut L1	전장 Overall Length L	샙크 Shank Dia d	비고	
비코팅 Un coated	RTAC 코팅 RTAC Coated					비코팅 Un coated	코팅 Coated
2ALE 080 300 S08	2ALEC 080 300 S08	8	30	70	8		
2ALE 080 400 S08	2ALEC 080 400 S08	8	40	80	8		
2ALE 080 450 S08	2ALEC 080 450 S08	8	45	90	8		
2ALE 080 500 S08		8	50	100	8		
2ALE 100 250 S10	2ALEC 100 250 S10	10	25	70	10		
2ALE 100 300 S10	2ALEC 100 300 S10	10	30	75	10		
2ALE 100 350 S10	2ALEC 100 350 S10	10	35	80	10		
2ALE 100 450 S10	2ALEC 100 450 S10	10	45	90	10		
2ALE 100 500 S10	2ALEC 100 500 S10	10	50	100	10		
2ALE 100 600 S10		10	60	110	10		
2ALE 120 300 S12	2ALEC 120 300 S12	12	30	75	12		
2ALE 120 350 S12	2ALEC 120 350 S12	12	35	80	12		
2ALE 120 400 S12	2ALEC 120 400 S12	12	40	90	12		
2ALE 120 450 S12	2ALEC 120 450 S12	12	45	100	12		
2ALE 120 500 S12	2ALEC 120 500 S12	12	50	100	12		
2ALE 120 600 S12	2ALEC 120 600 S12	12	60	110	12		
2ALE 120 700 S12		12	70	120	12		
2ALE 140 300 S14	2ALEC 140 300 S14	14	30	80	14		
2ALE 140 500 S14		14	50	90	14		
2ALE 140 600 S14		14	60	110	14		
2ALE 160 400 S16	2ALEC 160 400 S16	16	40	90	16		
2ALE 160 550 S16	2ALEC 160 550 S16	16	55	110	16		
2ALE 160 700 S16	2ALEC 160 700 S16	16	70	120	16		
2ALE 160 900 S16		16	90	150	16		
2ALE 200 450 S20	2ALEC 200 450 S20	20	45	100	20		
2ALE 200 650 S20	2ALEC 200 650 S20	20	65	120	20		
2ALE 200 800 S20	2ALEC 200 800 S20	20	80	135	20		
2ALE 200 1000 S20		20	100	160	20		



### 3날 알루미늄 전용 고광택 정삭 엔드밀

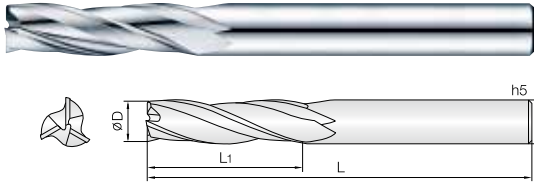

- 알루미늄, 알루미늄 합금 등 비철 비금속 계열 전용 엔드밀
- 25도 헬릭스 설계된 날부 인선을 고광택 설계와 후공정 처리하여 밀링 가공시 피삭재의 월등한 경면 사상을 가능하게 합니다.
- 항절력이 높은 미립자 초경합금 (0.5µm)을 채택, 엔드밀의 파손을 최소화 하였습니다.
- Endmills for Aluminum, AL alloys, non-ferrous and non-metallic materials.
- By 25-degree helix flute edge design with the after-treatment process, when milling workpiece, it enables superior mirror surface milling.
- Minimize fracturing by high TRS fine(0.5µm) WC grade.

D Size	D Tolerance
Ø 6 ~ 16	+0 ~ -0.01mm

단위 : mm

Order Number	날경 Diameter D	날장 Length of cut L1	전장 Overall Length L	샙크 Shank Dia d	비고
New 3FALE 040 130 S04	4	13	55	4	
New 3FALE 040 180 S04	4	18	60	4	
3FALE 060 170 S06	6	17	60	6	
3FALE 060 220 S06	6	22	65	6	
3FALE 080 260 S08	8	26	70	8	
3FALE 080 360 S08	8	36	80	8	
3FALE 100 310 S10	10	31	90	10	
3FALE 100 410 S10	10	41	90	10	
3FALE 120 360 S12	12	36	90	12	
3FALE 120 460 S12	12	46	100	12	
3FALE 160 460 S16	16	46	100	16	
3FALE 160 660 S16	16	66	120	16	

FOR ALUMINUM

### 3날 45° 헬릭스 알루미늄 전용 엔드밀

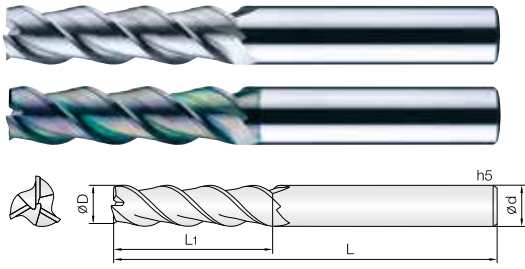

- 알루미늄, 알루미늄 합금 등 비철 비금속 계열 전용 엔드밀
- 날부 인선을 고풍면 설계하여 절삭시 피삭재의 표면조도가 우수합니다.
- 다양한 날장(S, L, ExL, Etc) 선택으로 맞춤 가공이 가능합니다.
- 코팅 피막에 경도가 높고 마찰계수가 낮은 Tetrabond TAC코팅을 적용하여 내마모성이 우수하며, 피삭재의 표면조도가 월등히 우수합니다.
- 2중 인선과 홈포켓을 깊게 설계하여 흡착현상을 최소화 하였습니다.
- Endmills for Aluminum, AL alloys, non-ferrous and non-metallic materials
- Applied fine WC grade for excellent surface finish.
- Various flute length design for covering wide range application.
- Tetrabond TAC coating provides excellent work surface finish by high hardness and low friction.
- Minimize built up edge by double edge and deep pocket design.

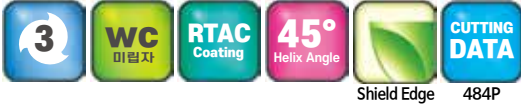

D Size	D Tolerance
ø0.8 ~ 20	+0 ~ -0.01mm

단위 : mm

Order Number	날경 Diameter D	날장 Length of cut L1	전장 Overall Length L	샙크 Shank Dia d	비고	
					비코팅 Un coated	코팅 Coated
3ALE 008 012 S04	0.8	1.2	40	4		
3ALE 008 020 S04	0.8	2	40	4		
3ALE 008 030 S04	0.8	3	40	4		
3ALE 008 040 S04	0.8	4	40	4		
3ALE 010 015 S06	1	1.5	40	6		
3ALE 010 030 S06	1	3	40	6		
3ALE 010 050 S06	1	5	45	6		
3ALE 010 060 S06	1	6	45	6		
3ALE 010 080 S06	1	8	45	6		
3ALE 010 100 S06	1	10	45	6		
3ALE 010 120 S06	1	12	50	6		
3ALE 010 140 S06	1	14	50	6		
3ALE 012 030 S06	1.2	3	40	6		
3ALE 012 040 S06	1.2	4	40	6		
3ALE 012 060 S06	1.2	6	45	6		
3ALE 012 080 S06	1.2	8	45	6		
3ALE 012 100 S06	1.2	10	45	6		
3ALE 012 120 S06	1.2	12	50	6		
3ALE 015 025 S06	1.5	2.5	40	6		
3ALE 015 040 S06	1.5	4	40	6		
3ALE 015 060 S06	1.5	6	45	6		
3ALE 015 080 S06	1.5	8	45	6		
3ALE 015 100 S06	1.5	10	50	6		
3ALE 015 120 S06	1.5	12	50	6		
3ALE 015 150 S06	1.5	15	50	6		
3ALE 015 180 S06	1.5	18	60	6		
3ALE 015 200 S06	1.5	20	60	6		
3ALE 020 030 S06	2	3	45	6		
3ALE 020 050 S06	2	5	45	6		
3ALE 020 070 S06	2	7	45	6		
3ALE 020 100 S06	2	10	50	6		
3ALE 020 120 S06	2	12	50	6		
3ALE 020 140 S06	2	14	60	6		
3ALE 020 160 S06	2	16	60	6		
3ALE 020 180 S06	2	18	60	6		
3ALE 020 200 S06	2	20	60	6		
3ALE 020 220 S06	2	22	60	6		
3ALE 020 250 S06	2	25	65	6		
3ALE 025 040 S06	2.5	4	45	6		
3ALE 025 080 S06	2.5	8	45	6		
3ALE 025 120 S06	2.5	12	50	6		
3ALE 025 150 S06	2.5	15	60	6		
3ALE 025 200 S06	2.5	20	60	6		
3ALE 025 250 S06	2.5	25	65	6		
3ALE 030 045 S06	3	4.5	45	6		
3ALE 030 080 S06	3	8	45	6		
3ALE 030 120 S06	3	12	50	6		
3ALE 030 150 S06	3	15	50	6		
3ALE 030 200 S06	3	20	55	6		
3ALE 030 250 S06	3	25	60	6		

FOR ALUMINUM

단위 : mm

Order Number		날경 Diameter D	날장 Length of cut L1	전장 Overall Length L	샹크 Shank Dia d	비고	
비코팅 Un coated	RTAC 코팅 RTAC Coated					비코팅 Un coated	코팅 Coated
3ALE 030 300 S06	3ALEC 030 300 S06	3	30	65	6		
3ALE 030 350 S06		3	35	75	6		
3ALE 030 400 S06		3	40	80	6		
3ALE 035 055 S06	3ALEC 035 055 S06	3.5	5.5	45	6		
3ALE 035 100 S06	3ALEC 035 100 S06	3.5	10	45	6		
3ALE 035 150 S06	3ALEC 035 150 S06	3.5	15	50	6		
3ALE 035 200 S06	3ALEC 035 200 S06	3.5	20	55	6		
3ALE 035 250 S06	3ALEC 035 250 S06	3.5	25	60	6		
3ALE 035 300 S06	3ALEC 035 300 S06	3.5	30	65	6		
3ALE 035 350 S06		3.5	35	75	6		
3ALE 040 060 S06	3ALEC 040 060 S06	4	6	45	6		
3ALE 040 110 S06	3ALEC 040 110 S06	4	11	45	6		
3ALE 040 160 S06	3ALEC 040 160 S06	4	16	50	6		
3ALE 040 200 S06	3ALEC 040 200 S06	4	20	55	6		
3ALE 040 250 S06	3ALEC 040 250 S06	4	25	60	6		
3ALE 040 300 S06	3ALEC 040 300 S06	4	30	65	6		
3ALE 040 350 S06		4	35	75	6		
3ALE 040 400 S06		4	40	80	6		
3ALE 045 120 S06	3ALEC 045 120 S06	4.5	12	50	6		
3ALE 045 180 S06	3ALEC 045 180 S06	4.5	18	55	6		
3ALE 045 250 S06	3ALEC 045 250 S06	4.5	25	60	6		
3ALE 045 300 S06	3ALEC 045 300 S06	4.5	30	65	6		
3ALE 050 075 S06	3ALEC 050 075 S06	5	7.5	50	6		
3ALE 050 130 S06	3ALEC 050 130 S06	5	13	50	6		
3ALE 050 200 S06	3ALEC 050 200 S06	5	20	55	6		
3ALE 050 250 S06	3ALEC 050 250 S06	5	25	60	6		
3ALE 050 300 S06	3ALEC 050 300 S06	5	30	65	6		
3ALE 050 350 S06	3ALEC 050 350 S06	5	35	70	6		
3ALE 050 400 S06	3ALEC 050 400 S06	5	40	75	6		
3ALE 050 450 S06		5	45	80	6		
3ALE 055 150 S06	3ALEC 055 150 S06	5.5	15	50	6		
3ALE 055 200 S06	3ALEC 055 200 S06	5.5	20	55	6		
3ALE 055 250 S06	3ALEC 055 250 S06	5.5	25	60	6		
3ALE 060 090 050	3ALEC 060 090 050	6	9	50	6		
3ALE 060 150 050	3ALEC 060 150 050	6	15	50	6		
3ALE 060 200 055	3ALEC 060 200 055	6	20	55	6		
3ALE 060 250 060	3ALEC 060 250 060	6	25	60	6		
3ALE 060 300 070	3ALEC 060 300 070	6	30	70	6		
3ALE 060 350 070	3ALEC 060 350 070	6	35	70	6		
3ALE 060 400 075	3ALEC 060 400 075	6	40	75	6		
3ALE 060 450 080	3ALEC 060 450 080	6	45	80	6		
3ALE 060 500 090	3ALEC 060 500 090	6	50	90	6		
3ALE 070 200 060	3ALEC 070 200 060	7	20	60	8		
3ALE 070 300 075	3ALEC 070 300 075	7	30	75	8		
3ALE 070 400 090	3ALEC 070 400 090	7	40	90	8		
3ALE 080 120 060	3ALEC 080 120 060	8	12	60	8		
3ALE 080 200 060	3ALEC 080 200 060	8	20	60	8		
3ALE 080 250 065	3ALEC 080 250 065	8	25	65	8		
3ALE 080 300 070	3ALEC 080 300 070	8	30	70	8		
3ALE 080 350 075	3ALEC 080 350 075	8	35	75	8		



단위 : mm

Order Number		날경 Diameter D	날장 Length of cut L1	전장 Overall Length L	셱크 Shank Dia d	비고	
비코팅 Un coated	RTAC 코팅 RTAC Coated					비코팅 Un coated	코팅 Coated
3ALE 080 400 080	3ALEC 080 400 080	8	40	80	8		
3ALE 080 450 090	3ALEC 080 450 090	8	45	90	8		
3ALE 080 500 090	3ALEC 080 500 090	8	50	90	8		
3ALE 080 550 100	3ALEC 080 550 100	8	55	100	8		
3ALE 080 600 110	3ALEC 080 600 110	8	60	110	8		
3ALE 080 700 120	3ALEC 080 700 120	8	70	120	8		
3ALE 100 150 070	3ALEC 100 150 070	10	15	70	10		
3ALE 100 250 070	3ALEC 100 250 070	10	25	70	10		
3ALE 100 300 075	3ALEC 100 300 075	10	30	75	10		
3ALE 100 350 080	3ALEC 100 350 080	10	35	80	10		
3ALE 100 400 090	3ALEC 100 400 090	10	40	90	10		
3ALE 100 450 090	3ALEC 100 450 090	10	45	90	10		
3ALE 100 500 100	3ALEC 100 500 100	10	50	100	10		
3ALE 100 550 100	3ALEC 100 550 100	10	55	100	10		
3ALE 100 600 110	3ALEC 100 600 110	10	60	110	10		
3ALE 100 650 110	3ALEC 100 650 110	10	65	110	10		
3ALE 100 700 120	3ALEC 100 700 120	10	70	120	10		
3ALE 100 800 130	3ALEC 100 800 130	10	80	130	10		
3ALE 120 180 075	3ALEC 120 180 075	12	18	75	12		
3ALE 120 260 075	3ALEC 120 260 075	12	26	75	12		
3ALE 120 350 080	3ALEC 120 350 080	12	35	80	12		
3ALE 120 400 090	3ALEC 120 400 090	12	40	90	12		
3ALE 120 450 090	3ALEC 120 450 090	12	45	90	12		
3ALE 120 500 100	3ALEC 120 500 100	12	50	100	12		
3ALE 120 550 100	3ALEC 120 550 100	12	55	100	12		
3ALE 120 650 110	3ALEC 120 650 110	12	65	110	12		
3ALE 120 700 120	3ALEC 120 700 120	12	70	120	12		
3ALE 120 800 130	3ALEC 120 800 130	12	80	130	12		
3ALE 140 300 080	3ALEC 140 300 080	14	30	80	14		
3ALE 140 450 110	3ALEC 140 450 110	14	45	110	14		
3ALE 140 600 120		14	60	120	14		
3ALE 160 300 090	3ALEC 160 300 090	16	30	90	16		
3ALE 160 500 110	3ALEC 160 500 110	16	50	110	16		
3ALE 160 650 120	3ALEC 160 650 120	16	65	120	16		
3ALE 160 800 130	3ALEC 160 800 130	16	80	130	16		
3ALE 160 1000 160	3ALEC 160 1000 160	16	100	160	16		
3ALE 200 500 100	3ALEC 200 500 100	20	50	100	20		
3ALE 200 750 130	3ALEC 200 750 130	20	75	130	20		
3ALE 200 1000 160	3ALEC 200 1000 160	20	100	160	20		
3ALE 200 1300 200	3ALEC 200 1300 200	20	130	200	20		
3ALE 200 1500 220	3ALEC 200 1500 220	20	150	220	20		

FOR ALUMINUM

### 4날 알루미늄 고이송 전용 엔드밀

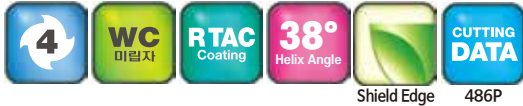
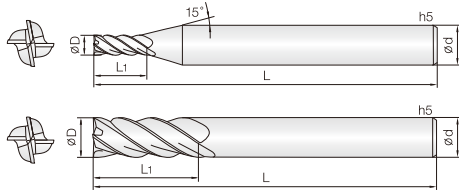

Shield Edge 486P

- 알루미늄, 알루미늄 합금 등 비철 비금속 계열 전용 엔드밀
- 강력한 채터링 방지 설계로 측벽 가공 시 엔드밀의 진동을 최소화하였습니다.
- 2중 인선을 적용하여 중, 황삭 가공 시 뛰어난 성능을 발휘합니다.
- 코팅 피막에 경도가 높고 마찰계수가 낮은 Tetrabond TAC코팅을 적용하여 내마모성이 우수하며, 피삭재의 표면조도가 월등히 우수합니다.
- 홈포켓을 깊게 설계하여 흡착현상을 최소화 하였습니다.

#### Endmills for Aluminum, AL alloys, non-ferrous and non-metallic materials

- The powerful anti-chattering design minimizes the vibration of the endmill during side milling.
- Excellent performance in semi-finishing and roughing by applying a double cutting edge.
- the poket is deeply designed to adsorption.

Condition	D Size	D Tolerance	Condition	D Size	D Tolerance
øD ≠ ød	ø3 ~ 6	+0 ~ -0.01mm	øD = ød	ø6	-0.005 ~ -0.015mm
	ø8 ~ 20	+0 ~ -0.015mm		ø8 ~ 12	-0.01 ~ -0.025mm
		ø16 ~ 20		-0.015 ~ -0.03mm	

단위 : mm

Order Number		날경	날장	전장	생크	비고	
비코팅 Un coated	RTAC 코팅 RTAC Coated	Diameter D	Length of cut L1	Overall Length L	Shank Dia d	비코팅 Un coated	코팅 Coated
4ALE 030 120 S06	4ALEC 030 120 S06	3	12	50	6		
4ALE 030 150 S06	4ALEC 030 150 S06	3	15	50	6		
4ALE 030 150 070	4ALEC 030 150 070	3	15	70	6		
4ALE 030 200 S06	4ALEC 030 200 S06	3	20	55	6		
4ALE 040 110 S06	4ALEC 040 110 S06	4	11	50	6		
4ALE 040 160 S06	4ALEC 040 160 S06	4	16	50	6		
4ALE 040 160 070	4ALEC 040 160 070	4	16	70	6		
4ALE 040 200 S06	4ALEC 040 200 S06	4	20	55	6		
4ALE 050 130 S06	4ALEC 050 130 S06	5	13	50	6		
4ALE 050 200 S06	4ALEC 050 200 S06	5	20	55	6		
4ALE 050 200 080	4ALEC 050 200 080	5	20	80	6		
4ALE 050 250 S06	4ALEC 050 250 S06	5	25	60	6		
4ALE 060 150 S06	4ALEC 060 150 S06	6	15	50	6		
4ALE 060 200 S06	4ALEC 060 200 S06	6	20	55	6		
4ALE 060 200 080	4ALEC 060 200 080	6	20	80	6		
4ALE 060 250 S06	4ALEC 060 250 S06	6	25	60	6		
4ALE 060 300 S06	4ALEC 060 300 S06	6	30	70	6		
4ALE 080 200 S08	4ALEC 080 200 S08	8	20	60	8		
4ALE 080 250 S08	4ALEC 080 250 S08	8	25	65	8		
4ALE 080 250 090	4ALEC 080 250 090	8	25	90	8		
4ALE 080 300 S08	4ALEC 080 300 S08	8	30	70	8		
4ALE 080 350 S08	4ALEC 080 350 S08	8	35	75	8		
4ALE 100 250 S10	4ALEC 100 250 S10	10	25	70	10		
4ALE 100 300 S10	4ALEC 100 300 S10	10	30	75	10		
4ALE 100 300 100	4ALEC 100 300 100	10	30	100	10		
4ALE 100 350 S10	4ALEC 100 350 S10	10	35	80	10		
4ALE 100 400 S10	4ALEC 100 400 S10	10	40	90	10		
4ALE 120 260 S12	4ALEC 120 260 S12	12	26	75	12		
4ALE 120 350 S12	4ALEC 120 350 S12	12	35	80	12		
4ALE 120 350 110	4ALEC 120 350 110	12	35	110	12		
4ALE 120 400 S12	4ALEC 120 400 S12	12	40	90	12		
4ALE 120 450 S12	4ALEC 120 450 S12	12	45	90	12		
4ALE 160 300 S16	4ALEC 160 300 S16	16	30	90	16		
4ALE 160 500 S16	4ALEC 160 500 S16	16	50	110	16		
4ALE 160 500 150	4ALEC 160 500 150	16	50	150	16		
4ALE 160 650 S16	4ALEC 160 650 S16	16	65	120	16		
4ALE 160 800 S16	4ALEC 160 800 S16	16	80	130	16		
4ALE 200 500 S20	4ALEC 200 500 S20	20	50	110	20		
4ALE 200 750 S20	4ALEC 200 750 S20	20	75	130	20		
4ALE 200 750 160	4ALEC 200 750 160	20	75	160	20		
4ALE 200 1000 S20	4ALEC 200 1000 S20	20	100	160	20		

### 3날 45° 헬릭스 알루미늄 전용 코너 레디우스 엔드밀

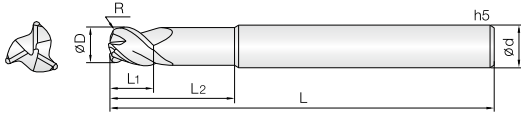

- 알루미늄, 알루미늄 합금 등 비철 비금속 계열 전용 엔드밀
- 날부 인선을 고광면 설계하여 절삭시 피삭재의 표면조도가 우수합니다.
- 2중 인선과 홈포켓을 깊게 설계하여 흠착현상을 최소화 하였습니다.
- 코팅피막에 경도가 높고 마찰계수가 낮은 Tetrabond TAC코팅을 적용하여 내마모성이 우수하며, 피삭재의 표면조도가 월등히 우수합니다.
- 3날45°헬릭스의 짧은 날장으로 설계, 고속 고이송 작업에 적합합니다.

#### Endmills for Aluminum, AL alloys, non-ferrous and non-metallic materials

- Applied fine WC grade for excellent surface finish.
- Minimize built up edge by double edge and deep pocket design.
- Tetrabond TAC coating provides excellent work surface finish by high hardness and low friction.
- High speed, feed applicable by 3 flute 45° degree helix and short flute design.

3

WC  
미립자

RTAC  
Coating

R  
± 0.005

R  
± 0.01

R  
± 0.015

45°  
Helix Angle

CUTTING  
DATA

R0.5    R1 ~ 1.5    R2 ~ 5    487P

D Size	D Tolerance
Ø 3 ~ 20	+0 ~ -0.015mm

단위 : mm

Order Number		날경	날장	유효장	전장	샤프크	비고	
비코팅 Un coated	RTAC 코팅 RTAC Coated	Diameter D × R	Length of cut L1	Effective Length L2	Overall Length L	Shank Dia d	비코팅 Un coated	코팅 Coated
3ALC 030 005 050	3ALCC 030 005 050	3 X R0.5	10	-	50	6		
3ALC 030 005 060	3ALCC 030 005 060	3 X R0.5	10	15	60	6		
3ALC 030 010 050	3ALCC 030 010 050	3 X R1	10	-	50	6		
3ALC 030 010 060	3ALCC 030 010 060	3 X R1	10	15	60	6		
3ALC 040 005 050	3ALCC 040 005 050	4 X R0.5	12	-	50	6		
3ALC 040 005 060	3ALCC 040 005 060	4 X R0.5	12	20	60	6		
3ALC 040 010 050	3ALCC 040 010 050	4 X R1	12	-	50	6		
3ALC 040 010 060	3ALCC 040 010 060	4 X R1	12	20	60	6		
3ALC 050 005 050	3ALCC 050 005 050	5 X R0.5	15	-	50	6		
3ALC 050 005 060	3ALCC 050 005 060	5 X R0.5	15	20	60	6		
3ALC 050 010 050	3ALCC 050 010 050	5 X R1	15	-	50	6		
3ALC 050 010 060	3ALCC 050 010 060	5 X R1	15	20	60	6		
3ALC 060 005 050	3ALCC 060 005 050	6 X R0.5	15	-	50	6		
3ALC 060 005 070	3ALCC 060 005 070	6 X R0.5	7	20	70	6		
3ALC 060 010 050	3ALCC 060 010 050	6 X R1	15	-	50	6		
3ALC 060 010 070	3ALCC 060 010 070	6 X R1	7	20	70	6		
3ALC 080 005 060	3ALCC 080 005 060	8 X R0.5	20	-	60	8		
3ALC 080 005 080	3ALCC 080 005 080	8 X R0.5	9	25	80	8		
3ALC 080 010 060	3ALCC 080 010 060	8 X R1	20	-	60	8		
3ALC 080 010 080	3ALCC 080 010 080	8 X R1	9	25	80	8		
3ALC 080 020 060	3ALCC 080 020 060	8 X R2	20	-	60	8		
3ALC 080 020 080	3ALCC 080 020 080	8 X R2	9	25	80	8		
3ALC 080 025 080	3ALCC 080 025 080	8 X R2.5	9	25	80	8		
3ALC 100 005 070	3ALCC 100 005 070	10 X R0.5	25	-	70	10		
3ALC 100 005 100	3ALCC 100 005 100	10 X R0.5	11	30	100	10		
3ALC 100 010 070	3ALCC 100 010 070	10 X R1	25	-	70	10		
3ALC 100 010 100	3ALCC 100 010 100	10 X R1	11	30	100	10		
3ALC 100 015 070	3ALCC 100 015 070	10 X R1.5	25	-	70	10		
3ALC 100 015 100	3ALCC 100 015 100	10 X R1.5	11	30	100	10		
3ALC 100 020 070	3ALCC 100 020 070	10 X R2	25	-	70	10		
3ALC 100 020 100	3ALCC 100 020 100	10 X R2	11	30	100	10		
3ALC 100 025 100	3ALCC 100 025 100	10 X R2.5	11	30	100	10		
3ALC 120 005 075	3ALCC 120 005 075	12 X R0.5	30	-	75	12		
3ALC 120 005 110	3ALCC 120 005 110	12 X R0.5	13	36	110	12		
3ALC 120 010 075	3ALCC 120 010 075	12 X R1	30	-	75	12		
3ALC 120 010 110	3ALCC 120 010 110	12 X R1	13	36	110	12		
3ALC 120 015 075	3ALCC 120 015 075	12 X R1.5	30	-	75	12		
3ALC 120 015 110	3ALCC 120 015 110	12 X R1.5	13	36	110	12		
3ALC 120 020 075	3ALCC 120 020 075	12 X R2	30	-	75	12		
3ALC 120 020 110	3ALCC 120 020 110	12 X R2	13	36	110	12		
3ALC 120 025 110	3ALCC 120 025 110	12 X R2.5	13	36	110	12		
3ALC 120 030 075	3ALCC 120 030 075	12 X R3	30	-	75	12		
3ALC 120 030 110	3ALCC 120 030 110	12 X R3	13	36	110	12		
3ALC 120 040 075	3ALCC 120 040 075	12 X R4	30	-	75	12		
3ALC 120 040 110	3ALCC 120 040 110	12 X R4	13	36	110	12		
3ALC 160 005 130	3ALCC 160 005 130	16 X R0.5	17	50	130	16		
3ALC 160 010 090	3ALCC 160 010 090	16 X R1	35	-	90	16		
3ALC 160 010 130	3ALCC 160 010 130	16 X R1	17	50	130	16		
3ALC 160 020 090	3ALCC 160 020 090	16 X R2	35	-	90	16		
3ALC 160 020 130	3ALCC 160 020 130	16 X R2	17	50	130	16		





### 3날 알루미늄 고이송 황삭 전용 엔드밀

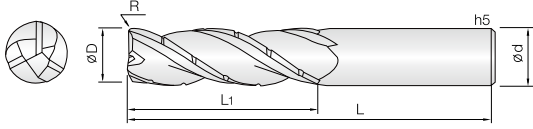

3

WC  
마립자

RTAC  
Coating

R0.2

38°  
Helix Angle

CUTTING  
DATA

R0.2                      487P

- 알루미늄, 알루미늄 합금 등 비철 비금속 계열 전용 엔드밀
- 칩 브레이커와 홀포켓을 깊게 설계하여 흡착현상을 최소화하며, 중삭 및 황삭의 고속 작업시 우수한 성능을 보입니다.
- 코팅 피막에 경도가 높고 마찰계수가 낮은 Tetrabond TAC코팅을 적용하여 내마모성이 우수합니다
- 일반 알루미늄 라핑과 다르게 피삭재의 가공면이 깨끗합니다.
- 항절력이 높은 미립자 초경합금을 채택, 엔드밀의 파손을 최소화 하였습니다.

#### • Endmills for Aluminum, AL alloys, non-ferrous and non-metallic materials

- Minimize built up edge by chip braker and deep pocket design.
- Tetrabond TAC coating provides high hardness and low friction on the coating layer
- Good surface integrity differently from competitor's AL roughing endmills.
- Minimize fracturing by high TRS fine(0.5µm) WC grade.

Condition	D Size	D Tolerance	Condition	D Size	D Tolerance
ØD ≠ Ød	Ø3 ~ 6	+0 ~ -0.01mm	ØD = Ød	Ø6	-0.005 ~ -0.015mm
	Ø8 ~ 20	+0 ~ -0.015mm		Ø8 ~ 12	-0.01 ~ -0.025mm
				Ø16 ~ 20	-0.015 ~ -0.03mm

단위 : mm

Order Number		날경	날장	전장	샤희크	비고	
		Diameter	Length of cut	Overall Length	Shank Dia	비코팅	코팅
		D × R	L1	L	d	Un coated	Coated
3ALCB 030 080 S06	3ALCBC 030 080 S06	3 X R0.2	8	55	6		
3ALCB 030 110 S06	3ALCBC 030 110 S06	3 X R0.2	11	55	6		
3ALCB 040 100 S06	3ALCBC 040 100 S06	4 X R0.2	10	55	6		
3ALCB 040 130 S06	3ALCBC 040 130 S06	4 X R0.2	13	55	6		
3ALCB 050 120 S06	3ALCBC 050 120 S06	5 X R0.2	12	55	6		
3ALCB 050 170 S06	3ALCBC 050 170 S06	5 X R0.2	17	55	6		
3ALCB 060 170 S06	3ALCBC 060 170 S06	6 X R0.2	17	60	6		
3ALCB 060 250 S06	3ALCBC 060 250 S06	6 X R0.2	25	80	6		
3ALCB 080 220 S08	3ALCBC 080 220 S08	8 X R0.2	22	70	8		
3ALCB 080 300 S08	3ALCBC 080 300 S08	8 X R0.2	30	90	8		
3ALCB 100 270 S10	3ALCBC 100 270 S10	10 X R0.2	27	75	10		
3ALCB 100 400 S10	3ALCBC 100 400 S10	10 X R0.2	40	100	10		
3ALCB 120 350 S12	3ALCBC 120 350 S12	12 X R0.2	35	80	12		
3ALCB 120 500 S12	3ALCBC 120 500 S12	12 X R0.2	50	110	12		
3ALCB 160 420 S16	3ALCBC 160 420 S16	16 X R0.2	42	100	16		
3ALCB 160 520 S16	3ALCBC 160 520 S16	16 X R0.2	52	150	16		
3ALCB 200 480 S20	3ALCBC 200 480 S20	20 X R0.2	48	100	20		
3ALCB 200 550 S20	3ALCBC 200 550 S20	20 X R0.2	55	160	20		

# 3ARE

3 Flutes Semi-Finishing & Roughing End Mills for Aluminum

## 3날 알루미늄 세미 피니싱 & 라핑 엔드밀

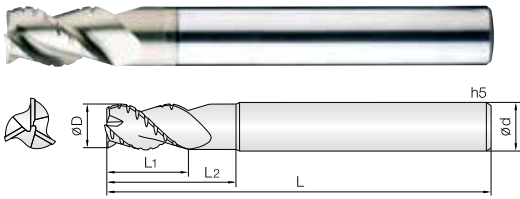

- 알루미늄, 알루미늄 합금 등 비철 비금속 계열 전용 엔드밀
- JCRO 코팅 처리하여 다양한 피삭재 가공시 인선부에 스트레스가 적으며, 내마모성 또한 향상됩니다.
- 칩 브레이커와 홈포켓을 깊게 설계하여 흡착현상을 최소화하며, 중삭 및 황삭의 고속 작업시 우수한 성능을 보입니다.
- 일반 알루미늄 라핑과 다르게 피삭재의 가공면이 깨끗합니다.
- 항절력이 높은 미립자 초경합금을 채택, 엔드밀의 파손을 최소화 하였습니다.

### High speed semi finishing and roughing Endmills for Aluminum, AL alloys, non-ferrous and non-metallic materials.

- JCRO coating provides wear resistance improvement as well as avoid edge stress in various applications.
- Minimize built up edge by chip braker and deep pocket design.
- Minimize fracturing by high TRS fine (0.5 $\mu$ m) WC grade.
- Good surface integrity differently from competitor's AL roughing endmills.



D Size	D Tolerance
Ø 6 ~ 8	-0.02 ~ -0.04mm
Ø 10 ~ 20	-0.02 ~ -0.05mm

Order Number	날경 Diameter D	날장 Length of cut L1	유효장 Effective Length L2	전장 Overall Length L	샙크 Shank Dia d	비고
3ARE 060 150 S06	6	10	15	50	6	
3ARE 060 200 S06	6	15	20	70	6	
3ARE 080 200 S08	8	15	20	60	8	
3ARE 080 250 S08	8	20	25	80	8	
3ARE 100 250 S10	10	18	25	70	10	
3ARE 100 300 S10	10	23	30	90	10	
3ARE 120 300 S12	12	20	30	80	12	
3ARE 120 400 S12	12	30	40	100	12	
3ARE 160 350 S16	16	25	35	110	16	
3ARE 160 500 S16	16	35	50	120	16	

Order Number	날경 Diameter D	날장 Length of cut L1	유효장 Effective Length L2	전장 Overall Length L	샙크 Shank Dia d	비고
3ARE 200 500 S20	20	35	50	110	20	
3ARE 200 600 S20	20	45	60	120	20	

단위 : mm

# 3ARC

3 Flutes Semi-Finishing & Roughing Corner Radius End Mills for Aluminum

## 3날 알루미늄 세미 피니싱 & 라핑 코너 레디우스 엔드밀

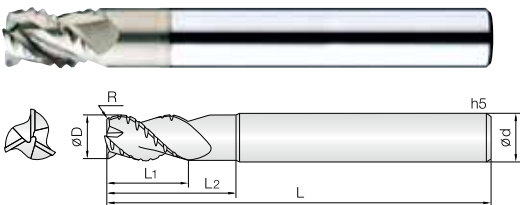

- 알루미늄, 알루미늄 합금 등 비철 비금속 계열 전용 엔드밀
- JCRO 코팅 처리하여 다양한 피삭재 가공시 인선부에 스트레스가 적으며, 내마모성 또한 향상됩니다.
- 칩 브레이커와 홈포켓을 깊게 설계하여 흡착현상을 최소화하며, 중삭 및 황삭의 고속 작업시 우수한 성능을 보입니다.
- 일반 알루미늄 라핑과 다르게 피삭재의 가공면이 깨끗합니다.
- 항절력이 높은 미립자 초경합금을 채택, 엔드밀의 파손을 최소화 하였습니다.

### High speed semi finishing and roughing End Mills for Aluminum, AL alloys, non-ferrous and non-metallic materials

- JCRO coating provides wear resistance improvement as well as avoid edge stress in various applications.
- Minimize built up edge by chip braker and deep pocket design.
- Minimize fracturing by high TRS fine (0.5 $\mu$ m) WC grade.
- Good surface integrity differently from competitor's AL roughing endmills.



D Size	D Tolerance
Ø 6 ~ 8	-0.02 ~ -0.04mm
Ø 10 ~ 20	-0.02 ~ -0.05mm

Order Number	날경 Diameter D x R	날장 Length of cut L1	유효장 Effective Length L2	전장 Overall Length L	샙크 Shank Dia d	비고
3ARC 060 005 S06	6 X R0.5	9	15	65	6	
3ARC 060 010 S06	6 X R1	9	15	65	6	
3ARC 080 005 S08	8 X R0.5	12	20	70	8	
3ARC 080 010 S08	8 X R1	12	20	70	8	
3ARC 100 010 S10	10 X R1	15	25	75	10	
3ARC 100 020 S10	10 X R2	15	25	75	10	
3ARC 120 010 S12	12 X R1	20	30	80	12	
3ARC 120 020 S12	12 X R2	20	30	80	12	
3ARC 120 030 S12	12 X R3	20	30	80	12	
3ARC 160 010 S16	16 X R1	25	35	110	16	
3ARC 160 020 S16	16 X R2	25	35	110	16	
3ARC 160 030 S16	16 X R3	25	35	110	16	

Order Number	날경 Diameter D x R	날장 Length of cut L1	유효장 Effective Length L2	전장 Overall Length L	샙크 Shank Dia d	비고
3ARC 200 020 S20	20 X R2	30	50	110	20	
3ARC 200 030 S20	20 X R3	30	50	110	20	

단위 : mm

FOR ALUMINUM

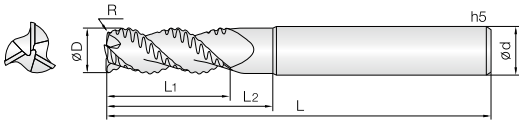

- 알루미늄, 알루미늄 합금 등 비철 비금속 계열의 고속 중삭 및 황삭
- 칩 브레이커와 홈포켓을 깊게 설계하여 흠착현상을 최소화하며, 중삭 및 황삭의 고속 작업시 우수한 성능을 보입니다.
- 코팅피막에 경도가 높고 마찰계수가 낮은 Tetrabond TAC코팅을 적용하여 내마모성이 우수하며, 피삭재의 표면조도가 월등히 우수합니다.
- 항절력이 높은 미립자 초경합금을 채택하여 고이송 작업시 엔드밀의 파손을 최소화 하였습니다.

- High speed semi finishing and roughing Endmills for Aluminum, AL alloys, non-ferrous and non-metallic materials
- Minimize built up edge by chip braker and deep pocket design.
- Tetrabond TAC coating provides excellent work surface finish by high hardness and low friction.
- Minimize fracturing at high feed by high TRS fine WC grade.

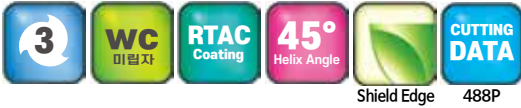

D Size	D Tolerance
Ø 4 ~ 8	-0.02 ~ -0.04mm
Ø 10 ~ 20	-0.02 ~ -0.05mm

단위 : mm

Order Number		날경 Diameter	날장 Length of cut	유효장 Effective Length	전장 Overall Length	샤프크 Shank Dia	비고	
비코팅 Un coated	RTAC 코팅 RTAC Coated	D	L1	L2	L	d	비코팅 Un coated	코팅 Coated
3ARO 040 080 S06	3AROC 040 080 S06	4	8	-	50	6		
3ARO 040 150 S06	3AROC 040 150 S06	4	10	15	60	6		
3ARO 050 100 S06	3AROC 050 100 S06	5	10	-	60	6		
3ARO 050 200 S06	3AROC 050 200 S06	5	15	20	60	6		
3ARO 060 120 S06	3AROC 060 120 S06	6	12	-	60	6		
New 3ARO 060 150 S06	New 3AROC 060 150 S06	6	15	-	60	6		
3ARO 060 210 S06	3AROC 060 210 S06	6	16	21	65	6		
New 3ARO 060 250 080	New 3AROC 060 250 080	6	25	-	80	6		
3ARO 080 160 S08	3AROC 080 160 S08	8	16	-	70	8		
New 3ARO 080 200 S08	New 3AROC 080 200 S08	8	20	-	70	8		
3ARO 080 270 S08	3AROC 080 270 S08	8	21	27	70	8		
New 3ARO 080 300 S08	New 3AROC 080 300 S08	8	30	-	90	8		
3ARO 100 200 S10	3AROC 100 200 S10	10	20	-	70	10		
New 3ARO 100 250 S10	New 3AROC 100 250 S10	10	25	-	70	10		
3ARO 100 310 S10	3AROC 100 310 S10	10	26	31	75	10		
New 3ARO 100 400 S10	New 3AROC 100 400 S10	10	40	-	100	10		
3ARO 120 240 S12	3AROC 120 240 S12	12	24	-	75	12		
New 3ARO 120 300 S12	New 3AROC 120 300 S12	12	30	-	80	12		
3ARO 120 380 S12	3AROC 120 380 S12	12	30	38	80	12		
New 3ARO 120 500 S12	New 3AROC 120 500 S12	12	50	-	110	12		
New 3ARO 140 350 S14	New 3AROC 140 350 S14	14	35	-	90	14		
3ARO 160 320 S16	3AROC 160 320 S16	16	32	-	100	16		
New 3ARO 160 420 S16	New 3AROC 160 420 S16	16	42	-	100	16		
3ARO 160 450 S16	3AROC 160 450 S16	16	36	45	100	16		
New 3ARO 160 520 S16	New 3AROC 160 520 S16	16	52	-	150	16		
New 3ARO 180 450 S18	New 3AROC 180 450 S18	18	45	-	100	18		
New 3ARO 200 480 S20	New 3AROC 200 480 S20	20	48	-	100	20		
3ARO 200 550 S20	3AROC 200 550 S20	20	41	55	110	20		
New 3ARO 200 550 160	New 3AROC 200 550 160	20	55	-	160	20		



3날 임펠라 가공용 테이퍼 볼 엔드밀

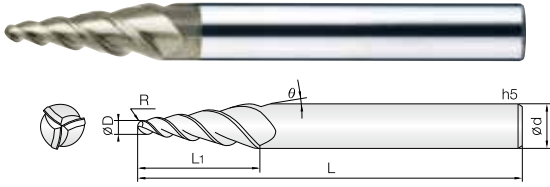

- 프리하드강, 일반강, 주물, 비철합금 가공 엔드밀
- JCRO 코팅 처리하여 다양한 피삭재 가공시 인선부에 스트레스가 적으며, 내마모성 또한 향상됩니다.
- 공구의 교체없이 밀면과 경사면의 정삭, 황삭 가공이 동시에 가능합니다.
- 임펠라, 브리스크, 타이어 프로파일, 터빈날 등 3축과 5축의 편측각이 있는 부품 가공에 적합합니다.

• Pre-hardened steels, Cast irons, Non-metallic materials

- JCRO coating provides wear resistance improvement as well as avoid edge stress in various applications.
- Suitable for special components with 3 axes and 5 axes sector such as impellers, blisks, tire profiles, turbine blades.
- Available for simultaneous machining of roughing and finishing with only one tool.

3

WC  
미립자

JCRO  
Coating

R  
± 0.005

R  
± 0.01

35°  
Helix Angle

CUTTING  
DATA

0.5R ~ 1R    2R ~ 3R    489P

단위 : mm

Order Number	날경 Diameter R × D	각도 Angle θ	날장 Length of cut L1	전장 Overall Length L	샙크 Shank Dia d	비고	Order Number	날경 Diameter R × D	각도 Angle θ	날장 Length of cut L1	전장 Overall Length L	샙크 Shank Dia d	비고
3TBIC 010 010 120	R0.5 X 1	1°	12	50	6		3TBIC 040 040 300	R2 X 4	4°	30	75	8	
3TBIC 010 010 200	R0.5 X 1	1°	20	60	6		3TBIC 040 050 200	R2 X 4	5°	20	70	8	
3TBIC 010 020 150	R0.5 X 1	2°	15	55	6		3TBIC 040 050 320	R2 X 4	5°	32	80	10	
3TBIC 010 020 200	R0.5 X 1	2°	20	60	6		3TBIC 040 060 200	R2 X 4	6°	20	70	8	
3TBIC 010 030 150	R0.5 X 1	3°	15	55	6		3TBIC 040 060 300	R2 X 4	6°	30	80	10	
3TBIC 010 030 200	R0.5 X 1	3°	20	60	6		3TBIC 040 070 180	R2 X 4	7°	18	70	8	
3TBIC 010 040 200	R0.5 X 1	4°	20	60	6		3TBIC 040 070 260	R2 X 4	7°	26	80	10	
3TBIC 010 050 200	R0.5 X 1	5°	20	60	6		3TBIC 040 080 230	R2 X 4	8°	23	75	10	
3TBIC 010 060 200	R0.5 X 1	6°	20	60	6		3TBIC 060 010 320	R3 X 6	1°	32	75	8	
3TBIC 010 070 200	R0.5 X 1	7°	20	60	6		3TBIC 060 020 300	R3 X 6	2°	30	75	8	
3TBIC 010 080 180	R0.5 X 1	8°	18	60	6		3TBIC 060 030 220	R3 X 6	3°	22	75	8	
3TBIC 020 010 120	R1 X 2	1°	12	50	6		3TBIC 060 030 320	R3 X 6	3°	32	80	10	
3TBIC 020 010 200	R1 X 2	1°	20	60	6		3TBIC 060 030 400	R3 X 6	3°	40	90	10	
3TBIC 020 020 150	R1 X 2	2°	15	55	6		3TBIC 060 040 250	R3 X 6	4°	25	75	10	
3TBIC 020 020 200	R1 X 2	2°	20	60	6		3TBIC 060 040 310	R3 X 6	4°	31	80	10	
3TBIC 020 030 150	R1 X 2	3°	15	55	6		3TBIC 060 050 210	R3 X 6	5°	21	75	10	
3TBIC 020 030 200	R1 X 2	3°	20	60	6		3TBIC 060 050 320	R3 X 6	5°	32	80	12	
3TBIC 020 030 300	R1 X 2	3°	30	70	6		3TBIC 060 060 210	R3 X 6	6°	21	75	10	
3TBIC 020 040 200	R1 X 2	4°	20	60	6		3TBIC 060 060 310	R3 X 6	6°	31	80	12	
3TBIC 020 050 200	R1 X 2	5°	20	60	6		3TBIC 060 070 190	R3 X 6	7°	19	75	10	
3TBIC 020 050 300	R1 X 2	5°	30	75	8		3TBIC 060 070 270	R3 X 6	7°	27	80	12	
3TBIC 020 060 190	R1 X 2	6°	19	60	6								
3TBIC 020 060 290	R1 X 2	6°	29	75	8								
3TBIC 020 070 160	R1 X 2	7°	16	60	6								
3TBIC 020 070 250	R1 X 2	7°	25	70	8								
3TBIC 020 080 150	R1 X 2	8°	15	60	6								
3TBIC 020 080 220	R1 X 2	8°	22	70	8								
3TBIC 030 010 200	R1.5 X 3	1°	20	60	6								
3TBIC 030 010 320	R1.5 X 3	1°	32	75	6								
3TBIC 030 020 200	R1.5 X 3	2°	20	60	6								
3TBIC 030 030 200	R1.5 X 3	3°	20	60	6								
3TBIC 030 030 300	R1.5 X 3	3°	30	70	6								
3TBIC 030 030 390	R1.5 X 3	3°	39	80	8								
3TBIC 030 040 200	R1.5 X 3	4°	20	65	6								
3TBIC 030 050 180	R1.5 X 3	5°	18	60	6								
3TBIC 030 050 300	R1.5 X 3	5°	30	75	8								
3TBIC 030 060 150	R1.5 X 3	6°	15	60	6								
3TBIC 030 060 250	R1.5 X 3	6°	25	70	8								
3TBIC 030 070 190	R1.5 X 3	7°	19	70	8								
3TBIC 030 070 300	R1.5 X 3	7°	30	80	10								
3TBIC 030 080 190	R1.5 X 3	8°	19	70	8								
3TBIC 030 080 260	R1.5 X 3	8°	26	75	10								
3TBIC 040 010 200	R2 X 4	1°	20	60	6								
3TBIC 040 010 320	R2 X 4	1°	32	75	6								
3TBIC 040 020 200	R2 X 4	2°	20	60	6								
3TBIC 040 020 300	R2 X 4	2°	30	70	6								
3TBIC 040 030 210	R2 X 4	3°	21	70	6								
3TBIC 040 030 320	R2 X 4	3°	32	80	8								
3TBIC 040 030 400	R2 X 4	3°	40	90	8								
3TBIC 040 040 200	R2 X 4	4°	20	70	8								

TAPER





단위: mm

Order Number	날경 Diameter R x D	각도 Angle $\theta$	날장 Length of cut L1	전장 Overall Length L	생크 Shank Dia d	비고	Order Number	날경 Diameter R x D	각도 Angle $\theta$	날장 Length of cut L1	전장 Overall Length L	생크 Shank Dia d	비고
2CTB 030 100 120	1.5R X 3	10°	12	60	8								
2CTB 030 150 120	1.5R X 3	15°	12	70	10								
2CTB 040 003 160	2R X 4	0°30	16	70	8								
2CTB 040 010 160	2R X 4	1°	16	70	8								
2CTB 040 013 160	2R X 4	1°30	16	70	8								
2CTB 040 020 160	2R X 4	2°	16	70	8								
2CTB 040 030 160	2R X 4	3°	16	70	8								
2CTB 040 040 160	2R X 4	4°	16	70	8								
2CTB 040 050 160	2R X 4	5°	16	70	8								
2CTB 040 070 160	2R X 4	7°	16	70	8								
2CTB 040 100 160	2R X 4	10°	16	70	10								
2CTB 040 150 160	2R X 4	15°	16	80	12								
2CTB 050 003 200	2.5R X 5	0°30	20	75	8								
2CTB 050 010 200	2.5R X 5	1°	20	75	8								
2CTB 050 013 200	2.5R X 5	1°30	20	75	8								
2CTB 050 020 200	2.5R X 5	2°	20	75	8								
2CTB 050 030 200	2.5R X 5	3°	20	75	8								
2CTB 050 040 200	2.5R X 5	4°	20	75	8								
2CTB 050 050 200	2.5R X 5	5°	20	80	10								
2CTB 050 070 200	2.5R X 5	7°	20	80	10								
2CTB 060 003 240	3R X 6	0°30	24	80	10								
2CTB 060 010 240	3R X 6	1°	24	80	10								
2CTB 060 013 240	3R X 6	1°30	24	80	10								
2CTB 060 020 240	3R X 6	2°	24	80	10								
2CTB 060 030 240	3R X 6	3°	24	80	10								
2CTB 060 040 240	3R X 6	4°	24	80	10								
2CTB 060 050 240	3R X 6	5°	24	90	12								
2CTB 060 070 240	3R X 6	7°	24	90	12								

TAPER



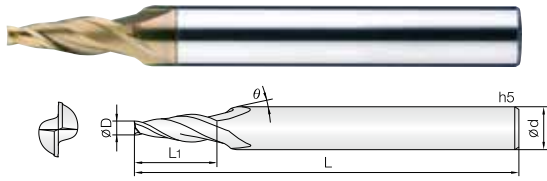

- 고경도강(HRc52이하), 프리하드강 계열의 고정밀 가공 엔드밀
- 실리콘계 코팅(Si) 처리하여 내마모성이 우수합니다.
- 고정밀 공차 적용으로 초정밀 가공에 적합합니다.
- 날부 인선의 조도가 뛰어나 피삭재의 면조도가 우수합니다.
- 항절력이 높은 미립자 초경합금(0.5 $\mu$ m)을 채택, 엔드밀의 파손을 최소화 하였습니다.

#### • Endmills for pre-hardened and hardened steels(~HRc52)

- Good wear resistance by high quality Si-based PVD coating.
- High precise edge tolerance.
- Very nice work surface finish.
- Minimize fracturing by high TRS fine(0.5 $\mu$ m) WC grade.



Shield Edge 491P

D Size	D Tolerance
$\varnothing 0.2 \sim 4$	+0 ~ -0.01mm
$\varnothing 6 \sim 8$	-0.01 ~ -0.025mm

Order Number	날경 Diameter D	각도 Angle $\theta$	날장 Length of cut L1	전장 Overall Length L	생크 Shank Dia d	비고	Order Number	날경 Diameter D	각도 Angle $\theta$	날장 Length of cut L1	전장 Overall Length L	생크 Shank Dia d	비고
2CTE 002 003 010	0.2	0°30'	1	40	4		2CTE 007 030 025	0.7	3°	2.5	40	4	
2CTE 002 010 010	0.2	1°	1	40	4		2CTE 007 050 025	0.7	5°	2.5	40	4	
2CTE 002 013 010	0.2	1°30'	1	40	4		2CTE 007 070 030	0.7	7°	3	40	4	
2CTE 002 020 010	0.2	2°	1	40	4		2CTE 007 100 030	0.7	10°	3	40	4	
2CTE 002 030 010	0.2	3°	1	40	4		2CTE 007 150 030	0.7	15°	3	40	4	
2CTE 002 050 010	0.2	5°	1	40	4		2CTE 007 200 030	0.7	20°	3	40	4	
2CTE 002 070 010	0.2	7°	1	40	4		2CTE 008 003 030	0.8	0°30'	3	40	4	
2CTE 002 100 010	0.2	10°	1	40	4		2CTE 008 010 030	0.8	1°	3	40	4	
2CTE 002 150 010	0.2	15°	1	40	4		2CTE 008 013 030	0.8	1°30'	3	40	4	
2CTE 003 003 012	0.3	0°30'	1.2	40	4		2CTE 008 020 030	0.8	2°	3	40	4	
2CTE 003 010 012	0.3	1°	1.2	40	4		2CTE 008 030 030	0.8	3°	3	40	4	
2CTE 003 013 012	0.3	1°30'	1.2	40	4		2CTE 008 050 030	0.8	5°	3	40	4	
2CTE 003 020 012	0.3	2°	1.2	40	4		2CTE 008 070 030	0.8	7°	3	40	4	
2CTE 003 030 012	0.3	3°	1.2	40	4		2CTE 008 100 030	0.8	10°	3	40	4	
2CTE 003 050 012	0.3	5°	1.2	40	4		2CTE 008 150 030	0.8	15°	3	40	4	
2CTE 003 070 015	0.3	7°	1.5	40	4		2CTE 008 200 030	0.8	20°	3	40	4	
2CTE 003 100 015	0.3	10°	1.5	40	4		2CTE 010 003 040	1	0°30'	4	45	4	
2CTE 003 150 015	0.3	15°	1.5	40	4		2CTE 010 010 040	1	1°	4	45	4	
2CTE 004 003 016	0.4	0°30'	1.6	40	4		2CTE 010 013 040	1	1°30'	4	45	4	
2CTE 004 010 016	0.4	1°	1.6	40	4		2CTE 010 020 040	1	2°	4	45	4	
2CTE 004 013 016	0.4	1°30'	1.6	40	4		2CTE 010 030 040	1	3°	4	45	4	
2CTE 004 020 016	0.4	2°	1.6	40	4		2CTE 010 050 040	1	5°	4	45	4	
2CTE 004 030 016	0.4	3°	1.6	40	4		2CTE 010 070 040	1	7°	4	45	4	
2CTE 004 050 016	0.4	5°	1.6	40	4		2CTE 010 100 040	1	10°	4	45	4	
2CTE 004 070 020	0.4	7°	2	40	4		2CTE 010 150 040	1	15°	4	50	6	
2CTE 004 100 020	0.4	10°	2	40	4		2CTE 010 200 040	1	20°	4	50	6	
2CTE 004 150 020	0.4	15°	2	40	4		2CTE 015 003 050	1.5	0°30'	5	45	4	
2CTE 005 003 020	0.5	0°30'	2	40	4		2CTE 015 010 050	1.5	1°	5	45	4	
2CTE 005 010 020	0.5	1°	2	40	4		2CTE 015 013 060	1.5	1°30'	6	45	4	
2CTE 005 013 020	0.5	1°30'	2	40	4		2CTE 015 020 070	1.5	2°	7	45	4	
2CTE 005 020 020	0.5	2°	2	40	4		2CTE 015 030 080	1.5	3°	8	45	4	
2CTE 005 030 020	0.5	3°	2	40	4		2CTE 015 050 100	1.5	5°	10	50	4	
2CTE 005 050 020	0.5	5°	2	40	4		2CTE 015 070 100	1.5	7°	10	50	4	
2CTE 005 070 025	0.5	7°	2.5	40	4		2CTE 015 100 100	1.5	10°	10	50	6	
2CTE 005 100 025	0.5	10°	2.5	40	4		2CTE 015 150 060	1.5	15°	6	50	6	
2CTE 005 150 025	0.5	15°	2.5	40	4		2CTE 015 200 060	1.5	20°	6	50	6	
2CTE 005 200 025	0.5	20°	2.5	40	4		2CTE 020 003 060	2	0°30'	6	45	4	
2CTE 006 003 020	0.6	0°30'	2	40	4		2CTE 020 010 060	2	1°	6	45	4	
2CTE 006 020 010	0.6	1°	2	40	4		2CTE 020 013 060	2	1°30'	6	45	4	
2CTE 006 013 020	0.6	1°30'	2	40	4		2CTE 020 020 080	2	2°	8	45	4	
2CTE 006 020 020	0.6	2°	2	40	4		2CTE 020 030 100	2	3°	10	50	4	
2CTE 006 030 020	0.6	3°	2	40	4		2CTE 020 050 100	2	5°	10	50	4	
2CTE 006 050 020	0.6	5°	2	40	4		2CTE 020 070 100	2	7°	10	50	6	
2CTE 006 070 025	0.6	7°	2.5	40	4		2CTE 020 100 110	2	10°	11	50	6	
2CTE 006 100 025	0.6	10°	2.5	40	4		2CTE 020 150 070	2	15°	7	50	6	
2CTE 006 150 025	0.6	15°	2.5	40	4		2CTE 020 200 070	2	20°	7	50	8	
2CTE 006 200 025	0.6	20°	2.5	40	4		2CTE 025 003 080	2.5	0°30'	8	45	6	
2CTE 007 010 025	0.7	1°	2.5	40	4		2CTE 025 010 100	2.5	1°	10	50	6	
2CTE 007 013 025	0.7	1°30'	2.5	40	4		2CTE 025 013 100	2.5	1°30'	10	50	6	
2CTE 007 020 025	0.7	2°	2.5	40	4		2CTE 025 020 120	2.5	2°	12	50	6	

단위 : mm

TAPER

단위 : mm

Order Number	날경 Diameter D	각도 Angle θ	날장 Length of cut L1	전장 Overall Length L	생크 Shank Dia d	비고	Order Number	날경 Diameter D	각도 Angle θ	날장 Length of cut L1	전장 Overall Length L	생크 Shank Dia d	비고
2CTE 025 030 120	2.5	3°	12	50	6								
2CTE 025 050 120	2.5	5°	12	50	6								
2CTE 025 070 120	2.5	7°	12	50	6								
2CTE 025 100 100	2.5	10°	10	50	6								
2CTE 025 150 100	2.5	15°	10	60	8								
2CTE 025 200 100	2.5	20°	10	70	10								
2CTE 030 003 120	3	0°30'	12	50	6								
2CTE 030 010 120	3	1°	12	50	6								
2CTE 030 013 120	3	1°30'	12	50	6								
2CTE 030 020 120	3	2°	12	50	6								
2CTE 030 030 120	3	3°	12	50	6								
2CTE 030 050 120	3	5°	12	50	6								
2CTE 030 070 120	3	7°	12	50	6								
2CTE 030 100 080	3	10°	8	50	6								
2CTE 030 150 090	3	15°	9	60	8								
2CTE 030 200 090	3	20°	9	70	10								
2CTE 040 003 150	4	0°30'	15	60	6								
2CTE 040 010 150	4	1°	15	60	6								
2CTE 040 013 150	4	1°30'	15	60	6								
2CTE 040 020 150	4	2°	15	60	6								
2CTE 040 030 180	4	3°	18	60	6								
2CTE 040 050 230	4	5°	23	65	8								
2CTE 040 070 240	4	7°	24	75	10								
2CTE 040 100 220	4	10°	22	75	12								
2CTE 060 003 200	6	0°30'	20	65	8								
2CTE 060 010 200	6	1°	20	65	8								
2CTE 060 013 200	6	1°30'	20	65	8								
2CTE 060 020 200	6	2°	20	65	8								
2CTE 060 030 190	6	3°	19	65	8								
2CTE 060 050 230	6	5°	23	75	10								
2CTE 060 070 240	6	7°	24	75	12								
2CTE 060 100 170	6	10°	17	75	12								
2CTE 070 003 250	7	0°30'	25	70	8								
2CTE 070 010 250	7	1°	25	70	8								
2CTE 070 013 250	7	1°30'	25	70	10								
2CTE 070 030 280	7	3°	28	80	10								
2CTE 070 050 280	7	5°	28	80	12								
2CTE 080 003 320	8	0°30'	32	90	10								
2CTE 080 010 350	8	1°	35	90	10								
2CTE 080 013 350	8	1°30'	35	90	10								
2CTE 080 020 280	8	2°	28	75	10								
2CTE 080 030 350	8	3°	35	90	12								
2CTE 080 050 450	8	5°	45	100	16								
2CTE 080 070 320	8	7°	32	90	16								
2CTE 080 100 340	8	10°	34	100	20								

TAPER

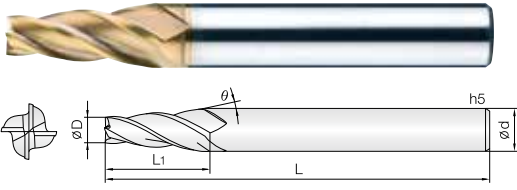

- 고경도강(HRc52이하), 프리하든강 계열의 고정밀 가공 엔드밀
- 실리콘계 코팅(Si) 처리하여 내마모성이 우수합니다.
- 고정밀 공차 적용으로 초정밀 가공에 적합합니다.
- 날부 인선의 조도가 뛰어나 피삭재의 면조도가 우수합니다.
- 항절력이 높은 미립자 초경합금(0.5 $\mu$ m)을 채택, 엔드밀의 파손을 최소화 하였습니다.

#### • Endmills for pre-hardened and hardened steels(~HRc52)

- Good wear resistance by high quality Si-based PVD coating.
- High precise edge tolerance.
- Very nice work surface finish.
- Minimize fracturing by high TRS fine(0.5 $\mu$ m) WC grade.



Shield Edge 492P

D Size	D Tolerance
Ø 0.3 ~ 5	+0 ~ -0.01mm
Ø 6 ~ 8	-0.01 ~ -0.025mm

단위 : mm

Order Number	날경 Diameter D	각도 Angle $\theta$	날장 Length of cut L1	전장 Overall Length L	생크 Shank Dia d	비고	Order Number	날경 Diameter D	각도 Angle $\theta$	날장 Length of cut L1	전장 Overall Length L	생크 Shank Dia d	비고
4CTE 030 003 110	3	0°30	11	50	6								
4CTE 030 010 110	3	1°	11	50	6								
4CTE 030 013 110	3	1°30	11	50	6								
4CTE 030 020 150	3	2°	15	60	6								
4CTE 030 023 150	3	2°30	15	60	6								
4CTE 030 030 150	3	3°	15	60	6								
4CTE 030 050 150	3	5°	15	60	6								
4CTE 030 070 120	3	7°	12	60	6								
4CTE 030 100 190	3	10°	19	80	10								
4CTE 040 003 150	4	0°30	15	60	6								
4CTE 040 010 150	4	1°	15	60	6								
4CTE 040 013 150	4	1°30	15	60	6								
4CTE 040 020 180	4	2°	18	60	6								
4CTE 040 023 180	4	2°30	18	60	6								
4CTE 040 030 180	4	3°	18	60	6								
4CTE 040 050 230	4	5°	23	65	8								
4CTE 040 070 250	4	7°	25	75	10								
4CTE 050 003 180	5	0°30	18	60	6								
4CTE 050 010 180	5	1°	18	60	6								
4CTE 050 013 180	5	1°30	18	60	6								
4CTE 050 020 150	5	2°	15	60	6								
4CTE 050 023 200	5	2°30	20	65	8								
4CTE 050 030 210	5	3°	21	65	8								
4CTE 050 050 280	5	5°	28	80	10								
4CTE 050 070 280	5	7°	28	80	12								
4CTE 052 0147 120	5.2	1°47	12	60	6								
4CTE 060 003 200	6	0°30	20	65	8								
4CTE 060 010 200	6	1°	20	65	8								
4CTE 060 013 200	6	1°30	20	65	8								
4CTE 060 020 200	6	2°	20	65	8								
4CTE 060 023 200	6	2°30	20	65	8								
4CTE 060 030 260	6	3°	26	75	10								
4CTE 060 050 230	6	5°	23	75	10								
4CTE 060 070 240	6	7°	24	80	12								
4CTE 060 100 390	6	10°	39	110	20								
4CTE 080 003 250	8	0°30	25	75	10								
4CTE 080 010 250	8	1°	25	75	10								
4CTE 080 013 250	8	1°30	25	75	10								
4CTE 080 020 250	8	2°	25	75	10								
4CTE 080 023 230	8	2°30	23	75	10								
4CTE 080 030 300	8	3°	30	80	12								
4CTE 080 050 230	8	5°	23	85	12								
4CTE 085 0147 240	8.5	1°47	24	75	10								
4CTE 100 003 300	10	0°30	30	80	12								
4CTE 100 010 300	10	1°	30	80	12								
4CTE 100 013 300	10	1°30	30	80	12								
4CTE 100 0147 320	10	1°47	32	85	12								
4CTE 100 020 280	10	2°	28	80	12								
4CTE 100 030 400	10	3°	40	100	16								
4CTE 100 050 340	10	5°	34	100	16								

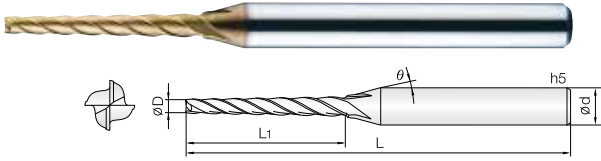

End point(2F)

- 고경도강(HRc52이하), 프리하든강 계열의 고정밀 가공 엔드밀
- 실리콘계 코팅(Si) 처리하여 내마모성이 우수합니다.
- 밑날2날 형상과 옆날4날 형상으로 깊은 홈 가공시 적합합니다.
- 고정밀 공차 적용으로 초정밀 가공에 적합합니다.
- 날부인선의 조도가 뛰어나 피삭재의 면조도가 우수합니다.
- 항절력이 높은 미립자 초경합금(0.5 $\mu$ m)을 채택, 엔드밀의 파손을 최소화 하였습니다.

#### • Endmills for pre-hardened and hardened steels(~HRc52)

- Good wear resistance by Si-based PVD coating.
- Optimum for deep grooving by 2bottom edge with 4flutes.
- High precise edge tolerance.
- Very nice work surface finish.
- Minimize fracturing by high TRS fine(0.5 $\mu$ m) WC grade.



D Size	D Tolerance
Ø 0.5 ~ 2.5	+0 ~ -0.01mm

단위 : mm

Order Number	날경 Diameter D	각도 Angle $\theta$	날장 Length of cut L1	전장 Overall Length L	샙크 Shank Dia d	비고	Order Number	날경 Diameter D	각도 Angle $\theta$	날장 Length of cut L1	전장 Overall Length L	샙크 Shank Dia d	비고
4RTE 005 030 040	0.5	0°30	4	45	4		4RTE 012 045 100	1.2	0°45	10	45	4	
4RTE 005 030 060	0.5	0°30	6	45	4		4RTE 012 045 120	1.2	0°45	12	45	4	
4RTE 005 045 040	0.5	0°45	4	45	4		4RTE 012 045 160	1.2	0°45	16	50	4	
4RTE 005 045 060	0.5	0°45	6	45	4		4RTE 012 100 080	1.2	1°	8	45	4	
4RTE 005 100 040	0.5	1°	4	45	4		4RTE 012 100 100	1.2	1°	10	45	4	
4RTE 005 100 060	0.5	1°	6	45	4		4RTE 012 100 120	1.2	1°	12	45	4	
4RTE 006 030 040	0.6	0°30	4	45	4		4RTE 012 100 160	1.2	1°	16	50	4	
4RTE 006 030 060	0.6	0°30	6	45	4		4RTE 015 030 060	1.5	0°30	6	45	4	
4RTE 006 045 040	0.6	0°45	4	45	4		4RTE 015 030 100	1.5	0°30	10	45	4	
4RTE 006 045 060	0.6	0°45	6	45	4		4RTE 015 030 160	1.5	0°30	16	50	4	
4RTE 006 100 040	0.6	1°	4	45	4		4RTE 015 030 200	1.5	0°30	20	60	4	
4RTE 006 100 060	0.6	1°	6	45	4		4RTE 015 100 060	1.5	1°	6	45	4	
4RTE 007 030 060	0.7	0°30	6	45	4		4RTE 015 100 100	1.5	1°	10	45	4	
4RTE 007 030 080	0.7	0°30	8	45	4		4RTE 015 100 160	1.5	1°	16	50	4	
4RTE 007 045 060	0.7	0°45	6	45	4		4RTE 015 100 200	1.5	1°	20	60	4	
4RTE 007 045 080	0.7	0°45	8	45	4		4RTE 015 100 250	1.5	1°	25	60	4	
4RTE 007 100 060	0.7	1°	6	45	4		4RTE 015 130 060	1.5	1°30	6	45	4	
4RTE 007 100 080	0.7	1°	8	45	4		4RTE 015 130 100	1.5	1°30	10	45	4	
4RTE 008 030 060	0.8	0°30	6	45	4		4RTE 015 130 160	1.5	1°30	16	50	4	
4RTE 008 030 080	0.8	0°30	8	45	4		4RTE 015 130 200	1.5	1°30	20	60	4	
4RTE 008 030 100	0.8	0°30	10	45	4		4RTE 015 130 250	1.5	1°30	25	60	4	
4RTE 008 045 060	0.8	0°45	6	45	4		4RTE 020 030 100	2	0°30	10	45	4	
4RTE 008 045 080	0.8	0°45	8	45	4		4RTE 020 030 160	2	0°30	16	50	4	
4RTE 008 045 100	0.8	0°45	10	45	4		4RTE 020 030 200	2	0°30	20	60	4	
4RTE 008 100 060	0.8	1°	6	45	4		4RTE 020 030 250	2	0°30	25	60	4	
4RTE 008 100 080	0.8	1°	8	45	4		4RTE 020 100 100	2	1°	10	45	4	
4RTE 008 100 100	0.8	1°	10	45	4		4RTE 020 100 160	2	1°	16	50	4	
4RTE 009 030 060	0.9	0°30	6	45	4		4RTE 020 100 200	2	1°	20	60	4	
4RTE 009 030 080	0.9	0°30	8	45	4		4RTE 020 100 250	2	1°	25	60	4	
4RTE 009 030 100	0.9	0°30	10	45	4		4RTE 020 130 100	2	1°30	10	45	4	
4RTE 009 045 060	0.9	0°45	6	45	4		4RTE 020 130 160	2	1°30	16	50	4	
4RTE 009 045 080	0.9	0°45	8	45	4		4RTE 020 130 200	2	1°30	20	60	4	
4RTE 009 045 100	0.9	0°45	10	45	4		4RTE 020 130 250	2	1°30	25	60	4	
4RTE 009 100 060	0.9	1°	6	45	4		4RTE 025 030 100	2.5	0°30	10	45	4	
4RTE 009 100 080	0.9	1°	8	45	4		4RTE 025 030 160	2.5	0°30	16	50	4	
4RTE 009 100 100	0.9	1°	10	45	4		4RTE 025 030 200	2.5	0°30	20	60	4	
4RTE 010 030 080	1	0°30	8	45	4		4RTE 025 030 250	2.5	0°30	25	60	4	
4RTE 010 030 100	1	0°30	10	45	4		4RTE 025 100 100	2.5	1°	10	45	4	
4RTE 010 030 120	1	0°30	12	45	4		4RTE 025 100 160	2.5	1°	16	50	4	
4RTE 010 045 080	1	0°45	8	45	4		4RTE 025 100 200	2.5	1°	20	60	4	
4RTE 010 045 100	1	0°45	10	45	4		4RTE 025 100 250	2.5	1°	25	60	4	
4RTE 010 045 120	1	0°45	12	45	4		4RTE 025 130 100	2.5	1°30	10	45	4	
4RTE 010 100 080	1	1°	8	45	4		4RTE 025 130 160	2.5	1°30	16	50	4	
4RTE 010 100 100	1	1°	10	45	4		4RTE 025 130 200	2.5	1°30	20	60	4	
4RTE 010 100 120	1	1°	12	45	4		4RTE 025 130 250	2.5	1°30	25	60	4	
4RTE 012 030 080	1.2	0°30	8	45	4								
4RTE 012 030 100	1.2	0°30	10	45	4								
4RTE 012 030 120	1.2	0°30	12	45	4								
4RTE 012 030 160	1.2	0°30	16	50	4								
4RTE 012 045 080	1.2	0°45	8	45	4								

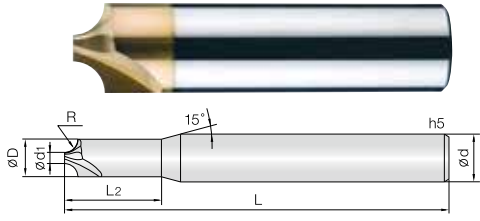

- HRc52이하의 고경도강, 프리하든강, 공구강, 주철 등 피삭재 가공
- 실리콘계 코팅 (Si) 처리하여 내마모성이 우수합니다.
- 고정밀 공차 적용으로 초정밀 가공에 적합합니다.
- 날부인선의 조도가 뛰어나 피삭재의 면조도가 우수합니다.
- 항절력이 높은 미립자 초경합금(0.5 $\mu$ m)을 채택, 엔드밀의 파손을 최소화 하였습니다.

- **Endmills for various work materials, hardened steels (HRc~52), pre-hardened steels, tool steels and cast irons**
- Good wear resistance by Si-based PVD coating.
- High precise edge tolerance.
- Very nice work surface finish.
- Minimize fracturing by high TRS fine(0.5 $\mu$ m) WC grade.

0.1 ~ 2.5R    3 ~ 8R    493P

D Size	D Tolerance	d1 Size	d1 Tolerance
ø 0.8 ~ 6	+0 ~ -0.01mm	ø 0.5 ~ 0.9	+0 ~ -0.01mm
ø 7 ~ 20	+0 ~ -0.015mm	ø 1.4 ~ 5.9	+0 ~ -0.02mm

단위 : mm

Order Number	선단경 Diameter d1×R	외경 Length of cut D	유효장 Effective Length L2	전장 Overall Length L	생크 Shank Dia d	비고	Order Number	선단경 Diameter d1×R	외경 Length of cut D	유효장 Effective Length L2	전장 Overall Length L	생크 Shank Dia d	비고
2CRC 005 001 S04	0.5 X R0.1	0.8	2.5	45	4								
2CRC 005 0015 S04	0.5 X R0.15	0.9	2.5	45	4								
2CRC 005 002 S04	0.5 X R0.2	1	2.5	45	4								
2CRC 005 0025 S04	0.5 X R0.25	1.1	2.5	45	4								
2CRC 005 003 S04	0.5 X R0.3	1.2	2.5	45	4								
2CRC 005 0035 S04	0.5 X R0.35	1.3	2.5	45	4								
2CRC 005 004 S04	0.5 X R0.4	1.4	2.5	45	4								
2CRC 005 0045 S04	0.5 X R0.45	1.5	2.5	45	4								
2CRC 005 005 S04	0.5 X R0.5	1.6	2.5	45	4								
2CRC 009 005 S04	0.9 X R0.5	2	3	45	4								
2CRC 049 005 S06	4.9 X R0.5	6	-	50	6								
2CRC 005 0055 S04	0.5 X R0.55	1.7	3	45	4								
2CRC 005 006 S04	0.5 X R0.6	1.8	3	45	4								
2CRC 005 0065 S04	0.5 X R0.65	1.9	3	45	4								
2CRC 005 007 S04	0.5 X R0.7	2	3	45	4								
2CRC 009 0075 S04	0.9 X R0.75	2.5	4	45	4								
2CRC 009 008 S04	0.9 X R0.8	2.6	4	45	4								
2CRC 009 0085 S04	0.9 X R0.85	2.7	4	45	4								
2CRC 009 009 S04	0.9 X R0.9	2.8	4	45	4								
2CRC 009 0095 S04	0.9 X R0.95	2.9	4	45	4								
2CRC 009 010 S06	0.9 X R1	3	5	50	6								
2CRC 039 010 S06	3.9 X R1	6	-	50	6								
2CRC 059 010 S08	5.9 X R1	8	-	60	8								
2CRC 009 0125 S06	0.9 X R1.25	3.5	5	50	6								
2CRC 034 0125 S06	3.4 X R1.25	6	-	50	6								
2CRC 014 015 S06	1.4 X R1.5	4.5	8	50	6								
2CRC 049 015 S08	4.9 X R1.5	8	-	60	8								
2CRC 014 020 S06	1.4 X R2	5.5	10	50	6								
2CRC 039 020 S08	3.9 X R2	8	-	60	8								
2CRC 019 025 S08	1.9 X R2.5	7	13	60	8								
2CRC 019 030 S08	1.9 X R3	8	-	60	8								
2CRC 019 035 S10	1.9 X R3.5	9	13	70	10								
2CRC 019 040 S10	1.9 X R4	10	-	70	10								
2CRC 019 045 S12	1.9 X R4.5	11	13	80	12								
2CRC 019 050 S12	1.9 X R5	12	-	80	12								
2CRC 039 060 S16	3.9 X R6	16	-	90	16								
2CRC 059 070 S20	5.9 X R7	20	-	90	20								
2CRC 039 080 S20	3.9 X R8	20	-	90	20								



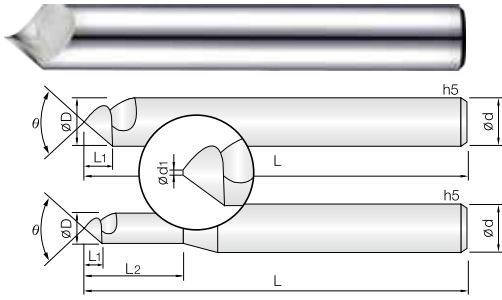

- 알루미늄 합금, 동합금, 플라스틱 등 연질 피삭재 가공
- 뛰어난 표면 조도와 버를 최소화 합니다.
- 헬릭스 타입 1날 적용하여 공구 센터의 절삭력이 뛰어납니다.
- 하나의 공구로 모든 면취가 가능하며 우수한 성능을 발휘합니다.

**Processing of soft cutting materials such as aluminum alloys, brass alloys, and plastics**

- Achieves excellent surface finish and minimizes burrs.
- Applying single-flute helix type ensures outstanding cutting force at the tool center.
- Capable of all chamfering with a single tool and demonstrates excellent performance.



494P

D Size	D Tolerance	d1 Size	d1 Tolerance
Ø 1.2 ~ 6	+0 ~ -0.01mm	Ø 0	+0.05 ~ -0mm
Ø 8 ~ 16	+0 ~ -0.015mm		

단위 : mm

Order Number		날경 Diameter D	선단경 Neck Diameter d1	각도 Angle θ	날장 Length of cut L1	유효장 Effective Length L2	전장 Overall Length L	샙크 Shank Dia d	비고
비코팅 Un coated	RTAC 코팅 RTAC Coated								
1HTE 012 600 S03	1HTEC 012 600 S03	1.2	0	60°	1	3.6	40	3	
1HTE 012 900 S03	1HTEC 012 900 S03	1.2	0	90°	0.6	3.6	40	3	
1HTE 020 600 S03	1HTEC 020 600 S03	2	0	60°	1.7	6	40	3	
1HTE 020 900 S03	1HTEC 020 900 S03	2	0	90°	1	6	40	3	
1HTE 030 600 S03	1HTEC 030 600 S03	3	0	60°	2.5	-	40	3	
1HTE 030 900 S03	1HTEC 030 900 S03	3	0	90°	1.5	-	40	3	
1HTE 030 900 100	1HTEC 030 900 100	3	0	90°	1.5	-	100	3	
1HTE 040 600 S04	1HTEC 040 600 S04	4	0	60°	3.4	-	40	4	
1HTE 040 900 S04	1HTEC 040 900 S04	4	0	90°	2	-	40	4	
1HTE 040 900 100	1HTEC 040 900 100	4	0	90°	2	-	100	4	
1HTE 060 600 S06	1HTEC 060 600 S06	6	0	60°	5.1	-	50	6	
1HTE 060 900 S06	1HTEC 060 900 S06	6	0	90°	3	-	50	6	
1HTE 060 900 100	1HTEC 060 900 100	6	0	90°	3	-	100	6	
1HTE 080 600 S08	1HTEC 080 600 S08	8	0	60°	6.9	-	60	8	
1HTE 080 900 S08	1HTEC 080 900 S08	8	0	90°	4	-	60	8	
1HTE 080 900 150	1HTEC 080 900 150	8	0	90°	4	-	150	8	
1HTE 100 600 S10	1HTEC 100 600 S10	10	0	60°	8.6	-	70	10	
1HTE 100 900 S10	1HTEC 100 900 S10	10	0	90°	5	-	70	10	
1HTE 100 900 150	1HTEC 100 900 150	10	0	90°	5	-	150	10	
1HTE 120 600 S12	1HTEC 120 600 S12	12	0	60°	10.3	-	75	12	
1HTE 120 900 S12	1HTEC 120 900 S12	12	0	90°	6	-	75	12	
1HTE 120 900 150	1HTEC 120 900 150	12	0	90°	6	-	150	12	
1HTE 160 600 S16	1HTEC 160 600 S16	16	0	60°	13.8	-	80	16	
1HTE 160 900 S16	1HTEC 160 900 S16	16	0	90°	8	-	80	16	

GENERAL PURPOSE

\* 각 제품의 선단경(d1)은 완전한 Ø0이 아니므로 면취 작업시 날장의 약98%만 사용하십시오.

\* As the cutting edge diameter of each product (d1) is not 0, please use only 95% of the blade length during chamfering operations.

**가공형상에따른절삭가능여부 Available Cutting Shape**

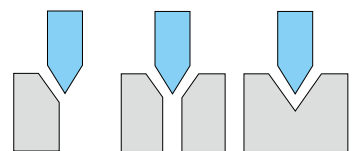

가능 (O)

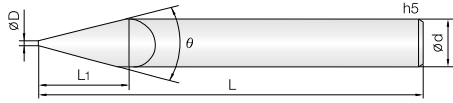

- HRC50이하의 고경도강, 프리하든강, 공구강, 주철 등 피삭재 가공
- 실리콘계 코팅 (Si) 처리하여 내마모성이 우수합니다.
- 직선날 타입 1날을 적용하여 조각NC 작업에 적합합니다.
- 다양한 날경의 적용으로 조각 작업시 효율성을 최대화 하였습니다.

- Endmills for various work materials, hardened steels(HRC~50), pre-hardened steels, tool steels and cast irons
- Good wear resistance by Si-based PVD coating.
- Optimum for NC engraving by straight type one edge.
- Maximize engraving efficiency by various edge diameter.



495P

D Size	D Tolerance
ø0	+0.05 ~ -0mm
ø0.05 ~ 0.3	0 ~ -0.02mm

단위 : mm

Order Number	날경 Diameter D	각도 Angle θ	날장 Length of cut L1	전장 Overall Length L	샙크 Shank Dia d	비고	Order Number	날경 Diameter D	각도 Angle θ	날장 Length of cut L1	전장 Overall Length L	샙크 Shank Dia d	비고
1STE 000 200 S04	0	20°	5	40	4		1STE 003 200 S04	0.3	20°	5	40	4	
1STE 000 300 S04	0	30°	5	40	4		1STE 003 300 S04	0.3	30°	5	40	4	
1STE 000 900 S04	0	90°	2	40	4		1STE 003 600 S04	0.3	60°	3.2	40	4	
1STE 000 200 S06	0	20°	5	50	6		1STE 003 900 S04	0.3	90°	1.85	40	4	
1STE 000 300 S06	0	30°	5	50	6								
1STE 000 900 S06	0	90°	3	50	6								
1STE 000 1200 S06	0	120°	1.73	50	6								
1STE 0005 200 S04	0.05	20°	5	40	4								
1STE 0005 300 S04	0.05	30°	5	40	4								
1STE 0005 900 S04	0.05	90°	1.97	40	4								
1STE 0005 200 S06	0.05	20°	5	50	6								
1STE 0005 300 S06	0.05	30°	5	50	6								
1STE 0005 900 S06	0.05	90°	2.97	50	6								
1STE 0005 1200 S06	0.05	120°	1.71	50	6								
1STE 001 200 S04	0.1	20°	5	40	4								
1STE 001 300 S04	0.1	30°	5	40	4								
1STE 001 600 S04	0.1	60°	3.37	40	4								
1STE 001 900 S04	0.1	90°	1.95	40	4								
1STE 001 200 S06	0.1	20°	5	50	6								
1STE 001 300 S06	0.1	30°	5	50	6								
1STE 001 900 S06	0.1	90°	2.95	50	6								
1STE 001 1200 S06	0.1	120°	1.7	50	6								
1STE 0015 200 S04	0.15	20°	5	40	4								
1STE 0015 300 S04	0.15	30°	5	40	4								
1STE 0015 600 S04	0.15	60°	3.33	40	4								
1STE 0015 900 S04	0.15	90°	1.92	40	4								
1STE 0015 200 S06	0.15	20°	5	50	6								
1STE 0015 300 S06	0.15	30°	5	50	6								
1STE 0015 900 S06	0.15	90°	2.92	50	6								
1STE 0015 1200 S06	0.15	120°	1.68	50	6								
1STE 002 200 S04	0.2	20°	5	40	4								
1STE 002 300 S04	0.2	30°	5	40	4								
1STE 002 600 S04	0.2	60°	3.29	40	4								
1STE 002 900 S04	0.2	90°	1.9	40	4								
1STE 002 200 S06	0.2	20°	5	50	6								
1STE 002 300 S06	0.2	30°	5	50	6								
1STE 002 900 S06	0.2	90°	2.9	50	6								
1STE 002 1200 S06	0.2	120°	1.67	50	6								

GENERAL PURPOSE

#### 가공형상에따른절삭가능여부 Available Cutting Shape

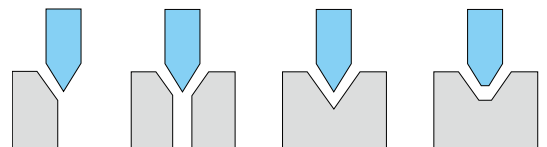

가능 (O)



# 2STE 2 Flutes Straight Flute Taper End Mills

## 2날 직선 날 테이퍼 엔드밀

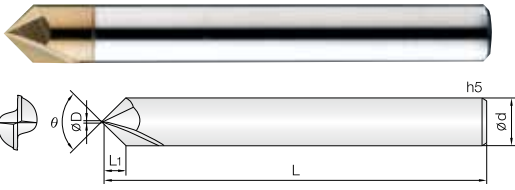

- HRC50이하의 고경도강, 프리하든강, 공구강, 주철 등 피삭재 가공
- 실리콘계 코팅(Si)처리하여 내마모성이 우수합니다.
- 직선날 타입 2날을 적용하여 조각NC 작업, 피삭재 모서리 면취, 센터링 작업에 적합합니다.
- 코팅과 비코팅으로 구분하여 수지, 아크릴 등의 가공도 가능합니다.

- Endmills for various work materials, hardened steels(HRc~50), pre-hardened steels, tool steels and cast irons
- Good wear resistance by Si-based PVD coating.
- Optimum for NC engraving, chamfering and centering with straight 2flutes.
- Resin, plastic machining applicable with coated or non coated endmill.



495P

D Size	D Tolerance
∅0	+0.05 ~ -0mm

단위 : mm

Order Number		날경 Diameter D	각도 Angle θ	날장 Length of cut L1	전장 Overall Length L	샙크 Shank Dia d	비고	
비코팅 Un coated	코팅 Coated						비코팅 Un coated	코팅 Coated
2STE 000 300 S03	2STEC 000 300 S03	0	30°	5.5	60	3		
2STE 000 600 S03	2STEC 000 600 S03	0	60°	2.5	60	3		
2STE 000 900 S03	2STEC 000 900 S03	0	90°	1.5	60	3		
	2STEC 000 900 080	0	90°	1.5	80	3		
2STE 000 1200 S03	2STEC 000 1200 S03	0	120°	0.86	60	3		
2STE 000 300 S04	2STEC 000 300 S04	0	30°	7.4	60	4		
2STE 000 600 S04	2STEC 000 600 S04	0	60°	3.4	60	4		
2STE 000 900 S04	2STEC 000 900 S04	0	90°	2	60	4		
	2STEC 000 900 100	0	90°	2	100	4		
2STE 000 1200 S04	2STEC 000 1200 S04	0	120°	1.15	60	4		
2STE 000 300 S06	2STEC 000 300 S06	0	30°	11.1	60	6		
2STE 000 600 S06	2STEC 000 600 S06	0	60°	5.1	60	6		
2STE 000 900 S06	2STEC 000 900 S06	0	90°	3	60	6		
	2STEC 000 900 110	0	90°	3	110	6		
2STE 000 1200 S06	2STEC 0001200 S06	0	120°	1.73	60	6		
2STE 000 600 S08	2STEC 000 600 S08	0	60°	6.9	65	8		
2STE 000 900 S08	2STEC 000 900 S08	0	90°	4	65	8		
	2STEC 000 900 120	0	90°	4	120	8		
2STE 000 1200 S08	2STEC 000 1200 S08	0	120°	2.3	65	8		
2STE 000 600 S10	2STEC 000 600 S10	0	60°	8.6	70	10		
2STE 000 900 S10	2STEC 000 900 S10	0	90°	5	70	10		
	2STEC 000 900 150	0	90°	5	150	10		
2STE 000 1200 S10	2STEC 000 1200 S10	0	120°	2.88	70	10		
2STE 000 600 S12	2STEC 000 600 S12	0	60°	10.3	75	12		
2STE 000 900 S12	2STEC 000 900 S12	0	90°	6	75	12		
	2STEC 000 900 160	0	90°	6	160	12		
2STE 000 1200 S12	2STEC 000 1200 S12	0	120°	3.46	75	12		

GENERAL PURPOSE

### 가공형상에따른절삭가능여부 Available Cutting Shape

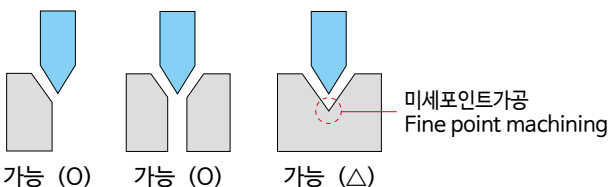

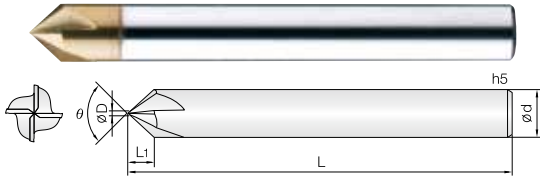

- HRC52이하의 고경도강, 프리하드강, 공구강, 주철 등 피삭재 가공
- 실리콘계 코팅 (Si) 처리하여 내마모성이 우수합니다.
- 직선날 타입 4날을 적용하여 조각NC 작업, 피삭재 모서리 면취, 센터링 작업에 최고의 성능을 발휘합니다.
- 항질력이 높은 미립자 초경합금을 채택, 고이송 작업시 엔드밀의 파손을 최소화 하였습니다.

- Endmills for various work materials, hardened steels (HRC~50), pre-hardened steels, tool steels and cast irons
- Good wear resistance by Si-based PVD coating.
- Optimum for NC engraving, chamfering and centering with straight 4flutes.
- Minimize fracturing at high feed by high TRS fine WC grade.



495P

D Size	D Tolerance
ø0	+0.05 ~ -0mm

단위: mm

Order Number	날경 Diameter D	각도 Angle θ	날장 Length of cut L1	전장 Overall Length L	생크 Shank Dia d	비고	Order Number	날경 Diameter D	각도 Angle θ	날장 Length of cut L1	전장 Overall Length L	생크 Shank Dia d	비고
4STE 000 600 S03	0	60°	2.5	50	3								
4STE 000 900 S03	0	90°	1.5	50	3								
4STE 000 600 S04	0	60°	3.4	50	4								
4STE 000 900 S04	0	90°	2	50	4								
4STE 000 600 S06	0	60°	5.1	60	6								
4STE 000 900 S06	0	90°	3	60	6								
4STE 000 900 030	0	90°	3	100	6								
4STE 000 600 S08	0	60°	6.9	65	8								
4STE 000 900 S08	0	90°	4	65	8								
4STE 000 900 040	0	90°	4	100	8								
4STE 000 600 S10	0	60°	8.6	75	10								
4STE 000 900 S10	0	90°	5	75	10								
4STE 000 900 050	0	90°	5	100	10								
4STE 000 600 S12	0	60°	10.3	80	12								
4STE 000 900 S12	0	90°	6	80	12								
4STE 000 900 080	0	90°	8	100	16								

GENERAL PURPOSE

#### 가공형상에따른절삭가능여부 Available Cutting Shape

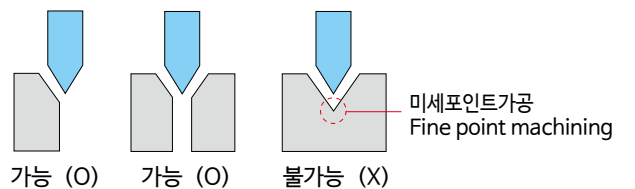

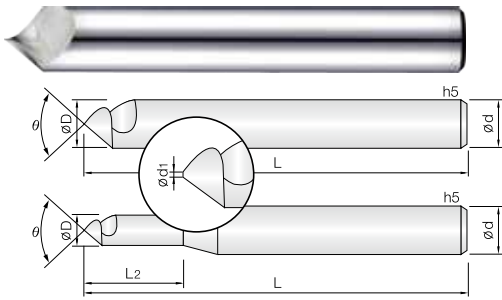

- 알루미늄 합금, 동합금, 플라스틱 등 연질 피삭재 가공
- 뛰어난 표면 조도와 버를 최소화 합니다.
- 헬릭스 타입 1날 적용하여 공구 센터의 결삭력이 뛰어납니다.
- 하나의 공구로 모든 면취가 가능하며 우수한 성능을 발휘합니다.

- Processing of soft cutting materials such as aluminum alloys, brass alloys, and plastics
- Achieves excellent surface finish and minimizes burrs.
- Applying single-flute helix type ensures outstanding cutting force at the tool center.
- Capable of all chamfering with a single tool and demonstrates excellent performance.



D Size	D Tolerance	d1 Size	d1 Tolerance
Ø 0.9 ~ 6	+0 ~ -0.01mm	Ø 0.3 ~ 4	+0 ~ -0.02mm
Ø 8 ~ 16	+0 ~ -0.015mm		

494P

단위 : mm

Order Number		날경	선단경	각도	날장	유효장	전장	샙크	비고
		Diameter	Neck Diameter	Angle	Length of cut	Effective Length	Overall Length	Shank Dia	
비코팅 Un coated	RTAC 코팅 RTAC Coated	D	d1	θ	L1	L2	L	d	
1CHA 009 900 S03	1CHAC 009 900 S03	0.9	0.3	90°	0.3	2.7	40	3	
1CHA 012 900 S03	1CHAC 012 900 S03	1.2	0.4	90°	0.4	3.6	40	3	
1CHA 020 900 S03	1CHAC 020 900 S03	2	0.6	90°	0.7	6	40	3	
1CHA 030 900 S03	1CHAC 030 900 S03	3	0.8	90°	1.1	-	40	3	
1CHA 040 900 S04	1CHAC 040 900 S04	4	1	90°	1.5	-	40	4	
1CHA 060 900 S06	1CHAC 060 900 S06	6	1.5	90°	2.25	-	50	6	
1CHA 080 900 S08	1CHAC 080 900 S08	8	2	90°	3	-	60	8	
1CHA 100 900 S10	1CHAC 100 900 S10	10	2.5	90°	3.75	-	70	10	
1CHA 120 900 S12	1CHAC 120 900 S12	12	3	90°	4.5	-	75	12	
1CHA 160 900 S16	1CHAC 160 900 S16	16	4	90°	6	-	80	16	

### 가공형상에 따른 절삭가능여부 Available Cutting Shape

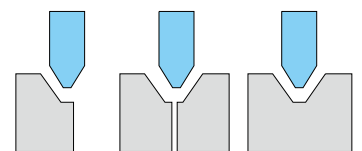

가능 (O)

GENERAL PURPOSE

# 2CHA 2 Flutes 90° Chamfering Cutters

## 2날 90°면취 커터

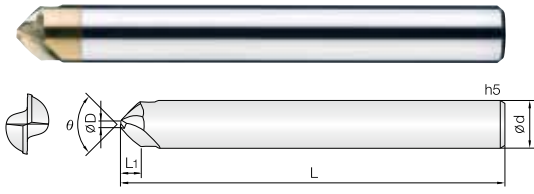

- HRC50이하의 고경도강, 프리하든강, 공구강, 주철 등 피삭재 가공
- 실리콘계 코팅 (Si) 처리하여 내마모성이 우수합니다.
- 헬릭스 타입 2날을 적용하여 모서리 면취 가공시 절삭력이 좋으며, 피삭재의 조도가 우수합니다.
- 항절력이 높은 미립자 초경합금을 채택, 고이송 작업시 엔드밀의 파손을 최소화 하였습니다.
- Endmills for various work materials, hardened steels (HRC~50), pre-hardened steels, tool steels and cast irons
- Good wear resistance by Si-based PVD coating.
- Applied helix 2flutes design for better performance in corner chamfering.
- Minimize fracturing at high feed by high TRS fine WC grade.



495P

D Size	D Tolerance
Ø 0.8 ~ 1	+0 ~ -0.02mm

단위 : mm

Order Number	날경 Diameter D	각도 Angle θ	날장 Length of cut L1	전장 Overall Length L	샙크 Shank Dia d	비고	Order Number	날경 Diameter D	각도 Angle θ	날장 Length of cut L1	전장 Overall Length L	샙크 Shank Dia d	비고
2CHA 008 900 011	0.8	90°	1.1	50	3								
2CHA 008 900 016	0.8	90°	1.6	50	4								
2CHA 010 900 025	1	90°	2.5	60	6								
2CHA 010 900 035	1	90°	3.5	70	8								
2CHA 010 900 045	1	90°	4.5	80	10								
2CHA 010 900 055	1	90°	5.5	90	12								

# 3CHA 3 Flutes 90° Chamfering Cutters

## 3날 90°면취 커터

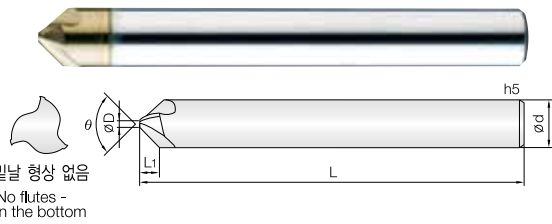

밀날 형상 없음  
No flutes -  
in the bottom

- HRC50이하의 고경도강, 프리하든강, 공구강, 주철 등 피삭재 가공
- 실리콘계 코팅 (Si) 처리하여 내마모성이 우수합니다.
- 헬릭스 타입 3날을 적용하여 모서리 면취 가공시 절삭력이 좋으며, 피삭재의 조도가 우수합니다.
- 항절력이 높은 미립자 초경합금을 채택, 고이송 작업시 엔드밀의 파손을 최소화 하였습니다.
- Endmills for various work materials, hardened steels (HRC ~50), pre-hardened steels, tool steels and cast irons
- Good wear resistance by Si-based PVD coating.
- Applied helix 3flutes design for better performance in corner chamfering.
- Minimize fracturing at high feed by high TRS fine WC grade.



495P

D Size	D Tolerance
Ø 0.8 ~ 2	+0 ~ -0.02mm

단위 : mm

Order Number	날경 Diameter D	각도 Angle θ	날장 Length of cut L1	전장 Overall Length L	샙크 Shank Dia d	비고	Order Number	날경 Diameter D	각도 Angle θ	날장 Length of cut L1	전장 Overall Length L	샙크 Shank Dia d	비고
3CHA 008 900 011	0.8	90°	1.1	50	3								
3CHA 008 900 016	0.8	90°	1.6	50	4								
3CHA 010 900 025	1	90°	2.5	60	6								
3CHA 010 900 035	1	90°	3.5	65	8								
3CHA 020 900 040	2	90°	4.0	75	10								
3CHA 020 900 050	2	90°	5.0	80	12								

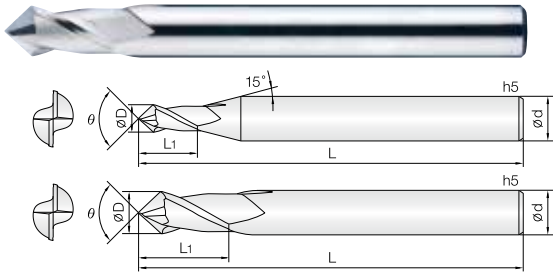

- 비코팅 : 아크릴, ABS, 알루미늄 등 비철, 비금속 피삭재 가공
- 코팅 : 프리하든강, 일반강, 주물 비철합금 가공엔드밀
- 센터링 작업 및 모서리 면취와 측면절삭을 동시에 할 수 있는 다가용 엔드밀.
- 미립자 초경합금을 채택, 다양한 비철합금과 목업의 피삭재에 적용 가능합니다.
- JCRO 코팅과 비코팅을 구분하여 HRC50이하의 고경도강, 프리하든강, 주철 등 다양한 피삭재 가공이 가능합니다.

- Non coating : acryl, A.B.S, aluminum, non-ferrous and non-metallic materials
- Coating : pre-hardened steels, cast irons, non-metallic materials
- Multi function endmill for corner chamfering, side wall and centering.
- Applied fine WC grade optimized for various non-ferrous and nonmetallic work materials.
- Endmills for various work materials, hardened steel (HRC ~ 50), pre-hardened steel, tool steel and cast iron.



497P

Condition	D Size	D Tolerance	Condition	D Size	D Tolerance
ØD ≠ Ød	Ø0.2 ~ 6	+0 ~ -0.01mm	ØD = Ød	Ø3 ~ 6	-0.005 ~ -0.015mm
	Ø8 ~ 16	+0 ~ -0.015mm		Ø8 ~ 12	-0.01 ~ -0.025mm
				Ø14 ~ 16	-0.015 ~ -0.03mm

단위 : mm

Order Number		날경 Diameter D	각도 Angle θ	날장 Length of cut L1	전장 Overall Length L	샹크 Shank Dia d	비고	
비코팅 Un coated	코팅 Coated						비코팅 Un coated	코팅 Coated
2CEN 002 600 S03	2CENC 002 600 S03	0.2	60°	0.4	40	3		
2CEN 002 900 S03	2CENC 002 900 S03	0.2	90°	0.4	40	3		
2CEN 003 600 S03	2CENC 003 600 S03	0.3	60°	0.6	45	3		
2CEN 003 900 S03	2CENC 003 900 S03	0.3	90°	0.6	45	3		
2CEN 005 600 S03	2CENC 005 600 S03	0.5	60°	1	50	3		
2CEN 005 900 S03	2CENC 005 900 S03	0.5	90°	1	50	3		
2CEN 008 600 S03	2CENC 008 600 S03	0.8	60°	1.6	50	3		
2CEN 008 900 S03	2CENC 008 900 S03	0.8	90°	1.6	50	3		
2CEN 010 600 S03	2CENC 010 600 S03	1	60°	2	50	3		
2CEN 010 900 S03	2CENC 010 900 S03	1	90°	2	50	3		
2CEN 015 600 S03	2CENC 015 600 S03	1.5	60°	3	50	3		
2CEN 015 900 S03	2CENC 015 900 S03	1.5	90°	3	50	3		
2CEN 020 600 S03	2CENC 020 600 S03	2	60°	4	50	3		
2CEN 020 900 S03	2CENC 020 900 S03	2	90°	4	50	3		
2CEN 030 600 S03	2CENC 030 600 S03	3	60°	6	50	3		
2CEN 030 900 S03	2CENC 030 900 S03	3	90°	6	50	3		
2CEN 030 600 S06	2CENC 030 600 S06	3	60°	6	50	6		
2CEN 030 900 S06	2CENC 030 900 S06	3	90°	6	50	6		
2CEN 040 600 S06	2CENC 040 600 S06	4	60°	8	50	6		
2CEN 040 900 S06	2CENC 040 900 S06	4	90°	8	50	6		
2CEN 050 600 S06	2CENC 050 600 S06	5	60°	10	50	6		
2CEN 050 900 S06	2CENC 050 900 S06	5	90°	10	50	6		
2CEN 060 600 S06	2CENC 060 600 S06	6	60°	12	60	6		
2CEN 060 900 S06	2CENC 060 900 S06	6	90°	12	60	6		
2CEN 080 600 S08	2CENC 080 600 S08	8	60°	16	70	8		
2CEN 080 900 S08	2CENC 080 900 S08	8	90°	16	70	8		
2CEN 100 600 S10	2CENC 100 600 S10	10	60°	18	70	10		
2CEN 100 900 S10	2CENC 100 900 S10	10	90°	18	70	10		
2CEN 120 600 S12	2CENC 120 600 S12	12	60°	20	75	12		
2CEN 120 900 S12	2CENC 120 900 S12	12	90°	20	75	12		
2CEN 140 600 S14	2CENC 140 600 S14	14	60°	26	80	14		
2CEN 140 900 S14	2CENC 140 900 S14	14	90°	26	80	14		
2CEN 160 600 S16	2CENC 160 600 S16	16	60°	32	100	16		
2CEN 160 900 S16	2CENC 160 900 S16	16	90°	32	100	16		

GENERAL PURPOSE

#### 가공형상에따른절삭가능여부 Available Cutting Shape

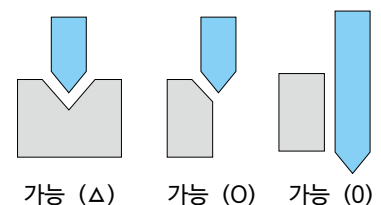

가능 (Δ)

가능 (O)

가능 (O)

## 2날 소경면취 엔드밀

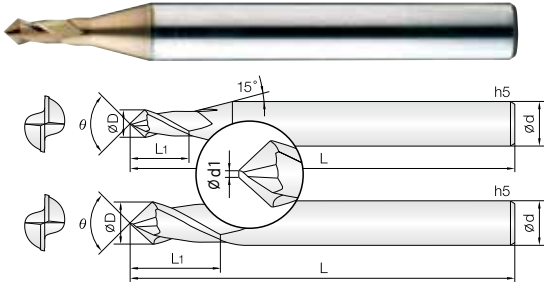

- 프리하든강, 일반강, 주물 비철합금 가공 엔드밀
- 센터링 작업 및 모서리 면취와 측면절삭을 동시에 가공할 수 있는 다기능 엔드밀입니다.
- 미립자 초경합금을 채택, 다양한 비철합금과 목업의 피삭재에 적용 가능합니다.
- JCRO 코팅을 적용하여 HRC50이하의 고경도강, 프리하든강, 주철 등 다양한 피삭재 가공이 가능합니다.
- **Pre-hardened steels, Cast irons, Non-metallic materials**
- Multi function endmill for corner chamfering, side wall and centering.
- Applied fine WC grade optimized for various non-ferrous and non-metallic work materials.
- Endmills for various work materials, hardened steel (HRC ~50), pre-hardened steel, tool steel and cast iron.

2
WC 미립자
JCRO Coating
30° Helix Angle
CUTTING DATA

497P

Condition	D Size	D Tolerance		
φD ≠ φd	φ0.5 ~ 3	+0 ~ -0.01mm		

  

Condition	D Size	D Tolerance	d1 Size	d1 Tolerance
φD = φd	φ3	-0.005 ~ -0.015mm	φ0.05 ~ 0.2	+0 ~ -0.01mm

단위 : mm

Order Number	날경 Diameter D	선단경 Neck Diameter φd1	각도 Angle θ	날장 Length of cut L1	전장 Overall Length L	샹크 Shank Dia d	비고
2CENE 005 0005 090	0.5	0.05	90°	1	40	3	
2CENE 006 0005 090	0.6	0.05	90°	1.2	40	3	
2CENE 007 0005 090	0.7	0.05	90°	1.4	40	3	
2CENE 008 0005 090	0.8	0.05	90°	1.6	40	3	
2CENE 010 0005 090	1	0.05	90°	2	40	3	
2CENE 010 001 090	1	0.1	90°	2	40	3	
2CENE 010 001 120	1	0.1	120°	2	40	3	
2CENE 012 001 090	1.2	0.1	90°	2.4	40	3	
2CENE 015 001 090	1.5	0.1	90°	3	40	3	
2CENE 015 001 120	1.5	0.1	120°	3	40	3	
2CENE 020 001 090	2	0.1	90°	4	40	3	
2CENE 020 002 090	2	0.2	90°	4	40	3	
2CENE 020 002 120	2	0.2	120°	4	40	3	
2CENE 025 002 090	2.5	0.2	90°	5	40	3	
2CENE 030 002 090	3	0.2	90°	6	40	3	
2CENE 030 002 120	3	0.2	120°	6	40	3	

**가공형상에따른절삭가능여부**  
Available Cutting Shape

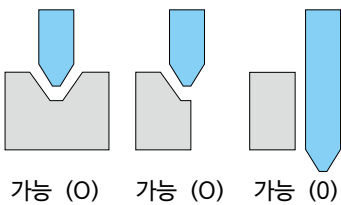

GENERAL PURPOSE

## 2날 코너45도 면취 엔드밀

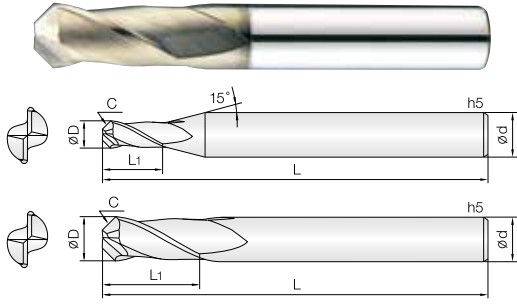

- 프리하드강, 일반강, 주물 비철합금 가공 엔드밀
- 모서리 면취와 측면절삭을 동시에 가공할 수 있는 다기능 엔드밀입니다.
- 엔드밀의 인선을 면취설계하여 엔드밀의 치핑을 최소화 하였습니다.
- JCRO코팅 처리하여 다양한 피삭재 가공시 인선부에 스트레스가 적으며, 내마모성 또한 향상됩니다.
- 다양한 피삭재 가공이 가능합니다.

• Pre-hardened steels, Cast iron, Non-metallic materials

- Multi function endmill for corner chamfering, side wall.
- Minimize edge chipping by applying edge chamfering design.
- JCRO coating provides wear resistance improvement as well as avoid edge stress in various applications.
- Endmills for various work materials.



497P

Condition	D Size	D Tolerance	Condition	D Size	D Tolerance
øD ≠ ød	ø1 ~ 6	+0 ~ -0.01mm	øD = ød	ø6	-0.005 ~ -0.015mm
	ø8 ~ 12	+0 ~ -0.015mm		ø8 ~ 12	-0.01 ~ -0.025mm

단위 : mm

Order Number	날경 Diameter D	면취량 Chamfer C	날장 Length of cut L1	전장 Overall Length L	샤프크 Shank Dia d	비고	Order Number	날경 Diameter D	면취량 Chamfer C	날장 Length of cut L1	전장 Overall Length L	샤프크 Shank Dia d	비고
2CCMC 010 0002 S04	1	0.02	2.5	45	4		2CCMC 080 025 S08	8	2.5	19	70	8	
2CCMC 010 0005 S04	1	0.05	2.5	45	4		2CCMC 080 030 S08	8	3	19	70	8	
2CCMC 010 001 S04	1	0.1	2.5	45	4		2CCMC 100 001 S10	10	0.1	22	75	10	
2CCMC 010 002 S04	1	0.2	2.5	45	4		2CCMC 100 002 S10	10	0.2	22	75	10	
2CCMC 010 003 S04	1	0.3	2.5	45	4		2CCMC 100 005 S10	10	0.5	22	75	10	
2CCMC 015 0005 S04	1.5	0.05	4	45	4		2CCMC 100 010 S10	10	1	22	75	10	
2CCMC 015 001 S04	1.5	0.1	4	45	4		2CCMC 100 015 S10	10	1.5	22	75	10	
2CCMC 015 002 S04	1.5	0.2	4	45	4		2CCMC 100 020 S10	10	2	22	75	10	
2CCMC 015 003 S04	1.5	0.3	4	45	4		2CCMC 100 030 S10	10	3	22	75	10	
2CCMC 015 005 S04	1.5	0.5	4	45	4		2CCMC 100 040 S10	10	4	22	75	10	
2CCMC 020 0005 S04	2	0.05	6	45	4		2CCMC 120 001 S12	12	0.1	26	80	12	
2CCMC 020 001 S04	2	0.1	6	45	4		2CCMC 120 002 S12	12	0.2	26	80	12	
2CCMC 020 002 S04	2	0.2	6	45	4		2CCMC 120 005 S12	12	0.5	26	80	12	
2CCMC 020 003 S04	2	0.3	6	45	4		2CCMC 120 010 S12	12	1	26	80	12	
2CCMC 020 004 S04	2	0.4	6	45	4		2CCMC 120 015 S12	12	1.5	26	80	12	
2CCMC 020 005 S04	2	0.5	6	45	4		2CCMC 120 020 S12	12	2	26	80	12	
2CCMC 030 0005 S06	3	0.05	8	50	6		2CCMC 120 030 S12	12	3	26	80	12	
2CCMC 030 001 S06	3	0.1	8	50	6		2CCMC 120 040 S12	12	4	26	80	12	
2CCMC 030 002 S06	3	0.2	8	50	6		2CCMC 120 050 S12	12	5	26	80	12	
2CCMC 030 003 S06	3	0.3	8	50	6								
2CCMC 030 005 S06	3	0.5	8	50	6								
2CCMC 030 010 S06	3	1	8	50	6								
2CCMC 040 0005 S06	4	0.05	11	50	6								
2CCMC 040 001 S06	4	0.1	11	50	6								
2CCMC 040 002 S06	4	0.2	11	50	6								
2CCMC 040 003 S06	4	0.3	11	50	6								
2CCMC 040 005 S06	4	0.5	11	50	6								
2CCMC 040 010 S06	4	1	11	50	6								
2CCMC 040 015 S06	4	1.5	11	50	6								
2CCMC 050 001 S06	5	0.1	13	60	6								
2CCMC 050 002 S06	5	0.2	13	60	6								
2CCMC 050 005 S06	5	0.5	13	60	6								
2CCMC 050 010 S06	5	1	13	60	6								
2CCMC 050 015 S06	5	1.5	13	60	6								
2CCMC 050 020 S06	5	2	13	60	6								
2CCMC 060 0005 S06	6	0.05	13	60	6								
2CCMC 060 001 S06	6	0.1	13	60	6								
2CCMC 060 002 S06	6	0.2	13	60	6								
2CCMC 060 003 S06	6	0.3	13	60	6								
2CCMC 060 005 S06	6	0.5	13	60	6								
2CCMC 060 010 S06	6	1	13	60	6								
2CCMC 060 015 S06	6	1.5	13	60	6								
2CCMC 060 020 S06	6	2	13	60	6								
2CCMC 060 025 S06	6	2.5	13	60	6								
2CCMC 080 001 S08	8	0.1	19	70	8								
2CCMC 080 002 S08	8	0.2	19	70	8								
2CCMC 080 005 S08	8	0.5	19	70	8								
2CCMC 080 010 S08	8	1	19	70	8								
2CCMC 080 015 S08	8	1.5	19	70	8								
2CCMC 080 020 S08	8	2	19	70	8								

GENERAL PURPOSE

# 4TES 4 Flutes T-Slot Cutters

## 4날 T 커터

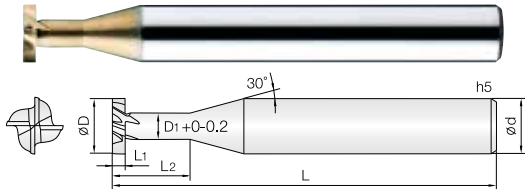

- HRC50이하의 고경도강, 프리하드강, 공구강, 주철 등 피삭재 가공
  - JCRO코팅 처리하여 다양한 피삭재 가공시 인선부에 스트레스가 적으며, 내마모성 또한 향상됩니다.
  - 4날을 적용하여 인선부 치핑을 최소화 하였습니다.
  - 다양한 형상과 유효장으로 공작물 간섭을 최소화하여 작업효율이 향상됩니다.
  - 코팅과 비코팅으로 구분하여 수지, 아크릴 등의 가공도 가능합니다.
- Endmills for various work materials, hardened steels(HRc~50), pre-hardened steels, tool steels and cast irons
  - JCRO coating provides wear resistance improvement as well as avoid edge stress in various applications.
  - Minimize edge chipping by applying 4flutes design.
  - Various shapes and length provides optimum efficiency.
  - Resin, plastic machining applicable with coated or non coated endmill.

ø2 ~ ø5     ø6 ~ ø10     496P

D Size	D Tolerance
ø 2 ~ 5	+0 ~ -0.02mm
ø 6 ~ 10	-0.01 ~ -0.03mm

단위 : mm

Order Number		날경	날장	유효장	목부경	전장	샤프트	비고	
비코팅 Un coated	코팅 Coated	Diameter D	Length of Cut L1	Effective Length L2	Neck Diameter D1	Overall Length L	Shank Dia d	비코팅 Un coated	코팅 Coated
4TES 020 003 040	4TESC 020 003 040	2	0.3	4	1	50	6		
4TES 020 005 040	4TESC 020 005 040	2	0.5	4	1	50	6		
4TES 030 003 045	4TESC 030 003 045	3	0.3	4.5	1.5	50	6		
4TES 030 005 045	4TESC 030 005 045	3	0.5	4.5	1.5	50	6		
4TES 030 010 045	4TESC 030 010 045	3	1	4.5	1.5	50	6		
4TES 040 003 050	4TESC 040 003 050	4	0.3	5	2	50	6		
4TES 040 005 050	4TESC 040 005 050	4	0.5	5	2	50	6		
4TES 040 010 050	4TESC 040 010 050	4	1	5	2	50	6		
4TES 050 005 045	4TESC 050 005 045	5	0.5	4.5	2.5	50	6		
4TES 050 010 050	4TESC 050 010 050	5	1	5	2.5	50	6		
4TES 050 015 055	4TESC 050 015 055	5	1.5	5.5	2.5	50	6		
4TES 050 020 060	4TESC 050 020 060	5	2	6	2.5	50	6		
4TES 060 005 045	4TESC 060 005 045	6	0.5	4.5	3	60	6		
4TES 060 010 050	4TESC 060 010 050	6	1	5	3	60	6		
4TES 060 015 055	4TESC 060 015 055	6	1.5	5.5	3	60	6		
4TES 060 020 060	4TESC 060 020 060	6	2	6	3	60	6		
4TES 080 005 045	4TESC 080 005 045	8	0.5	4.5	4	60	8		
4TES 080 010 050	4TESC 080 010 050	8	1	5	4	60	8		
4TES 080 015 055	4TESC 080 015 055	8	1.5	5.5	4	60	8		
4TES 080 020 060	4TESC 080 020 060	8	2	6	4	60	8		
4TES 080 030 070	4TESC 080 030 070	8	3	7	4	60	8		
4TES 100 010 070	4TESC 100 010 070	10	1	7	5	70	10		
4TES 100 020 080	4TESC 100 020 080	10	2	8	5	70	10		
4TES 100 030 090	4TESC 100 030 090	10	3	9	5	70	10		

GENERAL PURPOSE



# 4TRS 4 Flutes T-R Slot Cutters

## 4날 T-R 커터

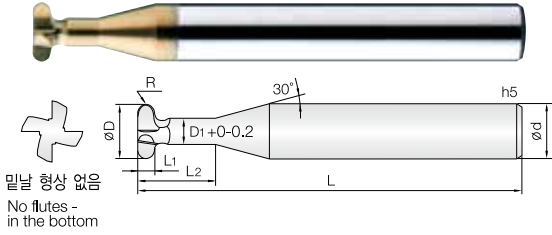

- HRC50이하의 고경도강, 프리하든강, 공구강, 주철 등 피삭재 가공
- JCRO코팅 처리하여 다양한 피삭재 가공시 인선부에 스트레스가 적으며, 내마모성 또한 향상됩니다.
- 직선날 타입 4날을 적용하여 인선부 칩핑을 최소화 하였습니다.
- 다양한 형상과 유효장으로 공작물 간섭을 최소화하여 작업효율이 향상됩니다.

- Endmills for various work materials, hardened steels(HRc~50), pre-hardened steels, tool steels and cast irons
- JCRO coating provides wear resistance improvement as well as avoid edge stress in various applications.
- Minimize edge chipping by applying straight 4flutes design.
- Various shapes and length provides optimum efficiency.

4

WC  
미립자

JCRO  
Coating

R  
± 0.02

L1  
± 0.03

L1  
± 0.05

0°  
Helix Angle

CUTTING  
DATA

0.25R ~ 3R    ø4 ~ 5    ø6 ~ 12    496P

D Size	D Tolerance
ø4	+0 ~ -0.02mm
ø5 ~ 12	-0.01 ~ -0.025mm

단위 : mm

Order Number	날경 Diameter D × R	날장 Length of cut L1	유효장 Effective Length L2	목부경 Neck Diameter D1	전장 Overall Length L	샤프트 Shank Dia d	비고
New 4TRS 040 005 040	4 X 0.25R	0.5	4	2	50	6	
New 4TRS 040 010 040	4 X 0.5R	1	4	2	50	6	
4TRS 050 010 045	5 X 0.5R	1	4.5	2.5	50	6	
4TRS 050 010 070	5 X 0.5R	1	7	2.5	50	6	
4TRS 050 020 055	5 X 1R	2	5.5	2.5	50	6	
4TRS 060 010 050	6 X 0.5R	1	5	3	50	6	
4TRS 060 010 080	6 X 0.5R	1	8	3	50	6	
4TRS 060 015 055	6 X 0.75R	1.5	5.5	3	50	6	
4TRS 060 020 060	6 X 1R	2	6	3	50	6	
4TRS 060 020 100	6 X 1R	2	10	3	50	6	
New 4TRS 080 010 070	8 X 0.5R	1	7	4	60	8	
New 4TRS 080 010 130	8 X 0.5R	1	13	4	60	8	
4TRS 080 020 070	8 X 1R	2	7	4	60	8	
4TRS 080 020 130	8 X 1R	2	13	4	60	8	
4TRS 080 030 080	8 X 1.5R	3	8	4	60	8	
New 4TRS 100 030 100	10 X 1.5R	3	10	4.5	70	10	
New 4TRS 100 030 160	10 X 1.5R	3	16	4.5	70	10	
4TRS 100 040 100	10 X 2R	4	10	4.5	70	10	
4TRS 100 040 160	10 X 2R	4	16	4.5	70	10	
New 4TRS 120 030 150	12 X 1.5R	3	15	5	75	12	
New 4TRS 120 030 210	12 X 1.5R	3	21	5	75	12	
New 4TRS 120 040 150	12 X 2R	4	15	5	75	12	
New 4TRS 120 040 210	12 X 2R	4	21	5	75	12	
4TRS 120 060 150	12 X 3R	6	15	5	75	12	
4TRS 120 060 210	12 X 3R	6	21	5	75	12	

GENERAL PURPOSE

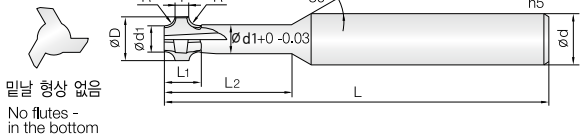

- HRC50이하의 고경도강, 프리하든강, 공구강, 주철 등 피삭재 가공
- JCRO코팅 처리하여 다양한 피삭재 가공시 인선부에 스트레스가 적으며, 내마모성 또한 향상됩니다.
- 직선날 타입 3날을 적용하여 인선부 칩핑을 최소화 하였습니다.
- 다양한 형상과 유효장으로 공작물 간섭을 최소화하여 작업효율이 향상됩니다.
- Endmills for various work materials, hardened steels (HRC~50), pre-hardened steels, tool steels and cast irons
- JCRO coating provides wear resistance improvement as well as avoid edge stress in various applications.
- Minimize edge chipping by applying straight 3flutes design.
- Various shapes and length provides optimum efficiency.



0.2R ~ 3R

496P

D Size	D Tolerance	d1 Size	d1 Tolerance
Ø 1.9 ~ 11.9	+0 ~ -0.03mm	Ø 1.45 ~ 5.8	+0 ~ -0.02mm

단위 : mm

Order Number	날경 Diameter D × R	선단경 Front Diameter Ø d1	두께 Thickness T	날장 Length of cut L1	유효장 Effective Length L2	전장 Overall Length L	생크 Shank Dia d	비고
3TRC 019 002 080	1.9 X R0.2	1.45	0.9	1.45	8	60	4	
3TRC 024 003 090	2.4 X R0.3	1.75	1.2	1.95	9	60	4	
3TRC 026 004 100	2.6 X R0.4	1.75	1.5	2.5	10	60	4	
3TRC 029 005 120	2.9 X R0.5	1.85	1.8	3	12	60	4	
3TRC 049 005 150	4.9 X R0.5	3.8	2	3.3	15	80	6	
3TRC 068 010 200	6.8 X R1	4.7	2.2	4.3	20	80	8	
3TRC 079 015 250	7.9 X R1.5	4.7	2.5	5.8	25	80	8	
3TRC 099 020 300	9.9 X R2	5.8	2.8	6.8	30	80	10	
3TRC 119 030 350	11.9 X R3	5.8	3	8.8	35	80	12	

GENERAL PURPOSE

#### 가공형상에따른절삭가능여부 Available Cutting Shape

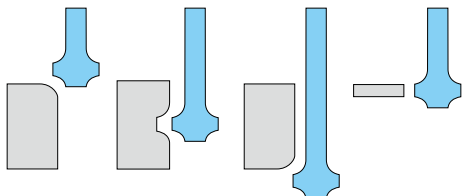

가능 (O)    가능 (O)    가능 (O)    가능 (O)

# 4&6TDA 4 & 6 Flutes T-Double Angular Cutters

## 4&6날 T-더블 앵글 커터

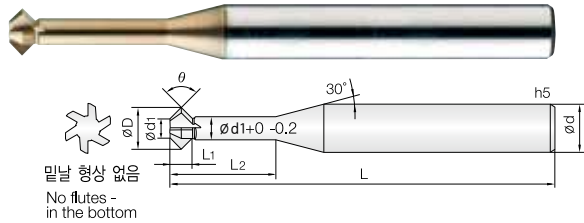

- HRC50이하의 고경도강, 프리하든강, 공구강, 주철 등 피삭재 가공
- JCRO코팅 처리하여 다양한 피삭재 가공시 인선부에 스트레스가 적으며, 내마모성 또한 향상됩니다.
- 직선날 타입 4날을 적용하여 인선부 칩핑을 최소화 하였습니다.
- 다양한 형상과 유효장으로 공작물 간섭을 최소화하여 작업효율이 향상됩니다.

- Endmills for various work materials, hardened steels(HRc~50), pre-hardened steels, tool steels and cast irons
- JCRO coating provides wear resistance improvement as well as avoid edge stress in various applications.
- Minimize edge chipping by applying straight 4flutes design.
- Various shapes and length provides optimum efficiency.



D Size	D Tolerance	d1 Size	d1 Tolerance
Ø 1.5 ~ 5	+0 ~ -0.02mm	Ø 0.75 ~ 6	+0 ~ -0.02mm
Ø 6 ~ 12	-0.01 ~ -0.03mm		

Order Number	날경 Diameter D	각도 Angle θ	날장 Length of cut L1	유효장 Effective Length L2	선단경 Neck Diameter Ød1	전장 Overall Length L	샹크 Shank Dia d	비고
4TDA 015 600 030	1.5	60°	0.43	3	0.75	45	4	
4TDA 015 900 030	1.5	90°	0.75	3	0.75	45	4	
4TDA 020 600 050	2	60°	0.57	5	1	50	4	
4TDA 020 900 050	2	90°	1	5	1	50	4	
4TDA 025 600 060	2.5	60°	0.75	6	1.2	50	4	
4TDA 025 900 060	2.5	90°	1.3	6	1.2	50	4	
4TDA 030 600 075	3	60°	0.86	7.5	1.5	50	4	
4TDA 030 600 120	3	60°	0.86	12	1.5	50	4	
4TDA 030 900 075	3	90°	1.5	7.5	1.5	50	4	
4TDA 030 900 120	3	90°	1.5	12	1.5	50	4	
4TDA 040 600 100	4	60°	1.15	10	2	50	4	
4TDA 040 600 160	4	60°	1.15	16	2	50	4	
4TDA 040 900 100	4	90°	2	10	2	50	4	
4TDA 040 900 160	4	90°	2	16	2	50	4	
4TDA 050 600 125	5	60°	1.44	12.5	2.5	60	6	
4TDA 050 600 200	5	60°	1.44	20	2.5	60	6	
4TDA 050 900 125	5	90°	2.4	12.5	2.5	60	6	
4TDA 050 900 200	5	90°	2.4	20	2.5	60	6	
4TDA 060 600 150	6	60°	1.73	15	3	60	6	
4TDA 060 600 250	6	60°	1.73	25	3	60	6	
4TDA 060 900 150	6	90°	2.8	15	3	60	6	
4TDA 060 900 250	6	90°	2.8	25	3	60	6	
6TDA 080 600 200	8	60°	2.3	20	4	70	8	
6TDA 080 600 280	8	60°	2.3	28	4	70	8	
6TDA 080 900 200	8	90°	3.8	20	4	70	8	
6TDA 080 900 280	8	90°	3.8	28	4	70	8	
6TDA 100 600 250	10	60°	2.8	25	5	75	10	
6TDA 100 600 350	10	60°	2.8	35	5	75	10	
6TDA 100 900 250	10	90°	4.8	25	5	80	10	
6TDA 100 900 350	10	90°	4.8	35	5	80	10	
6TDA 120 600 300	12	60°	3.4	30	6	80	12	
6TDA 120 600 420	12	60°	3.4	42	6	80	12	
6TDA 120 900 300	12	90°	5.8	30	6	80	12	
6TDA 120 900 420	12	90°	5.8	42	6	80	12	

단위 : mm

GENERAL PURPOSE

### 가공형상에따른절삭가능여부 Available Cutting Shape

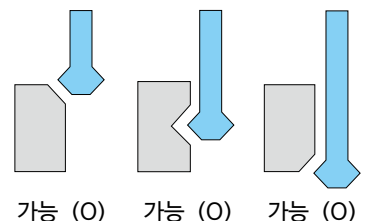

### 3&4날 홈 가공용 커터

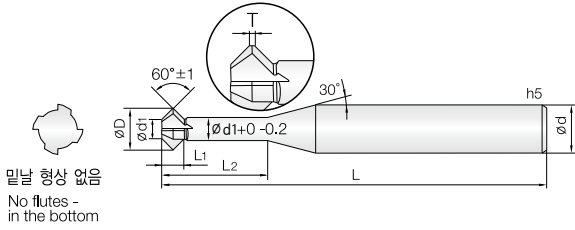

- HRC50이하의 고경도강, 프리하든강, 공구강, 주철 등 피삭재 가공
- JCRO 코팅 처리하여 다양한 피삭재 가공시 인선부에 스트레스가 적으며, 내마모성 또한 향상됩니다.
- 나사홈 가공에 적합한 직선날 형상을 설계하여, 나사홈 가공시의 인선부 치핑을 최소화 하였습니다.
- 다양한 형상과 유효장으로 공작물 간섭을 최소화하여 작업효율이 향상됩니다.
- Endmills for various work materials, hardened steels(HRc~50), pre-hardened steels, tool steels and cast irons**
- JCRO coating provides wear resistance improvement as well as avoid edge stress in various applications.
- Minimize edge chipping and fracturing by applying straight flutes design which is appropriate to screw groove cutting.
- Various shapes and length provides optimum efficiency.

<b>3</b>	<b>4</b>	<b>WC</b> 미립자	<b>JCRO</b> Coating	<b>IT</b> ± 0.01	<b>0°</b> Helix Angle	<b>CUTTING DATA</b>
				Ø0.01 ~ 0.09	496P	

D Size	D Tolerance	d1 Size	d1 Tolerance
Ø 0.57 ~ 4.8	+0 ~ -0.02mm	Ø 0.3 ~ 6.1	+0 ~ -0.02mm
Ø 6.8 ~ 7.9	-0.01 ~ -0.03mm		

단위 : mm

Order Number	날경 Diameter D	두께 Thickness T	날장 Length of cut L1	유효장 Effective Length L2	선단경 Neck Diameter Ød1	전장 Overall Length L	샙크 Shank Dia d	비고
3THC 0057 025 M008	0.57	0.01	0.16	2.5	0.3	40	4	
3THC 0065 028 M009	0.65	0.01	0.18	2.8	0.35	40	4	
3THC 007 030 M01	0.7	0.015	0.19	3	0.4	40	4	
3THC 009 036 M012	0.9	0.015	0.2	3.6	0.57	40	4	
3THC 0105 045 M014	1.05	0.02	0.24	4.5	0.66	40	4	
3THC 012 050 M016	1.2	0.02	0.28	5	0.75	40	4	
4THC 015 060 M02	1.5	0.025	0.31	6	1	45	4	
4THC 019 070 M025	1.9	0.025	0.34	7	1.35	45	4	
4THC 023 090 M03	2.3	0.03	0.43	9	1.6	65	6	
4THC 031 120 M04	3.1	0.04	0.56	12	2.2	65	6	
4THC 040 150 M05	4	0.05	0.62	15	3	65	6	
4THC 048 180 M06	4.8	0.07	0.79	18	3.55	75	6	
4THC 065 230 M08	6.5	0.08	0.94	23	5	80	8	
4THC 079 260 M10	7.9	0.09	1.13	26	6.1	80	8	

가공형상에따른절삭가능여부  
Available Cutting Shape

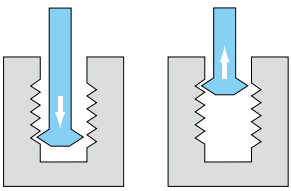

가능 (O)      가능 (O)

GENERAL PURPOSE

# 4&6TAC 4&6 Flutes T-Angular Cutters

## 4&6날 T-앵글 커터

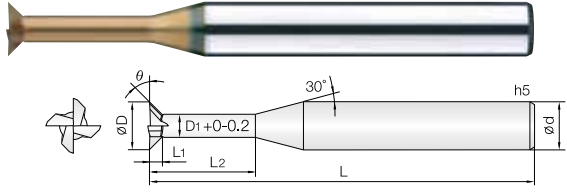

- HRC50이하의 고경도강, 프리하든강, 공구강, 주철 등 피삭재 가공
- JCRO코팅 처리하여 다양한 피삭재 가공시 인선부에 스트레스가 적으며, 내마모성 또한 향상됩니다.
- 직선날 타입 4날을 적용하여 인선부 칩핑을 최소화 하였습니다.
- 다양한 형상과 유효장으로 공작물 간섭을 최소화하여 작업효율이 향상됩니다.

- Endmills for various work materials, hardened steels(HRc~50), pre-hardened steels, tool steels and cast irons
- JCRO coating provides wear resistance improvement as well as avoid edge stress in various applications.
- Minimize edge chipping by applying straight 4flutes design.
- Various shapes and length provides optimum efficiency.



D Size	D Tolerance
Ø 1.5 ~ 5	+0 ~ -0.02mm
Ø 6 ~ 12	-0.01 ~ -0.03mm

Order Number	날경 Diameter D	각도 Angle θ	날장 Length of cut L1	유효장 Effective Length L2	목부경 Neck Diameter D1	전장 Overall Length L	샤프크 Shank Dia d	비고
4TAC 015 300 030	1.5	30°	0.21	3	0.75	45	4	
4TAC 015 450 030	1.5	45°	0.37	3	0.75	45	4	
4TAC 020 300 050	2	30°	0.28	5	1	50	4	
4TAC 020 450 050	2	45°	0.5	5	1	50	4	
4TAC 025 300 060	2.5	30°	0.37	6	1.2	50	4	
4TAC 025 450 060	2.5	45°	0.65	6	1.2	50	4	
4TAC 030 300 075	3	30°	0.43	7.5	1.5	50	4	
4TAC 030 300 120	3	30°	0.43	12	1.5	50	4	
4TAC 030 450 075	3	45°	0.75	7.5	1.5	50	4	
4TAC 030 450 120	3	45°	0.75	12	1.5	50	4	
4TAC 040 300 100	4	30°	0.57	10	2	50	4	
4TAC 040 300 160	4	30°	0.57	16	2	50	4	
4TAC 040 450 100	4	45°	1	10	2	50	4	
4TAC 040 450 160	4	45°	1	16	2	50	4	
4TAC 050 300 125	5	30°	0.72	12.5	2.5	60	6	
4TAC 050 450 125	5	45°	1.25	12.5	2.5	60	6	
4TAC 060 300 150	6	30°	0.86	15	3	60	6	
4TAC 060 300 240	6	30°	0.86	24	3	60	6	
4TAC 060 450 150	6	45°	1.5	15	3	60	6	
4TAC 060 450 240	6	45°	1.5	24	3	60	6	
6TAC 080 300 200	8	30°	1.15	20	4	70	8	
6TAC 080 300 280	8	30°	1.15	28	4	70	8	
6TAC 080 450 200	8	45°	2	20	4	70	8	
6TAC 080 450 280	8	45°	2	28	4	70	8	
6TAC 100 300 250	10	30°	1.44	25	5	75	10	
6TAC 100 300 350	10	30°	1.44	35	5	75	10	
6TAC 100 450 250	10	45°	2.5	25	5	75	10	
6TAC 100 450 350	10	45°	2.5	35	5	75	10	
6TAC 120 300 300	12	30°	1.73	30	6	80	12	
6TAC 120 300 420	12	30°	1.73	42	6	80	12	
6TAC 120 450 300	12	45°	3	30	6	80	12	
6TAC 120 450 420	12	45°	3	42	6	80	12	

단위 : mm

GENERAL PURPOSE

### 가공형상에따른절삭가능여부 Available Cutting Shape

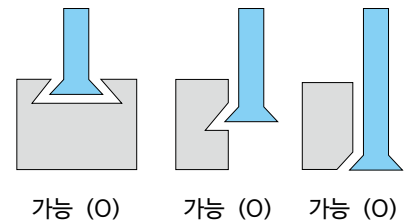

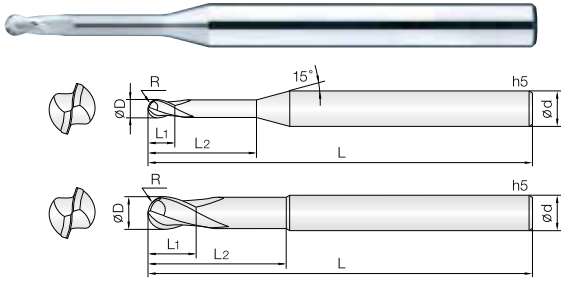

- 아크릴, ABS, 목업, 알루미늄 등 비철, 비금속 피삭재 가공
- 짧은 날장 채택으로 떨림을 최소화 하였습니다.
- 고속, 고이송 작업시 짧은 날장을 채택하여 공구의 강성이 우수합니다.
- 인선부 강성을 보강하여 날부치핑을 최소화 하였습니다.
- 미립자 초경합금을 채택하여 내마모성이 좋습니다.

#### Endmills for Acryl, A.B.S, Aluminum, non-ferrous and non-metallic materials

- Minimize chattering by short flute design.
- Excellent tool rigidity by short flute design at high speed, feed machining.
- Reinforced edge design for preventing edge chipping.
- Excellent wear resistance by applying fine WC grade.

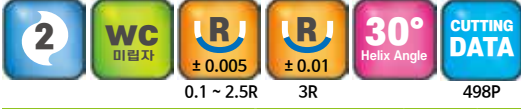

Condition	D Size	D Tolerance	Condition	D Size	D Tolerance
ØD ≠ Ød	Ø0.2 ~ 6	+0 ~ -0.01mm	ØD = Ød	Ø6	-0.005 ~ -0.015mm

단위 : mm

Order Number	날경 Diameter R × D	날장 Length of cut L1	유효장 Effective Length L2	전장 Overall Length L	샙크 Shank Dia d	비고
2MRB 002 005 S04	0.1R X 0.2	0.3	0.5	40	4	
2MRB 002 010 S04	0.1R X 0.2	0.3	1	40	4	
2MRB 002 015 S04	0.1R X 0.2	0.3	1.5	40	4	
2MRB 002 020 S04	0.1R X 0.2	0.3	2	40	4	
2MRB 003 010 S04	0.15R X 0.3	0.45	1	40	4	
2MRB 003 020 S04	0.15R X 0.3	0.45	2	40	4	
2MRB 003 030 S04	0.15R X 0.3	0.45	3	40	4	
2MRB 003 050 S04	0.15R X 0.3	0.45	5	40	4	
2MRB 004 020 S04	0.2R X 0.4	0.6	2	40	4	
2MRB 004 030 S04	0.2R X 0.4	0.6	3	40	4	
2MRB 004 040 S04	0.2R X 0.4	0.6	4	40	4	
2MRB 004 050 S04	0.2R X 0.4	0.6	5	40	4	
2MRB 004 060 S04	0.2R X 0.4	0.6	6	40	4	
2MRB 005 020 S04	0.25R X 0.5	1	2	45	4	
2MRB 005 040 S04	0.25R X 0.5	1	4	45	4	
2MRB 005 060 S04	0.25R X 0.5	1	6	45	4	
2MRB 005 080 S04	0.25R X 0.5	1	8	45	4	
2MRB 005 100 S04	0.25R X 0.5	1	10	45	4	
2MRB 006 020 S04	0.3R X 0.6	1.2	2	45	4	
2MRB 006 040 S04	0.3R X 0.6	1.2	4	45	4	
2MRB 006 060 S04	0.3R X 0.6	1.2	6	45	4	
2MRB 006 080 S04	0.3R X 0.6	1.2	8	45	4	
2MRB 006 100 S04	0.3R X 0.6	1.2	10	45	4	
2MRB 007 040 S04	0.35R X 0.7	1.4	4	45	4	
2MRB 007 060 S04	0.35R X 0.7	1.4	6	45	4	
2MRB 007 080 S04	0.35R X 0.7	1.4	8	45	4	
2MRB 007 100 S04	0.35R X 0.7	1.4	10	45	4	
2MRB 008 040 S04	0.4R X 0.8	1.6	4	45	4	
2MRB 008 060 S04	0.4R X 0.8	1.6	6	45	4	
2MRB 008 080 S04	0.4R X 0.8	1.6	8	45	4	
2MRB 008 100 S04	0.4R X 0.8	1.6	10	45	4	
2MRB 008 120 S04	0.4R X 0.8	1.6	12	45	4	
2MRB 009 060 S04	0.45R X 0.9	1.8	6	45	4	
2MRB 009 100 S04	0.45R X 0.9	1.8	10	45	4	
2MRB 009 120 S04	0.45R X 0.9	1.8	12	45	4	
2MRB 010 060 S04	0.5R X 1	2	6	50	4	
2MRB 010 080 S04	0.5R X 1	2	8	50	4	
2MRB 010 100 S04	0.5R X 1	2	10	50	4	
2MRB 010 120 S04	0.5R X 1	2	12	50	4	
2MRB 010 160 S04	0.5R X 1	2	16	50	4	
2MRB 010 200 S04	0.5R X 1	2	20	60	4	
2MRB 010 250 S04	0.5R X 1	2	25	60	4	
2MRB 012 060 S04	0.6R X 1.2	2.4	6	50	4	
2MRB 012 080 S04	0.6R X 1.2	2.4	8	50	4	
2MRB 012 100 S04	0.6R X 1.2	2.4	10	50	4	
2MRB 012 120 S04	0.6R X 1.2	2.4	12	50	4	
2MRB 012 160 S04	0.6R X 1.2	2.4	16	50	4	
2MRB 014 060 S04	0.7R X 1.4	2.8	6	50	4	
2MRB 014 100 S04	0.7R X 1.4	2.8	10	50	4	
2MRB 014 160 S04	0.7R X 1.4	2.8	16	50	4	

Order Number	날경 Diameter R × D	날장 Length of cut L1	유효장 Effective Length L2	전장 Overall Length L	샙크 Shank Dia d	비고
2MRB 015 060 S04	0.75R X 1.5	3	6	50	4	
2MRB 015 100 S04	0.75R X 1.5	3	10	50	4	
2MRB 015 140 S04	0.75R X 1.5	3	14	50	4	
2MRB 015 160 S04	0.75R X 1.5	3	16	50	4	
2MRB 015 200 S04	0.75R X 1.5	3	20	60	4	
2MRB 015 250 S04	0.75R X 1.5	3	25	60	4	
2MRB 015 300 S04	0.75R X 1.5	3	30	70	4	
2MRB 016 060 S04	0.8R X 1.6	3.2	6	50	4	
2MRB 020 080 S04	1R X 2	4	8	50	4	
2MRB 020 100 S04	1R X 2	4	10	50	4	
2MRB 020 120 S04	1R X 2	4	12	50	4	
2MRB 020 140 S04	1R X 2	4	14	50	4	
2MRB 020 160 S04	1R X 2	4	16	50	4	
2MRB 020 180 S04	1R X 2	4	18	50	4	
2MRB 020 200 S04	1R X 2	4	20	60	4	
2MRB 020 250 S04	1R X 2	4	25	60	4	
2MRB 020 300 S04	1R X 2	4	30	70	4	
2MRB 020 350 S04	1R X 2	4	35	80	4	
2MRB 020 400 S04	1R X 2	4	40	80	4	
2MRB 025 120 S04	1.25R X 2.5	5	12	60	4	
2MRB 025 200 S04	1.25R X 2.5	5	20	60	4	
2MRB 030 080 S06	1.5R X 3	6	8	70	6	
2MRB 030 120 S06	1.5R X 3	6	12	70	6	
2MRB 030 160 S06	1.5R X 3	6	16	70	6	
2MRB 030 200 S06	1.5R X 3	6	20	70	6	
2MRB 030 250 S06	1.5R X 3	6	25	70	6	
2MRB 030 300 S06	1.5R X 3	6	30	80	6	
2MRB 030 400 S06	1.5R X 3	6	40	90	6	
2MRB 030 450 S06	1.5R X 3	6	45	90	6	
2MRB 040 120 S06	2R X 4	8	12	70	6	
2MRB 040 160 S06	2R X 4	8	16	70	6	
2MRB 040 200 S06	2R X 4	8	20	70	6	
2MRB 040 250 S06	2R X 4	8	25	70	6	
2MRB 040 300 S06	2R X 4	8	30	70	6	
2MRB 040 350 S06	2R X 4	8	35	80	6	
2MRB 040 400 S06	2R X 4	8	40	80	6	
2MRB 040 500 S06	2R X 4	8	50	100	6	
2MRB 050 160 S06	2.5R X 5	10	16	80	6	
2MRB 050 250 S06	2.5R X 5	10	25	80	6	
2MRB 050 350 S06	2.5R X 5	10	35	80	6	
2MRB 060 250 S06	3R X 6	12	25	80	6	
2MRB 060 350 S06	3R X 6	12	35	80	6	
2MRB 060 500 S06	3R X 6	12	50	120	6	
2MRB 060 600 S06	3R X 6	12	60	120	6	

### 3날 범용 마이크로 리브 볼 엔드밀

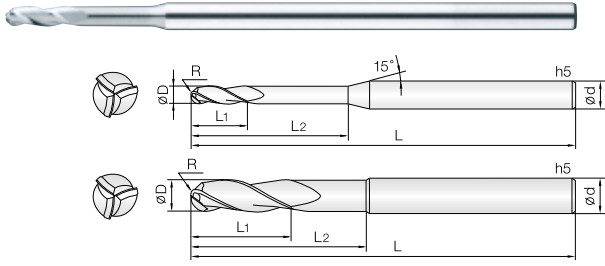

3 미립자
WC ±0.005
0.5 ~ 2R
R ±0.01
3 ~ 6R
R ±0.015
8R
30° Helix Angle
498P
CUTTING DATA

- 아크릴, ABS, 목업, 알루미늄 등 비철, 비금속 피삭재 가공
- 짧은 날장 채택으로 떨림을 최소화 하였습니다.
- 고속, 고이송 작업시 짧은 날장을 채택하여 공구의 강성이 우수합니다.
- 인선부 강성을 보강하여 날부치핑을 최소화 하였습니다.
- 미립자 조경합금을 채택하여 내마모성이 좋습니다.

#### Endmills for Acryl, A.B.S, Aluminum, non-ferrous and non-metallic materials

- Minimize chattering by short flute design.
- Excellent tool rigidity by short flute design at high speed, feed machining.
- Reinforced edge design for preventing edge chipping.
- Excellent wear resistance by applying fine WC grade.

Condition	D Size	D Tolerance	Condition	D Size	D Tolerance
ØD ≠ ød	Ø0.1 ~ 0.19	+0 ~ -0.005mm	ØD = ød	Ø3 ~ 12	-0.005 ~ -0.015mm
	Ø0.2 ~ 25	+0 ~ -0.01mm		Ø12.1 ~ 25	-0.01 ~ -0.02mm

단위 : mm

Order Number	날경 Diameter R × D	날장 Length of cut L1	유효장 Effective Length L2	전장 Overall Length L	생크 Shank Dia d	비고	Order Number	날경 Diameter R × D	날장 Length of cut L1	유효장 Effective Length L2	전장 Overall Length L	생크 Shank Dia d	비고
3MRB 010 050 S04	0.5R X 1	3	5	70	4								
3MRB 010 100 S04	0.5R X 1	3	10	70	4								
3MRB 010 150 S04	0.5R X 1	3	15	70	4								
3MRB 010 200 S04	0.5R X 1	3	20	70	4								
3MRB 010 250 S04	0.5R X 1	3	25	70	4								
3MRB 015 100 S04	0.75R X 1.5	4.5	10	70	4								
3MRB 015 150 S04	0.75R X 1.5	4.5	15	70	4								
3MRB 015 200 S04	0.75R X 1.5	4.5	20	70	4								
3MRB 015 250 S04	0.75R X 1.5	4.5	25	70	4								
3MRB 015 300 S04	0.75R X 1.5	4.5	30	70	4								
3MRB 020 100 S04	1R X 2	6	10	70	4								
3MRB 020 150 S04	1R X 2	6	15	70	4								
3MRB 020 200 S04	1R X 2	6	20	70	4								
3MRB 020 250 S04	1R X 2	6	25	70	4								
3MRB 020 300 S04	1R X 2	6	30	70	4								
3MRB 030 200 080	1.5R X 3	15	20	80	3								
3MRB 030 200 S04	1.5R X 3	9	20	80	4								
3MRB 030 300 100	1.5R X 3	15	30	100	3								
3MRB 030 300 S04	1.5R X 3	9	30	80	4								
3MRB 040 200 080	2R X 4	12	20	80	4								
3MRB 040 300 100	2R X 4	12	30	100	4								
3MRB 060 300 100	3R X 6	18	30	100	6								
3MRB 060 400 150	3R X 6	18	40	150	6								
3MRB 080 400 120	4R X 8	24	40	120	8								
3MRB 080 500 150	4R X 8	24	50	150	8								
3MRB 100 500 120	5R X 10	30	50	120	10								
3MRB 100 600 150	5R X 10	30	60	150	10								
3MRB 120 600 150	6R X 12	36	60	150	12								
3MRB 160 700 160	8R X 16	54	70	160	16								

FOR A.B.S



2날 ABS수지 가공용 마이크로 롱 볼 엔드밀

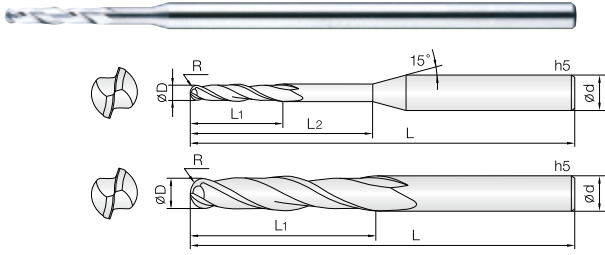

- 아크릴, ABS, 목업, 알루미늄 등 비철, 비금속 피삭재 전용 엔드밀
- 균일한 런아웃 공차관리로 떨림을 최소화 하였습니다.
- 깊은 피삭재 가공시 긴 날장을 채택하여 가공이 용이하며, 칩배출이 좋습니다.
- 미립자 초경합금을 채택하여 내마모성이 좋습니다.

Endmills for Acryl, A.B.S, Aluminum, non-ferrous and non-metallic materials

- Minimize chattering by even run-out and tolerance control.
- Long flute helps chip control in deep groove machining.
- Excellent wear resistance by applying fine WC grade.



Condition	D Size	D Tolerance	Condition	D Size	D Tolerance
ØD ≠ Ød	Ø0.2 ~ 6	+0 ~ -0.01mm	ØD = Ød	Ø3 ~ 6	-0.005 ~ -0.015mm
	Ø8 ~ 16	+0 ~ -0.015mm		Ø8 ~ 12	-0.01 ~ -0.025mm
				Ø16	-0.015 ~ -0.03mm

단위 : mm

Order Number	날경 Diameter R × D	날장 Length of cut L1	유효장 Effective Length L2	전장 Overall Length L	샤프트 직경 Shank Dia d	비고
2MLB 002 010 S03	0.1R X 0.2	0.4	1	40	3	
2MLB 002 015 S03	0.1R X 0.2	0.4	1.5	40	3	
2MLB 002 020 S03	0.1R X 0.2	0.4	2	40	3	
2MLB 003 010 S03	0.15R X 0.3	1	-	45	3	
2MLB 003 015 S03	0.15R X 0.3	1	1.5	45	3	
2MLB 003 018 S03	0.15R X 0.3	1.8	-	45	3	
2MLB 003 020 S03	0.15R X 0.3	1	2	45	3	
2MLB 003 025 S03	0.15R X 0.3	1	2.5	45	3	
2MLB 003 030 S03	0.15R X 0.3	1	3	45	3	
2MLB 003 040 S03	0.15R X 0.3	1	4	45	3	
2MLB 004 012 S03	0.2R X 0.4	1.2	-	45	3	
2MLB 004 020 S03	0.2R X 0.4	2	-	45	3	
2MLB 004 030 S03	0.2R X 0.4	1.2	3	45	3	
2MLB 004 040 S03	0.2R X 0.4	1.2	4	45	3	
2MLB 004 050 S03	0.2R X 0.4	1.2	5	45	3	
2MLB 005 015 S03	0.25R X 0.5	1.5	-	50	3	
2MLB 005 020 S03	0.25R X 0.5	2	-	50	3	
2MLB 005 030 S03	0.25R X 0.5	1.5	3	50	3	
2MLB 005 040 S03	0.25R X 0.5	1.5	4	50	3	
2MLB 005 050 S03	0.25R X 0.5	1.5	5	50	3	
2MLB 005 060 S03	0.25R X 0.5	1.5	6	50	3	
2MLB 005 080 S03	0.25R X 0.5	1.5	8	50	3	
2MLB 005 100 S03	0.25R X 0.5	1.5	10	50	3	
2MLB 006 030 S03	0.3R X 0.6	3	-	50	3	
2MLB 006 060 S03	0.3R X 0.6	3	6	50	3	
2MLB 006 080 S03	0.3R X 0.6	3	8	50	3	
2MLB 006 100 S03	0.3R X 0.6	3	10	50	3	
2MLB 007 030 S03	0.35R X 0.7	3	-	50	3	
2MLB 007 070 S03	0.35R X 0.7	3	7	50	3	
2MLB 007 100 S03	0.35R X 0.7	3	10	50	3	
2MLB 007 120 S03	0.35R X 0.7	3	12	50	3	
2MLB 008 040 S03	0.4R X 0.8	4	-	50	3	
2MLB 008 080 S03	0.4R X 0.8	4	8	50	3	
2MLB 008 100 S03	0.4R X 0.8	4	10	50	3	
2MLB 008 120 S03	0.4R X 0.8	4	12	50	3	
2MLB 009 040 S03	0.45R X 0.9	4	-	50	3	
2MLB 009 060 S03	0.45R X 0.9	4	6	50	3	
2MLB 009 080 S03	0.45R X 0.9	4	8	50	3	
2MLB 009 100 S03	0.45R X 0.9	4	10	50	3	
2MLB 010 050 S03	0.5R X 1	5	-	80	3	
2MLB 010 050 S04	0.5R X 1	5	-	80	4	
2MLB 010 100 S03	0.5R X 1	5	10	80	3	
2MLB 010 100 S04	0.5R X 1	5	10	80	4	
2MLB 010 150 S03	0.5R X 1	5	15	80	3	
2MLB 010 150 S04	0.5R X 1	5	15	80	4	
2MLB 010 200 S03	0.5R X 1	5	20	80	3	
2MLB 010 200 S04	0.5R X 1	5	20	80	4	
2MLB 010 250 S03	0.5R X 1	5	25	80	3	
2MLB 010 250 S04	0.5R X 1	5	25	80	4	
2MLB 010 300 S03	0.5R X 1	5	30	80	3	

Order Number	날경 Diameter R × D	날장 Length of cut L1	유효장 Effective Length L2	전장 Overall Length L	샤프트 직경 Shank Dia d	비고
2MLB 010 300 S04	0.5R X 1	5	30	80	4	
2MLB 010 350 S04	0.5R X 1	5	35	100	4	
2MLB 010 400 S04	0.5R X 1	5	40	100	4	
2MLB 015 100 S03	0.75R X 1.5	10	-	80	3	
2MLB 015 100 S04	0.75R X 1.5	10	-	80	4	
2MLB 015 150 S03	0.75R X 1.5	10	15	80	3	
2MLB 015 150 S04	0.75R X 1.5	10	15	80	4	
2MLB 015 200 S03	0.75R X 1.5	10	20	80	3	
2MLB 015 200 S04	0.75R X 1.5	10	20	80	4	
2MLB 015 250 S03	0.75R X 1.5	10	25	80	3	
2MLB 015 250 S04	0.75R X 1.5	10	25	80	4	
2MLB 015 300 S03	0.75R X 1.5	10	30	80	3	
2MLB 015 300 S04	0.75R X 1.5	10	30	80	4	
2MLB 015 350 S04	0.75R X 1.5	10	35	100	4	
2MLB 015 400 S04	0.75R X 1.5	10	40	100	4	
2MLB 020 100 S03	1R X 2	10	-	80	3	
2MLB 020 100 S04	1R X 2	10	-	80	4	
2MLB 020 150 S03	1R X 2	10	15	80	3	
2MLB 020 150 S04	1R X 2	10	15	80	4	
2MLB 020 200 S03	1R X 2	10	20	80	3	
2MLB 020 200 S04	1R X 2	10	20	80	4	
2MLB 020 250 S03	1R X 2	10	25	80	3	
2MLB 020 250 S04	1R X 2	10	25	80	4	
2MLB 020 300 S03	1R X 2	10	30	80	3	
2MLB 020 300 S04	1R X 2	10	30	80	4	
2MLB 020 350 S03	1R X 2	10	35	80	3	
2MLB 020 350 S04	1R X 2	10	35	100	4	
2MLB 020 400 S03	1R X 2	10	40	80	3	
2MLB 020 400 S04	1R X 2	10	40	100	4	
2MLB 025 100 S03	1.25R X 2.5	10	-	80	3	
2MLB 025 150 S03	1.25R X 2.5	15	-	80	3	
2MLB 025 200 S03	1.25R X 2.5	15	20	80	3	
2MLB 030 100 O60	1.5R X 3	10	-	60	3	
2MLB 030 200 O80	1.5R X 3	20	-	80	3	
2MLB 030 200 100	1.5R X 3	20	-	100	3	
2MLB 030 200 120	1.5R X 3	20	-	120	3	
2MLB 030 150 S06	1.5R X 3	15	-	100	6	
2MLB 030 200 S06	1.5R X 3	15	20	100	6	
2MLB 030 250 S06	1.5R X 3	15	25	100	6	
2MLB 030 300 S06	1.5R X 3	15	30	100	6	
2MLB 030 400 S06	1.5R X 3	15	40	100	6	
2MLB 040 200 O80	2R X 4	20	-	80	4	
2MLB 040 200 100	2R X 4	20	-	100	4	
2MLB 040 200 130	2R X 4	20	-	130	4	
2MLB 040 200 S06	2R X 4	20	-	100	6	
2MLB 040 250 S06	2R X 4	20	25	100	6	
2MLB 040 300 S06	2R X 4	20	30	100	6	
2MLB 040 400 S06	2R X 4	20	40	120	6	
2MLB 040 500 S06	2R X 4	20	50	120	6	
2MLB 050 300 100	2.5R X 5	30	-	100	5	





단위 : mm

Order Number	날경 Diameter R x D	날장 Length of cut L1	유효장 Effective Length L2	전장 Overall Length L	생크 Shank Dia d	비고	Order Number	날경 Diameter R x D	날장 Length of cut L1	유효장 Effective Length L2	전장 Overall Length L	생크 Shank Dia d	비고
2MLB 050 300 120	2.5R X 5	30	-	120	5								
2MLB 060 300 080	3R X 6	30	-	80	6								
2MLB 060 400 100	3R X 6	40	-	100	6								
2MLB 060 400 120	3R X 6	40	-	120	6								
2MLB 060 400 150	3R X 6	40	-	150	6								
2MLB 080 450 120	4R X 8	45	-	120	8								
2MLB 080 450 150	4R X 8	45	-	150	8								
2MLB 100 500 120	5R X 10	50	-	120	10								
2MLB 100 500 150	5R X 10	50	-	150	10								
2MLB 120 550 130	6R X 12	55	-	130	12								
2MLB 120 550 150	6R X 12	55	-	150	12								
2MLB 160 700 160	8R X 16	70	-	160	16								

FOR A.B.S

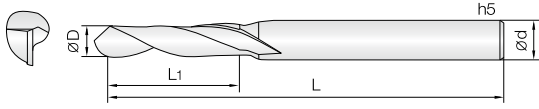

- 아크릴, ABS, 목업, 알루미늄 등 비철, 비금속 피삭재 가공
- 헬릭스 1날 타입으로 칩 배출이 우수하여 비철, 비금속 피삭재의 절단 작업 및 측벽 작업에 적합합니다.
- 미립자 초경합금을 채택하여 내마모성이 좋습니다.

- **Endmills for Acryl, A.B.S, Aluminum, non-ferrous and non-metallic materials.**
- Excellent chip removing by a helix 1 flute design. Optimum for cut-off and wall machining.
- Excellent wear resistance by applying fine WC grade.

1

WC

R

R

R

30°

CUTTING DATA

0.5 ~ 2.5R    3 ~ 6R    8R    499P

Condition	D Size	D Tolerance	Condition	D Size	D Tolerance
$\varnothing D \neq \varnothing d$	$\varnothing 2 \sim 16$	+0 ~ -0.01mm	$\varnothing D = \varnothing d$	$\varnothing 3 \sim 12$	-0.005 ~ -0.015mm
				$\varnothing 16$	-0.01 ~ -0.02mm

단위 : mm

Order Number	날경 Diameter D	날장 Length of cut L1	전장 Overall Length L	생크 Shank Dia d	비고
1MBE 010 040 S03	0.5R X 1	4	40	3	
1MBE 015 060 S03	0.75R X 1.5	6	40	3	
1MBE 020 060 S03	1R X 2	6	40	3	
1MBE 020 100 S06	1R X 2	10	60	6	
1MBE 020 120 S06	1R X 2	12	60	6	
1MBE 030 120 040	1.5R X 3	12	40	3	
1MBE 030 120 S06	1.5R X 3	12	60	6	
1MBE 030 150 S06	1.5R X 3	15	60	6	
1MBE 040 150 S60	2R X 4	15	60	6	
1MBE 040 150 080	2R X 4	15	80	6	
1MBE 050 160 S06	2.5R X 5	16	60	6	
1MBE 060 200 060	3R X 6	20	60	6	
1MBE 060 250 080	3R X 6	25	80	6	
1MBE 060 300 100	3R X 6	30	100	6	
1MBE 080 300 080	4R X 8	30	80	8	
1MBE 080 350 120	4R X 8	35	120	8	
1MBE 100 350 100	5R X 10	35	100	10	
1MBE 100 450 120	5R X 10	45	120	10	
1MBE 100 550 150	5R X 10	55	150	10	
1MBE 120 450 110	6R X 12	45	110	12	
1MBE 120 550 130	6R X 12	55	130	12	
1MBE 120 600 150	6R X 12	60	150	12	
1MBE 160 550 160	8R X 16	55	160	16	
1MBE 160 650 200	8R X 16	65	200	16	

FOR A.B.S

# 2MBE 2 Flutes Ball End Mills

## 2날 범용 볼 엔드밀

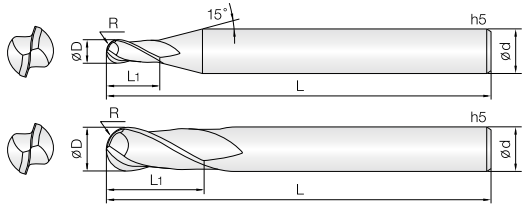

- 일반강, 아크릴, ABS, 목업, 알루미늄 등 비철, 비금속 피삭재 가공
- 균일한 런아웃 공차관리로 떨림을 최소화 하였습니다.
- 날부인선의 조도가 뛰어나 피삭재의 면조도가 우수합니다.
- 미립자 초경합금을 채택하여 내마모성이 좋습니다.

### Endmills for Mild steel, Acryl, A.B.S, Aluminum, non-ferrous and non-metallic materials.

- Minimize chattering by even run-out and tolerance control.
- Very nice work surface finish.
- Excellent wear resistance by applying fine WC grade.



0.05 ~ 2.5R 3 ~ 6R 500P

Condition	D Size	D Tolerance	Condition	D Size	D Tolerance
ØD ≠ Ød	Ø0.1 ~ 0.15	+0 ~ -0.005mm	ØD = Ød	Ø3 ~ 12	-0.005 ~ -0.015mm
	Ø0.2 ~ 12	+0 ~ -0.01mm			

단위 : mm

Order Number	날경 Diameter R × D	날장 Length of cut L1	전장 Overall Length L	샤프트 Dia d	비고	Order Number	날경 Diameter R × D	날장 Length of cut L1	전장 Overall Length L	샤프트 Dia d	비고
2MBE 001 002 S03	0.05R X 0.1	0.2	40	3							
2MBE 0015 003 S03	0.075R X 0.15	0.3	40	3							
2MBE 002 004 S03	0.1R X 0.2	0.4	40	3							
2MBE 003 006 S03	0.15R X 0.3	0.6	40	3							
2MBE 004 008 S03	0.2R X 0.4	0.8	40	3							
2MBE 005 010 S03	0.25R X 0.5	1	40	3							
2MBE 006 012 S03	0.3R X 0.6	1.2	40	3							
2MBE 007 014 S03	0.35R X 0.7	1.4	40	3							
2MBE 008 016 S03	0.4R X 0.8	1.6	40	3							
2MBE 009 018 S03	0.45R X 0.9	1.8	40	3							
2MBE 010 025 S03	0.5R X 1	2.5	50	3							
2MBE 010 025 S06	0.5R X 1	2.5	50	6							
2MBE 010 025 100	0.5R X 1	2.5	100	6							
2MBE 011 025 S03	0.55R X 1.1	2.5	50	3							
2MBE 012 030 S03	0.6R X 1.2	3	50	3							
2MBE 015 040 S03	0.75R X 1.5	4	50	3							
2MBE 015 040 100	0.75R X 1.5	4	100	6							
2MBE 020 050 S03	1R X 2	5	50	3							
2MBE 020 050 S06	1R X 2	5	50	6							
2MBE 020 050 100	1R X 2	5	100	6							
2MBE 025 060 S03	1.25R X 2.5	6	50	3							
2MBE 025 060 100	1.25R X 2.5	6	100	6							
2MBE 030 080 S03	1.5R X 3	8	60	3							
2MBE 030 080 S06	1.5R X 3	8	60	6							
2MBE 030 080 100	1.5R X 3	8	100	6							
2MBE 035 080 S06	1.75R X 3.5	8	65	6							
2MBE 040 080 S06	2R X 4	8	70	6							
2MBE 040 080 120	2R X 4	8	120	6							
2MBE 050 120 S06	2.5R X 5	12	75	6							
2MBE 060 120 080	3R X 6	12	80	6							
2MBE 060 120 100	3RX 6	12	100	6							
2MBE 080 140 090	4R X 8	14	90	8							
2MBE 080 140 110	4RX 8	14	110	8							
2MBE 100 180 100	5R X 10	18	100	10							
2MBE 100 180 120	5RX 10	18	120	10							
2MBE 120 220 110	6R X 12	22	110	12							
2MBE 120 220 130	6RX 12	22	130	12							

FOR A.B.S



# 1MEM 1 Flute End Mills

## 1날 엔드밀

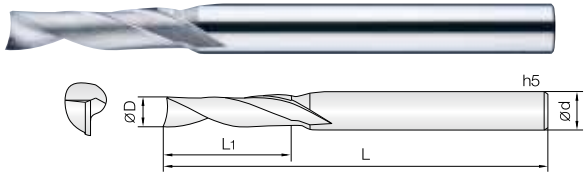

- 아크릴, ABS, 목업, 알루미늄 등 비철, 비금속 피삭재 전용 엔드밀
- 헬릭스 1날 타입으로 칩 배출이 우수하여 비철, 비금속 피삭재의 절단 작업 및 측벽 작업에 적합합니다.
- 미립자 초경합금을 채택하여 내마모성이 좋습니다.

### • Endmills for Acryl, A.B.S, Aluminum, non-ferrous and non-metallic materials

- Excellent chip removing by a helix 1 flute design.
- Optimum for cut-off and wall machining.
- Excellent wear resistance by applying fine WC grade.

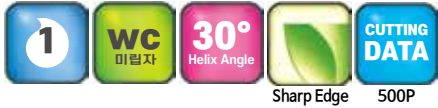

Condition	D Size	D Tolerance	Condition	D Size	D Tolerance
øD ≠ ød	ø0.2 ~ 6	+0 ~ -0.01mm	øD = ød	ø6	-0.005 ~ -0.015mm
	ø8 ~ 12	+0 ~ -0.015mm		ø8 ~ 12	-0.01 ~ -0.025mm

단위 : mm

Order Number	날경 Diameter D	날장 Length of cut L1	전장 Overall Length L	샙크 Dia d	비고	Order Number	날경 Diameter D	날장 Length of cut L1	전장 Overall Length L	샙크 Dia d	비고
1MEM 002 004 S04	0.2	0.4	40	4		1MEM 050 130 S06	5	13	60	6	
1MEM 002 005 S04	0.2	0.5	40	4		1MEM 050 200 S06	5	20	60	6	
1MEM 003 006 S04	0.3	0.6	40	4		1MEM 050 250 S06	5	25	60	6	
1MEM 003 009 S04	0.3	0.9	40	4		1MEM 050 300 S06	5	30	75	6	
1MEM 004 008 S04	0.4	0.8	40	4		1MEM 060 150 S06	6	15	60	6	
1MEM 004 012 S04	0.4	1.2	40	4		1MEM 060 200 S06	6	20	60	6	
1MEM 005 010 S04	0.5	1	40	4		1MEM 060 250 S06	6	25	60	6	
1MEM 005 015 S04	0.5	1.5	40	4		1MEM 060 300 S06	6	30	70	6	
1MEM 006 012 S04	0.6	1.2	40	4		1MEM 060 410 S06	6	41	90	6	
1MEM 006 018 S04	0.6	1.8	40	4		1MEM 080 190 S08	8	19	70	8	
1MEM 007 014 S04	0.7	1.4	40	4		1MEM 080 250 S08	8	25	75	8	
1MEM 007 021 S04	0.7	2.1	40	4		1MEM 080 300 S08	8	30	80	8	
1MEM 008 016 S04	0.8	1.6	40	4		1MEM 080 410 S08	8	41	90	8	
1MEM 008 024 S04	0.8	2.4	40	4		1MEM 100 220 S10	10	22	75	10	
1MEM 009 018 S04	0.9	1.8	40	4		1MEM 100 300 S10	10	30	80	10	
1MEM 009 027 S04	0.9	2.7	40	4		1MEM 100 410 S10	10	41	100	10	
1MEM 010 025 S06	1	2.5	45	6		1MEM 120 260 S12	12	26	75	12	
1MEM 010 030 S06	1	3	45	6		1MEM 120 350 S12	12	35	90	12	
1MEM 010 035 S06	1	3.5	45	6		1MEM 120 510 S12	12	51	110	12	
1MEM 010 045 S06	1	4.5	45	6							
1MEM 010 060 S06	1	6	50	6							
1MEM 010 070 S06	1	7	50	6							
1MEM 012 030 S06	1.2	3	45	6							
1MEM 012 050 S06	1.2	5	45	6							
1MEM 012 060 S06	1.2	6	50	6							
1MEM 015 040 S06	1.5	4	45	6							
1MEM 015 060 S06	1.5	6	50	6							
1MEM 015 080 S06	1.5	8	50	6							
1MEM 015 100 S06	1.5	10	50	6							
1MEM 015 120 S06	1.5	12	50	6							
1MEM 020 060 S06	2	6	50	6							
1MEM 020 080 S06	2	8	50	6							
1MEM 020 100 S06	2	10	50	6							
1MEM 020 120 S06	2	12	50	6							
1MEM 020 140 S06	2	14	55	6							
1MEM 020 160 S06	2	16	60	6							
1MEM 025 080 S06	2.5	8	50	6							
1MEM 025 100 S06	2.5	10	50	6							
1MEM 025 120 S06	2.5	12	50	6							
1MEM 025 160 S06	2.5	16	60	6							
1MEM 030 080 S06	3	8	50	6							
1MEM 030 120 S06	3	12	50	6							
1MEM 030 150 S06	3	15	50	6							
1MEM 030 200 S06	3	20	60	6							
1MEM 030 250 S06	3	25	70	6							
1MEM 040 100 S06	4	10	50	6							
1MEM 040 150 S06	4	15	50	6							
1MEM 040 200 S06	4	20	60	6							
1MEM 040 250 S06	4	25	70	6							
1MEM 040 300 S06	4	30	75	6							

FOR A.B.S

### 1날 역날 엔드밀

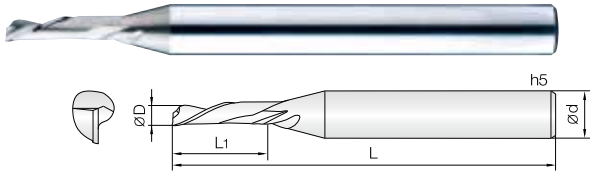

- 아크릴, ABS, 목업, 알루미늄 등 비철, 비금속 피삭재 전용 엔드밀
- 역 헬릭스 타입으로 칩 배출이 아래 방향으로 배출되어, 작업시 피삭재가 떠오르는 현상이 없습니다.
- 피삭재에 상면 버가 발생하지 않습니다.
- 피삭재의 정착이 불안정한 경우 적합합니다.
- 미립자 초경합금을 채택하여 내마모성이 좋습니다.

#### Endmills for Acryl, A.B.S, Aluminum, non-ferrous and non-metallic materials

- Downward chip direction by reverse helix design helps chip control.
- No burr in work materials.
- Optimum for unstable work clamping.
- Excellent wear resistance by applying fine WC grade.



Sharp Edge 500P

Condition	D Size	D Tolerance	Condition	D Size	D Tolerance
ØD ≠ Ød	Ø0.5 ~ 6	+0 ~ -0.01mm	ØD = Ød	Ø6	-0.005 ~ -0.015mm
	Ø8 ~ 12	+0 ~ -0.015mm		Ø8 ~ 12	-0.01 ~ -0.025mm

단위 : mm

Order Number	날경 Diameter D	날장 Length of cut L1	전장 Overall Length L	생크 Shank Dia d	비고	Order Number	날경 Diameter D	날장 Length of cut L1	전장 Overall Length L	생크 Shank Dia d	비고
1REM 005 010 S04	0.5	1	45	4							
1REM 005 015 S04	0.5	1.5	45	4							
1REM 005 020 S04	0.5	2	45	4							
1REM 006 012 S04	0.6	1.2	45	4							
1REM 006 018 S04	0.6	1.8	45	4							
1REM 006 025 S04	0.6	2.5	45	4							
1REM 007 014 S04	0.7	1.4	45	4							
1REM 007 021 S04	0.7	2.1	45	4							
1REM 008 016 S04	0.8	1.6	45	4							
1REM 008 024 S04	0.8	2.4	45	4							
1REM 008 030 S04	0.8	3	45	4							
1REM 009 018 S04	0.9	1.8	45	4							
1REM 010 030 S06	1	3	50	6							
1REM 010 040 S06	1	4	50	6							
1REM 010 050 S06	1	5	50	6							
1REM 010 060 S06	1	6	60	6							
1REM 012 040 S06	1.2	4	50	6							
1REM 012 060 S06	1.2	6	50	6							
1REM 015 040 S06	1.5	4	50	6							
1REM 015 060 S06	1.5	6	50	6							
1REM 015 080 S06	1.5	8	50	6							
1REM 020 060 S06	2	6	60	6							
1REM 020 080 S06	2	8	60	6							
1REM 020 100 S06	2	10	60	6							
1REM 020 120 S06	2	12	60	6							
1REM 025 060 S06	2.5	6	60	6							
1REM 025 080 S06	2.5	8	60	6							
1REM 025 100 S06	2.5	10	60	6							
1REM 030 080 S06	3	8	60	6							
1REM 030 120 S06	3	12	65	6							
1REM 030 160 S06	3	16	70	6							
1REM 040 120 S06	4	12	65	6							
1REM 040 160 S06	4	16	70	6							
1REM 040 200 S06	4	20	70	6							
1REM 050 150 S06	5	15	70	6							
1REM 050 220 S06	5	22	75	6							
1REM 060 270 S06	6	27	75	6							
1REM 080 260 S08	8	26	80	8							
1REM 080 320 S08	8	32	90	8							
1REM 100 300 S10	10	30	90	10							
1REM 120 350 S12	12	35	100	12							

FOR A.B.S

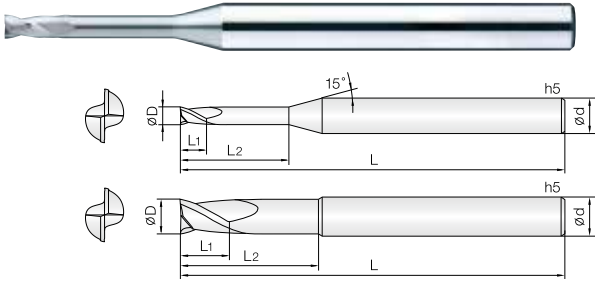

- 아크릴, ABS, 목업, 알루미늄등비철, 비금속 파삭재 가공
- 짧은 날장 채택으로 떨림을 최소화 하였습니다.
- 고속, 고이송 작업시 짧은 날장을 채택하여 공구의 강성이 우수합니다.
- 인선부 강성을 보강하여 날부치핑을 최소화 하였습니다.
- 미립자 조경합금을 채택하여 내마모성이 좋습니다.

#### Endmills for Acryl, A.B.S, Aluminum, non-ferrous and non-metallic materials

- Minimize chattering by short flute design.
- Excellent tool rigidity by short flute design at high speed, feed machining.
- Reinforced edge design for preventing edge chipping.
- Excellent wear resistance by applying fine WC grade.

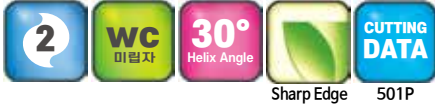

Condition	D Size	D Tolerance	Condition	D Size	D Tolerance
ØD ≠ ød	Ø0.2 ~ 6	+0 ~ -0.01mm	ØD = ød	Ø6	-0.005 ~ -0.015mm

단위 : mm

Order Number	날경 Diameter D	날장 Length of cut L1	유효장 Effective Length L2	전장 Overall Length L	샤크 Shank Dia d	비고	Order Number	날경 Diameter D	날장 Length of cut L1	유효장 Effective Length L2	전장 Overall Length L	샤크 Shank Dia d	비고
2MRE 002 005 S04	0.2	0.3	0.5	40	4		2MRE 015 060 S04	1.5	3	6	50	4	
2MRE 002 010 S04	0.2	0.3	1	40	4		2MRE 015 100 S04	1.5	3	10	50	4	
2MRE 002 015 S04	0.2	0.3	1.5	40	4		2MRE 015 140 S04	1.5	3	14	50	4	
2MRE 002 020 S04	0.2	0.3	2	40	4		2MRE 015 160 S04	1.5	3	16	50	4	
2MRE 003 010 S04	0.3	0.45	1	40	4		2MRE 015 200 S04	1.5	3	20	60	4	
2MRE 003 020 S04	0.3	0.45	2	40	4		2MRE 015 250 S04	1.5	3	25	60	4	
2MRE 003 030 S04	0.3	0.45	3	40	4		2MRE 015 300 S04	1.5	3	30	70	4	
2MRE 003 050 S04	0.3	0.45	5	40	4		2MRE 016 060 S04	1.6	3.2	6	50	4	
2MRE 004 020 S04	0.4	0.6	2	40	4		2MRE 020 080 S04	2	4	8	50	4	
2MRE 004 030 S04	0.4	0.6	3	40	4		2MRE 020 100 S04	2	4	10	50	4	
2MRE 004 040 S04	0.4	0.6	4	40	4		2MRE 020 120 S04	2	4	12	50	4	
2MRE 004 050 S04	0.4	0.6	5	40	4		2MRE 020 140 S04	2	4	14	50	4	
2MRE 004 060 S04	0.4	0.6	6	40	4		2MRE 020 160 S04	2	4	16	50	4	
2MRE 005 020 S04	0.5	1	2	45	4		2MRE 020 180 S04	2	4	18	50	4	
2MRE 005 040 S04	0.5	1	4	45	4		2MRE 020 200 S04	2	4	20	60	4	
2MRE 005 060 S04	0.5	1	6	45	4		2MRE 020 250 S04	2	4	25	60	4	
2MRE 005 080 S04	0.5	1	8	45	4		2MRE 020 300 S04	2	4	30	70	4	
2MRE 005 100 S04	0.5	1	10	45	4		2MRE 020 350 S04	2	4	35	80	4	
2MRE 006 020 S04	0.6	1.2	2	45	4		2MRE 020 400 S04	2	4	40	80	4	
2MRE 006 040 S04	0.6	1.2	4	45	4		2MRE 025 120 S04	2.5	5	12	60	4	
2MRE 006 060 S04	0.6	1.2	6	45	4		2MRE 025 200 S04	2.5	5	20	60	4	
2MRE 006 080 S04	0.6	1.2	8	45	4		2MRE 030 080 S06	3	6	8	70	6	
2MRE 006 100 S04	0.6	1.2	10	45	4		2MRE 030 120 S06	3	6	12	70	6	
2MRE 007 040 S04	0.7	1.4	4	45	4		2MRE 030 160 S06	3	6	16	70	6	
2MRE 007 060 S04	0.7	1.4	6	45	4		2MRE 030 200 S06	3	6	20	70	6	
2MRE 007 080 S04	0.7	1.4	8	45	4		2MRE 030 250 S06	3	6	25	70	6	
2MRE 007 100 S04	0.7	1.4	10	45	4		2MRE 030 300 S06	3	6	30	80	6	
2MRE 008 040 S04	0.8	1.6	4	45	4		2MRE 030 400 S06	3	6	40	90	6	
2MRE 008 060 S04	0.8	1.6	6	45	4		2MRE 030 450 S06	3	6	45	90	6	
2MRE 008 080 S04	0.8	1.6	8	45	4		2MRE 040 120 S06	4	8	12	70	6	
2MRE 008 100 S04	0.8	1.6	10	45	4		2MRE 040 160 S06	4	8	16	70	6	
2MRE 008 120 S04	0.8	1.6	12	45	4		2MRE 040 200 S06	4	8	20	70	6	
2MRE 009 060 S04	0.9	1.8	6	45	4		2MRE 040 250 S06	4	8	25	70	6	
2MRE 009 100 S04	0.9	1.8	10	45	4		2MRE 040 300 S06	4	8	30	70	6	
2MRE 009 120 S04	0.9	1.8	12	45	4		2MRE 040 350 S06	4	8	35	80	6	
2MRE 010 060 S04	1	2	6	50	4		2MRE 040 400 S06	4	8	40	80	6	
2MRE 010 080 S04	1	2	8	50	4		2MRE 040 500 S06	4	8	50	100	6	
2MRE 010 100 S04	1	2	10	50	4		2MRE 050 160 S06	5	10	16	80	6	
2MRE 010 120 S04	1	2	12	50	4		2MRE 050 250 S06	5	10	25	80	6	
2MRE 010 160 S04	1	2	16	50	4		2MRE 050 350 S06	5	10	35	80	6	
2MRE 010 200 S04	1	2	20	60	4		2MRE 060 250 S06	6	12	25	80	6	
2MRE 010 250 S04	1	2	25	60	4		2MRE 060 350 S06	6	12	35	80	6	
2MRE 012 060 S04	1.2	2.4	6	50	4		2MRE 060 500 S06	6	12	50	120	6	
2MRE 012 080 S04	1.2	2.4	8	50	4		2MRE 060 600 S06	6	12	60	120	6	
2MRE 012 100 S04	1.2	2.4	10	50	4								
2MRE 012 120 S04	1.2	2.4	12	50	4								
2MRE 012 160 S04	1.2	2.4	16	50	4								
2MRE 014 060 S04	1.4	2.8	6	50	4								
2MRE 014 100 S04	1.4	2.8	10	50	4								
2MRE 014 160 S04	1.4	2.8	16	50	4								

FOR A.B.S

## 3날 범용 마이크로 리브 엔드밀

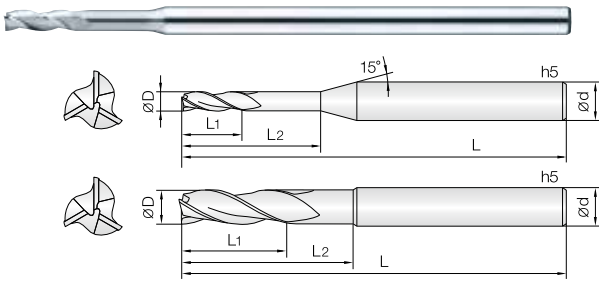

- 아크릴, ABS, 목업, 알루미늄 등 비철, 비금속 피삭재 가공
- 짧은 날장 채택으로 떨림을 최소화 하였습니다
- 고속, 고이송 작업시 짧은 날장을 채택하여 공구의 강성이 우수합니다.
- 인선부 강성을 보강하여 날부치핑을 최소화 하였습니다.
- 미립자 초경합금을 채택하여 내마모성이 좋습니다.

### • Endmills for Acryl, A.B.S, Aluminum, non-ferrous and non-metallic materials

- Minimize chattering by short flute design.
- Excellent tool rigidity by short flute design at high speed, feed machining.
- Reinforced edge design for preventing edge chipping.
- Excellent wear resistance by applying fine WC grade.

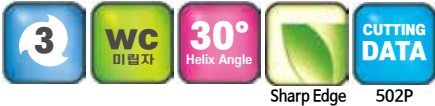

Sharp Edge 502P

Condition	D Size	D Tolerance	Condition	D Size	D Tolerance
ØD ≠ Ød	Ø2 ~ 6	+0 ~ -0.01mm	ØD = Ød	Ø4 ~ 6	-0.005 ~ -0.015mm
	Ø6.1 ~ 25	+0 ~ -0.015mm		Ø8 ~ 12	-0.01 ~ -0.025mm
		Ø16		-0.015 ~ -0.03mm	

단위 : mm

Order Number	날경 Diameter D	날장 Length of cut L1	유효장 Effective Length L2	전장 Overall Length L	샤크 Shank Dia d	비고
3MRE 010 050 S04	1	3	5	70	4	
3MRE 010 100 S04	1	3	10	70	4	
3MRE 010 150 S04	1	3	15	70	4	
3MRE 010 200 S04	1	3	20	70	4	
3MRE 010 250 S04	1	3	25	70	4	
3MRE 015 100 S04	1.5	4.5	10	70	4	
3MRE 015 150 S04	1.5	4.5	15	70	4	
3MRE 015 200 S04	1.5	4.5	20	70	4	
3MRE 015 250 S04	1.5	4.5	25	70	4	
3MRE 015 300 S04	1.5	4.5	30	70	4	
3MRE 020 100 S04	2	6	10	70	4	
3MRE 020 150 S04	2	6	15	70	4	
3MRE 020 200 S04	2	6	20	70	4	
3MRE 020 250 S04	2	6	25	70	4	
3MRE 020 300 S04	2	6	30	70	4	
3MRE 030 200 Ø80	3	15	20	80	3	
3MRE 030 200 S04	3	9	20	80	4	
3MRE 030 300 100	3	15	30	100	3	
3MRE 030 300 S04	3	9	30	80	4	
3MRE 040 200 Ø80	4	12	20	80	4	
3MRE 040 300 100	4	12	30	100	4	
3MRE 060 300 100	6	18	30	100	6	
3MRE 060 400 150	6	18	40	150	6	
3MRE 080 400 120	8	24	40	120	8	
3MRE 080 500 150	8	24	50	150	8	
3MRE 100 500 120	10	30	50	120	10	
3MRE 100 600 150	10	30	60	150	10	
3MRE 120 600 150	12	36	60	150	12	
3MRE 160 700 160	16	54	70	160	16	

FOR A.B.S





단위: mm

Order Number	날경 Diameter D	날장 Length of cut L1	유효장 Effective Length L2	전장 Overall Length L	생크 Shank Dia d	비고	Order Number	날경 Diameter D	날장 Length of cut L1	유효장 Effective Length L2	전장 Overall Length L	생크 Shank Dia d	비고
2MLE 060 250 080	6	25	-	80	6								
2MLE 060 300 080	6	30	-	80	6								
2MLE 060 400 100	6	40	-	100	6								
2MLE 060 400 120	6	40	-	120	6								
2MLE 060 400 150	6	40	-	150	6								
2MLE 080 300 080	8	30	-	80	8								
2MLE 080 350 090	8	35	-	90	8								
2MLE 080 400 100	8	40	-	100	8								
2MLE 080 450 120	8	45	-	120	8								
2MLE 080 450 150	8	45	-	150	8								
2MLE 100 300 080	10	30	-	80	10								
2MLE 100 350 090	10	35	-	90	10								
2MLE 100 400 100	10	40	-	100	10								
2MLE 100 500 120	10	50	-	120	10								
2MLE 100 500 150	10	50	-	150	10								
2MLE 120 300 090	12	30	-	90	12								
2MLE 120 400 100	12	40	-	100	12								
2MLE 120 500 110	12	50	-	110	12								
2MLE 120 550 130	12	55	-	130	12								
2MLE 120 550 150	12	55	-	150	12								
2MLE 160 700 160	16	70	-	160	16								

FOR A.B.S

# 2MEM 2 Flutes End Mills

## 2날 범용 엔드밀

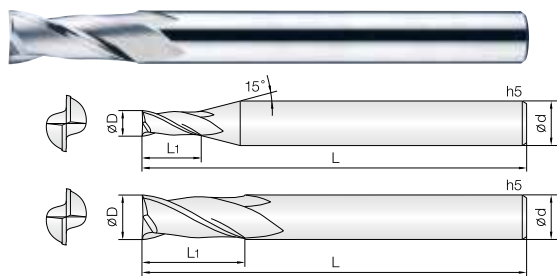

- 일반강, 아크릴, ABS, 목업, 알루미늄 등 비철, 비금속 피삭재 가공
- 인선부 강성을 보강하여 날부치핑을 최소화 하였습니다.
- 균일한 런아웃 공차관리로 공구의 성능을 향상 시켰습니다.
- 미립자 초경합금을 채택하여 내마모성이 좋습니다.

### Endmills for Mild steel, Acryl, A.B.S, Aluminum, non-ferrous and non-metallic materials

- Reinforced edge design for preventing edge chipping.
- Improved tool performance by even run-out and tolerance control.
- Excellent wear resistance by applying fine WC grade.



Condition	D Size	D Tolerance	Condition	D Size	D Tolerance
$\varnothing D \neq \varnothing d$	$\varnothing 0.1 \sim 0.15$	$+0 \sim -0.005\text{mm}$	$\varnothing D = \varnothing d$	$\varnothing 3 \sim 6$	$-0.005 \sim -0.015\text{mm}$
	$\varnothing 0.2 \sim 6$	$+0 \sim -0.01\text{mm}$		$\varnothing 8 \sim 12$	$-0.01 \sim -0.025\text{mm}$
	$\varnothing 7 \sim 12$	$+0 \sim -0.015\text{mm}$			

단위 : mm

Order Number	날경 Diameter D	날장 Length of cut L1	전장 Overall Length L	생크 Shank Dia d	비고
2MEM 001 002 S03	0.1	0.2	40	3	
2MEM 0015 003 S03	0.15	0.3	40	3	
2MEM 002 004 S03	0.2	0.4	40	3	
2MEM 003 006 S03	0.3	0.6	40	3	
2MEM 004 008 S03	0.4	0.8	40	3	
2MEM 005 010 S03	0.5	1	40	3	
2MEM 006 012 S03	0.6	1.2	40	3	
2MEM 007 014 S03	0.7	1.4	40	3	
2MEM 008 016 S03	0.8	1.6	40	3	
2MEM 009 018 S03	0.9	1.8	40	3	
2MEM 010 025 S03	1	2.5	40	3	
2MEM 010 025 S06	1	2.5	40	6	
2MEM 011 025 S03	1.1	2.5	40	3	
2MEM 012 035 S03	1.2	3.5	40	3	
2MEM 013 040 S03	1.3	4	40	3	
2MEM 014 040 S03	1.4	4	40	3	
2MEM 015 040 S03	1.5	4	40	3	
2MEM 015 040 S06	1.5	4	40	6	
2MEM 016 040 S03	1.6	4	40	3	
2MEM 017 050 S03	1.7	5	40	3	
2MEM 018 055 S03	1.8	5.5	40	3	
2MEM 019 060 S03	1.9	6	40	3	
2MEM 020 060 S03	2	6	40	3	
2MEM 020 060 S06	2	6	40	6	
2MEM 025 080 S03	2.5	8	40	3	
2MEM 025 080 S06	2.5	8	40	6	
2MEM 030 080 S03	3	8	45	3	
2MEM 030 080 S06	3	8	45	6	
2MEM 035 100 S06	3.5	10	45	6	
2MEM 040 110 S06	4	11	45	6	
2MEM 045 110 S06	4.5	11	45	6	
2MEM 050 130 S06	5	13	50	6	
2MEM 060 130 S06	6	13	50	6	
2MEM 070 160 S08	7	16	60	8	
2MEM 080 190 S08	8	19	60	8	
2MEM 090 190 S10	9	19	70	10	
2MEM 100 220 S10	10	22	70	10	
2MEM 120 260 S12	12	26	75	12	

Order Number	날경 Diameter D	날장 Length of cut L1	전장 Overall Length L	생크 Shank Dia d	비고

FOR A.B.S

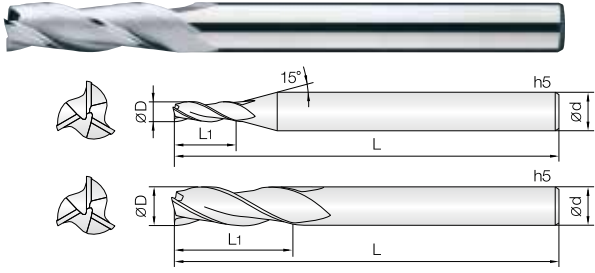

- 일반강, 아크릴, ABS, 목업, 알루미늄 등 비철, 비금속 피삭재 가공
- 인선부 강성을 보강하여 날부치핑을 최소화 하였습니다.
- 짧은 날강 채택으로 떨림을 최소화 하였습니다.
- 미립자 초경합금을 채택하여 내마모성이 좋습니다.

**• Endmills for Mild steel, Acryl, A.B.S, Aluminum, non-ferrous and non-metallic materials**

- Reinforced edge design for preventing edge chipping.
- Minimize chattering by short flute design
- Excellent wear resistance by applying fine WC grade.

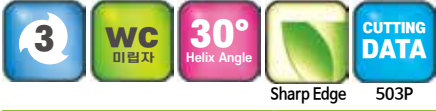

Condition	D Size	D Tolerance	Condition	D Size	D Tolerance
$\varnothing D \neq \varnothing d$	$\varnothing 0.3 \sim 6$	$+0 \sim -0.01 \text{mm}$	$\varnothing D = \varnothing d$	$\varnothing 4 \sim 6$	$-0.005 \sim -0.015 \text{mm}$

단위 : mm

Order Number	날경 Diameter D	날강 Length of cut L1	전강 Overall Length L	생크 Shank Dia d	비고
3MEM 003 008 S04	0.3	0.8	40	4	
3MEM 003 012 S04	0.3	1.2	40	4	
3MEM 004 010 S04	0.4	1	40	4	
3MEM 004 015 S04	0.4	1.5	40	4	
3MEM 005 013 S04	0.5	1.3	40	4	
3MEM 005 020 S04	0.5	2	45	4	
3MEM 006 015 S04	0.6	1.5	40	4	
3MEM 006 024 S04	0.6	2.4	45	4	
3MEM 007 018 S04	0.7	1.8	40	4	
3MEM 007 028 S04	0.7	2.8	45	4	
3MEM 008 020 S04	0.8	2	40	4	
3MEM 008 032 S04	0.8	3.2	45	4	
3MEM 009 025 S04	0.9	2.5	40	4	
3MEM 009 036 S04	0.9	3.6	45	4	
3MEM 010 025 S04	1	2.5	40	4	
3MEM 010 040 S04	1	4	45	4	
3MEM 010 060 S04	1	6	50	4	
3MEM 012 030 S04	1.2	3	40	4	
3MEM 012 050 S04	1.2	5	40	4	
3MEM 012 070 S04	1.2	7	50	4	
3MEM 015 040 S04	1.5	4	40	4	
3MEM 015 060 S04	1.5	6	40	4	
3MEM 015 090 S04	1.5	9	60	4	
3MEM 020 050 S04	2	5	40	4	
3MEM 020 080 S04	2	8	50	4	
3MEM 020 100 S04	2	10	60	4	
3MEM 025 060 S04	2.5	6	45	4	
3MEM 025 100 S04	2.5	10	50	4	
3MEM 025 150 S04	2.5	15	60	4	
3MEM 030 080 S04	3	8	50	4	
3MEM 030 120 S04	3	12	60	4	
3MEM 030 150 S04	3	15	80	4	
3MEM 040 100 S04	4	10	50	4	
3MEM 040 150 S04	4	15	80	4	
3MEM 060 200 S06	6	20	80	6	
3MEM 060 300 S06	6	30	110	6	

Order Number	날경 Diameter D	날강 Length of cut L1	전강 Overall Length L	생크 Shank Dia d	비고



### 초경2날 고경도 가공용 HH헬릭스 볼 인서트

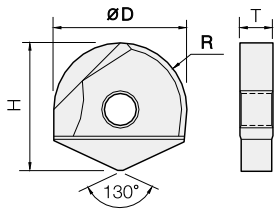
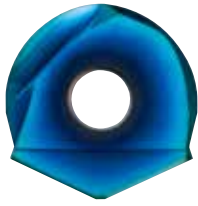

- 고경도강(HRc62이하), 프리하든강 계열의 고정밀 가공 인서트, 그래파이트
- TISIN-S 코팅 처리하여 인선부 내마모성이 탁월합니다.
- 헬릭스 형상의 인선부를 설계하여, 절삭력이 향상되었습니다.
- 볼 형상을 날부 치핑이 적도록 설계하였습니다.
- 항절력이 높은 초미립자 초경합금(0.3µm)을 채택, 인서트의 파손을 최소화 하였습니다.

#### Ball Inserts for hardened steels (~HRc62), pre-hardened and graphite materials

- Optimum for wear resistance by TISIN-S coating.
- Maximize cutting force by applying the new helix edge design.
- Designed for minimizing edge chipping by ball shape.
- Minimize fracturing by ultra fine(0.3µm) WC grade.



D Size	D Tolerance
Ø 10 ~ 13	+0 ~ -0.01mm
Ø 16 ~ 30	+0 ~ -0.02mm

단위 : mm

Order Number	날경 Diameter R × D	높이 Height H	두께 Thickness T
2HHINB 100	5R X 10	12.1	2.7
2HHINB 110	5.5R X 11	12.6	2.7
2HHINB 120	6R X 12	14.6	3.2
2HHINB 130	6.5R X 13	15.1	3.2
2HHINB 160	8R X 16	16.5	4.2
2HHINB 170	8.5R X 17	17	4.2
2HHINB 200	10R X 20	20.4	5.2

Order Number	날경 Diameter R × D	높이 Height H	두께 Thickness T
2HHINB 210	10.5R X 21	20.9	5.2
2HHINB 250	12.5R X 25	24.1	6.2
2HHINB 260	13R X 26	24.6	6.2
2HHINB 300	15R X 30	29.1	7.2
New 2HHINB 320	16R X 32	30.4	7.2
New 2HHINB 330	16.5R X 33	30.4	7.2

### 초경 2날 고경도 가공용 헬릭스 코너R 인서트

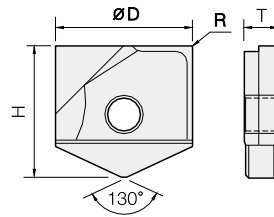

- 고경도강(HRc62이하), 프리하든강 계열의 고정밀 가공 인서트, 그래파이트
- TISIN-S 코팅 처리하여 인선부 내마모성이 탁월 합니다.
- 헬릭스 형상의 인선부를 설계하여, 절삭력이 향상 되었습니다.
- 볼 형상을 날부 치핑이 적도록 설계 하였습니다.
- 항절력이 높은 초미립자 초경합금(0.3µm)을 채택, 인서트의 파손을 최소화 하였습니다.

#### Endmills for Mild steel, Acryl, A.B.S, Aluminum, non-ferrous and non-metallic materials

- Optimum for wear resistance by TISIN-S coating.
- Maximize cutting force by applying the new helix edge design.
- Designed for minimizing edge chipping by ball shape.
- Minimize fracturing by ultra fine(0.3µm) WC grade.



D Size	D Tolerance
Ø 10 ~ 13	+0 ~ -0.01mm
Ø 16 ~ 30	+0 ~ -0.02mm

단위 : mm

Order Number	날경 Diameter D × R	높이 Height H	두께 Thickness T
2HHINC 100 005	10 X R0.5	12.1	2.7
2HHINC 100 010	10 X R1	12.1	2.7
2HHINC 110 005	11 X R0.5	12.6	2.7
2HHINC 110 010	11 X R1	12.6	2.7
2HHINC 120 005	12 X R0.5	14.6	3.2
2HHINC 120 010	12 X R1	14.6	3.2
2HHINC 120 020	12 X R2	14.6	3.2
2HHINC 130 005	13 X R0.5	15.1	3.2
2HHINC 130 010	13 X R1	15.1	3.2
2HHINC 130 020	13 X R2	15.1	3.2
2HHINC 160 005	16 X R0.5	16.5	4.2
2HHINC 160 010	16 X R1	16.5	4.2
2HHINC 160 020	16 X R2	16.5	4.2
2HHINC 170 005	17 X R0.5	17	4.2
2HHINC 170 010	17 X R1	17	4.2
2HHINC 170 020	17 X R2	17	4.2
2HHINC 200 005	20 X R0.5	20.4	5.2
2HHINC 200 010	20 X R1	20.4	5.2
2HHINC 200 020	20 X R2	20.4	5.2

Order Number	날경 Diameter D × R	높이 Height H	두께 Thickness T
2HHINC 210 005	21 X R0.5	20.9	5.2
2HHINC 210 010	21 X R1	20.9	5.2
2HHINC 210 020	21 X R2	20.9	5.2
2HHINC 250 005	25 X R0.5	24.1	6.2
2HHINC 250 010	25 X R1	24.1	6.2
2HHINC 250 020	25 X R2	24.1	6.2
2HHINC 260 005	26 X R0.5	24.6	6.2
2HHINC 260 010	26 X R1	24.6	6.2
2HHINC 260 020	26 X R2	24.6	6.2
2HHINC 300 005	30 X R0.5	29.1	7.2
2HHINC 300 010	30 X R1	29.1	7.2
2HHINC 300 020	30 X R2	29.1	7.2
New 2HHINC 320 005	32 X R0.5	30.4	7.2
New 2HHINC 320 010	32 X R1	30.4	7.2
New 2HHINC 320 020	32 X R2	30.4	7.2
New 2HHINC 330 005	33 X R0.5	30.4	7.2
New 2HHINC 330 010	33 X R1	30.4	7.2
New 2HHINC 330 020	33 X R2	30.4	7.2



## 2 Flutes JJ Carbide Ball Inserts for Hardened Steels

### 초경 2날 고경도 가공용 제이제이 볼 인서트

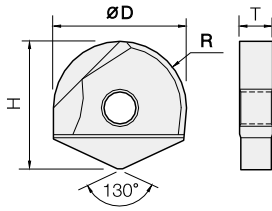
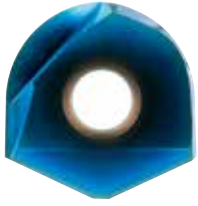

- 고경도강(HRC62이하), 프리하든강 계열의 고정밀 가공 인서트, 그래파이트
- TISIN-S 코팅 처리하여 인선부 내마모성이 탁월합니다.
- 볼 형상을 날부 치핑이 적도록 설계하였습니다.
- 항절력이 높은 초미립자 초경합금(0.3 $\mu$ m)을 채택, 인서트의 파손을 최소화 하였습니다.

#### Ball Inserts for hardened steel(~HRC62), pre-hardened and graphite materials

- Optimum for wear resistance by TISIN-S coating.
- Designed for minimizing edge chipping by ball shape.
- Minimize fracturing by ultra fine(0.3 $\mu$ m) WC grade.

5 ~ 6.5R    8 ~ 15R    5 ~ 15R    504P

D Size	D Tolerance
Ø 10 ~ 13	+0 ~ -0.01mm
Ø 16 ~ 30	+0 ~ -0.02mm

단위 : mm

Order Number	날경 Diameter R × D	높이 Height H	두께 Thickness T	Order Number	날경 Diameter R × D	높이 Height H	두께 Thickness T
2JJINB 100	5R X 10	12.1	2.7	2JJINB 210	10.5R X 21	20.9	5.2
2JJINB 110	5.5R X 11	12.6	2.7	2JJINB 250	12.5R X 25	24.1	6.2
2JJINB 120	6R X 12	14.6	3.2	2JJINB 260	13R X 26	24.6	6.2
2JJINB 130	6.5R X 13	15.1	3.2	2JJINB 300	15R X 30	29.1	7.2
2JJINB 160	8R X 16	16.5	4.2	New 2JJINB 320	16R X 32	30.4	7.2
2JJINB 170	8.5R X 17	17	4.2	New 2JJINB 330	16.5R X 33	30.4	7.2
2JJINB 200	10R X 20	20.4	5.2				



## 2 Flutes JJ CarbideCorner Radius Inserts for Hardened Steels

### 초경 2날 고경도 가공용 제이제이 코너R 인서트

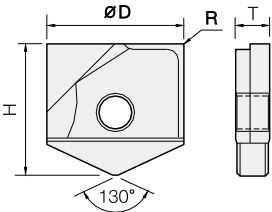
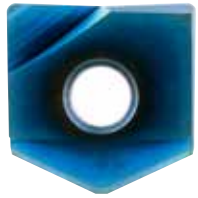

- 고경도강(HRC62이하), 프리하든강 계열의 고정밀 가공인서트, 그래파이트
- TISIN-S 코팅 처리하여 인선부 내마모성이 탁월합니다.
- 볼 형상을 날부 치핑이 적도록 설계하였습니다.
- 항절력이 높은 초미립자 초경합금(0.3 $\mu$ m)을 채택, 인서트의 파손을 최소화 하였습니다.

#### Ball Inserts for hardened steel(~HRC62), pre-hardened and graphite materials

- Optimum for wear resistance by TISIN-S coating.
- Designed for minimizing edge chipping by ball shape.
- Minimize fracturing by ultra fine(0.3 $\mu$ m) WC grade.

0.5 ~ 2R    Ø10 ~ 30    504P

D Size	D Tolerance
Ø 10 ~ 13	+0 ~ -0.01mm
Ø 16 ~ 30	+0 ~ -0.02mm

단위 : mm

Order Number	날경 Diameter D × R	높이 Height H	두께 Thickness T	Order Number	날경 Diameter D × R	높이 Height H	두께 Thickness T
2JJINC 100 005	10 X R0.5	12.1	2.7	2JJINC 210 005	21 X R0.5	20.9	5.2
2JJINC 100 010	10 X R1	12.1	2.7	2JJINC 210 010	21 X R1	20.9	5.2
2JJINC 110 005	11 X R0.5	12.6	2.7	2JJINC 210 020	21 X R2	20.9	5.2
2JJINC 110 010	11 X R1	12.6	2.7	2JJINC 250 005	25 X R0.5	24.1	6.2
2JJINC 120 005	12 X R0.5	14.6	3.2	2JJINC 250 010	25 X R1	24.1	6.2
2JJINC 120 010	12 X R1	14.6	3.2	2JJINC 250 020	25 X R2	24.1	6.2
2JJINC 120 020	12 X R2	14.6	3.2	2JJINC 260 005	26 X R0.5	24.6	6.2
2JJINC 130 005	13 X R0.5	15.1	3.2	2JJINC 260 010	26 X R1	24.6	6.2
2JJINC 130 010	13 X R1	15.1	3.2	2JJINC 260 020	26 X R2	24.6	6.2
2JJINC 130 020	13 X R2	15.1	3.2	2JJINC 300 005	30 X R0.5	29.1	7.2
2JJINC 160 005	16 X R0.5	16.5	4.2	2JJINC 300 010	30 X R1	29.1	7.2
2JJINC 160 010	16 X R1	16.5	4.2	2JJINC 300 020	30 X R2	29.1	7.2
2JJINC 160 020	16 X R2	16.5	4.2	New 2JJINC 320 005	32 X R0.5	30.4	7.2
2JJINC 170 005	17 X R0.5	17	4.2	New 2JJINC 320 010	32 X R1	30.4	7.2
2JJINC 170 010	17 X R1	17	4.2	New 2JJINC 320 020	32 X R2	30.4	7.2
2JJINC 170 020	17 X R2	17	4.2	New 2JJINC 330 005	33 X R0.5	30.4	7.2
2JJINC 200 005	20 X R0.5	20.4	5.2	New 2JJINC 330 010	33 X R1	30.4	7.2
2JJINC 200 010	20 X R1	20.4	5.2	New 2JJINC 330 020	33 X R2	30.4	7.2
2JJINC 200 020	20 X R2	20.4	5.2				

INSERT

### 초경 2날 범용 헬릭스 볼 인서트

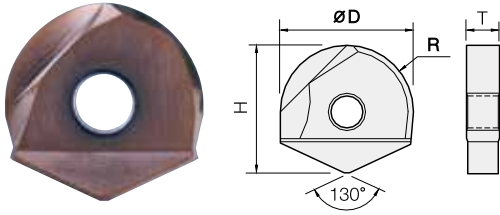

- 고경도강(HRc52이하), 프리하든강 계열의 고정밀 가공 인서트, 그래파이트
- TISIN 코팅 처리하여 날부 치핑이 적도록 설계하였습니다.
- 헬릭스 형상의 인선부를 설계하여, 절삭력이 향상되었습니다.
- 항절력이 높은 미립자 초경합금을 채택, 인서트의 파손을 최소화 하였습니다.

#### Ball Inserts for hardened steels (~HRc52), pre-hardened and graphite materials

- Designed for minimizing edge chipping by TISIN coating.
- Maximize cutting force by applying the new helix edge design.
- Minimize fracturing by high TRS fine WC grade.



D Size	D Tolerance
Ø 10 ~ 13	+0 ~ -0.01mm
Ø 16 ~ 30	+0 ~ -0.02mm

단위 : mm

Order Number	날경 Diameter R × D	높이 Height H	두께 Thickness T
2GINB 100	5R X 10	12.1	2.7
2GINB 110	5.5R X 11	12.6	2.7
2GINB 120	6R X 12	14.6	3.2
2GINB 130	6.5R X 13	15.1	3.2
2GINB 160	8R X 16	16.5	4.2
2GINB 170	8.5R X 17	17	4.2
2GINB 200	10R X 20	20.4	5.2

Order Number	날경 Diameter R × D	높이 Height H	두께 Thickness T
2GINB 210	10.5R X 21	20.9	5.2
2GINB 250	12.5R X 25	24.1	6.2
2GINB 260	13R X 26	24.6	6.2
2GINB 300	15R X 30	29.1	7.2
New 2GINB 320	16R X 32	30.4	7.2
New 2GINB 330	16.5R X 33	30.4	7.2

### 초경 2날 범용 헬릭스 코너R 인서트

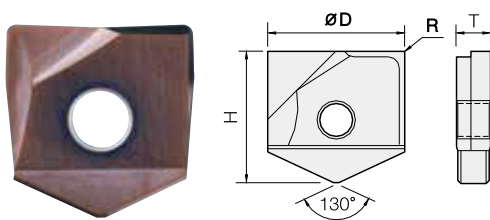

- 고경도강(HRc52이하), 프리하든강 계열의 고정밀 가공 인서트, 그래파이트
- TISIN 코팅 처리하여 날부 치핑이 적도록 설계하였습니다.
- 헬릭스 형상의 인선부를 설계하여, 절삭력이 향상되었습니다.
- 항절력이 높은 미립자 초경합금을 채택, 인서트의 파손을 최소화 하였습니다.

#### Ball Inserts for hardened steels (~HRc52), pre-hardened and graphite materials.

- Designed for minimizing edge chipping by TISIN coating.
- Maximize cutting force by applying the new helix edge design.
- Minimize fracturing by high TRS fine WC grade.



D Size	D Tolerance
Ø 10 ~ 13	+0 ~ -0.01mm
Ø 16 ~ 30	+0 ~ -0.02mm

단위 : mm

Order Number	날경 Diameter D × R	높이 Height H	두께 Thickness T
2GINC 100 005	10 X R0.5	12.1	2.7
2GINC 100 010	10 X R1	12.1	2.7
2GINC 110 005	11 X R0.5	12.6	2.7
2GINC 110 010	11 X R1	12.6	2.7
2GINC 120 005	12 X R0.5	14.6	3.2
2GINC 120 010	12 X R1	14.6	3.2
2GINC 120 020	12 X R2	14.6	3.2
2GINC 130 005	13 X R0.5	15.1	3.2
2GINC 130 010	13 X R1	15.1	3.2
2GINC 130 020	13 X R2	15.1	3.2
2GINC 160 005	16 X R0.5	16.5	4.2
2GINC 160 010	16 X R1	16.5	4.2
2GINC 160 020	16 X R2	16.5	4.2
2GINC 170 005	17 X R0.5	17	4.2
2GINC 170 010	17 X R1	17	4.2
2GINC 170 020	17 X R2	17	4.2
2GINC 200 005	20 X R0.5	20.4	5.2
2GINC 200 010	20 X R1	20.4	5.2
2GINC 200 020	20 X R2	20.4	5.2

Order Number	날경 Diameter D × R	높이 Height H	두께 Thickness T
2GINC 210 005	21 X R0.5	20.9	5.2
2GINC 210 010	21 X R1	20.9	5.2
2GINC 210 020	21 X R2	20.9	5.2
2GINC 250 005	25 X R0.5	24.1	6.2
2GINC 250 010	25 X R1	24.1	6.2
2GINC 250 020	25 X R2	24.1	6.2
2GINC 260 005	26 X R0.5	24.6	6.2
2GINC 260 010	26 X R1	24.6	6.2
2GINC 260 020	26 X R2	24.6	6.2
2GINC 300 005	30 X R0.5	29.1	7.2
2GINC 300 010	30 X R1	29.1	7.2
2GINC 300 020	30 X R2	29.1	7.2
New 2GINC 320 005	32 X R0.5	30.4	7.2
New 2GINC 320 010	32 X R1	30.4	7.2
New 2GINC 320 020	32 X R2	30.4	7.2
New 2GINC 330 005	33 X R0.5	30.4	7.2
New 2GINC 330 010	33 X R1	30.4	7.2
New 2GINC 330 020	33 X R2	30.4	7.2





2Flutes Diamond Coated Ball Inserts for Graphite

초경 2날 흑연 가공용 다이아몬드 코팅 볼 인서트

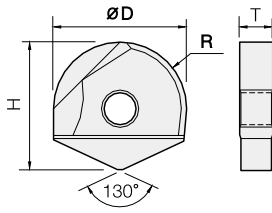
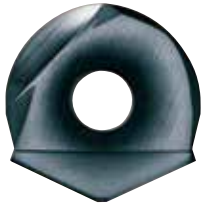

- 그래파이트(흑연) 가공 전용 인서트
- CVD 순수 다이아몬드 코팅을 적용하여 내마모성이 우수합니다.
- 헬릭스 형상의 인선부를 설계하여, 절삭력이 향상되었습니다.
- Inserts for graphite milling
- Excellent wear resistance by applying qualified CVD diamond coating.
- Maximize cutting force by applying the new helix edge design.

5 ~ 6.5R    8 ~ 15R    5 ~ 15R    506P

D Size	D Tolerance
Ø 10 ~ 13	+0 ~ -0.01mm
Ø 16 ~ 30	+0 ~ -0.02mm

단위 : mm

Order Number	날경 Diameter R × D	높이 Height H	두께 Thickness T	Order Number	날경 Diameter R × D	높이 Height H	두께 Thickness T
2DINB 100	5R X 10	12.1	2.7	2DINB 210	10.5R X 21	20.9	5.2
2DINB 110	5.5R X 11	12.6	2.7	2DINB 250	12.5R X 25	24.1	6.2
2DINB 120	6R X 12	14.6	3.2	2DINB 260	13R X 26	24.6	6.2
2DINB 130	6.5R X 13	15.1	3.2	2DINB 300	15R X 30	29.1	7.2
2DINB 160	8R X 16	16.5	4.2				
2DINB 170	8.5R X 17	17	4.2				
2DINB 200	10R X 20	20.4	5.2				



2Flutes Diamond Coated Corner Radius Inserts for Graphite

초경 2날 흑연 가공용 다이아몬드 코팅 코너 R 인서트

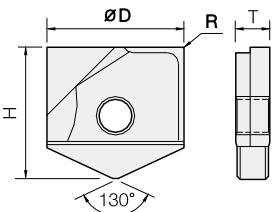

- 그래파이트(흑연) 가공 전용 인서트
- CVD 순수 다이아몬드 코팅을 적용하여 내마모성이 우수합니다.
- 헬릭스 형상의 인선부를 설계하여, 절삭력이 향상되었습니다.
- Inserts for graphite milling
- Excellent wear resistance by applying qualified CVD diamond coating.
- Maximize cutting force by applying the new helix edge design.

0.5 ~ 2R    Ø10 ~ 30    506P

D Size	D Tolerance
Ø 10 ~ 13	+0 ~ -0.01mm
Ø 16 ~ 30	+0 ~ -0.02mm

단위 : mm

Order Number	날경 Diameter D × R	높이 Height H	두께 Thickness T	Order Number	날경 Diameter D × R	높이 Height H	두께 Thickness T
2DINC 100 005	10 X R0.5	12.1	2.7	2DINC 200 005	20 X R0.5	20.4	5.2
2DINC 100 010	10 X R1	12.1	2.7	2DINC 200 010	20 X R1	20.4	5.2
2DINC 110 005	11 X R0.5	12.6	2.7	2DINC 200 020	20 X R2	20.4	5.2
2DINC 110 010	11 X R1	12.6	2.7	2DINC 210 005	21 X R0.5	20.9	5.2
2DINC 120 005	12 X R0.5	14.6	3.2	2DINC 210 010	21 X R1	20.9	5.2
2DINC 120 010	12 X R1	14.6	3.2	2DINC 210 020	21 X R2	20.9	5.2
2DINC 120 020	12 X R2	14.6	3.2	2DINC 250 005	25 X R0.5	24.1	6.2
2DINC 130 005	13 X R0.5	15.1	3.2	2DINC 250 010	25 X R1	24.1	6.2
2DINC 130 010	13 X R1	15.1	3.2	2DINC 250 020	25 X R2	24.1	6.2
2DINC 130 020	13 X R2	15.1	3.2	2DINC 260 005	26 X R0.5	24.6	6.2
2DINC 160 005	16 X R0.5	16.5	4.2	2DINC 260 010	26 X R1	24.6	6.2
2DINC 160 010	16 X R1	16.5	4.2	2DINC 260 020	26 X R2	24.6	6.2
2DINC 160 020	16 X R2	16.5	4.2	2DINC 300 005	30 X R0.5	29.1	7.2
2DINC 170 005	17 X R0.5	17	4.2	2DINC 300 010	30 X R1	29.1	7.2
2DINC 170 010	17 X R1	17	4.2	2DINC 300 020	30 X R2	29.1	7.2
2DINC 170 020	17 X R2	17	4.2				

INSERT

# 4SFJB

4Flutes JJ Carbide Helix Ball Shrink-fit Inserts for Hardened steels

## 초경 4날 열박음 고경도 가공용 제이제이 볼 인서트

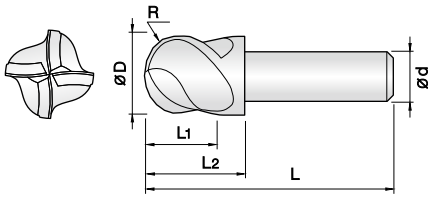
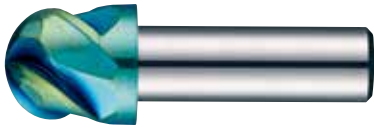

- 고경도강(HRc52~62), 프리하든강 계열의 고정밀 가공 열박음 인서트
- TISIN-S 코팅 처리하여 인선부 내마모성이 탁월합니다.
- 열박음 홀더 체결시 높은 파지력과 뛰어난 동심도 유지가 가능합니다.
- 3회 이상의 재연마가 가능하여 매우 경제적입니다.
- 항절력이 높은 미립자 초경합금(0.4 $\mu$ m)을 채택, 인서트의 파손을 최소화 하였습니다.

- Shrink fit inserts for hardened steel (HRc52~62), pre-hardened steels
- Optimum for wear resistance on the edge by TISIN-S coating.
- Excellent holding power and concentricity keeping are available by shrink fitting holder.
- It is very economical because regrinding is available more than three times.
- Minimize fracturing by high TRS fine (0.4 $\mu$ m) WC grade.

4

WC  
미립자

TISIN-S  
Coating

R  
 $\pm 0.01$

R  
 $\pm 0.015$

45°  
Helix Angle

CUTTING  
DATA

5 ~ 6.5R    8 ~ 10.5R    506P

D Size	D Tolerance
Ø 10 ~ 12	-0.005 ~ -0.015mm
Ø 13 ~ 21	-0.01 ~ -0.02mm

단위 : mm

Order Number	날경 Diameter R x D	날장 Length of cut L1	유효장 Effective Length L2	전장 Overall Length L	샙크 Shank Dia d	Order Number	날경 Diameter R x D	날장 Length of cut L1	유효장 Effective Length L2	전장 Overall Length L	샙크 Shank Dia d
4SFJB 100 085 S06	5R X 10	8.5	12	37	6						
4SFJB 110 085 S06	5.5R X 11	8.5	12	37	6						
4SFJB 120 090 S06	6R X 12	9	13	38	6						
4SFJB 130 090 S06	6.5R X 13	9	13	38	6						
4SFJB 160 120 S10	8R X 16	12	17	48	10						
4SFJB 170 120 S10	8.5R X 17	12	17	48	10						
4SFJB 200 150 S12	10R X 20	15	21	54	12						
4SFJB 210 150 S12	10.5R X 21	15	21	54	12						

# 4SFJC

4Flutes JJ Carbide Helix Corner Radius Shrink-fit Inserts for Hardened steel

## 초경 4날 열박음 고경도 가공용 제이제이 코너R 인서트

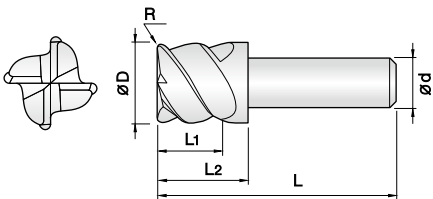
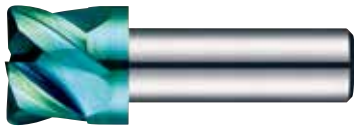

- 고경도강(HRc52~62), 프리하든강 계열의 고정밀 가공 열박음 인서트
- TISIN-S 코팅 처리하여 인선부 내마모성이 탁월합니다.
- 열박음 홀더 체결시 높은 파지력과 뛰어난 동심도 유지가 가능합니다.
- 3회 이상의 재연마가 가능하여 매우 경제적입니다.
- 항절력이 높은 미립자 초경합금(0.4 $\mu$ m)을 채택, 인서트의 파손을 최소화 하였습니다.

- Shrink fit inserts for hardened steel (HRc52~62), pre-hardened steels.
- Optimum for wear resistance on the edge by TISIN-S coating.
- Excellent holding power and concentricity keeping are available by shrink fitting holder.
- It is very economical because regrinding is available more than three times.
- Minimize fracturing by high TRS fine (0.4 $\mu$ m) WC grade.

4

WC  
미립자

TISIN-S  
Coating

R  
 $\pm 0.005$

R  
 $\pm 0.01$

45°  
Helix Angle

CUTTING  
DATA

R0.3 ~ 0.5    R1    507P

D Size	D Tolerance
Ø 10 ~ 12	-0.005 ~ -0.015mm
Ø 13 ~ 21	-0.01 ~ -0.02mm

단위 : mm

Order Number	날경 Diameter D x R	날장 Length of cut L1	유효장 Effective Length L2	전장 Overall Length L	샙크 Shank Dia d	Order Number	날경 Diameter D x R	날장 Length of cut L1	유효장 Effective Length L2	전장 Overall Length L	샙크 Shank Dia d
4SFJC 100 003 085	10 X R0.3	8.5	12	37	6	4SFJC 130 010 090	13 X R1	9	13	38	6
4SFJC 100 005 085	10 X R0.5	8.5	12	37	6	4SFJC 160 005 120	16 X R0.5	12	17	48	10
4SFJC 100 010 085	10 X R1	8.5	12	37	6	4SFJC 160 010 120	16 X R1	12	17	48	10
4SFJC 110 003 085	11 X R0.3	8.5	12	37	6	4SFJC 170 005 120	17 X R0.5	12	17	48	10
4SFJC 110 005 085	11 X R0.5	8.5	12	37	6	4SFJC 170 010 120	17 X R1	12	17	48	10
4SFJC 110 010 085	11 X R1	8.5	12	37	6	4SFJC 200 005 150	20 X R0.5	15	21	54	12
4SFJC 120 003 090	12 X R0.3	9	13	38	6	4SFJC 200 010 150	20 X R1	15	21	54	12
4SFJC 120 005 090	12 X R0.5	9	13	38	6	4SFJC 210 005 150	21 X R0.5	15	21	54	12
4SFJC 120 010 090	12 X R1	9	13	38	6	4SFJC 210 010 150	21 X R1	15	21	54	12
4SFJC 130 003 090	13 X R0.3	9	13	38	6						
4SFJC 130 005 090	13 X R0.5	9	13	38	6						

# 6~12SFJC

6~12Flutes JJ Carbide Helix Corner Radius Shrink-fit Inserts for Hardened steels

## 초경 6~12날 열박음 고경도 가공용 제이제이 코너R 인서트

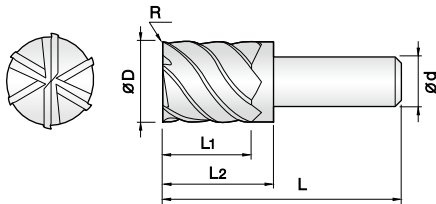

- 고경도강 (HRc52~62), 프리하드강 계열의 고정밀 가공 열박음 인서트
- TISIN-S 코팅 처리하여 인선부 내마모성이 탁월합니다.
- 6~12날까지 적용하여, 고속 가공을 실현하였습니다.
- 열박음 홀더 체결시 높은 파지력과 뛰어난 동심도 유지가 가능합니다.
- 3회 이상의 재연마가 가능하여 매우 경제적입니다.
- 항절력이 높은 미립자 초경합금 (0.4 $\mu$ m)을 채택, 인서트의 파손을 최소화 하였습니다.

### Shrink fit inserts for hardened steels (HRc52~62), pre-hardened steels

- Optimum for wear resistance on the edge by TISIN-S coating.
- High speed milling process is available with multiple 6-12 flutes.
- Excellent holding power and concentricity keeping are available by shrink fitting holder.
- It is very economical because regrinding is available more than three times.
- Minimize fracturing by high TRS fine (0.4 $\mu$ m) WC grade.

6 ~ 12
WC 미립자
TISIN-S Coating
R0.3 ~ 0.5
R1
45° Helix Angle
CUTTING DATA

D Size	D Tolerance
Ø 10 ~ 12	-0.005 ~ -0.015mm
Ø 13 ~ 21	-0.01 ~ -0.02mm

Order Number	날경 Diameter D×R	날장 Length of cut L1	유효장 Effective Length L2	전장 Overall Length L	생크 Shank Dia d	Order Number	날경 Diameter D×R	날장 Length of cut L1	유효장 Effective Length L2	전장 Overall Length L	생크 Shank Dia d
6SFJC 100 003 085	10 X R0.3	8.5	12	37	6	8SFJC 130 010 090	13 X R1	9	13	38	6
6SFJC 100 005 085	10 X R0.5	8.5	12	37	6	10SFJC 160 005 120	16 X R0.5	12	17	48	10
6SFJC 100 010 085	10 X R1	8.5	12	37	6	10SFJC 160 010 120	16 X R1	12	17	48	10
6SFJC 110 003 085	11 X R0.3	8.5	12	37	6	10SFJC 170 005 120	17 X R0.5	12	17	48	10
6SFJC 110 005 085	11 X R0.5	8.5	12	37	6	10SFJC 170 010 120	17 X R1	12	17	48	10
6SFJC 110 010 085	11 X R1	8.5	12	37	6	12SFJC 200 005 150	20 X R0.5	15	21	54	12
8SFJC 120 003 090	12 X R0.3	9	13	38	6	12SFJC 200 010 150	20 X R1	15	21	54	12
8SFJC 120 005 090	12 X R0.5	9	13	38	6	12SFJC 210 005 150	21 X R0.5	15	21	54	12
8SFJC 120 010 090	12 X R1	9	13	38	6	12SFJC 210 010 150	21 X R1	15	21	54	12
8SFJC 130 003 090	13 X R0.3	9	13	38	6						
8SFJC 130 005 090	13 X R0.5	9	13	38	6						

단위 : mm

# 4SFDB

4Flutes Diamond Coated Helix Ball Shrink-fit Inserts for Graphites

## 초경 4날 열박음 흑연가공용 다이아몬드 코팅 볼 인서트

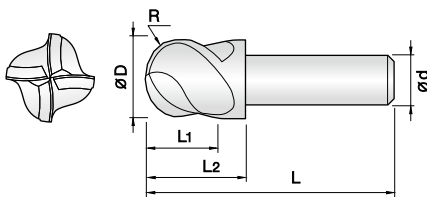

- 그래파이트(흑연) 가공 전용 인서트
- CVD 순수 다이아몬드 코팅을 적용하여 내마모성이 우수합니다.
- 헬릭스 형상의 인선부를 설계하여, 절삭력이 향상되었습니다.
- 열박음 홀더 체결시 높은 파지력과 뛰어난 동심도 유지가 가능합니다.

### Inserts for graphite milling

- Excellent wear resistance by applying qualified CVD diamond coating.
- Maximize cutting force by applying the new helix edge design.
- Excellent holding power and concentricity keeping are available by shrink fitting holder.

4
WC 미립자
DIA. Coating
R ±0.01
R ±0.015
45° Helix Angle
CUTTING DATA

D Size	D Tolerance
Ø 10 ~ 12	+0 ~ -0.02mm
Ø 13 ~ 21	+0 ~ -0.025mm

Order Number	날경 Diameter R×D	날장 Length of cut L1	유효장 Effective Length L2	전장 Overall Length L	생크 Shank Dia d	Order Number	날경 Diameter R×D	날장 Length of cut L1	유효장 Effective Length L2	전장 Overall Length L	생크 Shank Dia d
4SFDB 100 085 S06	5R X 10	8.5	12	37	6						
4SFDB 110 085 S06	5.5R X 11	8.5	12	37	6						
4SFDB 120 090 S06	6R X 12	9	13	38	6						
4SFDB 130 090 S06	6.5R X 13	9	13	38	6						
4SFDB 160 120 S10	8R X 16	12	17	48	10						
4SFDB 170 120 S10	8.5R X 17	12	17	48	10						
4SFDB 200 150 S12	10R X 20	15	21	54	12						
4SFDB 210 150 S12	10.5R X 21	15	21	54	12						

단위 : mm

INSERT

# 4SFDC

4Flutes Diamond Coated Helix Corner Radius Shrink-fit Inserts for Graphite

## 초경 4날 열박음 흑연가공용 다이아몬드 코팅 코너 R 인서트

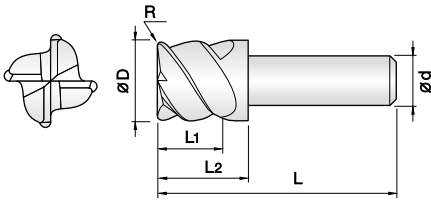

- **그래파이트(흑연) 가공 전용 인서트**
- CVD 순수 다이아몬드 코팅을 적용하여 내마모성이 우수합니다.
- 헬릭스 형상의 인선부를 설계하여, 절삭력이 향상되었습니다.
- 열박음 홀더 체결시 높은 파지력과 뛰어난 동심도 유지가 가능합니다.

- **Inserts for graphite milling**
- Excellent wear resistance by applying qualified CVD diamond coating.
- Maximize cutting force by applying the new helix edge design.
- Excellent holding power and concentricity keeping are available by shrink fitting holder.



R0.3 ~ 1

508P

D Size	D Tolerance
Ø 10 ~ 12	+0 ~ -0.02mm
Ø 13 ~ 21	+0 ~ -0.025mm

단위 : mm

Order Number	날경 Diameter D × R	날장 Length of cut L1	유효장 Effective Length L2	전장 Overall Length L	샙크 Shank Dia d	Order Number	날경 Diameter D × R	날장 Length of cut L1	유효장 Effective Length L2	전장 Overall Length L	샙크 Shank Dia d
4SFDC 100 003 085	10 X R0.3	8.5	12	37	6	4SFDC 130 010 090	13 X R1	9	13	38	6
4SFDC 100 005 085	10 X R0.5	8.5	12	37	6	4SFDC 160 005 120	16 X R0.5	12	17	48	10
4SFDC 100 010 085	10 X R1	8.5	12	37	6	4SFDC 160 010 120	16 X R1	12	17	48	10
4SFDC 110 003 085	11 X R0.3	8.5	12	37	6	4SFDC 170 005 120	17 X R0.5	12	17	48	10
4SFDC 110 005 085	11 X R0.5	8.5	12	37	6	4SFDC 170 010 120	17 X R1	12	17	48	10
4SFDC 110 010 085	11 X R1	8.5	12	37	6	4SFDC 200 005 150	20 X R0.5	15	21	54	12
4SFDC 120 003 090	12 X R0.3	9	13	38	6	4SFDC 200 010 150	20 X R1	15	21	54	12
4SFDC 120 005 090	12 X R0.5	9	13	38	6	4SFDC 210 005 150	21 X R0.5	15	21	54	12
4SFDC 120 010 090	12 X R1	9	13	38	6	4SFDC 210 010 150	21 X R1	15	21	54	12
4SFDC 130 003 090	13 X R0.3	9	13	38	6						
4SFDC 130 005 090	13 X R0.5	9	13	38	6						

# 6~12SFDC

6~12Flutes Diamond Coated Helix Ball Shrink-fit Inserts for Graphite

## 초경 6~12날 열박음 흑연가공용 다이아몬드 코팅 코너 R 인서트

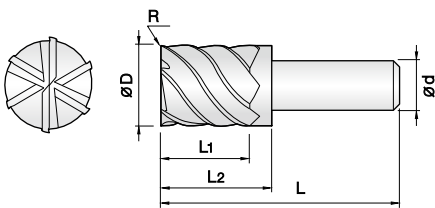

- **그래파이트(흑연) 가공 전용 인서트**
- CVD 순수 다이아몬드 코팅을 적용하여 내마모성이 우수합니다.
- 6~12날까지 적용하여, 고속 가공을 실현하였습니다.
- 열박음 홀더 체결시 높은 파지력과 뛰어난 동심도 유지가 가능합니다.

- **Inserts for graphite milling**
- Excellent wear resistance by applying qualified CVD diamond coating.
- High speed milling process is available with multiple 6-12 flutes.
- Excellent holding power and concentricity keeping are available by shrink fitting holder.



R0.3 ~ 1

508P

D Size	D Tolerance
Ø 10 ~ 12	+0 ~ -0.02mm
Ø 13 ~ 21	+0 ~ -0.025mm

단위 : mm

Order Number	날경 Diameter D × R	날장 Length of cut L1	유효장 Effective Length L2	전장 Overall Length L	샙크 Shank Dia d	Order Number	날경 Diameter D × R	날장 Length of cut L1	유효장 Effective Length L2	전장 Overall Length L	샙크 Shank Dia d
6SFDC 100 003 085	10 X R0.3	8.5	12	37	6	8SFDC 130 010 090	13 X R1	9	13	38	6
6SFDC 100 005 085	10 X R0.5	8.5	12	37	6	10SFDC 160 005 120	16 X R0.5	12	17	48	10
6SFDC 100 010 085	10 X R1	8.5	12	37	6	10SFDC 160 010 120	16 X R1	12	17	48	10
6SFDC 110 003 085	11 X R0.3	8.5	12	37	6	10SFDC 170 005 120	17 X R0.5	12	17	48	10
6SFDC 110 005 085	11 X R0.5	8.5	12	37	6	10SFDC 170 010 120	17 X R1	12	17	48	10
6SFDC 110 010 085	11 X R1	8.5	12	37	6	12SFDC 200 005 150	20 X R0.5	15	21	54	12
8SFDC 120 003 090	12 X R0.3	9	13	38	6	12SFDC 200 010 150	20 X R1	15	21	54	12
8SFDC 120 005 090	12 X R0.5	9	13	38	6	12SFDC 210 005 150	21 X R0.5	15	21	54	12
8SFDC 120 010 090	12 X R1	9	13	38	6	12SFDC 210 010 150	21 X R1	15	21	54	12
8SFDC 130 003 090	13 X R0.3	9	13	38	6						
8SFDC 130 005 090	13 X R0.5	9	13	38	6						

# MHE Modular Head 모듈러 헤드

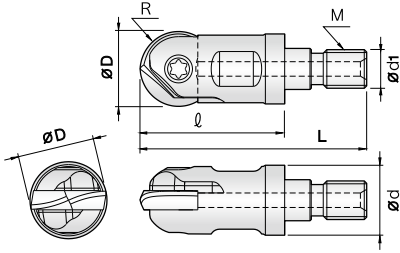

- 볼 인서트 또는 레디우스 인서트 모두 사용 가능합니다.
- 하나의 모듈러 아답터에 다양한 형상의 헤드가 교환 가능하며, 공구비용을 절감할 수 있습니다.
- 아답터가 장비에 장착된 상태에서 헤드만 교환 가능하여, 편의성 및 공구 교체시간이 절감됩니다.

- Can be used for both of ball and corner radius inserts.
- Possible to exchange variety heads for one modular adopter and helps save your purchasing cost.
- Installed modular adopter can change only head without uninstillation, it gives more convenience and it helps save your time.

Order Number	규격 Dimensions (mm)						호환인서트 Insert	부속품 Parts	
	M	D	L	ℓ	d	l		Screw	Wrench
MHE 100 250 M06	M06	10	40	25	9.5	6.5	2JJIN □ 100 / 2JJIN □ 110	SC 100 581142	T10
MHE 120 250 M06	M06	12	40	25	11	6.5	2JJIN □ 120 / 2JJIN □ 130	SC 120 581143	T20
MHE 160 290 M08	M08	16	45	29	14.5	8.5	2JJIN □ 160 / 2JJIN □ 170	SC 160 581144	T20
MHE 200 330 M10	M10	20	55	33	18	10.5	2JJIN □ 200 / 2JJIN □ 210	SC 200 581145	T25
MHE 250 390 M12	M12	25	60	39	22.5	12.5	2JJIN □ 250 / 2JJIN □ 260	SC 250 581146	T30
MHE 300 430 M16	M16	30	70	43	28	17	2JJIN □ 300	SC 300 581147	T30



Bolt Order Number	Screw	Bolt Order Number	Screw
SC 100 581142	T10	SC 250 581146	T30
SC 120 581143	T20	SC 300 581147	T30
SC 160 581144	T20		
SC 200 581145	T25		

# GMA Carbide Modular Adaptor 초경 모듈러 아답터

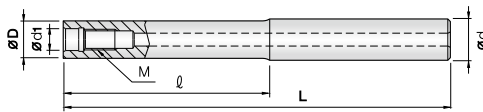

- 나사 모듈러 헤드 전용 아답터(MHE 호환)
- 다양한 유효장으로 깊은 형상의 피삭재 가공이 가능합니다.
- 나사 모듈러 헤드 장착시 체결이 편리합니다.

- Adapter for the spiral modular head (Compatible with MHE)
- Deep cavity milling is available with a variety of effective lengths.
- Convenient clamping with the modular head (MHE).

Order Number	규격 Dimensions (mm)					
	M	D	d	d1	ℓ	L
CMA100 240 114	M06	9.7	10	6.5	24	114
CMA120 240 129	M06	11	12	6.5	24	129
CMA160 300 130	M08	14.5	16	8.5	30	130
CMA160 300 160	M08	14.5	16	8.5	30	160
CMA160 300 200	M08	14.5	16	8.5	30	200
CMA160 300 250	M08	14.5	16	8.5	30	250
CMA200 500 170	M10	18.5	20	10.5	50	170
CMA200 500 220	M10	18.5	20	10.5	50	220
CMA200 500 270	M10	18.5	20	10.5	50	270
CMA250 650 265	M12	23	25	12.5	65	265
CMA250 650 315	M12	23	25	12.5	65	315
CMA300 800 260	M16	28	32	17	80	260
CMA300 800 360	M16	28	32	17	80	360

INSERT

## 초경 열박음 아답터 - 정삭 · 중삭 전용

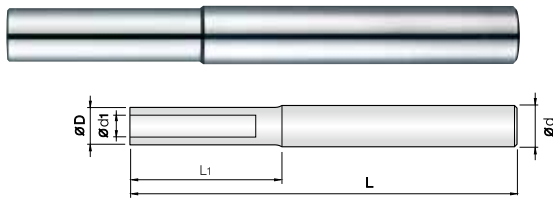

- 일반강, 아크릴, ABS, 목업, 알루미늄 등 비철, 비금속 피삭재 가공
- 다양한 유효장으로 깊은 형상의 피삭재 가공이 가능합니다.
- 열박음 홀더 체결시 높은 파지력과 뛰어난 동심도 유지가 가능합니다.
- 정삭 · 중삭 전용입니다. ※황삭시 파손에 주의하십시오
- 가열된 아답터에 재 히팅 시 수명을 저하시킬수 있으니 완전히 아답터를 냉각후 사용하시길 바랍니다.
- Adapter for the spiral modular head (MHE)
- Deep cavity milling is available with a variety of effective lengths.
- Excellent holding power and concentricity keeping are available by shrink fitting holder. ※Be careful of breakage when roughing.
- Reheating the adapter may decrease its lifespan, so please use it after allowing the adapter to cool completely.

Order Number	규격 Dimensions (mm)					호환인서트 Insert
	D	d1	L1	L	d	
SFMA 100 028 108	9.8	6	28	108	10	□SF□□ 100 / □SF□□ 110
SFMA 100 028 148	9.8	6	28	148	10	□SF□□ 100 / □SF□□ 110
SFMA 100 048 188	9.8	6	48	188	10	□SF□□ 100 / □SF□□ 110
SFMA 120 027 117	11.8	6	27	117	12	□SF□□ 120 / □SF□□ 130
SFMA 120 027 147	11.8	6	27	147	12	□SF□□ 120 / □SF□□ 130
SFMA 120 047 187	11.8	6	47	187	12	□SF□□ 120 / □SF□□ 130
SFMA 160 033 143	15.8	10	33	143	16	□SF□□ 160 / □SF□□ 170
SFMA 160 053 183	15.8	10	53	183	16	□SF□□ 160 / □SF□□ 170
SFMA 200 039 139	19.8	12	39	139	20	□SF□□ 200 / □SF□□ 210
SFMA 200 059 179	19.8	12	59	179	20	□SF□□ 200 / □SF□□ 210
SFMA 200 079 229	19.8	12	79	229	20	□SF□□ 200 / □SF□□ 210

## 초경 인덱서블 커터

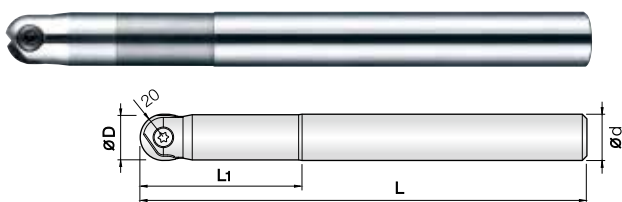

- 볼 인서트 또는 레디우스 인서트 모두 사용 가능합니다.
- Solid 엔드밀과 동일한 강도를 가져 고속, 고정밀 가공에 적합합니다.
- 홀더 파손시 재생이 가능합니다.
- 스틸 홀더와 비교하여 떨림이 최소화되어 안정적인 가공이 가능합니다.

- Can be used for both of ball and corner radius inserts.
- Suitable for high speed cutting and high precise cutting due to same toughness as solid tools.
- Availabe repairing tool holders at JJ TOOLS co., ltd when broken problem.
- Availabe stable machining due to minimized vibration on carbide holders.

Order Number	규격 Dimensions (mm)				호환인서트 Insert	부속품 Parts	
	D	L1	L	d		ScrewWrench	
CICF100 350 150	10	35	150	10	2JJIN □ 100 / 2JJIN □ 110	SC 100 581142	T10
CICF120 450 160	12	45	160	12	2JJIN □ 120 / 2JJIN □ 130	SC 120 581143	T20
CICF160 600 200	16	60	200	16	2JJIN □ 160 / 2JJIN □ 170	SC 160 581144	T20
CICF160 600 230	16	60	230	16	2JJIN □ 160 / 2JJIN □ 170	SC 160 581144	T20
CICF200 700 220	20	70	220	20	2JJIN □ 200 / 2JJIN □ 210	SC 200 581145	T25
CICF250 800 250	25	80	250	25	2JJIN □ 250 / 2JJIN □ 260	SC 250 581146	T30
CICF250 800 300	25	80	300	25	2JJIN □ 250 / 2JJIN □ 260	SC 250 581146	T30
CICF300 1000 300	30	100	300	30	2JJIN □ 300	SC 300 581147	T30

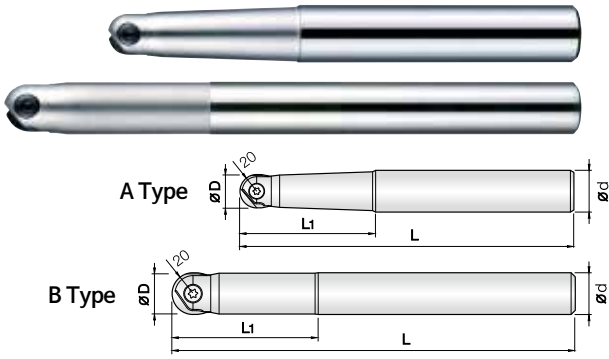

- 볼 인서트 또는 레디우스 인서트 모두 사용 가능합니다.
- 유효장을 테이퍼 형상으로 설계하여 떨림을 최소화 하였습니다(A-Type).
- 다양한 전장 규격을 적용하여, 공구 선택의 폭이 넓습니다.
- Can be used for both of ball and corner radius inserts.
- Effective length design by taper type to minimize vibration (A-Type).
- Wide tool range option is available with a variety of overall lengths.

Order Number	규격 Dimensions (mm)					호환인서트 Insert	부속품 Parts	
	D	L1	L	d	Type		Screw	Wrench
ICF 100 250 100 S12	10	25	100	12	A	2JJIN □ 100 / 2JJIN □ 110	SC 100 581142	T10
ICF 100 500 150 S16	10	50	150	16	A	2JJIN □ 100 / 2JJIN □ 110	SC 100 581142	T10
ICF 120 300 110 S12	12	30	110	12	B	2JJIN □ 120 / 2JJIN □ 130	SC 120 581143	T20
ICF 120 600 160 S16	12	60	160	16	A	2JJIN □ 120 / 2JJIN □ 130	SC 120 581143	T20
ICF 160 500 130 S20	16	50	130	20	A	2JJIN □ 160 / 2JJIN □ 170	SC 160 581144	T20
ICF 160 600 220 S16	16	60	220	16	B	2JJIN □ 160 / 2JJIN □ 170	SC 160 581144	T20
ICF 160 650 160 S20	16	65	160	20	A	2JJIN □ 160 / 2JJIN □ 170	SC 160 581144	T20
ICF 200 700 220 S20	20	70	220	20	B	2JJIN □ 200 / 2JJIN □ 210	SC 200 581145	T25
ICF 200 700 250 S20	20	70	250	20	B	2JJIN □ 200 / 2JJIN □ 210	SC 200 581145	T25
ICF 200 800 180 S25	20	80	180	25	A	2JJIN □ 200 / 2JJIN □ 210	SC 200 581145	T25
ICF 250 700 220 S25	25	70	220	25	B	2JJIN □ 250 / 2JJIN □ 260	SC 250 581146	T30
ICF 250 800 250 S25	25	80	250	25	B	2JJIN □ 250 / 2JJIN □ 260	SC 250 581146	T30
ICF 250 800 300 S25	25	80	300	25	B	2JJIN □ 250 / 2JJIN □ 260	SC 250 581146	T30
ICF 300 1000 250 S32	30	100	250	32	A	2JJIN □ 300	SC 300 581147	T30
ICF 300 1000 300 S32	30	100	300	32	A	2JJIN □ 300	SC 300 581147	T30
ICF 300 1000 350 S32	30	100	350	32	A	2JJIN □ 300	SC 300 581147	T30



그림1 Figure1



그림2 Figure2

### 인서트 재연마 시 유의 사항 Note for regrinding insert

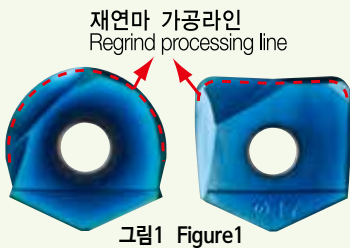
- 인서트가 [그림1]의 재연마 라인보다 깊게 손상된 경우에는 재연마 작업이 불가합니다.
- 재연마시 인서트의 높이(H)가 0.3~0.5 정도 짧아져 [그림2]의 홀더 끝 부분과 피삭재 사이에 간섭이 일어날수 있습니다. 작업에 유의해 주시기 바랍니다.
- If the insert is damaged deeper than the regrind processing line, regrinding is not available.
- When the regrinding process, the height of the insert (H) will be shortened by 0.3mm to 0.5mm, so insert holder (figure 2) may cause interference your machining process. Please note for your work.
- 흑연 가공용 DIA 코팅 인서트는 재연마가 불가 합니다.
- Regrinding DIA coated insert for graphite material is not available.

### 열박음 인서트 재연마 Regrinding shrink-fit insert

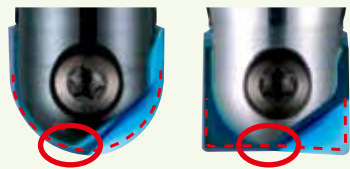
- 2~3회 재연마가 가능하며, 경제적입니다.
- 재연마 시 신제품과 동등한 수준의 성능을 발휘합니다.
- 2 to 3 times regrinding is available, so it is economical.
- Regrinding performs the same as new product quality.
- 흑연 가공용 DIA 코팅 인서트는 재연마가 불가 합니다.
- Regrinding DIA coated insert for graphite material is not available.

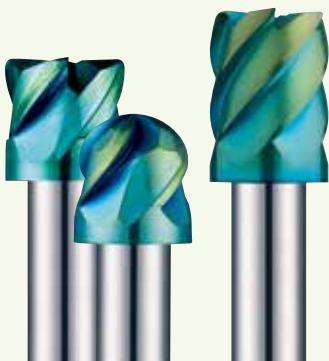

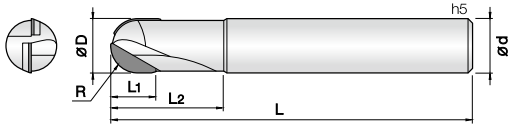

- 알루미늄 합금 및 비철 금속전용 PCD 엔드밀
- LASER 가공으로 날부 인선을 5µm 이하로 구현하여 탁월한 절삭성과 피삭재의 표면 조도가 뛰어납니다.
- 뛰어난 동심도로 제작되어 정밀가공이 가능합니다.
- 인선부를 폴리싱 처리하여 절삭 칩의 배출이 원활합니다.

#### PCD Endmills for aluminum alloys and non-ferrous metals

- Laser processing enables the blade to be less than 5µm, providing excellent cutting performance and surface finish of the workpiece.
- Designed with excellent concentricity for precision machining.
- An additional polishing process on the edge of flutes to facilitates the cutting chip emission.

1

2

WC  
미립자

PCD

R  
± 0.005

0°  
Helix Angle

CUTTING  
DATA

1.5 ~ 8R

509P

D Size	D Tolerance
ø 3 ~ 6	+0 ~ -0.012mm
ø 8 ~ 12	+0 ~ -0.015mm
ø 12	+0 ~ -0.018mm
ø 16	+0 ~ -0.022mm

단위 : mm

Order Number	날경 Diameter R × D	날장 Length of cut L1	유효장 Effective Length L2	전장 Overall Length L	생크 Shank Dia d	비고	Order Number	날경 Diameter R × D	날장 Length of cut L1	유효장 Effective Length L2	전장 Overall Length L	생크 Shank Dia d	비고
1BPCD 030 080 S06	1.5R X 3	2.3	8	50	6								
1BPCD 030 120 S06	1.5R X 3	2.3	12	50	6								
1BPCD 030 180 S06	1.5R X 3	2.3	18	60	6								
1BPCD 040 100 S06	2R X 4	3.3	10	50	6								
1BPCD 040 120 S06	2R X 4	3.3	12	50	6								
1BPCD 040 180 S06	2R X 4	3.3	18	60	6								
2BPCD 060 120 S06	3R X 6	5.1	12	60	6								
2BPCD 060 150 S06	3R X 6	5.1	15	65	6								
2BPCD 060 200 S06	3R X 6	5.1	20	70	6								
2BPCD 060 250 100	3R X 6	5.1	25	100	6								
2BPCD 080 150 S08	4R X 8	7	15	60	8								
2BPCD 080 300 110	4R X 8	7	30	110	8								
2BPCD 100 200 S10	5R X 10	8	20	70	10								
2BPCD 100 300 110	5R X 10	8	30	110	10								
2BPCD 100 350 150	5R X 10	8	35	150	10								
2BPCD 120 250 S12	6R X 12	9	25	80	12								
2BPCD 120 350 110	6R X 12	9	35	110	12								
2BPCD 120 400 150	6R X 12	9	40	150	12								
2BPCD 160 350 S16	8R X 16	12	35	90	16								
2BPCD 160 450 110	8R X 16	12	45	110	16								
2BPCD 160 500 150	8R X 16	12	50	150	16								



# 1~4PCD 1~4 Flutes PCD Endmills by Laser Processing

## 1~4날 레이저 가공 PCD 엔드밀

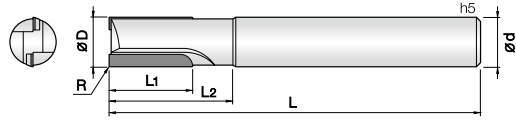

- 알루미늄 합금 및 비철 금속전용 PCD 엔드밀
- LASER 가공으로 날부 인선을 5 $\mu$ m이하로 구현하여 탁월한 절삭성과 피삭재의 표면 조도가 뛰어납니다.
- 뛰어난 동심도로 제작되어 정밀가공이 가능합니다.
- 인선부를 폴리싱 처리하여 절삭 칩의 배출이 원활합니다.

### PCD Endmills for aluminum alloys and non-ferrous metals

- Laser processing enables the blade to be less than 5 $\mu$ m, providing excellent cutting performance and surface finish of the workpiece.
- Designed with excellent concentricity for precision machining.
- An additional polishing process on the edge of flutes to facilitates the cutting chip emission.

1 2 3 4 **WC** 미립자 **PCD** **RJ**  $\pm 0.005$  **0°** Helix Angle **CUTTING DATA** 509P

D Size	D Tolerance
$\varnothing 3 \sim 6$	+0 ~ -0.012mm
$\varnothing 8 \sim 10$	+0 ~ -0.015mm
$\varnothing 12$	+0 ~ -0.018mm
$\varnothing 16 \sim 20$	+0 ~ -0.022mm

Order Number	날경 Diameter D × R	날장 Length of cut L1	유효장 Effective Length L2	전장 Overall Length L	생크 Shank Dia d	비고	Order Number	날경 Diameter D × R	날장 Length of cut L1	유효장 Effective Length L2	전장 Overall Length L	생크 Shank Dia d	비고
1PCD 030 080 S04	3 X R0.1	4	8	50	4		3PCD 120 300 090	12 X R0.1	20	30	90	12	
1PCD 040 100 S06	4 X R0.1	5	10	50	6		3PCD 160 250 S16	16 X R0.1	15	25	90	16	
2PCD 060 200 S06	6 X R0.1	10	20	60	6		3PCD 160 350 S16	16 X R0.1	20	35	130	16	
2PCD 060 250 S06	6 X R0.1	15	25	60	6		3PCD 160 400 S16	16 X R0.1	25	40	160	16	
2PCD 060 250 080	6 X R0.1	15	25	80	6		3PCD 200 250 S20	20 X R0.1	15	25	90	20	
2PCD 080 200 S08	8 X R0.1	10	20	60	8		3PCD 200 350 S20	20 X R0.1	20	35	130	20	
2PCD 080 250 S08	8 X R0.1	15	25	60	8		3PCD 200 400 S20	20 X R0.1	25	40	160	20	
2PCD 080 300 S08	8 X R0.1	20	30	70	8		4PCD 160 250 S16	16 X R0.1	15	25	90	16	
2PCD 080 300 100	8 X R0.1	20	30	100	8		4PCD 160 350 S16	16 X R0.1	20	35	130	16	
2PCD 100 250 S10	10 X R0.1	10	25	70	10		4PCD 160 400 S16	16 X R0.1	25	40	160	16	
2PCD 100 300 S10	10 X R0.1	15	30	70	10		4PCD 200 250 S20	20 X R0.1	15	25	90	20	
2PCD 100 300 080	10 X R0.1	20	30	80	10		4PCD 200 350 S20	20 X R0.1	20	35	130	20	
2PCD 100 300 110	10 X R0.1	20	30	110	10		4PCD 200 400 S20	20 X R0.1	25	40	160	20	
2PCD 120 250 S12	12 X R0.1	10	25	80	12								
2PCD 120 300 S12	12 X R0.1	15	30	80	12								
2PCD 120 300 090	12 X R0.1	20	30	90	12								
2PCD 120 300 130	12 X R0.1	20	30	130	12								
2PCD 160 250 S16	16 X R0.1	10	25	90	16								
2PCD 160 300 S16	16 X R0.1	15	30	90	16								
2PCD 160 350 S16	16 X R0.1	20	35	100	16								
2PCD 200 250 S20	20 X R0.1	10	25	90	20								
2PCD 200 300 S20	20 X R0.1	15	30	90	20								
2PCD 200 300 100	20 X R0.1	20	30	100	20								

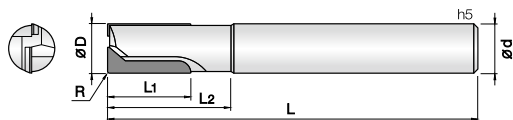

- 알루미늄 합금 및 비철 금속전용 PCD 엔드밀
  - LASER 가공으로 날부 인선을 5 $\mu$ m이하로 구현하여 탁월한 절삭성과 피삭재의 표면 조도가 뛰어납니다.
  - 뛰어난 동심도로 제작되어 정밀가공이 가능합니다.
  - 인선부를 폴리싱 처리하여 절삭 칩의 배출이 원활합니다.
- PCD Endmills for aluminum alloys and non-ferrous metals
  - Laser processing enables the blade to be less than 5 $\mu$ m, providing excellent cutting performance and surface finish of the workpiece.
  - Designed with excellent concentricity for precision machining.
  - An additional polishing process on the edge of flutes to facilitates the cutting chip emission.



D Size	D Tolerance
Ø 6	+0 ~ -0.012mm
Ø 8 ~ 10	+0 ~ -0.015mm
Ø 12	+0 ~ -0.018mm
Ø 16 ~ 20	+0 ~ -0.022mm

Order Number	날경 Diameter D × R	날장 Length of cut L1	유효장 Effective Length L2	전장 Overall Length L	샙크 Shank Dia d	비고
2CPCD 060 200 S06	6 X R0.1	10	20	60	6	
2CPCD 060 250 S06	6 X R0.1	15	25	60	6	
2CPCD 080 200 S08	8 X R0.1	10	20	60	8	
2CPCD 080 250 S08	8 X R0.1	15	25	60	8	
2CPCD 080 250 070	8 X R0.1	20	25	70	8	
2CPCD 100 250 S10	10 X R0.1	10	25	70	10	
2CPCD 100 300 S10	10 X R0.1	15	30	70	10	
2CPCD 100 300 080	10 X R0.1	20	30	80	10	
2CPCD 120 250 S12	12 X R0.1	10	25	80	12	
2CPCD 120 300 S12	12 X R0.1	15	30	80	12	
2CPCD 120 300 090	12 X R0.1	20	30	90	12	
2CPCD 160 250 S16	16 X R0.1	10	25	90	16	
2CPCD 160 300 S16	16 X R0.1	15	30	90	16	
2CPCD 160 300 100	16 X R0.1	20	30	100	16	
2CPCD 200 250 S20	20 X R0.1	10	25	90	20	
2CPCD 200 300 S20	20 X R0.1	15	30	90	20	
2CPCD 200 300 100	20 X R0.1	20	30	100	20	

단위 : mm

Order Number	날경 Diameter D × R	날장 Length of cut L1	유효장 Effective Length L2	전장 Overall Length L	샙크 Shank Dia d	비고
3CPCD 160 250 S16	16 X R0.1	15	25	90	16	
3CPCD 160 300 S16	16 X R0.1	20	30	100	16	
4CPCD 200 300 S20	20 X R0.1	15	30	90	20	
4CPCD 200 350 S20	20 X R0.1	20	35	100	20	

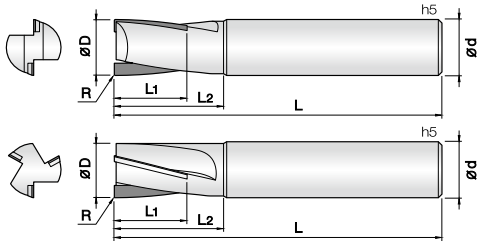

- 알루미늄 합금 및 비철 금속전용 PCD 엔드밀
- LASER 가공으로 날부 인선을 5µm이하로 구현하여 탁월한 절삭성능과 피삭재의 표면 조도가 뛰어납니다.
- 뛰어난 동심도로 제작되어 정밀가공이 가능합니다.
- 옆날 인선부의 헬릭스 설계로 절삭저항이 적으며, 내마모 성능을 향상 시켰습니다.
- 인선부를 폴리싱 처리하여 절삭 칩의 배출이 원활합니다.

#### PCD Endmills for aluminum alloys and non-ferrous metals

- Laser processing enables the blade to be less than 5µm, providing excellent cutting performance and surface finish of the workpiece.
- Designed with excellent concentricity for precision machining.
- Helix design on the side of the edge reduces cutting resistance and improves wear resistance.
- An additional polishing process on the edge of flutes to facilitates the cutting chip emission.



D Size	D Tolerance
Ø 4 ~ 6	+0 ~ -0.012mm
Ø 8 ~ 10	+0 ~ -0.015mm
Ø 12	+0 ~ -0.018mm
Ø 16 ~ 20	+0 ~ -0.022mm

Order Number	날경 Diameter D × R	날장 Length of cut L1	유효장 Effective Length L2	타입 Type	전장 Overall Length L	샙크 Shank Dia d	Order Number	날경 Diameter D × R	날장 Length of cut L1	유효장 Effective Length L2	타입 Type	전장 Overall Length L	샙크 Shank Dia d
1HPCD 040 180 S06	4 X R0.1	10	18	A	60	6	3HPCD 120 250 S12	12 X R0.1	15	25	A	80	12
2HPCD 060 180 S06	6 X R0.1	10	18	A	60	6	3HPCD 120 450 S12	12 X R0.1	30	45	B	100	12
2HPCD 060 250 S06	6 X R0.1	15	25	B	80	6	3HPCD 160 300 S16	16 X R0.1	20	30	A	90	16
2HPCD 080 200 S08	8 X R0.1	10	20	A	70	8	3HPCD 160 450 S16	16 X R0.1	30	45	B	110	16
2HPCD 080 250 S08	8 X R0.1	20	25	B	90	8	3HPCD 200 400 S20	20 X R0.1	25	40	A	100	20
2HPCD 100 220 S10	10 X R0.1	12	22	A	70	10	3HPCD 200 550 S20	20 X R0.1	40	55	B	110	20
2HPCD 100 400 S10	10 X R0.1	25	40	B	100	10							
2HPCD 120 250 S12	12 X R0.1	15	25	A	80	12							
2HPCD 120 450 S12	12 X R0.1	30	45	B	100	12							
2HPCD 160 300 S16	16 X R0.1	20	30	A	90	16							
2HPCD 160 450 S16	16 X R0.1	30	45	B	110	16							
2HPCD 200 400 S20	20 X R0.1	25	40	A	100	20							
2HPCD 200 550 S20	20 X R0.1	40	55	B	110	20							

## 2&3날 레이저 가공 PCD 라핑 엔드밀

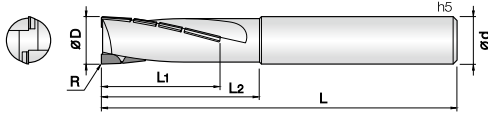

- 알루미늄 합금 및 비철 금속전용 PCD 엔드밀
- LASER 가공으로 날부 인선을 5 $\mu$ m이하로 구현하여 탁월한 절삭성능과 피삭재의 표면 조도가 뛰어납니다.
- 뛰어난 동심도로 제작되어 정밀가공이 가능합니다.
- 옆날 인선부의 헬릭스 설계로 절삭저항이 적으며, 내마모 성능을 향상 시켰습니다.
- 인선부를 폴리싱 처리하여 절삭 칩의 배출이 원활합니다.
- PCD Endmills for aluminum alloys and non-ferrous metals
- Laser processing enables the blade to be less than 5 $\mu$ m, providing excellent cutting performance and surface finish of the workpiece.
- Designed with excellent concentricity for precision machining.
- Helix design on the side of the edge reduces cutting resistance and improves wear resistance.
- An additional polishing process on the edge of flutes to facilitates the cutting chip emission.



509P

D Size	D Tolerance
ø 10	+0 ~ -0.015mm
ø 12	+0 ~ -0.018mm
ø 16 ~ 20	+0 ~ -0.022mm

단위 : mm

Order Number	날경 Diameter D × R	날장 Length of cut L1	유효장 Effective Length L2	전장 Overall Length L	샙크 Shank Dia d	Order Number	날경 Diameter D × R	날장 Length of cut L1	유효장 Effective Length L2	전장 Overall Length L	샙크 Shank Dia d
2RPCD 100 300 S10	10 X R0.1	20	30	80	10	3RPCD 100 300 S10	10 X R0.1	20	30	80	10
2RPCD 100 400 S10	10 X R0.1	30	40	90	10	3RPCD 100 400 S10	10 X R0.1	30	40	90	10
2RPCD 120 300 S12	12 X R0.1	20	30	80	12	3RPCD 120 300 S12	12 X R0.1	20	30	80	12
2RPCD 120 400 S12	12 X R0.1	30	40	90	12	3RPCD 120 400 S12	12 X R0.1	30	40	90	12
2RPCD 160 400 S16	16 X R0.1	30	40	100	16	3RPCD 160 400 S16	16 X R0.1	30	40	100	16
2RPCD 160 650 S16	16 X R0.1	50	65	130	16	3RPCD 160 650 S16	16 X R0.1	50	65	130	16
2RPCD 200 400 S20	20 X R0.1	30	40	100	20	3RPCD 200 400 S20	20 X R0.1	30	40	100	20
2RPCD 200 650 S20	20 X R0.1	50	65	130	20	3RPCD 200 650 S20	20 X R0.1	50	65	130	20

# 1&2PCDC 1 & 2 Flutes PCD Corner Radius Endmills by Laser Processing

## 1&2날 레이저 가공 PCD 코너 레디우스 엔드밀

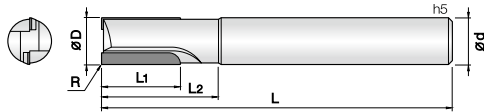

- 알루미늄 합금 및 비철 금속 전용 PCD 엔드밀
- LASER 가공으로 날부 인선을 5 $\mu$ m 이하로 구현하여 탁월한 절삭성과 피삭재의 표면 조도가 뛰어납니다.
- 뛰어난 동심도로 제작되어 정밀가공이 가능합니다.
- 인선부를 폴리싱 처리하여 절삭 칩의 배출이 원활합니다.

### • PCD Endmills for aluminum alloys and non-ferrous metals

- Laser processing enables the blade to be less than 5 $\mu$ m, providing excellent cutting performance and surface finish of the workpiece.
- Designed with excellent concentricity for precision machining.
- An additional polishing process on the edge of flutes to facilitates the cutting chip emission.

**1**

**2**

WC  
미립자

PCD

R  
± 0.005

0°  
Helix Angle

CUTTING  
DATA

R0.2 ~ 1     509P

D Size	D Tolerance
∅ 4 ~ 6	+0 ~ -0.012mm
∅ 8 ~ 10	+0 ~ -0.015mm
∅ 12	+0 ~ -0.018mm

단위 : mm

Order Number	날경 Diameter D × R	날장 Length of cut L1	유효장 Effective Length L2	전장 Overall Length L	샙크 Shank Dia d	비고	Order Number	날경 Diameter D × R	날장 Length of cut L1	유효장 Effective Length L2	전장 Overall Length L	샙크 Shank Dia d	비고
1PCDC 040 002 100	4 X R0.2	5	10	50	6								
1PCDC 040 003 100	4 X R0.3	5	10	50	6								
2PCDC 060 003 200	6 X R0.3	6	20	60	6								
2PCDC 060 003 250	6 X R0.3	15	25	60	6								
2PCDC 060 005 200	6 X R0.5	6	20	60	6								
2PCDC 060 005 250	6 X R0.5	15	25	60	6								
2PCDC 060 010 200	6 X R1	6	20	60	6								
2PCDC 060 010 250	6 X R1	15	25	60	6								
2PCDC 080 003 200	8 X R0.3	8	20	60	8								
2PCDC 080 003 250	8 X R0.3	15	25	60	8								
2PCDC 080 005 200	8 X R0.5	8	20	60	8								
2PCDC 080 005 250	8 X R0.5	15	25	60	8								
2PCDC 080 010 200	8 X R1	8	20	60	8								
2PCDC 080 010 250	8 X R1	15	25	60	8								
2PCDC 100 005 250	10 X R0.5	10	25	70	10								
2PCDC 100 005 300	10 X R0.5	15	30	70	10								
2PCDC 100 010 250	10 X R1	10	25	70	10								
2PCDC 100 010 300	10 X R1	15	30	70	10								
2PCDC 120 005 250	12 X R0.5	10	25	80	12								
2PCDC 120 005 300	12 X R0.5	15	30	80	12								
2PCDC 120 010 250	12 X R1	10	25	80	12								
2PCDC 120 010 300	12 X R1	15	30	80	12								

PCD series

# 1&2BPCDW

## 1 & 2 Flutes PCD Ball Endmills by Wire Processing

### 1&2날 와이어 가공 PCD 볼 엔드밀

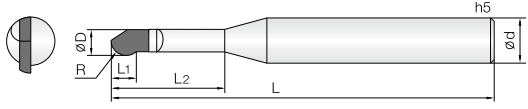

- 그래파이트(흑연), 알루미늄 합금 및 비철 금속 전용
- PCD 날부 인선을 구현하여 그래파이트 가공시 피삭재의 표면 조도가 뛰어나며 내마모성이 탁월합니다.
- 인선부를 폴리싱 처리하여 절삭 칩의 배출이 원활합니다.

#### PCD Endmills for graphite, aluminum alloys and non-ferrous metals

- The edge of the PCD flute enables excellent surface finish and wear resistance during graphite machining.
- An additional polishing process on the edge of flutes to facilitates the cutting chip emission.



D Size	D Tolerance
Ø 3 ~ 6	+0 ~ -0.012mm
Ø 8 ~ 10	+0 ~ -0.015mm
Ø 12	+0 ~ -0.018mm

단위 : mm

Order Number	날경 Diameter R × D	날장 Length of cut L1	유효장 Effective Length L2	전장 Overall Length L	생크 Shank Dia d	비고
1BPCDW 030 060 S04	1.5R X 3	2.3	6	60	4	
1BPCDW 030 100 S04	1.5R X 3	2.3	10	80	4	
1BPCDW 030 200 S04	1.5R X 3	2.3	20	80	4	
1BPCDW 030 300 S04	1.5R X 3	2.3	30	80	4	
1BPCDW 040 060 S06	2R X 4	3.3	6	60	6	
1BPCDW 040 100 S06	2R X 4	3.3	10	80	6	
1BPCDW 040 200 S06	2R X 4	3.3	20	80	6	
1BPCDW 040 300 S06	2R X 4	3.3	30	80	6	
2BPCDW 060 051 S06	3R X 6	5.1	-	60	6	
2BPCDW 060 200 S06	3R X 6	5.1	20	90	6	
2BPCDW 060 300 S06	3R X 6	5.1	30	90	6	
2BPCDW 060 400 S06	3R X 6	5.1	40	100	6	
2BPCDW 080 300 S08	4R X 8	7	30	80	8	
2BPCDW 080 500 S08	4R X 8	7	50	150	8	
2BPCDW 100 300 S10	5R X 10	8	30	80	10	
2BPCDW 100 500 S10	5R X 10	8	50	150	10	
2BPCDW 120 300 S12	6R X 12	9	30	80	12	
2BPCDW 120 500 S12	6R X 12	9	50	150	12	

Order Number	날경 Diameter R × D	날장 Length of cut L1	유효장 Effective Length L2	전장 Overall Length L	생크 Shank Dia d	비고

PCD series

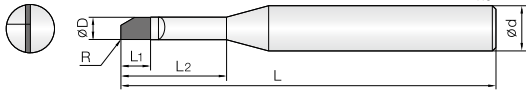

- **그래파이트 (흑연), 알루미늄 합금 및 비철 금속 전용**
  - PCD 날부 인선을 구현하여 그래파이트 가공시 피삭재의 표면 조도가 뛰어나며 내마모성이 탁월합니다.
  - 인선부를 폴리싱 처리하여 절삭 칩의 배출이 원활합니다.
- **PCD Endmills for graphite, aluminum alloys and non-ferrous metals**
  - The edge of the PCD flute enables excellent surface finish and wear resistance during graphite machining.
  - An additional polishing process on the edge of flutes to facilitates the cutting chip emission.

Icons representing: 1 (number of flutes), 2 (number of flutes), WC (material), PCD (type), R (radius tolerance  $\pm 0.005$ ),  $0^\circ$  (Helix Angle), CUTTING DATA (type 509P).

D Size	D Tolerance
Ø 3 ~ 6	+0 ~ -0.012mm
Ø 8 ~ 10	+0 ~ -0.015mm
Ø 12	+0 ~ -0.018mm

Order Number	날경 Diameter D x R	날장 Length of cut L1	유효장 Effective Length L2	전장 Overall Length L	생크 Shank Dia d	비고	Order Number	날경 Diameter D x R	날장 Length of cut L1	유효장 Effective Length L2	전장 Overall Length L	생크 Shank Dia d	비고
1PCDW 030 060 S04	3 X R0.1	4	6	60	4								
1PCDW 030 100 S04	3 X R0.1	4	10	80	4								
1PCDW 030 200 S04	3 X R0.1	4	20	80	4								
1PCDW 030 300 S04	3 X R0.1	4	30	80	4								
1PCDW 040 060 S06	4 X R0.1	5	6	60	6								
1PCDW 040 100 S06	4 X R0.1	5	10	80	6								
1PCDW 040 200 S06	4 X R0.1	5	20	80	6								
1PCDW 040 300 S06	4 X R0.1	5	30	80	6								
2PCDW 060 100 S06	6 X R0.1	10	-	60	6								
2PCDW 060 200 S06	6 X R0.1	10	20	90	6								
2PCDW 060 300 S06	6 X R0.1	10	30	90	6								
2PCDW 060 400 S06	6 X R0.1	10	40	100	6								
2PCDW 080 300 S08	8 X R0.1	10	30	80	8								
2PCDW 080 500 S08	8 X R0.1	10	50	150	8								
2PCDW 100 300 S10	10 X R0.1	12	30	80	10								
2PCDW 100 500 S10	10 X R0.1	12	50	150	10								
2PCDW 120 300 S12	12 X R0.1	12	30	80	12								
2PCDW 120 500 S12	12 X R0.1	12	50	150	12								

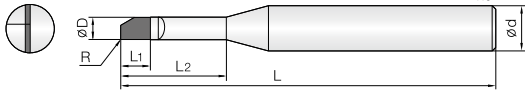

- 그래파이트(흑연), 알루미늄 합금 및 비철 금속 전용
- PCD 날부 인선을 구현하여 그래파이트 가공시 피삭재의 표면 조도가 뛰어나며 내마모성이 탁월합니다.
- 인선부를 폴리싱 처리하여 절삭 칩의 배출이 원활합니다.
- PCD Endmills for graphite, aluminum alloys and non-ferrous metals
- The edge of the PCD flute enables excellent surface finish and wear resistance during graphite machining.
- An additional polishing process on the edge of flutes to facilitates the cutting chip emission.

1 2 WC 미립자 PCD ±0.005 R0.2 ~ 1 0° Helix Angle CUTTING DATA 509P

D Size	D Tolerance
Ø 4 ~ 6	+0 ~ -0.012mm
Ø 8 ~ 10	+0 ~ -0.015mm
Ø 12	+0 ~ -0.018mm

단위: mm

Order Number	날경 Diameter D × R	날장 Length of cut L1	유효장 Effective Length L2	전장 Overall Length L	샹크 Shank Dia d	비고	Order Number	날경 Diameter D × R	날장 Length of cut L1	유효장 Effective Length L2	전장 Overall Length L	샹크 Shank Dia d	비고	
1CPCDW 040 002 100	4 X R0.2	5	10	50	6									
1CPCDW 040 003 100	4 X R0.3	5	10	50	6									
2CPCDW 060 003 200	6 X R0.3	6	20	60	6									
2CPCDW 060 003 250	6 X R0.3	15	25	60	6									
2CPCDW 060 005 200	6 X R0.5	6	20	60	6									
2CPCDW 060 005 250	6 X R0.5	15	25	60	6									
2CPCDW 060 010 200	6 X R1	6	20	60	6									
2CPCDW 060 010 250	6 X R1	15	25	60	6									
2CPCDW 080 003 200	8 X R0.3	8	20	60	8									
2CPCDW 080 003 250	8 X R0.3	15	25	60	8									
2CPCDW 080 005 200	8 X R0.5	8	20	60	8									
2CPCDW 080 005 250	8 X R0.5	15	25	60	8									
2CPCDW 080 010 200	8 X R1	8	20	60	8									
2CPCDW 080 010 250	8 X R1	15	25	60	8									
2CPCDW 100 005 250	10 X R0.5	10	25	70	10									
2CPCDW 100 005 300	10 X R0.5	15	30	70	10									
2CPCDW 100 010 250	10 X R1	10	25	70	10									
2CPCDW 100 010 300	10 X R1	15	30	70	10									
2CPCDW 120 005 250	12 X R0.5	10	25	80	12									
2CPCDW 120 005 300	12 X R0.5	15	30	80	12									
2CPCDW 120 010 250	12 X R1	10	25	80	12									
2CPCDW 120 010 300	12 X R1	15	30	80	12									



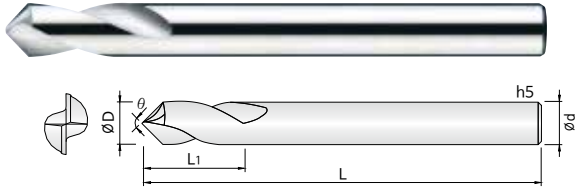

- HRC50이하 고경도강, 프리하든강, 공구강, 주철 등 피삭재 가공
- 실리콘계 코팅 (Si) 처리하여 내마모성이 우수합니다.
- 헬릭스 타입 2날을 적용하여 센터링 작업에 적합합니다.
- 코팅과 비코팅으로 구분하여 수지, 아크릴 등의 가공도 가능합니다.
- 미립자 초경합금을 채택하여 다양한 비철합금 및 목업의 피삭재 영역에 적용 가능합니다.

- Drills for various work materials, hardened steels (~HRC50), pre-hardened steels, tool steels and cast irons
- Good wear resistance by Si-based PVD coating.
- Optimum for centering with helix 2flutes.
- Resin, plastic machining applicable with coated or non coated endmill.
- Applied fine WC grade optimized for various non-ferrous and non-metallic work materials.



509P

D Size	D Tolerance
Ø 0.3 ~ 4	+0 ~ -0.012mm
Ø 6 ~ 12	-0.01 ~ -0.025mm
Ø 16	-0.015 ~ -0.03mm

단위 : mm

Order Number		날경 Diameter D	각도 Angle θ	홈길이 Flute Length L1	전장 Overall Length L	샤프트 Shank Dia d	비고	
비코팅 Un coated	코팅 Coated						비코팅 Un coated	코팅 Coated
2SPO 003 090 040	2SPOC 003 090 040	0.3	90°	0.9	40	3		
2SPO 005 090 040	2SPOC 005 090 040	0.5	90°	1.5	40	3		
2SPO 008 090 040	2SPOC 008 090 040	0.8	90°	2.4	40	3		
2SPO 010 090 050	2SPOC 010 090 050	1	90°	3	50	3		
	2SPOC 010 090 080	1	90°	3	80	3		
2SPO 010 120 050	2SPOC 010 120 050	1	120°	3	50	3		
2SPO 015 090 050	2SPOC 015 090 050	1.5	90°	4.5	50	3		
2SPO 020 090 050	2SPOC 020 090 050	2	90°	6	50	3		
	2SPOC 020 090 080	2	90°	6	80	3		
2SPO 020 120 050	2SPOC 020 120 050	2	120°	6	50	3		
2SPO 030 090 050	2SPOC 030 090 050	3	90°	10	50	3		
2SPO 030 120 050	2SPOC 030 120 050	3	120°	10	50	3		
2SPO 030 090 100	2SPOC 030 090 100	3	90°	10	100	3		
2SPO 030 120 100	2SPOC 030 120 100	3	120°	10	100	3		
2SPO 040 090 050	2SPOC 040 090 050	4	90°	12	50	4		
2SPO 040 120 050	2SPOC 040 120 050	4	120°	12	50	4		
2SPO 040 090 100	2SPOC 040 090 100	4	90°	12	100	4		
2SPO 040 120 100	2SPOC 040 120 100	4	120°	12	100	4		
New 2SPO 050 090 060	2SPOC 050 090 060	5	90	13	60	5		
New 2SPO 050 120 060	2SPOC 050 120 060	5	120	13	60	5		
New 2SPO 050 090 110	2SPOC 050 090 110	5	90	13	110	5		
New 2SPO 050 120 110	2SPOC 050 120 110	5	120	13	110	5		
2SPO 060 090 070	2SPOC 060 090 070	6	90°	15	70	6		
2SPO 060 120 070	2SPOC 060 120 070	6	120°	15	70	6		
2SPO 060 090 110	2SPOC 060 090 110	6	90°	15	110	6		
	2SPOC 060 090 150	6	90°	15	150	6		
2SPO 060 120 110	2SPOC 060 120 110	6	120°	15	110	6		
2SPO 080 090 080	2SPOC 080 090 080	8	90°	25	80	8		
	2SPOC 080 090 150	8	90°	25	150	8		
2SPO 080 120 080	2SPOC 080 120 080	8	120°	25	80	8		
2SPO 100 090 090	2SPOC 100 090 090	10	90°	25	90	10		
2SPO 100 120 090	2SPOC 100 120 090	10	120°	25	90	10		
2SPO 100 090 150	2SPOC 100 090 150	10	90°	25	150	10		
2SPO 100 120 150	2SPOC 100 120 150	10	120°	25	150	10		
2SPO 120 090 090	2SPOC 120 090 090	12	90°	30	90	12		
2SPO 120 120 090	2SPOC 120 120 090	12	120°	30	90	12		
2SPO 120 090 150	2SPOC 120 090 150	12	90°	30	150	12		
2SPO 120 120 150	2SPOC 120 120 150	12	120°	30	150	12		
2SPO 160 090 110	2SPOC 160 090 110	16	90°	35	110	16		
2SPO 160 120 110	2SPOC 160 120 110	16	120°	35	110	16		

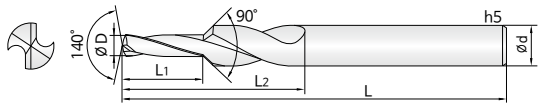

- 프리하든강, 일반강, 주물, 비철합금 가공 드릴
- 드릴링과 면취, 카운터 작업을 동시에 가공할 수 있는 다기능 드릴입니다.
- HR 코팅 처리하여 다양한 피삭재 가공시 인선부에 스트레스가 적으며 피삭재의 면조도가 향상됩니다
- 다양한 피삭재 영역에 적용이 가능합니다.
- Drills for pre-hardened steels, mild steels, cast irons and non-ferrous alloys
- A multifunctional drill capable of simultaneously processing drilling, chamfering, and counter operations.
- HR coating reduces stress on the edge and improves the surface of roughness of the workpiece.
- It can be applied to various of workpieces.

**2**

WC  
미립자

HR  
Coating

18°  
Helix Angle

140°

CUTTING  
DATA

509P

D Size	D Tolerance
$\phi 3.4 \sim 5.1$	+0 ~ -0.02mm
$\phi 6.9 \sim 10.3$	+0 ~ -0.025mm

단위 : mm

Order Number	날경 Diameter D	탭 TAP	날장 Length of cut L1	홈길이 Flute Length L2	전장 Overall Length L	샙크 Dia d	비고
2STD 034 080 S06	3.4	M4	8	22	75	6	
2STD 034 120 S06	3.4	M4	12	27	75	6	
2STD 043 100 S08	4.3	M5	10	25	80	8	
2STD 043 150 S08	4.3	M5	15	30	80	8	
2STD 051 120 S08	5.1	M6	12	30	90	8	
2STD 051 180 S08	5.1	M6	18	35	90	8	
2STD 069 160 S10	6.9	M8	16	40	90	10	
2STD 069 240 S10	6.9	M8	24	45	100	10	
2STD 086 200 S12	8.6	M10	20	45	110	12	
2STD 086 300 S12	8.6	M10	30	55	120	12	
2STD 103 240 S14	10.3	M12	24	50	110	14	
2STD 103 360 S14	10.3	M12	36	60	120	14	

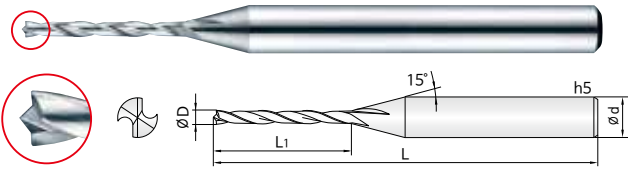

- 알루미늄, 구리, 비철합금, A.B.S수지, 레진 가공 드릴
- 버를 최소화하기 위한 스페셜한 드릴 헤드 형상을 설계하였습니다.
- 드릴링 작업시 피삭재 센터의 드릴링 워킹 현상을 방지하여 정확한 드릴링 위치와 홀 크기를 제공합니다.
- 극소형 드릴링에 최적화 된 포인트 설계로 안정적인 드릴링을 구현 합니다.

• Drills for aluminium, copper, non-ferrous alloys, A.B.S and resin

- Special drill head geometry designed to minimize burrs.
- The drill location and hole size are provided to prevent drill walking in the center of the workpiece during drilling.
- Implements stable drilling with a point design optimized for ultra-small drilling.



510P

D Size	D Tolerance
∅ 0.15 ~ 0.2	+0 ~ -0.005mm
∅ 0.21 ~ 3	+0 ~ -0.01mm
∅ 3.5 ~ 6	+0 ~ -0.015mm

단위 : mm

Order Number	날경 Diameter D	날장 Length of cut L1	전장 Overall Length L	샹크 Shank Dia d	비고	Order Number	날경 Diameter D	날장 Length of cut L1	전장 Overall Length L	샹크 Shank Dia d	비고
2DED 0015 009 S03	0.15	0.9	40	3		2DED 008 040 S03	0.8	4	40	3	
2DED 0015 018 S03	0.15	1.8	40	3		2DED 008 080 S03	0.8	8	40	3	
2DED 0016 009 S03	0.16	0.9	40	3		2DED 0085 040 S03	0.85	4	40	3	
2DED 0016 018 S03	0.16	1.8	40	3		2DED 0085 080 S03	0.85	8	40	3	
2DED 0017 009 S03	0.17	0.9	40	3		2DED 009 040 S03	0.9	4	40	3	
2DED 0017 018 S03	0.17	1.8	40	3		2DED 009 080 S03	0.9	8	40	3	
2DED 0018 0105 S03	0.18	1.05	40	3		2DED 0095 040 S03	0.95	4	40	3	
2DED 0018 021 S03	0.18	2.1	40	3		2DED 0095 080 S03	0.95	8	40	3	
2DED 0019 0105 S03	0.19	1.05	40	3		2DED 010 050 S03	1	5	40	3	
2DED 0019 021 S03	0.19	2.1	40	3		2DED 010 100 S03	1	10	40	3	
2DED 002 012 S03	0.2	1.2	40	3		2DED 011 050 S03	1.1	5	40	3	
2DED 002 024 S03	0.2	2.4	40	3		2DED 011 100 S03	1.1	10	40	3	
2DED 0021 012 S03	0.21	1.2	40	3		2DED 012 050 S03	1.2	5	40	3	
2DED 0021 024 S03	0.21	2.4	40	3		2DED 012 100 S03	1.2	10	40	3	
2DED 0022 013 S03	0.22	1.3	40	3		2DED 013 050 S03	1.3	5	40	3	
2DED 0022 026 S03	0.22	2.6	40	3		2DED 013 100 S03	1.3	10	40	3	
2DED 0023 013 S03	0.23	1.3	40	3		2DED 014 050 S03	1.4	5	40	3	
2DED 0023 026 S03	0.23	2.6	40	3		2DED 014 100 S03	1.4	10	40	3	
2DED 0024 013 S03	0.24	1.3	40	3		2DED 015 075 S03	1.5	7.5	45	3	
2DED 0024 026 S03	0.24	2.6	40	3		2DED 015 150 S03	1.5	15	45	3	
2DED 0025 015 S03	0.25	1.5	40	3		2DED 016 075 S03	1.6	7.5	45	3	
2DED 0025 030 S03	0.25	3	40	3		2DED 016 150 S03	1.6	15	45	3	
2DED 0026 015 S03	0.26	1.5	40	3		2DED 017 075 S03	1.7	7.5	45	3	
2DED 0026 030 S03	0.26	3	40	3		2DED 017 150 S03	1.7	15	45	3	
2DED 0027 015 S03	0.27	1.5	40	3		2DED 018 075 S03	1.8	7.5	45	3	
2DED 0027 030 S03	0.27	3	40	3		2DED 018 150 S03	1.8	15	45	3	
2DED 0028 0165 S03	0.28	1.65	40	3		2DED 019 075 S03	1.9	7.5	45	3	
2DED 0028 033 S03	0.28	3.3	40	3		2DED 019 150 S03	1.9	15	45	3	
2DED 0029 0165 S03	0.29	1.65	40	3		2DED 020 110 S03	2	11	50	3	
2DED 0029 033 S03	0.29	3.3	40	3		2DED 020 220 S03	2	22	50	3	
2DED 003 025 S03	0.3	2.5	40	3		2DED 021 110 S03	2.1	11	50	3	
2DED 003 050 S03	0.3	5	40	3		2DED 021 220 S03	2.1	22	50	3	
2DED 0035 025 S03	0.35	2.5	40	3		2DED 022 110 S03	2.2	11	50	3	
2DED 0035 050 S03	0.35	5	40	3		2DED 022 220 S03	2.2	22	50	3	
2DED 004 030 S03	0.4	3	40	3		2DED 023 110 S03	2.3	11	50	3	
2DED 004 060 S03	0.4	6	40	3		2DED 023 220 S03	2.3	22	50	3	
2DED 0045 030 S03	0.45	3	40	3		2DED 024 110 S03	2.4	11	50	3	
2DED 0045 060 S03	0.45	6	40	3		2DED 024 220 S03	2.4	22	50	3	
2DED 005 030 S03	0.5	3	40	3		2DED 025 110 S03	2.5	11	50	3	
2DED 005 060 S03	0.5	6	40	3		2DED 025 220 S03	2.5	22	50	3	
2DED 0055 030 S03	0.55	3	40	3		2DED 026 110 S03	2.6	11	50	3	
2DED 0055 060 S03	0.55	6	40	3		2DED 026 220 S03	2.6	22	50	3	
2DED 006 035 S03	0.6	3.5	40	3		2DED 027 125 S03	2.7	12.5	50	3	
2DED 006 070 S03	0.6	7	40	3		2DED 027 250 S03	2.7	25	50	3	
2DED 0065 035 S03	0.65	3.5	40	3		2DED 028 125 S03	2.8	12.5	50	3	
2DED 0065 070 S03	0.65	7	40	3		2DED 028 250 S03	2.8	25	50	3	
2DED 007 040 S03	0.7	4	40	3		2DED 029 125 S03	2.9	12.5	50	3	
2DED 007 080 S03	0.7	8	40	3		2DED 029 250 S03	2.9	25	50	3	
2DED 0075 040 S03	0.75	4	40	3		2DED 030 125 S03	3	12.5	50	3	
2DED 0075 080 S03	0.75	8	40	3		2DED 030 250 S03	3	25	50	3	



단위 : mm

Order Number	날경 Diameter D	날장 Length of cut L1	전장 Overall Length L	생크 Shank Dia d	비고	Order Number	날경 Diameter D	날장 Length of cut L1	전장 Overall Length L	생크 Shank Dia d	비고
2DED 035 175 S04	3.5	17.5	75	4							
2DED 035 350 S04	3.5	35	75	4							
2DED 040 200 S04	4	20	85	4							
2DED 040 400 S04	4	40	85	4							
2DED 045 210 S06	4.5	21	85	6							
2DED 045 420 S06	4.5	42	85	6							
2DED 050 225 S06	5	22.5	90	6							
2DED 050 450 S06	5	45	90	6							
2DED 055 225 S06	5.5	22.5	95	6							
2DED 055 450 S06	5.5	45	95	6							
2DED 060 250 S06	6	25	100	6							
2DED 060 500 S06	6	50	100	6							

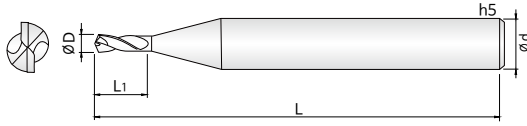

- 중저 탄소강, 동합금, 알루미늄용 고정도 드릴
- 다양한 규격으로 정밀 기계부품, IT부품 분야에 극소경 작업이 가능합니다.
- 특수한 인선처리로 뛰어난 고정도, 고능률 작업이 가능합니다.
- 저마찰과 내소착 및 이형성이 우수한 T-CRO코팅을 적용하여 내마모성이 뛰어납니다.

• High-precision drills for low to medium carbon steels, non-ferrous alloys, and aluminum

- Capable of ultra-precision work in the field of precision mechanical components and IT components with various specifications.
- Excellent precision and high-efficiency operations are possible with special edge treatment.
- Outstanding wear resistance with the application of T-CRO coating, which has low friction, superior adhesion resistance, and deformability.



510P

단위 : mm

Order Number	날경 Diameter D	홈길이 Flute Length L1	전장 Overall Length L	샙크 Shank Dia d	비고	Order Number	날경 Diameter D	홈길이 Flute Length L1	전장 Overall Length L	샙크 Shank Dia d	비고
2MID 005 015 S03	0.5	1.5	40	3		2MID 025 075 S03	2.5	7.5	40	3	
2MID 005 025 S03	0.5	2.5	40	3		2MID 0255 078 S03	2.55	7.8	40	3	
2MID 0055 018 S03	0.55	1.8	40	3		2MID 026 078 S03	2.6	7.8	40	3	
2MID 0055 030 S03	0.55	3	40	3		2MID 0265 081 S03	2.65	8.1	40	3	
2MID 006 018 S03	0.6	1.8	40	3		2MID 027 081 S03	2.7	8.1	40	3	
2MID 006 030 S03	0.6	3	40	3		2MID 0275 084 S03	2.75	8.4	40	3	
2MID 0065 021 S03	0.65	2.1	40	3		2MID 028 084 S03	2.8	8.4	40	3	
2MID 0065 035 S03	0.65	3.5	40	3		2MID 0285 087 S03	2.85	8.7	40	3	
2MID 007 021 S03	0.7	2.1	40	3		2MID 029 087 S03	2.9	8.7	40	3	
2MID 007 035 S03	0.7	3.5	40	3		2MID 0295 090 S03	2.95	9	40	3	
2MID 0075 024 S03	0.75	2.4	40	3		2MID 030 090 S03	3	9	40	3	
2MID 0075 040 S03	0.75	4	40	3							
2MID 008 024 S03	0.8	2.4	40	3							
2MID 008 040 S03	0.8	4	40	3							
2MID 0085 027 S03	0.85	2.7	40	3							
2MID 0085 045 S03	0.85	4.5	40	3							
2MID 009 027 S03	0.9	2.7	40	3							
2MID 009 045 S03	0.9	4.5	40	3							
2MID 0095 030 S03	0.95	3	40	3							
2MID 0095 050 S03	0.95	5	40	3							
2MID 010 030 S03	1	3	40	3							
2MID 0105 033 S03	1.05	3.3	40	3							
2MID 011 033 S03	1.1	3.3	40	3							
2MID 0115 036 S03	1.15	3.6	40	3							
2MID 012 036 S03	1.2	3.6	40	3							
2MID 0125 039 S03	1.25	3.9	40	3							
2MID 013 039 S03	1.3	3.9	40	3							
2MID 0135 042 S03	1.35	4.2	40	3							
2MID 014 042 S03	1.4	4.2	40	3							
2MID 0145 045 S03	1.45	4.5	40	3							
2MID 015 045 S03	1.5	4.5	40	3							
2MID 0155 048 S03	1.55	4.8	40	3							
2MID 016 048 S03	1.6	4.8	40	3							
2MID 0165 051 S03	1.65	5.1	40	3							
2MID 017 051 S03	1.7	5.1	40	3							
2MID 0175 054 S03	1.75	5.4	40	3							
2MID 018 054 S03	1.8	5.4	40	3							
2MID 0185 057 S03	1.85	5.7	40	3							
2MID 019 057 S03	1.9	5.7	40	3							
2MID 0195 060 S03	1.95	6	40	3							
2MID 020 060 S03	2	6	40	3							
2MID 0205 063 S03	2.05	6.3	40	3							
2MID 021 063 S03	2.1	6.3	40	3							
2MID 0215 066 S03	2.15	6.6	40	3							
2MID 022 066 S03	2.2	6.6	40	3							
2MID 0225 069 S03	2.25	6.9	40	3							
2MID 023 069 S03	2.3	6.9	40	3							
2MID 0235 072 S03	2.35	7.2	40	3							
2MID 024 072 S03	2.4	7.2	40	3							
2MID 0245 075 S03	2.45	7.5	40	3							

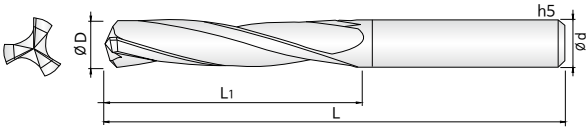

- 고경도강(HRc52~65), 열처리강 계열의 강력 드릴
- HR코팅으로 내열성과 내마모성이 우수, 긴 공구수명을 실현 하였습니다.
- 칩핑을 최소화 하는 Point thinning을 적용 하였습니다.
- 140도와 90도의 선단각과 최적의 플루트 형상 설계로 공구의 성능을 극대화하였습니다.
- 칩 배출력과 드릴의 강성을 고려한 플루트 홈 설계로 안정적인 드릴링을 구현합니다.

### Powerful drills for hardened steels(HRc52~65) and heat-treated steels

- Longer tool life HR coating which provides excellent heat resistance and wear resistance.
- Point thinning was applied to minimize chipping.
- With an optimal flute design and 90 and 140-degree point angle, the tool's performance is maximized.
- Implements stable drilling with a flute groove design considering chip evacuation and drill rigidity.



511P

단위 : mm

Order Number	날경 Diameter D	홈길이 Flute Length L1	전장 Overall Length L	샙크 Shank Dia d	비고	Order Number	날경 Diameter D	홈길이 Flute Length L1	전장 Overall Length L	샙크 Shank Dia d	비고
3DUBEH 010 060 S03	1	6	40	3		3DUBEH 060 270 S06	6	27	65	6	
3DUBEH 011 060 S03	1.1	6	40	3		3DUBEH 061 310 S08	6.1	31	75	8	
3DUBEH 012 060 S03	1.2	6	40	3		3DUBEH 062 310 S08	6.2	31	75	8	
3DUBEH 013 080 S03	1.3	8	40	3		3DUBEH 063 310 S08	6.3	31	75	8	
3DUBEH 014 080 S03	1.4	8	40	3		3DUBEH 064 310 S08	6.4	31	75	8	
3DUBEH 015 080 S03	1.5	8	40	3		3DUBEH 065 310 S08	6.5	31	75	8	
3DUBEH 016 100 S03	1.6	10	40	3		3DUBEH 066 330 S08	6.6	33	75	8	
3DUBEH 017 100 S03	1.7	10	40	3		3DUBEH 067 330 S08	6.7	33	75	8	
3DUBEH 018 100 S03	1.8	10	40	3		3DUBEH 068 330 S08	6.8	33	75	8	
3DUBEH 019 100 S03	1.9	10	40	3		3DUBEH 069 330 S08	6.9	33	75	8	
3DUBEH 020 120 S03	2	12	45	3		3DUBEH 070 330 S08	7	33	75	8	
3DUBEH 021 120 S03	2.1	12	45	3		3DUBEH 071 330 S08	7.1	33	80	8	
3DUBEH 022 120 S03	2.2	12	45	3		3DUBEH 072 330 S08	7.2	33	80	8	
3DUBEH 023 120 S03	2.3	12	45	3		3DUBEH 073 330 S08	7.3	33	80	8	
3DUBEH 024 120 S03	2.4	12	45	3		3DUBEH 074 330 S08	7.4	33	80	8	
3DUBEH 025 130 S03	2.5	13	45	3		3DUBEH 075 330 S08	7.5	33	80	8	
3DUBEH 026 130 S03	2.6	13	45	3		3DUBEH 076 360 S08	7.6	36	80	8	
3DUBEH 027 130 S03	2.7	13	45	3		3DUBEH 077 360 S08	7.7	36	80	8	
3DUBEH 028 130 S03	2.8	13	45	3		3DUBEH 078 360 S08	7.8	36	80	8	
3DUBEH 029 130 S03	2.9	13	45	3		3DUBEH 079 360 S08	7.9	36	80	8	
3DUBEH 030 130 S03	3	13	45	3		3DUBEH 080 360 S08	8	36	80	8	
3DUBEH 031 190 S04	3.1	19	55	4		3DUBEH 081 360 S10	8.1	36	85	10	
3DUBEH 032 190 S04	3.2	19	55	4		3DUBEH 082 360 S10	8.2	36	85	10	
3DUBEH 033 190 S04	3.3	19	55	4		3DUBEH 083 360 S10	8.3	36	85	10	
3DUBEH 034 190 S04	3.4	19	55	4		3DUBEH 084 360 S10	8.4	36	85	10	
3DUBEH 035 190 S04	3.5	19	55	4		3DUBEH 085 360 S10	8.5	36	85	10	
3DUBEH 036 210 S04	3.6	21	55	4		3DUBEH 086 380 S10	8.6	38	85	10	
3DUBEH 037 210 S04	3.7	21	55	4		3DUBEH 087 380 S10	8.7	38	85	10	
3DUBEH 038 210 S04	3.8	21	55	4		3DUBEH 088 380 S10	8.8	38	85	10	
3DUBEH 039 210 S04	3.9	21	55	4		3DUBEH 089 380 S10	8.9	38	85	10	
3DUBEH 040 210 S04	4	21	55	4		3DUBEH 090 380 S10	9	38	85	10	
3DUBEH 041 230 S06	4.1	23	60	6		3DUBEH 091 380 S10	9.1	38	90	10	
3DUBEH 042 230 S06	4.2	23	60	6		3DUBEH 092 380 S10	9.2	38	90	10	
3DUBEH 043 230 S06	4.3	23	60	6		3DUBEH 093 380 S10	9.3	38	90	10	
3DUBEH 044 230 S06	4.4	23	60	6		3DUBEH 094 380 S10	9.4	38	90	10	
3DUBEH 045 230 S06	4.5	23	60	6		3DUBEH 095 380 S10	9.5	38	90	10	
3DUBEH 046 250 S06	4.6	25	60	6		3DUBEH 096 410 S10	9.6	41	90	10	
3DUBEH 047 250 S06	4.7	25	60	6		3DUBEH 097 410 S10	9.7	41	90	10	
3DUBEH 048 250 S06	4.8	25	60	6		3DUBEH 098 410 S10	9.8	41	90	10	
3DUBEH 049 250 S06	4.9	25	60	6		3DUBEH 099 410 S10	9.9	41	90	10	
3DUBEH 050 250 S06	5	25	60	6		3DUBEH 100 410 S10	10	41	90	10	
3DUBEH 051 250 S06	5.1	25	65	6		3DUBEH 101 410 S12	10.1	41	95	12	
3DUBEH 052 250 S06	5.2	25	65	6		3DUBEH 102 410 S12	10.2	41	95	12	
3DUBEH 053 250 S06	5.3	25	65	6		3DUBEH 103 410 S12	10.3	41	95	12	
3DUBEH 054 250 S06	5.4	25	65	6		3DUBEH 104 410 S12	10.4	41	95	12	
3DUBEH 055 250 S06	5.5	25	65	6		3DUBEH 105 410 S12	10.5	41	95	12	
3DUBEH 056 270 S06	5.6	27	65	6		3DUBEH 106 450 S12	10.6	45	95	12	
3DUBEH 057 270 S06	5.7	27	65	6		3DUBEH 107 450 S12	10.7	45	95	12	
3DUBEH 058 270 S06	5.8	27	65	6		3DUBEH 108 450 S12	10.8	45	95	12	
3DUBEH 059 270 S06	5.9	27	65	6		3DUBEH 109 450 S12	10.9	45	95	12	



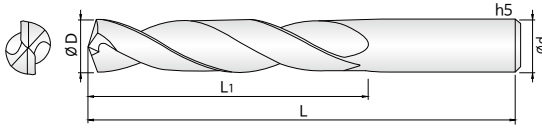

- HRC48이하, NAK, SCM, 열처리강용 강력 드릴
- 우수한 내마모성의 HR코팅을 적용하여 장시간 가공에 적합합니다.
- 절삭 저항을 최소화하는 Point thinning을 채택 하였습니다.
- 열 배출의 최적화 된 형상으로 안정적인 공구의 수명을 유지합니다.
- 칩 배출력과 드릴의 강성을 고려한 플루트 홈 설계를 적용하여 우수한 칩배출을 실현합니다.

- Powerful drills for materials up to HRC48, NAK, SCM, and heat-treated steels
- Suitable for long-term machining with excellent wear resistance HR coating.
- Adopted Point thinning to minimize cutting resistance.
- Maintains the stable lifespan of the tool with an optimized shape for heat dissipation.
- Achieves excellent chip evacuation with flute groove design considering chip evacuation and drill rigidity.



512P

단위 : mm

Order Number	날경 Diameter D	홈길이 Flute Length L1	전장 Overall Length L	샙크 Shank Dia d	비고	Order Number	날경 Diameter D	홈길이 Flute Length L1	전장 Overall Length L	샙크 Shank Dia d	비고
2DUBES 010 080 S03	1	8	40	3		2DUBES 060 280 S06	6	28	65	6	
2DUBES 011 080 S03	1.1	8	40	3		2DUBES 061 340 S08	6.1	34	80	8	
2DUBES 012 080 S03	1.2	8	40	3		2DUBES 062 340 S08	6.2	34	80	8	
2DUBES 013 080 S03	1.3	8	40	3		2DUBES 063 340 S08	6.3	34	80	8	
2DUBES 014 080 S03	1.4	8	40	3		2DUBES 064 340 S08	6.4	34	80	8	
2DUBES 015 080 S03	1.5	8	50	3		2DUBES 065 340 S08	6.5	34	80	8	
2DUBES 016 080 S03	1.6	8	50	3		2DUBES 066 340 S08	6.6	34	80	8	
2DUBES 017 100 S03	1.7	10	50	3		2DUBES 067 340 S08	6.7	34	80	8	
2DUBES 018 100 S03	1.8	10	50	3		2DUBES 068 340 S08	6.8	34	80	8	
2DUBES 019 100 S03	1.9	10	50	3		2DUBES 069 340 S08	6.9	34	80	8	
2DUBES 020 160 S04	2	16	50	4		2DUBES 070 340 S08	7	34	80	8	
2DUBES 021 160 S04	2.1	16	50	4		2DUBES 071 410 S08	7.1	41	80	8	
2DUBES 022 160 S04	2.2	16	50	4		2DUBES 072 410 S08	7.2	41	80	8	
2DUBES 023 160 S04	2.3	16	50	4		2DUBES 073 410 S08	7.3	41	80	8	
2DUBES 024 160 S04	2.4	16	50	4		2DUBES 074 410 S08	7.4	41	80	8	
2DUBES 025 200 S04	2.5	20	50	4		2DUBES 075 410 S08	7.5	41	80	8	
2DUBES 026 200 S04	2.6	20	50	4		2DUBES 076 410 S08	7.6	41	80	8	
2DUBES 027 200 S04	2.7	20	50	4		2DUBES 077 410 S08	7.7	41	80	8	
2DUBES 028 200 S04	2.8	20	50	4		2DUBES 078 410 S08	7.8	41	80	8	
2DUBES 029 200 S04	2.9	20	50	4		2DUBES 079 410 S08	7.9	41	80	8	
2DUBES 030 200 S06	3	20	60	6		2DUBES 080 410 S08	8	41	80	8	
2DUBES 031 200 S06	3.1	20	60	6		2DUBES 081 470 S10	8.1	47	90	10	
2DUBES 032 200 S06	3.2	20	60	6		2DUBES 082 470 S10	8.2	47	90	10	
2DUBES 033 200 S06	3.3	20	60	6		2DUBES 083 470 S10	8.3	47	90	10	
2DUBES 034 200 S06	3.4	20	60	6		2DUBES 084 470 S10	8.4	47	90	10	
2DUBES 035 200 S06	3.5	20	60	6		2DUBES 085 470 S10	8.5	47	90	10	
2DUBES 036 200 S06	3.6	20	60	6		2DUBES 086 470 S10	8.6	47	90	10	
2DUBES 037 200 S06	3.7	20	60	6		2DUBES 087 470 S10	8.7	47	90	10	
2DUBES 038 240 S06	3.8	24	65	6		2DUBES 088 470 S10	8.8	47	90	10	
2DUBES 039 240 S06	3.9	24	65	6		2DUBES 089 470 S10	8.9	47	90	10	
2DUBES 040 240 S06	4	24	65	6		2DUBES 090 470 S10	9	47	90	10	
2DUBES 041 240 S06	4.1	24	65	6		2DUBES 091 470 S10	9.1	47	90	10	
2DUBES 042 240 S06	4.2	24	65	6		2DUBES 092 470 S10	9.2	47	90	10	
2DUBES 043 240 S06	4.3	24	65	6		2DUBES 093 470 S10	9.3	47	90	10	
2DUBES 044 240 S06	4.4	24	65	6		2DUBES 094 470 S10	9.4	47	90	10	
2DUBES 045 240 S06	4.5	24	65	6		2DUBES 095 470 S10	9.5	47	90	10	
2DUBES 046 240 S06	4.6	24	65	6		2DUBES 096 470 S10	9.6	47	90	10	
2DUBES 047 240 S06	4.7	24	65	6		2DUBES 097 470 S10	9.7	47	90	10	
2DUBES 048 280 S06	4.8	28	65	6		2DUBES 098 470 S10	9.8	47	90	10	
2DUBES 049 280 S06	4.9	28	65	6		2DUBES 099 470 S10	9.9	47	90	10	
2DUBES 050 280 S06	5	28	65	6		2DUBES 100 470 S10	10	47	90	10	
2DUBES 051 280 S06	5.1	28	65	6		2DUBES 101 550 S12	10.1	55	100	12	
2DUBES 052 280 S06	5.2	28	65	6		2DUBES 102 550 S12	10.2	55	100	12	
2DUBES 053 280 S06	5.3	28	65	6		2DUBES 103 550 S12	10.3	55	100	12	
2DUBES 054 280 S06	5.4	28	65	6		2DUBES 104 550 S12	10.4	55	100	12	
2DUBES 055 280 S06	5.5	28	65	6		2DUBES 105 550 S12	10.5	55	100	12	
2DUBES 056 280 S06	5.6	28	65	6		2DUBES 106 550 S12	10.6	55	100	12	
2DUBES 057 280 S06	5.7	28	65	6		2DUBES 107 550 S12	10.7	55	100	12	
2DUBES 058 280 S06	5.8	28	65	6		2DUBES 108 550 S12	10.8	55	100	12	
2DUBES 059 280 S06	5.9	28	65	6		2DUBES 109 550 S12	10.9	55	100	12	



단위 : mm

Order Number	날경 Diameter D	홈길이 Flute Length L1	전장 Overall Length L	샙크 Dia d	비고	Order Number	날경 Diameter D	홈길이 Flute Length L1	전장 Overall Length L	샙크 Dia d	비고
2DUBES 110 550 S12	11	55	100	12		2DUBES 160 650 S16	16	65	115	16	
2DUBES 111 550 S12	11.1	55	100	12		2DUBES 161 730 S18	16.1	73	125	18	
2DUBES 112 550 S12	11.2	55	100	12		2DUBES 162 730 S18	16.2	73	125	18	
2DUBES 113 550 S12	11.3	55	100	12		2DUBES 163 730 S18	16.3	73	125	18	
2DUBES 114 550 S12	11.4	55	100	12		2DUBES 164 730 S18	16.4	73	125	18	
2DUBES 115 550 S12	11.5	55	100	12		2DUBES 165 730 S18	16.5	73	125	18	
2DUBES 116 550 S12	11.6	55	100	12		2DUBES 166 730 S18	16.6	73	125	18	
2DUBES 117 550 S12	11.7	55	100	12		2DUBES 167 730 S18	16.7	73	125	18	
2DUBES 118 550 S12	11.8	55	100	12		2DUBES 168 730 S18	16.8	73	125	18	
2DUBES 119 550 S12	11.9	55	100	12		2DUBES 169 730 S18	16.9	73	125	18	
2DUBES 120 550 S12	12	55	100	12		2DUBES 170 730 S18	17	73	125	18	
2DUBES 121 600 S14	12.1	60	100	14		2DUBES 171 730 S18	17.1	73	125	18	
2DUBES 122 600 S14	12.2	60	100	14		2DUBES 172 730 S18	17.2	73	125	18	
2DUBES 123 600 S14	12.3	60	100	14		2DUBES 173 730 S18	17.3	73	125	18	
2DUBES 124 600 S14	12.4	60	100	14		2DUBES 174 730 S18	17.4	73	125	18	
2DUBES 125 600 S14	12.5	60	100	14		2DUBES 175 730 S18	17.5	73	125	18	
2DUBES 126 600 S14	12.6	60	100	14		2DUBES 176 730 S18	17.6	73	125	18	
2DUBES 127 600 S14	12.7	60	100	14		2DUBES 177 730 S18	17.7	73	125	18	
2DUBES 128 600 S14	12.8	60	100	14		2DUBES 178 730 S18	17.8	73	125	18	
2DUBES 129 600 S14	12.9	60	100	14		2DUBES 179 730 S18	17.9	73	125	18	
2DUBES 130 600 S14	13	60	100	14		2DUBES 180 730 S18	18	73	125	18	
2DUBES 131 600 S14	13.1	60	100	14		2DUBES 181 790 S20	18.1	79	130	20	
2DUBES 132 600 S14	13.2	60	105	14		2DUBES 182 790 S20	18.2	79	130	20	
2DUBES 133 600 S14	13.3	60	105	14		2DUBES 183 790 S20	18.3	79	130	20	
2DUBES 134 600 S14	13.4	60	105	14		2DUBES 184 790 S20	18.4	79	130	20	
2DUBES 135 600 S14	13.5	60	105	14		2DUBES 185 790 S20	18.5	79	130	20	
2DUBES 136 600 S14	13.6	60	105	14		2DUBES 186 790 S20	18.6	79	130	20	
2DUBES 137 600 S14	13.7	60	105	14		2DUBES 187 790 S20	18.7	79	130	20	
2DUBES 138 600 S14	13.8	60	105	14		2DUBES 188 790 S20	18.8	79	130	20	
2DUBES 139 600 S14	13.9	60	105	14		2DUBES 189 790 S20	18.9	79	130	20	
2DUBES 140 600 S14	14	60	105	14		2DUBES 190 790 S20	19	79	130	20	
2DUBES 141 650 S16	14.1	65	110	16		2DUBES 191 790 S20	19.1	79	130	20	
2DUBES 142 650 S16	14.2	65	110	16		2DUBES 192 790 S20	19.2	79	130	20	
2DUBES 143 650 S16	14.3	65	110	16		2DUBES 193 790 S20	19.3	79	130	20	
2DUBES 144 650 S16	14.4	65	110	16		2DUBES 194 790 S20	19.4	79	130	20	
2DUBES 145 650 S16	14.5	65	110	16		2DUBES 195 790 S20	19.5	79	130	20	
2DUBES 146 650 S16	14.6	65	110	16		2DUBES 196 790 S20	19.6	79	130	20	
2DUBES 147 650 S16	14.7	65	110	16		2DUBES 197 790 S20	19.7	79	130	20	
2DUBES 148 650 S16	14.8	65	110	16		2DUBES 198 790 S20	19.8	79	130	20	
2DUBES 149 650 S16	14.9	65	110	16		2DUBES 199 790 S20	19.9	79	130	20	
2DUBES 150 650 S16	15	65	110	16		2DUBES 200 790 S20	20	79	130	20	
2DUBES 151 650 S16	15.1	65	110	16							
2DUBES 152 650 S16	15.2	65	115	16							
2DUBES 153 650 S16	15.3	65	115	16							
2DUBES 154 650 S16	15.4	65	115	16							
2DUBES 155 650 S16	15.5	65	115	16							
2DUBES 156 650 S16	15.6	65	115	16							
2DUBES 157 650 S16	15.7	65	115	16							
2DUBES 158 650 S16	15.8	65	115	16							
2DUBES 159 650 S16	15.9	65	115	16							

## 초경 2날 두배 S 드릴 [5XD]

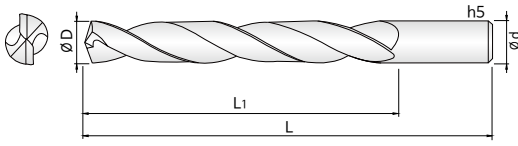

- HRC48이하, NAK, SCM, 열처리강용 강력 드릴
- 우수한 내마모성의 HR코팅을 적용하여 장시간 가공에 적합합니다.
- 절삭 저항을 최소화하는 Point thinning을 채택 하였습니다.
- 열 배출의 최적화 된 형상으로 안정적인 공구의 수명을 유지합니다.
- 칩 배출력과 드릴의 강성을 고려한 플루트 홈 설계를 적용하여 우수한 칩배출을 실현합니다.
- Powerful drills for materials up to HRC48, NAK, SCM, and heat-treated steels
- Suitable for long-term machining with excellent wear resistance HR coating.
- Adopted Point thinning to minimize cutting resistance.
- Maintains the stable lifespan of the tool with an optimized shape for heat dissipation.
- Achieves excellent chip evacuation with flute groove design considering chip evacuation and drill rigidity.



512P

단위 : mm

Order Number	날경 Diameter D	홈길이 Flute Length L1	전장 Overall Length L	샙크 Shank Dia d	비고	Order Number	날경 Diameter D	홈길이 Flute Length L1	전장 Overall Length L	샙크 Shank Dia d	비고
2DUBES 010 100 S03	1	10	55	3		2DUBES 060 440 S06	6	44	80	6	
2DUBES 011 120 S03	1.1	12	55	3		2DUBES 061 530 S08	6.1	53	90	8	
2DUBES 012 120 S03	1.2	12	55	3		2DUBES 062 530 S08	6.2	53	90	8	
2DUBES 013 120 S03	1.3	12	55	3		2DUBES 063 530 S08	6.3	53	90	8	
2DUBES 014 120 S03	1.4	12	55	3		2DUBES 064 530 S08	6.4	53	90	8	
2DUBES 015 120 S03	1.5	12	55	3		2DUBES 065 530 S08	6.5	53	90	8	
2DUBES 016 160 S03	1.6	16	55	3		2DUBES 066 530 S08	6.6	53	90	8	
2DUBES 017 160 S03	1.7	16	55	3		2DUBES 067 530 S08	6.7	53	90	8	
2DUBES 018 160 S03	1.8	16	55	3		2DUBES 068 530 S08	6.8	53	90	8	
2DUBES 019 160 S03	1.9	16	55	3		2DUBES 069 530 S08	6.9	53	90	8	
2DUBES 020 210 S04	2	21	55	4		2DUBES 070 530 S08	7	53	90	8	
2DUBES 021 210 S04	2.1	21	55	4		2DUBES 071 530 S08	7.1	53	90	8	
2DUBES 022 210 S04	2.2	21	55	4		2DUBES 072 530 S08	7.2	53	90	8	
2DUBES 023 210 S04	2.3	21	55	4		2DUBES 073 530 S08	7.3	53	90	8	
2DUBES 024 210 S04	2.4	21	55	4		2DUBES 074 530 S08	7.4	53	90	8	
2DUBES 025 210 S04	2.5	21	55	4		2DUBES 075 530 S08	7.5	53	90	8	
2DUBES 026 210 S04	2.6	21	55	4		2DUBES 076 530 S08	7.6	53	90	8	
2DUBES 027 210 S04	2.7	21	55	4		2DUBES 077 530 S08	7.7	53	90	8	
2DUBES 028 210 S04	2.8	21	55	4		2DUBES 078 530 S08	7.8	53	90	8	
2DUBES 029 210 S04	2.9	21	55	4		2DUBES 079 530 S08	7.9	53	90	8	
2DUBES 030 280 S06	3	28	65	6		2DUBES 080 530 S08	8	53	90	8	
2DUBES 031 280 S06	3.1	28	65	6		2DUBES 081 610 S10	8.1	61	105	10	
2DUBES 032 280 S06	3.2	28	65	6		2DUBES 082 610 S10	8.2	61	105	10	
2DUBES 033 280 S06	3.3	28	65	6		2DUBES 083 610 S10	8.3	61	105	10	
2DUBES 034 280 S06	3.4	28	65	6		2DUBES 084 610 S10	8.4	61	105	10	
2DUBES 035 280 S06	3.5	28	65	6		2DUBES 085 610 S10	8.5	61	105	10	
2DUBES 036 280 S06	3.6	28	65	6		2DUBES 086 610 S10	8.6	61	105	10	
2DUBES 037 280 S06	3.7	28	65	6		2DUBES 087 610 S10	8.7	61	105	10	
2DUBES 038 360 S06	3.8	36	75	6		2DUBES 088 610 S10	8.8	61	105	10	
2DUBES 039 360 S06	3.9	36	75	6		2DUBES 089 610 S10	8.9	61	105	10	
2DUBES 040 360 S06	4	36	75	6		2DUBES 090 610 S10	9	61	105	10	
2DUBES 041 360 S06	4.1	36	75	6		2DUBES 091 610 S10	9.1	61	105	10	
2DUBES 042 360 S06	4.2	36	75	6		2DUBES 092 610 S10	9.2	61	105	10	
2DUBES 043 360 S06	4.3	36	75	6		2DUBES 093 610 S10	9.3	61	105	10	
2DUBES 044 360 S06	4.4	36	75	6		2DUBES 094 610 S10	9.4	61	105	10	
2DUBES 045 360 S06	4.5	36	75	6		2DUBES 095 610 S10	9.5	61	105	10	
2DUBES 046 360 S06	4.6	36	75	6		2DUBES 096 610 S10	9.6	61	105	10	
2DUBES 047 360 S06	4.7	36	75	6		2DUBES 097 610 S10	9.7	61	105	10	
2DUBES 048 440 S06	4.8	44	80	6		2DUBES 098 610 S10	9.8	61	105	10	
2DUBES 049 440 S06	4.9	44	80	6		2DUBES 099 610 S10	9.9	61	105	10	
2DUBES 050 440 S06	5	44	80	6		2DUBES 100 610 S10	10	61	105	10	
2DUBES 051 440 S06	5.1	44	80	6		2DUBES 101 710 S12	10.1	71	120	12	
2DUBES 052 440 S06	5.2	44	80	6		2DUBES 102 710 S12	10.2	71	120	12	
2DUBES 053 440 S06	5.3	44	80	6		2DUBES 103 710 S12	10.3	71	120	12	
2DUBES 054 440 S06	5.4	44	80	6		2DUBES 104 710 S12	10.4	71	120	12	
2DUBES 055 440 S06	5.5	44	80	6		2DUBES 105 710 S12	10.5	71	120	12	
2DUBES 056 440 S06	5.6	44	80	6		2DUBES 106 710 S12	10.6	71	120	12	
2DUBES 057 440 S06	5.7	44	80	6		2DUBES 107 710 S12	10.7	71	120	12	
2DUBES 058 440 S06	5.8	44	80	6		2DUBES 108 710 S12	10.8	71	120	12	
2DUBES 059 440 S06	5.9	44	80	6		2DUBES 109 710 S12	10.9	71	120	12	

단위 : mm

Order Number	날경 Diameter D	홈길이 Flute Length L1	전장 Overall Length L	샙크 Dia d	비고	Order Number	날경 Diameter D	홈길이 Flute Length L1	전장 Overall Length L	샙크 Dia d	비고
2DUBES 110 710 S12	11	71	120	12		2DUBES 160 830 S16	16	83	135	16	
2DUBES 111 710 S12	11.1	71	120	12		2DUBES 161 930 S18	16.1	93	145	18	
2DUBES 112 710 S12	11.2	71	120	12		2DUBES 162 930 S18	16.2	93	145	18	
2DUBES 113 710 S12	11.3	71	120	12		2DUBES 163 930 S18	16.3	93	145	18	
2DUBES 114 710 S12	11.4	71	120	12		2DUBES 164 930 S18	16.4	93	145	18	
2DUBES 115 710 S12	11.5	71	120	12		2DUBES 165 930 S18	16.5	93	145	18	
2DUBES 116 710 S12	11.6	71	120	12		2DUBES 166 930 S18	16.6	93	145	18	
2DUBES 117 710 S12	11.7	71	120	12		2DUBES 167 930 S18	16.7	93	145	18	
2DUBES 118 710 S12	11.8	71	120	12		2DUBES 168 930 S18	16.8	93	145	18	
2DUBES 119 710 S12	11.9	71	120	12		2DUBES 169 930 S18	16.9	93	145	18	
2DUBES 120 710 S12	12	71	120	12		2DUBES 170 930 S18	17	93	145	18	
2DUBES 121 770 S14	12.1	77	125	14		2DUBES 171 930 S18	17.1	93	145	18	
2DUBES 122 770 S14	12.2	77	125	14		2DUBES 172 930 S18	17.2	93	145	18	
2DUBES 123 770 S14	12.3	77	125	14		2DUBES 173 930 S18	17.3	93	145	18	
2DUBES 124 770 S14	12.4	77	125	14		2DUBES 174 930 S18	17.4	93	145	18	
2DUBES 125 770 S14	12.5	77	125	14		2DUBES 175 930 S18	17.5	93	145	18	
2DUBES 126 770 S14	12.6	77	125	14		2DUBES 176 930 S18	17.6	93	145	18	
2DUBES 127 770 S14	12.7	77	125	14		2DUBES 177 930 S18	17.7	93	145	18	
2DUBES 128 770 S14	12.8	77	125	14		2DUBES 178 930 S18	17.8	93	145	18	
2DUBES 129 770 S14	12.9	77	125	14		2DUBES 179 930 S18	17.9	93	145	18	
2DUBES 130 770 S14	13	77	125	14		2DUBES 180 930 S18	18	93	145	18	
2DUBES 131 770 S14	13.1	77	125	14		2DUBES 181 1010 S20	18.1	101	155	20	
2DUBES 132 770 S14	13.2	77	125	14		2DUBES 182 1010 S20	18.2	101	155	20	
2DUBES 133 770 S14	13.3	77	125	14		2DUBES 183 1010 S20	18.3	101	155	20	
2DUBES 134 770 S14	13.4	77	125	14		2DUBES 184 1010 S20	18.4	101	155	20	
2DUBES 135 770 S14	13.5	77	125	14		2DUBES 185 1010 S20	18.5	101	155	20	
2DUBES 136 770 S14	13.6	77	125	14		2DUBES 186 1010 S20	18.6	101	155	20	
2DUBES 137 770 S14	13.7	77	125	14		2DUBES 187 1010 S20	18.7	101	155	20	
2DUBES 138 770 S14	13.8	77	125	14		2DUBES 188 1010 S20	18.8	101	155	20	
2DUBES 139 770 S14	13.9	77	125	14		2DUBES 189 1010 S20	18.9	101	155	20	
2DUBES 140 770 S14	14	77	125	14		2DUBES 190 1010 S20	19	101	155	20	
2DUBES 141 830 S16	14.1	83	135	16		2DUBES 191 1010 S20	19.1	101	155	20	
2DUBES 142 830 S16	14.2	83	135	16		2DUBES 192 1010 S20	19.2	101	155	20	
2DUBES 143 830 S16	14.3	83	135	16		2DUBES 193 1010 S20	19.3	101	155	20	
2DUBES 144 830 S16	14.4	83	135	16		2DUBES 194 1010 S20	19.4	101	155	20	
2DUBES 145 830 S16	14.5	83	135	16		2DUBES 195 1010 S20	19.5	101	155	20	
2DUBES 146 830 S16	14.6	83	135	16		2DUBES 196 1010 S20	19.6	101	155	20	
2DUBES 147 830 S16	14.7	83	135	16		2DUBES 197 1010 S20	19.7	101	155	20	
2DUBES 148 830 S16	14.8	83	135	16		2DUBES 198 1010 S20	19.8	101	155	20	
2DUBES 149 830 S16	14.9	83	135	16		2DUBES 199 1010 S20	19.9	101	155	20	
2DUBES 150 830 S16	15	83	135	16		2DUBES 200 1010 S20	20	101	155	20	
2DUBES 151 830 S16	15.1	83	135	16							
2DUBES 152 830 S16	15.2	83	135	16							
2DUBES 153 830 S16	15.3	83	135	16							
2DUBES 154 830 S16	15.4	83	135	16							
2DUBES 155 830 S16	15.5	83	135	16							
2DUBES 156 830 S16	15.6	83	135	16							
2DUBES 157 830 S16	15.7	83	135	16							
2DUBES 158 830 S16	15.8	83	135	16							
2DUBES 159 830 S16	15.9	83	135	16							

## 초경 2날 짧은 길이 두배 드릴

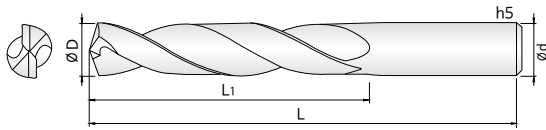

- HRC28이하, S45C, SCM, 주강, 주철용 고정밀 드릴
- T-CRO 코팅을 적용하여 드릴 가공 시 발생하는 윤착 현상을 최소화 하였습니다.
- 절삭 저항을 최소화하는 Point thinning을 채택 하였습니다.
- 특수 인선처리와 최적의 형상으로 치핑 및 돌발파손을 방지합니다.
- 우수한 공구의 강성과 칩 배출의 설계를 적용하여 칩 배출성을 향상시켰습니다.

- High-speed drills for materials up to HRC28, S45C, SCM, cast steels, and cast irons
- Minimized adhesion during drilling operations by applying T-CRO coating.
- Adopted point thinning to minimize cutting resistance.
- Prevents chipping and unexpected fractures with special edge treatment and optimal shape.
- Enhanced chip evacuation with the application of a design for superior tool rigidity and chip evacuation.



513P

단위 : mm

Order Number	날경 Diameter D	홀길이 Flute Length L1	전장 Overall Length L	샹크 Shank Dia d	비고	Order Number	날경 Diameter D	홀길이 Flute Length L1	전장 Overall Length L	샹크 Shank Dia d	비고
2DUBE 010 050 S03	1	5	40	3		2DUBE 035 160 S04	3.5	16	55	4	
2DUBE 0105 050 S03	1.05	5	40	3		2DUBE 0355 160 S04	3.55	16	55	4	
2DUBE 011 060 S03	1.1	6	40	3		2DUBE 036 180 S04	3.6	18	55	4	
2DUBE 0115 060 S03	1.15	6	40	3		2DUBE 0365 180 S04	3.65	18	55	4	
2DUBE 012 060 S03	1.2	6	40	3		2DUBE 037 180 S04	3.7	18	55	4	
2DUBE 0125 060 S03	1.25	6	40	3		2DUBE 0375 180 S04	3.75	18	55	4	
2DUBE 013 060 S03	1.3	6	40	3		2DUBE 038 200 S04	3.8	20	55	4	
2DUBE 0135 070 S03	1.35	7	40	3		2DUBE 0385 200 S04	3.85	20	55	4	
2DUBE 014 070 S03	1.4	7	40	3		2DUBE 039 200 S04	3.9	20	55	4	
2DUBE 0145 070 S03	1.45	7	40	3		2DUBE 0395 200 S04	3.95	20	55	4	
2DUBE 015 070 S03	1.5	7	40	3		2DUBE 040 200 S04	4	20	55	4	
2DUBE 0155 080 S03	1.55	8	40	3		2DUBE 0405 200 S05	4.05	20	60	5	
2DUBE 016 080 S03	1.6	8	40	3		2DUBE 041 200 S05	4.1	20	60	5	
2DUBE 0165 080 S03	1.65	8	40	3		2DUBE 0415 200 S05	4.15	20	60	5	
2DUBE 017 080 S03	1.7	8	40	3		2DUBE 042 200 S05	4.2	20	60	5	
2DUBE 0175 090 S03	1.75	9	40	3		2DUBE 0425 200 S05	4.25	20	60	5	
2DUBE 018 090 S03	1.8	9	40	3		2DUBE 043 220 S05	4.3	22	60	5	
2DUBE 0185 090 S03	1.85	9	40	3		2DUBE 0435 220 S05	4.35	22	60	5	
2DUBE 019 090 S03	1.9	9	40	3		2DUBE 044 220 S05	4.4	22	60	5	
2DUBE 0195 100 S03	1.95	10	50	3		2DUBE 0445 220 S05	4.45	22	60	5	
2DUBE 020 100 S03	2	10	50	3		2DUBE 045 220 S05	4.5	22	60	5	
2DUBE 0205 100 S03	2.05	10	50	3		2DUBE 0455 220 S05	4.55	22	60	5	
2DUBE 021 100 S03	2.1	10	50	3		2DUBE 046 220 S05	4.6	22	60	5	
2DUBE 0215 110 S03	2.15	11	50	3		2DUBE 0465 220 S05	4.65	22	60	5	
2DUBE 022 110 S03	2.2	11	50	3		2DUBE 047 220 S05	4.7	22	60	5	
2DUBE 0225 110 S03	2.25	11	50	3		2DUBE 0475 220 S05	4.75	22	60	5	
2DUBE 023 110 S03	2.3	11	50	3		2DUBE 048 240 S05	4.8	24	60	5	
2DUBE 0235 110 S03	2.35	11	50	3		2DUBE 0485 240 S05	4.85	24	60	5	
2DUBE 024 120 S03	2.4	12	50	3		2DUBE 049 240 S05	4.9	24	60	5	
2DUBE 0245 120 S03	2.45	12	50	3		2DUBE 0495 240 S05	4.95	24	60	5	
2DUBE 025 120 S03	2.5	12	50	3		2DUBE 050 240 S05	5	24	60	5	
2DUBE 0255 120 S03	2.55	12	50	3		2DUBE 051 240 S06	5.1	24	60	6	
2DUBE 026 120 S03	2.6	12	50	3		2DUBE 052 240 S06	5.2	24	60	6	
2DUBE 0265 120 S03	2.65	12	50	3		2DUBE 053 240 S06	5.3	24	60	6	
2DUBE 027 140 S03	2.7	14	50	3		2DUBE 054 240 S06	5.4	24	60	6	
2DUBE 0275 140 S03	2.75	14	50	3		2DUBE 055 280 S06	5.5	28	65	6	
2DUBE 028 140 S03	2.8	14	50	3		2DUBE 056 280 S06	5.6	28	65	6	
2DUBE 0285 140 S03	2.85	14	50	3		2DUBE 057 280 S06	5.7	28	65	6	
2DUBE 029 140 S03	2.9	14	50	3		2DUBE 058 280 S06	5.8	28	65	6	
2DUBE 0295 140 S03	2.95	14	50	3		2DUBE 059 280 S06	5.9	28	65	6	
2DUBE 030 140 S03	3	14	50	3		2DUBE 060 280 S06	6	28	65	6	
2DUBE 0305 160 S04	3.05	16	55	4		2DUBE 061 280 S06	6.1	28	65	6	
2DUBE 031 160 S04	3.1	16	55	4		2DUBE 062 320 S07	6.2	32	65	7	
2DUBE 0315 160 S04	3.15	16	55	4		2DUBE 063 320 S07	6.3	32	65	7	
2DUBE 032 160 S04	3.2	16	55	4		2DUBE 064 320 S07	6.4	32	65	7	
2DUBE 0325 160 S04	3.25	16	55	4		2DUBE 065 320 S07	6.5	32	65	7	
2DUBE 033 160 S04	3.3	16	55	4		2DUBE 066 320 S07	6.6	32	65	7	
2DUBE 0335 160 S04	3.35	16	55	4		2DUBE 067 320 S07	6.7	32	65	7	
2DUBE 034 160 S04	3.4	16	55	4		2DUBE 068 320 S07	6.8	32	65	7	
2DUBE 0345 160 S04	3.45	16	55	4		2DUBE 069 320 S07	6.9	32	65	7	

단위 : mm

Order Number	날경 Diameter D	홈길이 Flute Length L1	전장 Overall Length L	샙크 Shank Dia d	비고	Order Number	날경 Diameter D	홈길이 Flute Length L1	전장 Overall Length L	샙크 Shank Dia d	비고
2DUBE 070 320 S07	7	32	65	7		2DUBE 120 520 S12	12	52	90	12	
2DUBE 071 320 S07	7.1	32	65	7							
2DUBE 072 360 S08	7.2	36	70	8							
2DUBE 073 360 S08	7.3	36	70	8							
2DUBE 074 360 S08	7.4	36	70	8							
2DUBE 075 360 S08	7.5	36	70	8							
2DUBE 076 360 S08	7.6	36	70	8							
2DUBE 077 360 S08	7.7	36	70	8							
2DUBE 078 360 S08	7.8	36	70	8							
2DUBE 079 360 S08	7.9	36	70	8							
2DUBE 080 360 S08	8	36	70	8							
2DUBE 081 360 S08	8.1	36	70	8							
2DUBE 082 400 S09	8.2	40	75	9							
2DUBE 083 400 S09	8.3	40	75	9							
2DUBE 084 400 S09	8.4	40	75	9							
2DUBE 085 400 S09	8.5	40	75	9							
2DUBE 086 400 S09	8.6	40	75	9							
2DUBE 087 400 S09	8.7	40	75	9							
2DUBE 088 400 S09	8.8	40	75	9							
2DUBE 089 400 S09	8.9	40	75	9							
2DUBE 090 400 S09	9	40	75	9							
2DUBE 091 400 S09	9.1	40	75	9							
2DUBE 092 430 S10	9.2	43	80	10							
2DUBE 093 430 S10	9.3	43	80	10							
2DUBE 094 430 S10	9.4	43	80	10							
2DUBE 095 430 S10	9.5	43	80	10							
2DUBE 096 430 S10	9.6	43	80	10							
2DUBE 097 430 S10	9.7	43	80	10							
2DUBE 098 430 S10	9.8	43	80	10							
2DUBE 099 430 S10	9.9	43	80	10							
2DUBE 100 430 S10	10	43	80	10							
2DUBE 101 430 S10	10.1	43	80	10							
2DUBE 102 450 S11	10.2	45	85	11							
2DUBE 103 450 S11	10.3	45	85	11							
2DUBE 104 450 S11	10.4	45	85	11							
2DUBE 105 450 S11	10.5	45	85	11							
2DUBE 106 450 S11	10.6	45	85	11							
2DUBE 107 450 S11	10.7	45	85	11							
2DUBE 108 450 S11	10.8	45	85	11							
2DUBE 109 450 S11	10.9	45	85	11							
2DUBE 110 450 S11	11	45	85	11							
2DUBE 111 450 S11	11.1	45	85	11							
2DUBE 112 520 S12	11.2	52	90	12							
2DUBE 113 520 S12	11.3	52	90	12							
2DUBE 114 520 S12	11.4	52	90	12							
2DUBE 115 520 S12	11.5	52	90	12							
2DUBE 116 520 S12	11.6	52	90	12							
2DUBE 117 520 S12	11.7	52	90	12							
2DUBE 118 520 S12	11.8	52	90	12							
2DUBE 119 520 S12	11.9	52	90	12							

## 초경 2날 두베 드릴

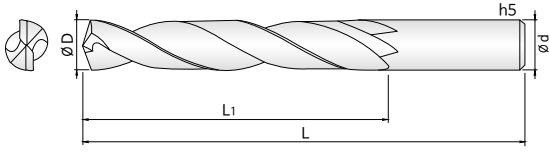

- HRC28이하, S45C, SCM, 주강, 주철용 고정밀 드릴
- T-CRO 코팅을 적용하여 드릴 가공 시 발생하는 윤착 현상을 최소화 하였습니다.
- 절삭 저항을 최소화하는 Point thinning을 채택 하였습니다.
- 특수 인선처리와 최적의 형상으로 치핑 및 돌발파손을 방지합니다.
- 우수한 공구의 강성과 칩 배출의 설계를 적용하여 칩 배출성을 향상시켰습니다.
- High-speed drills for materials up to HRC28, S45C, SCM, cast steels, and cast irons
- Minimized adhesion during drilling operations by applying T-CRO coating.
- Adopted point thinning to minimize cutting resistance.
- Prevents chipping and unexpected fractures with special edge treatment and optimal shape.
- Enhanced chip evacuation with the application of a design for superior tool rigidity and chip evacuation.

2  
미립자

WC  
미립자

TCRO  
COATING

h7  
Diameter  
Tolerance

30°  
Helix Angle

140°

CUTTING  
DATA

513P

단위 : mm

Order Number	날경 Diameter D	홀길이 Flute Length L1	전장 Overall Length L	샙크 Dia d	비고	Order Number	날경 Diameter D	홀길이 Flute Length L1	전장 Overall Length L	샙크 Dia d	비고
2DUBE 010 080 S03	1	8	40	3		2DUBE 060 360 S06	6	36	65	6	
2DUBE 011 090 S03	1.1	9	40	3		2DUBE 061 360 S06	6.1	36	65	6	
2DUBE 012 100 S03	1.2	10	40	3		2DUBE 062 420 S07	6.2	42	75	7	
2DUBE 013 100 S03	1.3	10	40	3		2DUBE 063 420 S07	6.3	42	75	7	
2DUBE 014 110 S03	1.4	11	40	3		2DUBE 064 420 S07	6.4	42	75	7	
2DUBE 015 110 S03	1.5	11	40	3		2DUBE 065 420 S07	6.5	42	75	7	
2DUBE 016 120 S03	1.6	12	40	3		2DUBE 066 420 S07	6.6	42	75	7	
2DUBE 017 120 S03	1.7	12	40	3		2DUBE 067 420 S07	6.7	42	75	7	
2DUBE 018 130 S03	1.8	13	40	3		2DUBE 068 420 S07	6.8	42	75	7	
2DUBE 019 130 S03	1.9	13	40	3		2DUBE 069 420 S07	6.9	42	75	7	
2DUBE 020 170 S03	2	17	50	3		2DUBE 070 420 S07	7	42	75	7	
2DUBE 021 170 S03	2.1	17	50	3		2DUBE 071 420 S07	7.1	42	75	7	
2DUBE 022 170 S03	2.2	17	50	3		2DUBE 072 460 S08	7.2	46	80	8	
2DUBE 023 170 S03	2.3	17	50	3		2DUBE 073 460 S08	7.3	46	80	8	
2DUBE 024 170 S03	2.4	17	50	3		2DUBE 074 460 S08	7.4	46	80	8	
2DUBE 025 170 S03	2.5	17	50	3		2DUBE 075 460 S08	7.5	46	80	8	
2DUBE 026 170 S03	2.6	17	50	3		2DUBE 076 460 S08	7.6	46	80	8	
2DUBE 027 170 S03	2.7	17	50	3		2DUBE 077 460 S08	7.7	46	80	8	
2DUBE 028 170 S03	2.8	17	50	3		2DUBE 078 460 S08	7.8	46	80	8	
2DUBE 029 170 S03	2.9	17	50	3		2DUBE 079 460 S08	7.9	46	80	8	
2DUBE 030 200 S04	3	20	55	4		2DUBE 080 460 S08	8	46	80	8	
2DUBE 031 200 S04	3.1	20	55	4		2DUBE 081 460 S08	8.1	46	80	8	
2DUBE 032 200 S04	3.2	20	55	4		2DUBE 082 500 S09	8.2	50	85	9	
2DUBE 033 200 S04	3.3	20	55	4		2DUBE 083 500 S09	8.3	50	85	9	
2DUBE 034 200 S04	3.4	20	55	4		2DUBE 084 500 S09	8.4	50	85	9	
2DUBE 035 200 S04	3.5	20	55	4		2DUBE 085 500 S09	8.5	50	85	9	
2DUBE 036 250 S04	3.6	25	55	4		2DUBE 086 500 S09	8.6	50	85	9	
2DUBE 037 250 S04	3.7	25	55	4		2DUBE 087 500 S09	8.7	50	85	9	
2DUBE 038 250 S04	3.8	25	55	4		2DUBE 088 500 S09	8.8	50	85	9	
2DUBE 039 250 S04	3.9	25	55	4		2DUBE 089 500 S09	8.9	50	85	9	
2DUBE 040 250 S04	4	25	55	4		2DUBE 090 500 S09	9	50	85	9	
2DUBE 041 250 S04	4.1	25	55	4		2DUBE 091 500 S09	9.1	50	85	9	
2DUBE 042 320 S05	4.2	32	60	5		2DUBE 092 530 S10	9.2	53	90	10	
2DUBE 043 320 S05	4.3	32	60	5		2DUBE 093 530 S10	9.3	53	90	10	
2DUBE 044 320 S05	4.4	32	60	5		2DUBE 094 530 S10	9.4	53	90	10	
2DUBE 045 320 S05	4.5	32	60	5		2DUBE 095 530 S10	9.5	53	90	10	
2DUBE 046 320 S05	4.6	32	60	5		2DUBE 096 530 S10	9.6	53	90	10	
2DUBE 047 320 S05	4.7	32	60	5		2DUBE 097 530 S10	9.7	53	90	10	
2DUBE 048 320 S05	4.8	32	60	5		2DUBE 098 530 S10	9.8	53	90	10	
2DUBE 049 320 S05	4.9	32	60	5		2DUBE 099 530 S10	9.9	53	90	10	
2DUBE 050 320 S05	5	32	60	5		2DUBE 100 530 S10	10	53	90	10	
2DUBE 051 320 S05	5.1	32	60	5		2DUBE 101 530 S10	10.1	53	90	10	
2DUBE 052 360 S06	5.2	36	65	6		2DUBE 102 550 S11	10.2	55	95	11	
2DUBE 053 360 S06	5.3	36	65	6		2DUBE 103 550 S11	10.3	55	95	11	
2DUBE 054 360 S06	5.4	36	65	6		2DUBE 104 550 S11	10.4	55	95	11	
2DUBE 055 360 S06	5.5	36	65	6		2DUBE 105 550 S11	10.5	55	95	11	
2DUBE 056 360 S06	5.6	36	65	6		2DUBE 106 550 S11	10.6	55	95	11	
2DUBE 057 360 S06	5.7	36	65	6		2DUBE 107 550 S11	10.7	55	95	11	
2DUBE 058 360 S06	5.8	36	65	6		2DUBE 108 550 S11	10.8	55	95	11	
2DUBE 059 360 S06	5.9	36	65	6		2DUBE 109 550 S11	10.9	55	95	11	

단위 : mm

Order Number	날경 Diameter D	홈길이 Flute Length L1	전장 Overall Length L	샙크 Dia d	비고	Order Number	날경 Diameter D	홈길이 Flute Length L1	전장 Overall Length L	샙크 Dia d	비고
2DUBE 110 550 S11	11	55	100	11		2DUBE 160 690 S16	16	69	115	16	
2DUBE 111 550 S11	11.1	55	100	11		2DUBE 161 690 S16	16.1	69	115	16	
2DUBE 112 620 S12	11.2	62	100	12		2DUBE 162 710 S17	16.2	71	120	17	
2DUBE 113 620 S12	11.3	62	100	12		2DUBE 163 710 S17	16.3	71	120	17	
2DUBE 114 620 S12	11.4	62	100	12		2DUBE 164 710 S17	16.4	71	120	17	
2DUBE 115 620 S12	11.5	62	100	12		2DUBE 165 710 S17	16.5	71	120	17	
2DUBE 116 620 S12	11.6	62	100	12		2DUBE 166 710 S17	16.6	71	120	17	
2DUBE 117 620 S12	11.7	62	100	12		2DUBE 167 710 S17	16.7	71	120	17	
2DUBE 118 620 S12	11.8	62	100	12		2DUBE 168 710 S17	16.8	71	120	17	
2DUBE 119 620 S12	11.9	62	100	12		2DUBE 169 710 S17	16.9	71	120	17	
2DUBE 120 620 S12	12	62	100	12		2DUBE 170 710 S17	17	71	120	17	
2DUBE 121 620 S12	12.1	62	100	12		2DUBE 171 710 S17	17.1	71	120	17	
2DUBE 122 620 S13	12.2	62	100	13		2DUBE 172 740 S18	17.2	74	125	18	
2DUBE 123 620 S13	12.3	62	100	13		2DUBE 173 740 S18	17.3	74	125	18	
2DUBE 124 620 S13	12.4	62	100	13		2DUBE 174 740 S18	17.4	74	125	18	
2DUBE 125 620 S13	12.5	62	100	13		2DUBE 175 740 S18	17.5	74	125	18	
2DUBE 126 620 S13	12.6	62	100	13		2DUBE 176 740 S18	17.6	74	125	18	
2DUBE 127 620 S13	12.7	62	100	13		2DUBE 177 740 S18	17.7	74	125	18	
2DUBE 128 620 S13	12.8	62	100	13		2DUBE 178 740 S18	17.8	74	125	18	
2DUBE 129 620 S13	12.9	62	100	13		2DUBE 179 740 S18	17.9	74	125	18	
2DUBE 130 620 S13	13	62	100	13		2DUBE 180 740 S18	18	74	125	18	
2DUBE 131 620 S13	13.1	62	100	13		2DUBE 181 740 S18	18.1	74	125	18	
2DUBE 132 640 S14	13.2	64	105	14		2DUBE 182 760 S19	18.2	76	130	19	
2DUBE 133 640 S14	13.3	64	105	14		2DUBE 183 760 S19	18.3	76	130	19	
2DUBE 134 640 S14	13.4	64	105	14		2DUBE 184 760 S19	18.4	76	130	19	
2DUBE 135 640 S14	13.5	64	105	14		2DUBE 185 760 S19	18.5	76	130	19	
2DUBE 136 640 S14	13.6	64	105	14		2DUBE 186 760 S19	18.6	76	130	19	
2DUBE 137 640 S14	13.7	64	105	14		2DUBE 187 760 S19	18.7	76	130	19	
2DUBE 138 640 S14	13.8	64	105	14		2DUBE 188 760 S19	18.8	76	130	19	
2DUBE 139 640 S14	13.9	64	105	14		2DUBE 189 760 S19	18.9	76	130	19	
2DUBE 140 640 S14	14	64	105	14		2DUBE 190 760 S19	19	76	130	19	
2DUBE 141 640 S14	14.1	64	105	14		2DUBE 191 760 S19	19.1	76	130	19	
2DUBE 142 670 S15	14.2	67	110	15		2DUBE 192 800 S20	19.2	80	130	20	
2DUBE 143 670 S15	14.3	67	110	15		2DUBE 193 800 S20	19.3	80	130	20	
2DUBE 144 670 S15	14.4	67	110	15		2DUBE 194 800 S20	19.4	80	130	20	
2DUBE 145 670 S15	14.5	67	110	15		2DUBE 195 800 S20	19.5	80	130	20	
2DUBE 146 670 S15	14.6	67	110	15		2DUBE 196 800 S20	19.6	80	130	20	
2DUBE 147 670 S15	14.7	67	110	15		2DUBE 197 800 S20	19.7	80	130	20	
2DUBE 148 670 S15	14.8	67	110	15		2DUBE 198 800 S20	19.8	80	130	20	
2DUBE 149 670 S15	14.9	67	110	15		2DUBE 199 800 S20	19.9	80	130	20	
2DUBE 150 670 S15	15	67	110	15		2DUBE 200 800 S20	20	80	130	20	
2DUBE 151 670 S15	15.1	67	110	15							
2DUBE 152 690 S16	15.2	69	115	16							
2DUBE 153 690 S16	15.3	69	115	16							
2DUBE 154 690 S16	15.4	69	115	16							
2DUBE 155 690 S16	15.5	69	115	16							
2DUBE 156 690 S16	15.6	69	115	16							
2DUBE 157 690 S16	15.7	69	115	16							
2DUBE 158 690 S16	15.8	69	115	16							
2DUBE 159 690 S16	15.9	69	115	16							

## 초경 4날 두베 드릴

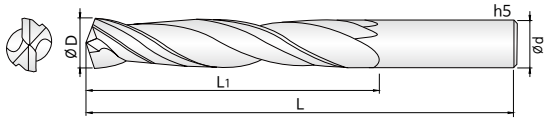

End point (2F)  
Flute (4F)

- HRc28이하, S45C, SCM, 주강, 주철용 고정밀 드릴
- T-CRO 코팅을 적용하여 드릴 가공 시 발생하는 윤착 현상을 최소화 하였습니다.
- 절삭 저항을 최소화하는 Point thinning을 채택 하였습니다.
- 특수 인선처리와 최적의 형상으로 치핑 및 돌발파손을 방지합니다.
- 우수한 공구의 강성과 칩 배출의 설계를 적용하여 칩 배출성을 향상시켰습니다.
- High-speed drills for materials up to HRc28, S45C, SCM, cast steels, and cast irons
- Minimized adhesion during drilling operations by applying T-CRO coating.
- Adopted point thinning to minimize cutting resistance.
- Prevents chipping and unexpected fractures with special edge treatment and optimal shape.
- Enhanced chip evacuation with the application of a design for superior tool rigidity and chip evacuation.

4  
미립자

WC  
미립자

TCRO  
COATING

h7  
Diameter  
Tolerance

30°  
Helix Angle

140°

CUTTING  
DATA

511P

단위 : mm

Order Number	날경 Diameter D	홈길이 Flute Length L1	전장 Overall Length L	생크 Dia d	비고	Order Number	날경 Diameter D	홈길이 Flute Length L1	전장 Overall Length L	생크 Dia d	비고
4DUBE 060 360 S06	6	36	65	6							
4DUBE 080 460 S08	8	46	80	8							
4DUBE 100 530 S10	10	53	90	10							
4DUBE 120 620 S12	12	62	100	12							



## 초경 2날 두배 V 드릴 [3XD]

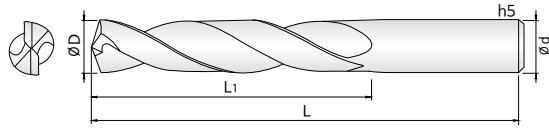

- HRc28이하, S45C, SCM, 주강, 주철용 고정밀 드릴
- T-CRO 코팅을 적용하여 드릴 가공 시 발생하는 윤착 현상을 최소화 하였습니다.
- 절삭 저항을 최소화하는 Point thinning을 채택 하였습니다.
- 특수 인선처리와 최적의 형상으로 치핑 및 돌발파손을 방지합니다.
- 우수한 공구의 강성과 칩 배출의 설계를 적용하여 칩 배출성을 향상시켰습니다.

### High-speed drills for materials up to HRc28, S45C, SCM, cast steels, and cast irons

- Minimized adhesion during drilling operations by applying T-CRO coating.
- Adopted point thinning to minimize cutting resistance.
- Prevents chipping and unexpected fractures with special edge treatment and optimal shape.
- Enhanced chip evacuation with the application of a design for superior tool rigidity and chip evacuation.



514P

단위 : mm

Order Number	날경 Diameter D	홀길이 Flute Length L1	전장 Overall Length L	샹크 Shank Dia d	비고	Order Number	날경 Diameter D	홀길이 Flute Length L1	전장 Overall Length L	샹크 Shank Dia d	비고
2DUBEV 010 080 S03	1	8	40	3		2DUBEV 060 280 S06	6	28	65	6	
2DUBEV 011 080 S03	1.1	8	40	3		2DUBEV 061 340 S08	6.1	34	80	8	
2DUBEV 012 080 S03	1.2	8	40	3		2DUBEV 062 340 S08	6.2	34	80	8	
2DUBEV 013 080 S03	1.3	8	40	3		2DUBEV 063 340 S08	6.3	34	80	8	
2DUBEV 014 080 S03	1.4	8	40	3		2DUBEV 064 340 S08	6.4	34	80	8	
2DUBEV 015 080 S03	1.5	8	50	3		2DUBEV 065 340 S08	6.5	34	80	8	
2DUBEV 016 080 S03	1.6	8	50	3		2DUBEV 066 340 S08	6.6	34	80	8	
2DUBEV 017 100 S03	1.7	10	50	3		2DUBEV 067 340 S08	6.7	34	80	8	
2DUBEV 018 100 S03	1.8	10	50	3		2DUBEV 068 340 S08	6.8	34	80	8	
2DUBEV 019 100 S03	1.9	10	50	3		2DUBEV 069 340 S08	6.9	34	80	8	
2DUBEV 020 160 S04	2	16	50	4		2DUBEV 070 340 S08	7	34	80	8	
2DUBEV 021 160 S04	2.1	16	50	4		2DUBEV 071 410 S08	7.1	41	80	8	
2DUBEV 022 160 S04	2.2	16	50	4		2DUBEV 072 410 S08	7.2	41	80	8	
2DUBEV 023 160 S04	2.3	16	50	4		2DUBEV 073 410 S08	7.3	41	80	8	
2DUBEV 024 160 S04	2.4	16	50	4		2DUBEV 074 410 S08	7.4	41	80	8	
2DUBEV 025 200 S04	2.5	20	50	4		2DUBEV 075 410 S08	7.5	41	80	8	
2DUBEV 026 200 S04	2.6	20	50	4		2DUBEV 076 410 S08	7.6	41	80	8	
2DUBEV 027 200 S04	2.7	20	50	4		2DUBEV 077 410 S08	7.7	41	80	8	
2DUBEV 028 200 S04	2.8	20	50	4		2DUBEV 078 410 S08	7.8	41	80	8	
2DUBEV 029 200 S04	2.9	20	50	4		2DUBEV 079 410 S08	7.9	41	80	8	
2DUBEV 030 200 S06	3	20	60	6		2DUBEV 080 410 S08	8	41	80	8	
2DUBEV 031 200 S06	3.1	20	60	6		2DUBEV 081 470 S10	8.1	47	90	10	
2DUBEV 032 200 S06	3.2	20	60	6		2DUBEV 082 470 S10	8.2	47	90	10	
2DUBEV 033 200 S06	3.3	20	60	6		2DUBEV 083 470 S10	8.3	47	90	10	
2DUBEV 034 200 S06	3.4	20	60	6		2DUBEV 084 470 S10	8.4	47	90	10	
2DUBEV 035 200 S06	3.5	20	60	6		2DUBEV 085 470 S10	8.5	47	90	10	
2DUBEV 036 200 S06	3.6	20	60	6		2DUBEV 086 470 S10	8.6	47	90	10	
2DUBEV 037 200 S06	3.7	20	60	6		2DUBEV 087 470 S10	8.7	47	90	10	
2DUBEV 038 240 S06	3.8	24	65	6		2DUBEV 088 470 S10	8.8	47	90	10	
2DUBEV 039 240 S06	3.9	24	65	6		2DUBEV 089 470 S10	8.9	47	90	10	
2DUBEV 040 240 S06	4	24	65	6		2DUBEV 090 470 S10	9	47	90	10	
2DUBEV 041 240 S06	4.1	24	65	6		2DUBEV 091 470 S10	9.1	47	90	10	
2DUBEV 042 240 S06	4.2	24	65	6		2DUBEV 092 470 S10	9.2	47	90	10	
2DUBEV 043 240 S06	4.3	24	65	6		2DUBEV 093 470 S10	9.3	47	90	10	
2DUBEV 044 240 S06	4.4	24	65	6		2DUBEV 094 470 S10	9.4	47	90	10	
2DUBEV 045 240 S06	4.5	24	65	6		2DUBEV 095 470 S10	9.5	47	90	10	
2DUBEV 046 240 S06	4.6	24	65	6		2DUBEV 096 470 S10	9.6	47	90	10	
2DUBEV 047 240 S06	4.7	24	65	6		2DUBEV 097 470 S10	9.7	47	90	10	
2DUBEV 048 280 S06	4.8	28	65	6		2DUBEV 098 470 S10	9.8	47	90	10	
2DUBEV 049 280 S06	4.9	28	65	6		2DUBEV 099 470 S10	9.9	47	90	10	
2DUBEV 050 280 S06	5	28	65	6		2DUBEV 100 470 S10	10	47	90	10	
2DUBEV 051 280 S06	5.1	28	65	6		2DUBEV 101 550 S12	10.1	55	100	12	
2DUBEV 052 280 S06	5.2	28	65	6		2DUBEV 102 550 S12	10.2	55	100	12	
2DUBEV 053 280 S06	5.3	28	65	6		2DUBEV 103 550 S12	10.3	55	100	12	
2DUBEV 054 280 S06	5.4	28	65	6		2DUBEV 104 550 S12	10.4	55	100	12	
2DUBEV 055 280 S06	5.5	28	65	6		2DUBEV 105 550 S12	10.5	55	100	12	
2DUBEV 056 280 S06	5.6	28	65	6		2DUBEV 106 550 S12	10.6	55	100	12	
2DUBEV 057 280 S06	5.7	28	65	6		2DUBEV 107 550 S12	10.7	55	100	12	
2DUBEV 058 280 S06	5.8	28	65	6		2DUBEV 108 550 S12	10.8	55	100	12	
2DUBEV 059 280 S06	5.9	28	65	6		2DUBEV 109 550 S12	10.9	55	100	12	

단위 : mm

Order Number	날경 Diameter D	홈길이 Flute Length L1	전장 Overall Length L	샙크 Dia d	비고	Order Number	날경 Diameter D	홈길이 Flute Length L1	전장 Overall Length L	샙크 Dia d	비고
2DUBEV 110 550 S12	11	55	100	12		2DUBEV 160 650 S16	16	65	115	16	
2DUBEV 111 550 S12	11.1	55	100	12		2DUBEV 161 730 S18	16.1	73	125	18	
2DUBEV 112 550 S12	11.2	55	100	12		2DUBEV 162 730 S18	16.2	73	125	18	
2DUBEV 113 550 S12	11.3	55	100	12		2DUBEV 163 730 S18	16.3	73	125	18	
2DUBEV 114 550 S12	11.4	55	100	12		2DUBEV 164 730 S18	16.4	73	125	18	
2DUBEV 115 550 S12	11.5	55	100	12		2DUBEV 165 730 S18	16.5	73	125	18	
2DUBEV 116 550 S12	11.6	55	100	12		2DUBEV 166 730 S18	16.6	73	125	18	
2DUBEV 117 550 S12	11.7	55	100	12		2DUBEV 167 730 S18	16.7	73	125	18	
2DUBEV 118 550 S12	11.8	55	100	12		2DUBEV 168 730 S18	16.8	73	125	18	
2DUBEV 119 550 S12	11.9	55	100	12		2DUBEV 169 730 S18	16.9	73	125	18	
2DUBEV 120 550 S12	12	55	100	12		2DUBEV 170 730 S18	17	73	125	18	
2DUBEV 121 600 S14	12.1	60	100	14		2DUBEV 171 730 S18	17.1	73	125	18	
2DUBEV 122 600 S14	12.2	60	100	14		2DUBEV 172 730 S18	17.2	73	125	18	
2DUBEV 123 600 S14	12.3	60	100	14		2DUBEV 173 730 S18	17.3	73	125	18	
2DUBEV 124 600 S14	12.4	60	100	14		2DUBEV 174 730 S18	17.4	73	125	18	
2DUBEV 125 600 S14	12.5	60	100	14		2DUBEV 175 730 S18	17.5	73	125	18	
2DUBEV 126 600 S14	12.6	60	100	14		2DUBEV 176 730 S18	17.6	73	125	18	
2DUBEV 127 600 S14	12.7	60	100	14		2DUBEV 177 730 S18	17.7	73	125	18	
2DUBEV 128 600 S14	12.8	60	100	14		2DUBEV 178 730 S18	17.8	73	125	18	
2DUBEV 129 600 S14	12.9	60	100	14		2DUBEV 179 730 S18	17.9	73	125	18	
2DUBEV 130 600 S14	13	60	100	14		2DUBEV 180 730 S18	18	73	125	18	
2DUBEV 131 600 S14	13.1	60	100	14		2DUBEV 181 790 S20	18.1	79	130	20	
2DUBEV 132 600 S14	13.2	60	105	14		2DUBEV 182 790 S20	18.2	79	130	20	
2DUBEV 133 600 S14	13.3	60	105	14		2DUBEV 183 790 S20	18.3	79	130	20	
2DUBEV 134 600 S14	13.4	60	105	14		2DUBEV 184 790 S20	18.4	79	130	20	
2DUBEV 135 600 S14	13.5	60	105	14		2DUBEV 185 790 S20	18.5	79	130	20	
2DUBEV 136 600 S14	13.6	60	105	14		2DUBEV 186 790 S20	18.6	79	130	20	
2DUBEV 137 600 S14	13.7	60	105	14		2DUBEV 187 790 S20	18.7	79	130	20	
2DUBEV 138 600 S14	13.8	60	105	14		2DUBEV 188 790 S20	18.8	79	130	20	
2DUBEV 139 600 S14	13.9	60	105	14		2DUBEV 189 790 S20	18.9	79	130	20	
2DUBEV 140 600 S14	14	60	105	14		2DUBEV 190 790 S20	19	79	130	20	
2DUBEV 141 650 S16	14.1	65	110	16		2DUBEV 191 790 S20	19.1	79	130	20	
2DUBEV 142 650 S16	14.2	65	110	16		2DUBEV 192 790 S20	19.2	79	130	20	
2DUBEV 143 650 S16	14.3	65	110	16		2DUBEV 193 790 S20	19.3	79	130	20	
2DUBEV 144 650 S16	14.4	65	110	16		2DUBEV 194 790 S20	19.4	79	130	20	
2DUBEV 145 650 S16	14.5	65	110	16		2DUBEV 195 790 S20	19.5	79	130	20	
2DUBEV 146 650 S16	14.6	65	110	16		2DUBEV 196 790 S20	19.6	79	130	20	
2DUBEV 147 650 S16	14.7	65	110	16		2DUBEV 197 790 S20	19.7	79	130	20	
2DUBEV 148 650 S16	14.8	65	110	16		2DUBEV 198 790 S20	19.8	79	130	20	
2DUBEV 149 650 S16	14.9	65	110	16		2DUBEV 199 790 S20	19.9	79	130	20	
2DUBEV 150 650 S16	15	65	110	16		2DUBEV 200 790 S20	20	79	130	20	
2DUBEV 151 650 S16	15.1	65	110	16							
2DUBEV 152 650 S16	15.2	65	115	16							
2DUBEV 153 650 S16	15.3	65	115	16							
2DUBEV 154 650 S16	15.4	65	115	16							
2DUBEV 155 650 S16	15.5	65	115	16							
2DUBEV 156 650 S16	15.6	65	115	16							
2DUBEV 157 650 S16	15.7	65	115	16							
2DUBEV 158 650 S16	15.8	65	115	16							
2DUBEV 159 650 S16	15.9	65	115	16							

## 초경 2날 두배 V 드릴 [5XD]

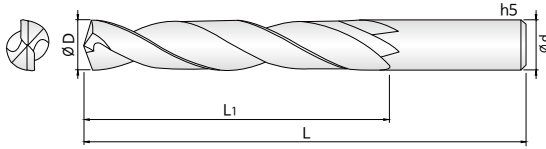

- HRc28이하, S45C, SCM, 주강, 주철용 고정밀 드릴
- T-CRO 코팅을 적용하여 드릴 가공 시 발생하는 용착 현상을 최소화 하였습니다.
- 절삭 저항을 최소화하는 Point thinning을 채택 하였습니다.
- 특수 인선처리와 최적의 형상으로 치핑 및 돌발파손을 방지합니다.
- 우수한 공구의 강성과 칩 배출의 설계를 적용하여 칩 배출성을 향상시켰습니다.

- High-speed drills for materials up to HRc28, S45C, SCM, cast steels, and cast irons
- Minimized adhesion during drilling operations by applying T-CRO coating.
- Adopted point thinning to minimize cutting resistance.
- Prevents chipping and unexpected fractures with special edge treatment and optimal shape.
- Enhanced chip evacuation with the application of a design for superior tool rigidity and chip evacuation.



514P

단위 : mm

Order Number	날경 Diameter D	홀길이 Flute Length L1	전장 Overall Length L	샙크 Shank Dia d	비고	Order Number	날경 Diameter D	홀길이 Flute Length L1	전장 Overall Length L	샙크 Shank Dia d	비고
2DUBEV 010 100 S03	1	10	55	3		2DUBEV 060 440 S06	6	44	80	6	
2DUBEV 011 120 S03	1.1	12	55	3		2DUBEV 061 530 S08	6.1	53	90	8	
2DUBEV 012 120 S03	1.2	12	55	3		2DUBEV 062 530 S08	6.2	53	90	8	
2DUBEV 013 120 S03	1.3	12	55	3		2DUBEV 063 530 S08	6.3	53	90	8	
2DUBEV 014 120 S03	1.4	12	55	3		2DUBEV 064 530 S08	6.4	53	90	8	
2DUBEV 015 120 S03	1.5	12	55	3		2DUBEV 065 530 S08	6.5	53	90	8	
2DUBEV 016 160 S03	1.6	16	55	3		2DUBEV 066 530 S08	6.6	53	90	8	
2DUBEV 017 160 S03	1.7	16	55	3		2DUBEV 067 530 S08	6.7	53	90	8	
2DUBEV 018 160 S03	1.8	16	55	3		2DUBEV 068 530 S08	6.8	53	90	8	
2DUBEV 019 160 S03	1.9	16	55	3		2DUBEV 069 530 S08	6.9	53	90	8	
2DUBEV 020 210 S04	2	21	55	4		2DUBEV 070 530 S08	7	53	90	8	
2DUBEV 021 210 S04	2.1	21	55	4		2DUBEV 071 530 S08	7.1	53	90	8	
2DUBEV 022 210 S04	2.2	21	55	4		2DUBEV 072 530 S08	7.2	53	90	8	
2DUBEV 023 210 S04	2.3	21	55	4		2DUBEV 073 530 S08	7.3	53	90	8	
2DUBEV 024 210 S04	2.4	21	55	4		2DUBEV 074 530 S08	7.4	53	90	8	
2DUBEV 025 210 S04	2.5	21	55	4		2DUBEV 075 530 S08	7.5	53	90	8	
2DUBEV 026 210 S04	2.6	21	55	4		2DUBEV 076 530 S08	7.6	53	90	8	
2DUBEV 027 210 S04	2.7	21	55	4		2DUBEV 077 530 S08	7.7	53	90	8	
2DUBEV 028 210 S04	2.8	21	55	4		2DUBEV 078 530 S08	7.8	53	90	8	
2DUBEV 029 210 S04	2.9	21	55	4		2DUBEV 079 530 S08	7.9	53	90	8	
2DUBEV 030 280 S06	3	28	65	6		2DUBEV 080 530 S08	8	53	90	8	
2DUBEV 031 280 S06	3.1	28	65	6		2DUBEV 081 610 S10	8.1	61	105	10	
2DUBEV 032 280 S06	3.2	28	65	6		2DUBEV 082 610 S10	8.2	61	105	10	
2DUBEV 033 280 S06	3.3	28	65	6		2DUBEV 083 610 S10	8.3	61	105	10	
2DUBEV 034 280 S06	3.4	28	65	6		2DUBEV 084 610 S10	8.4	61	105	10	
2DUBEV 035 280 S06	3.5	28	65	6		2DUBEV 085 610 S10	8.5	61	105	10	
2DUBEV 036 280 S06	3.6	28	65	6		2DUBEV 086 610 S10	8.6	61	105	10	
2DUBEV 037 280 S06	3.7	28	65	6		2DUBEV 087 610 S10	8.7	61	105	10	
2DUBEV 038 360 S06	3.8	36	75	6		2DUBEV 088 610 S10	8.8	61	105	10	
2DUBEV 039 360 S06	3.9	36	75	6		2DUBEV 089 610 S10	8.9	61	105	10	
2DUBEV 040 360 S06	4	36	75	6		2DUBEV 090 610 S10	9	61	105	10	
2DUBEV 041 360 S06	4.1	36	75	6		2DUBEV 091 610 S10	9.1	61	105	10	
2DUBEV 042 360 S06	4.2	36	75	6		2DUBEV 092 610 S10	9.2	61	105	10	
2DUBEV 043 360 S06	4.3	36	75	6		2DUBEV 093 610 S10	9.3	61	105	10	
2DUBEV 044 360 S06	4.4	36	75	6		2DUBEV 094 610 S10	9.4	61	105	10	
2DUBEV 045 360 S06	4.5	36	75	6		2DUBEV 095 610 S10	9.5	61	105	10	
2DUBEV 046 360 S06	4.6	36	75	6		2DUBEV 096 610 S10	9.6	61	105	10	
2DUBEV 047 360 S06	4.7	36	75	6		2DUBEV 097 610 S10	9.7	61	105	10	
2DUBEV 048 440 S06	4.8	44	80	6		2DUBEV 098 610 S10	9.8	61	105	10	
2DUBEV 049 440 S06	4.9	44	80	6		2DUBEV 099 610 S10	9.9	61	105	10	
2DUBEV 050 440 S06	5	44	80	6		2DUBEV 100 610 S10	10	61	105	10	
2DUBEV 051 440 S06	5.1	44	80	6		2DUBEV 101 710 S12	10.1	71	120	12	
2DUBEV 052 440 S06	5.2	44	80	6		2DUBEV 102 710 S12	10.2	71	120	12	
2DUBEV 053 440 S06	5.3	44	80	6		2DUBEV 103 710 S12	10.3	71	120	12	
2DUBEV 054 440 S06	5.4	44	80	6		2DUBEV 104 710 S12	10.4	71	120	12	
2DUBEV 055 440 S06	5.5	44	80	6		2DUBEV 105 710 S12	10.5	71	120	12	
2DUBEV 056 440 S06	5.6	44	80	6		2DUBEV 106 710 S12	10.6	71	120	12	
2DUBEV 057 440 S06	5.7	44	80	6		2DUBEV 107 710 S12	10.7	71	120	12	
2DUBEV 058 440 S06	5.8	44	80	6		2DUBEV 108 710 S12	10.8	71	120	12	
2DUBEV 059 440 S06	5.9	44	80	6		2DUBEV 109 710 S12	10.9	71	120	12	

단위 : mm

Order Number	날경 Diameter D	홈길이 Flute Length L1	전장 Overall Length L	샙크 Dia d	비고	Order Number	날경 Diameter D	홈길이 Flute Length L1	전장 Overall Length L	샙크 Dia d	비고
2DUBEV 110 710 S12	11	71	120	12		2DUBEV 160 830 S16	16	83	135	16	
2DUBEV 111 710 S12	11.1	71	120	12		2DUBEV 161 930 S18	16.1	93	145	18	
2DUBEV 112 710 S12	11.2	71	120	12		2DUBEV 162 930 S18	16.2	93	145	18	
2DUBEV 113 710 S12	11.3	71	120	12		2DUBEV 163 930 S18	16.3	93	145	18	
2DUBEV 114 710 S12	11.4	71	120	12		2DUBEV 164 930 S18	16.4	93	145	18	
2DUBEV 115 710 S12	11.5	71	120	12		2DUBEV 165 930 S18	16.5	93	145	18	
2DUBEV 116 710 S12	11.6	71	120	12		2DUBEV 166 930 S18	16.6	93	145	18	
2DUBEV 117 710 S12	11.7	71	120	12		2DUBEV 167 930 S18	16.7	93	145	18	
2DUBEV 118 710 S12	11.8	71	120	12		2DUBEV 168 930 S18	16.8	93	145	18	
2DUBEV 119 710 S12	11.9	71	120	12		2DUBEV 169 930 S18	16.9	93	145	18	
2DUBEV 120 710 S12	12	71	120	12		2DUBEV 170 930 S18	17	93	145	18	
2DUBEV 121 770 S14	12.1	77	125	14		2DUBEV 171 930 S18	17.1	93	145	18	
2DUBEV 122 770 S14	12.2	77	125	14		2DUBEV 172 930 S18	17.2	93	145	18	
2DUBEV 123 770 S14	12.3	77	125	14		2DUBEV 173 930 S18	17.3	93	145	18	
2DUBEV 124 770 S14	12.4	77	125	14		2DUBEV 174 930 S18	17.4	93	145	18	
2DUBEV 125 770 S14	12.5	77	125	14		2DUBEV 175 930 S18	17.5	93	145	18	
2DUBEV 126 770 S14	12.6	77	125	14		2DUBEV 176 930 S18	17.6	93	145	18	
2DUBEV 127 770 S14	12.7	77	125	14		2DUBEV 177 930 S18	17.7	93	145	18	
2DUBEV 128 770 S14	12.8	77	125	14		2DUBEV 178 930 S18	17.8	93	145	18	
2DUBEV 129 770 S14	12.9	77	125	14		2DUBEV 179 930 S18	17.9	93	145	18	
2DUBEV 130 770 S14	13	77	125	14		2DUBEV 180 930 S18	18	93	145	18	
2DUBEV 131 770 S14	13.1	77	125	14		2DUBEV 181 1010 S20	18.1	101	155	20	
2DUBEV 132 770 S14	13.2	77	125	14		2DUBEV 182 1010 S20	18.2	101	155	20	
2DUBEV 133 770 S14	13.3	77	125	14		2DUBEV 183 1010 S20	18.3	101	155	20	
2DUBEV 134 770 S14	13.4	77	125	14		2DUBEV 184 1010 S20	18.4	101	155	20	
2DUBEV 135 770 S14	13.5	77	125	14		2DUBEV 185 1010 S20	18.5	101	155	20	
2DUBEV 136 770 S14	13.6	77	125	14		2DUBEV 186 1010 S20	18.6	101	155	20	
2DUBEV 137 770 S14	13.7	77	125	14		2DUBEV 187 1010 S20	18.7	101	155	20	
2DUBEV 138 770 S14	13.8	77	125	14		2DUBEV 188 1010 S20	18.8	101	155	20	
2DUBEV 139 770 S14	13.9	77	125	14		2DUBEV 189 1010 S20	18.9	101	155	20	
2DUBEV 140 770 S14	14	77	125	14		2DUBEV 190 1010 S20	19	101	155	20	
2DUBEV 141 830 S16	14.1	83	135	16		2DUBEV 191 1010 S20	19.1	101	155	20	
2DUBEV 142 830 S16	14.2	83	135	16		2DUBEV 192 1010 S20	19.2	101	155	20	
2DUBEV 143 830 S16	14.3	83	135	16		2DUBEV 193 1010 S20	19.3	101	155	20	
2DUBEV 144 830 S16	14.4	83	135	16		2DUBEV 194 1010 S20	19.4	101	155	20	
2DUBEV 145 830 S16	14.5	83	135	16		2DUBEV 195 1010 S20	19.5	101	155	20	
2DUBEV 146 830 S16	14.6	83	135	16		2DUBEV 196 1010 S20	19.6	101	155	20	
2DUBEV 147 830 S16	14.7	83	135	16		2DUBEV 197 1010 S20	19.7	101	155	20	
2DUBEV 148 830 S16	14.8	83	135	16		2DUBEV 198 1010 S20	19.8	101	155	20	
2DUBEV 149 830 S16	14.9	83	135	16		2DUBEV 199 1010 S20	19.9	101	155	20	
2DUBEV 150 830 S16	15	83	135	16		2DUBEV 200 1010 S20	20	101	155	20	
2DUBEV 151 830 S16	15.1	83	135	16							
2DUBEV 152 830 S16	15.2	83	135	16							
2DUBEV 153 830 S16	15.3	83	135	16							
2DUBEV 154 830 S16	15.4	83	135	16							
2DUBEV 155 830 S16	15.5	83	135	16							
2DUBEV 156 830 S16	15.6	83	135	16							
2DUBEV 157 830 S16	15.7	83	135	16							
2DUBEV 158 830 S16	15.8	83	135	16							
2DUBEV 159 830 S16	15.9	83	135	16							

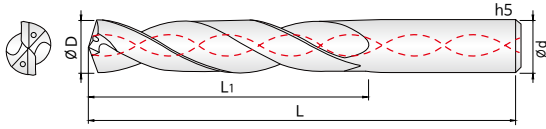

- SUS, Titanium, HRC28이하 SCM등의 합금용 난삭재 가공 드릴
- Cross cut 코팅을 적용하여 우수한 내열성과 내마모성으로 절삭영역을 확대하였습니다.
- 절삭 저항을 최소화하는 Point thinning을 채택 하였습니다.
- 최적에 플루트 형상 설계와 내부급유 방식을 적용하여 칩배출 성능이 매우 우수합니다.
- 140도 선단각 설계하여 높은 고정밀, 고속 드릴링 작업에 탁월한 성능을 발휘합니다.

**High-speed drills for SUS, alloy materials up to HRC28, SCM and Titanium**

- Minimized adhesion during drilling operations by applying cross-cut coating.
- Adopted point thinning to minimize cutting resistance.
- Excellent chip evacuation performance achieved by applying an optimal flute design and internal coolant system.
- Design with a 140-degree point angle for outstanding performance in high precision, high-speed drilling operations.



515P

단위 : mm

Order Number	날경 Diameter D	홈길이 Flute Length L1	전장 Overall Length L	샙크 Shank Dia d	비고	Order Number	날경 Diameter D	홈길이 Flute Length L1	전장 Overall Length L	샙크 Shank Dia d	비고
2DUBEW 010 080 S03	1	8	40	3		2DUBEW 060 280 S06	6	28	65	6	
2DUBEW 011 080 S03	1.1	8	40	3		2DUBEW 061 340 S08	6.1	34	80	8	
2DUBEW 012 080 S03	1.2	8	40	3		2DUBEW 062 340 S08	6.2	34	80	8	
2DUBEW 013 080 S03	1.3	8	40	3		2DUBEW 063 340 S08	6.3	34	80	8	
2DUBEW 014 080 S03	1.4	8	40	3		2DUBEW 064 340 S08	6.4	34	80	8	
2DUBEW 015 080 S03	1.5	8	50	3		2DUBEW 065 340 S08	6.5	34	80	8	
2DUBEW 016 080 S03	1.6	8	50	3		2DUBEW 066 340 S08	6.6	34	80	8	
2DUBEW 017 100 S03	1.7	10	50	3		2DUBEW 067 340 S08	6.7	34	80	8	
2DUBEW 018 100 S03	1.8	10	50	3		2DUBEW 068 340 S08	6.8	34	80	8	
2DUBEW 019 100 S03	1.9	10	50	3		2DUBEW 069 340 S08	6.9	34	80	8	
2DUBEW 020 160 S04	2	16	50	4		2DUBEW 070 340 S08	7	34	80	8	
2DUBEW 021 160 S04	2.1	16	50	4		2DUBEW 071 410 S08	7.1	41	80	8	
2DUBEW 022 160 S04	2.2	16	50	4		2DUBEW 072 410 S08	7.2	41	80	8	
2DUBEW 023 160 S04	2.3	16	50	4		2DUBEW 073 410 S08	7.3	41	80	8	
2DUBEW 024 160 S04	2.4	16	50	4		2DUBEW 074 410 S08	7.4	41	80	8	
2DUBEW 025 200 S04	2.5	20	50	4		2DUBEW 075 410 S08	7.5	41	80	8	
2DUBEW 026 200 S04	2.6	20	50	4		2DUBEW 076 410 S08	7.6	41	80	8	
2DUBEW 027 200 S04	2.7	20	50	4		2DUBEW 077 410 S08	7.7	41	80	8	
2DUBEW 028 200 S04	2.8	20	50	4		2DUBEW 078 410 S08	7.8	41	80	8	
2DUBEW 029 200 S04	2.9	20	50	4		2DUBEW 079 410 S08	7.9	41	80	8	
2DUBEW 030 200 S06	3	20	60	6		2DUBEW 080 410 S08	8	41	80	8	
2DUBEW 031 200 S06	3.1	20	60	6		2DUBEW 081 470 S10	8.1	47	90	10	
2DUBEW 032 200 S06	3.2	20	60	6		2DUBEW 082 470 S10	8.2	47	90	10	
2DUBEW 033 200 S06	3.3	20	60	6		2DUBEW 083 470 S10	8.3	47	90	10	
2DUBEW 034 200 S06	3.4	20	60	6		2DUBEW 084 470 S10	8.4	47	90	10	
2DUBEW 035 200 S06	3.5	20	60	6		2DUBEW 085 470 S10	8.5	47	90	10	
2DUBEW 036 200 S06	3.6	20	60	6		2DUBEW 086 470 S10	8.6	47	90	10	
2DUBEW 037 200 S06	3.7	20	60	6		2DUBEW 087 470 S10	8.7	47	90	10	
2DUBEW 038 240 S06	3.8	24	65	6		2DUBEW 088 470 S10	8.8	47	90	10	
2DUBEW 039 240 S06	3.9	24	65	6		2DUBEW 089 470 S10	8.9	47	90	10	
2DUBEW 040 240 S06	4	24	65	6		2DUBEW 090 470 S10	9	47	90	10	
2DUBEW 041 240 S06	4.1	24	65	6		2DUBEW 091 470 S10	9.1	47	90	10	
2DUBEW 042 240 S06	4.2	24	65	6		2DUBEW 092 470 S10	9.2	47	90	10	
2DUBEW 043 240 S06	4.3	24	65	6		2DUBEW 093 470 S10	9.3	47	90	10	
2DUBEW 044 240 S06	4.4	24	65	6		2DUBEW 094 470 S10	9.4	47	90	10	
2DUBEW 045 240 S06	4.5	24	65	6		2DUBEW 095 470 S10	9.5	47	90	10	
2DUBEW 046 240 S06	4.6	24	65	6		2DUBEW 096 470 S10	9.6	47	90	10	
2DUBEW 047 240 S06	4.7	24	65	6		2DUBEW 097 470 S10	9.7	47	90	10	
2DUBEW 048 280 S06	4.8	28	65	6		2DUBEW 098 470 S10	9.8	47	90	10	
2DUBEW 049 280 S06	4.9	28	65	6		2DUBEW 099 470 S10	9.9	47	90	10	
2DUBEW 050 280 S06	5	28	65	6		2DUBEW 100 470 S10	10	47	90	10	
2DUBEW 051 280 S06	5.1	28	65	6		2DUBEW 101 550 S12	10.1	55	100	12	
2DUBEW 052 280 S06	5.2	28	65	6		2DUBEW 102 550 S12	10.2	55	100	12	
2DUBEW 053 280 S06	5.3	28	65	6		2DUBEW 103 550 S12	10.3	55	100	12	
2DUBEW 054 280 S06	5.4	28	65	6		2DUBEW 104 550 S12	10.4	55	100	12	
2DUBEW 055 280 S06	5.5	28	65	6		2DUBEW 105 550 S12	10.5	55	100	12	
2DUBEW 056 280 S06	5.6	28	65	6		2DUBEW 106 550 S12	10.6	55	100	12	
2DUBEW 057 280 S06	5.7	28	65	6		2DUBEW 107 550 S12	10.7	55	100	12	
2DUBEW 058 280 S06	5.8	28	65	6		2DUBEW 108 550 S12	10.8	55	100	12	
2DUBEW 059 280 S06	5.9	28	65	6		2DUBEW 109 550 S12	10.9	55	100	12	

단위 : mm

Order Number	날경 Diameter D	홈길이 Flute Length L1	전장 Overall Length L	샙크 Dia d	비고	Order Number	날경 Diameter D	홈길이 Flute Length L1	전장 Overall Length L	샙크 Dia d	비고
2DUBEW 110 550 S12	11	55	100	12		2DUBEW 160 650 S16	16	65	115	16	
2DUBEW 111 550 S12	11.1	55	100	12		2DUBEW 161 730 S18	16.1	73	125	18	
2DUBEW 112 550 S12	11.2	55	100	12		2DUBEW 162 730 S18	16.2	73	125	18	
2DUBEW 113 550 S12	11.3	55	100	12		2DUBEW 163 730 S18	16.3	73	125	18	
2DUBEW 114 550 S12	11.4	55	100	12		2DUBEW 164 730 S18	16.4	73	125	18	
2DUBEW 115 550 S12	11.5	55	100	12		2DUBEW 165 730 S18	16.5	73	125	18	
2DUBEW 116 550 S12	11.6	55	100	12		2DUBEW 166 730 S18	16.6	73	125	18	
2DUBEW 117 550 S12	11.7	55	100	12		2DUBEW 167 730 S18	16.7	73	125	18	
2DUBEW 118 550 S12	11.8	55	100	12		2DUBEW 168 730 S18	16.8	73	125	18	
2DUBEW 119 550 S12	11.9	55	100	12		2DUBEW 169 730 S18	16.9	73	125	18	
2DUBEW 120 550 S12	12	55	100	12		2DUBEW 170 730 S18	17	73	125	18	
2DUBEW 121 600 S14	12.1	60	100	14		2DUBEW 171 730 S18	17.1	73	125	18	
2DUBEW 122 600 S14	12.2	60	100	14		2DUBEW 172 730 S18	17.2	73	125	18	
2DUBEW 123 600 S14	12.3	60	100	14		2DUBEW 173 730 S18	17.3	73	125	18	
2DUBEW 124 600 S14	12.4	60	100	14		2DUBEW 174 730 S18	17.4	73	125	18	
2DUBEW 125 600 S14	12.5	60	100	14		2DUBEW 175 730 S18	17.5	73	125	18	
2DUBEW 126 600 S14	12.6	60	100	14		2DUBEW 176 730 S18	17.6	73	125	18	
2DUBEW 127 600 S14	12.7	60	100	14		2DUBEW 177 730 S18	17.7	73	125	18	
2DUBEW 128 600 S14	12.8	60	100	14		2DUBEW 178 730 S18	17.8	73	125	18	
2DUBEW 129 600 S14	12.9	60	100	14		2DUBEW 179 730 S18	17.9	73	125	18	
2DUBEW 130 600 S14	13	60	100	14		2DUBEW 180 730 S18	18	73	125	18	
2DUBEW 131 600 S14	13.1	60	100	14		2DUBEW 181 790 S20	18.1	79	130	20	
2DUBEW 132 600 S14	13.2	60	105	14		2DUBEW 182 790 S20	18.2	79	130	20	
2DUBEW 133 600 S14	13.3	60	105	14		2DUBEW 183 790 S20	18.3	79	130	20	
2DUBEW 134 600 S14	13.4	60	105	14		2DUBEW 184 790 S20	18.4	79	130	20	
2DUBEW 135 600 S14	13.5	60	105	14		2DUBEW 185 790 S20	18.5	79	130	20	
2DUBEW 136 600 S14	13.6	60	105	14		2DUBEW 186 790 S20	18.6	79	130	20	
2DUBEW 137 600 S14	13.7	60	105	14		2DUBEW 187 790 S20	18.7	79	130	20	
2DUBEW 138 600 S14	13.8	60	105	14		2DUBEW 188 790 S20	18.8	79	130	20	
2DUBEW 139 600 S14	13.9	60	105	14		2DUBEW 189 790 S20	18.9	79	130	20	
2DUBEW 140 600 S14	14	60	105	14		2DUBEW 190 790 S20	19	79	130	20	
2DUBEW 141 650 S16	14.1	65	110	16		2DUBEW 191 790 S20	19.1	79	130	20	
2DUBEW 142 650 S16	14.2	65	110	16		2DUBEW 192 790 S20	19.2	79	130	20	
2DUBEW 143 650 S16	14.3	65	110	16		2DUBEW 193 790 S20	19.3	79	130	20	
2DUBEW 144 650 S16	14.4	65	110	16		2DUBEW 194 790 S20	19.4	79	130	20	
2DUBEW 145 650 S16	14.5	65	110	16		2DUBEW 195 790 S20	19.5	79	130	20	
2DUBEW 146 650 S16	14.6	65	110	16		2DUBEW 196 790 S20	19.6	79	130	20	
2DUBEW 147 650 S16	14.7	65	110	16		2DUBEW 197 790 S20	19.7	79	130	20	
2DUBEW 148 650 S16	14.8	65	110	16		2DUBEW 198 790 S20	19.8	79	130	20	
2DUBEW 149 650 S16	14.9	65	110	16		2DUBEW 199 790 S20	19.9	79	130	20	
2DUBEW 150 650 S16	15	65	110	16		2DUBEW 200 790 S20	20	79	130	20	
2DUBEW 151 650 S16	15.1	65	110	16							
2DUBEW 152 650 S16	15.2	65	115	16							
2DUBEW 153 650 S16	15.3	65	115	16							
2DUBEW 154 650 S16	15.4	65	115	16							
2DUBEW 155 650 S16	15.5	65	115	16							
2DUBEW 156 650 S16	15.6	65	115	16							
2DUBEW 157 650 S16	15.7	65	115	16							
2DUBEW 158 650 S16	15.8	65	115	16							
2DUBEW 159 650 S16	15.9	65	115	16							

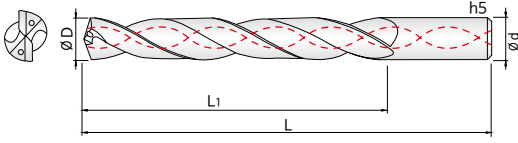

- SUS, Titanium, HRc28이하 SCM등의 합금용 난삭재 가공 드릴
- Cross cut 코팅을 적용하여 우수한 내열성과 내마모성으로 절삭영역을 확대하였습니다.
- 절삭 저항을 최소화하는 Point thinning을 채택 하였습니다.
- 최적에 플루트 형상 설계와 내부급유 방식을 적용하여 칩배출 성능이 매우 우수합니다.
- 140도 선단각 설계하여 높은 고정밀, 고속 드릴링 작업에 탁월한 성능을 발휘합니다.

**High-speed drills for SUS, alloy materials up to HRc28, SCM and Titanium**

- Minimized adhesion during drilling operations by applying cross-cut coating.
- Adopted point thinning to minimize cutting resistance.
- Excellent chip evacuation performance achieved by applying an optimal flute design and internal coolant system.
- Design with a 140-degree point angle for outstanding performance in high highprecision, high-speed drilling operations.

515P

단위 : mm

Order Number	날경 Diameter D	홈길이 Flute Length L1	전장 Overall Length L	샙크 Shank Dia d	비고	Order Number	날경 Diameter D	홈길이 Flute Length L1	전장 Overall Length L	샙크 Shank Dia d	비고
2DUBEW 010 100 S03	1	10	55	3		2DUBEW 060 440 S06	6	44	80	6	
2DUBEW 011 120 S03	1.1	12	55	3		2DUBEW 061 530 S08	6.1	53	90	8	
2DUBEW 012 120 S03	1.2	12	55	3		2DUBEW 062 530 S08	6.2	53	90	8	
2DUBEW 013 120 S03	1.3	12	55	3		2DUBEW 063 530 S08	6.3	53	90	8	
2DUBEW 014 120 S03	1.4	12	55	3		2DUBEW 064 530 S08	6.4	53	90	8	
2DUBEW 015 120 S03	1.5	12	55	3		2DUBEW 065 530 S08	6.5	53	90	8	
2DUBEW 016 160 S03	1.6	16	55	3		2DUBEW 066 530 S08	6.6	53	90	8	
2DUBEW 017 160 S03	1.7	16	55	3		2DUBEW 067 530 S08	6.7	53	90	8	
2DUBEW 018 160 S03	1.8	16	55	3		2DUBEW 068 530 S08	6.8	53	90	8	
2DUBEW 019 160 S03	1.9	16	55	3		2DUBEW 069 530 S08	6.9	53	90	8	
2DUBEW 020 210 S04	2	21	55	4		2DUBEW 070 530 S08	7	53	90	8	
2DUBEW 021 210 S04	2.1	21	55	4		2DUBEW 071 530 S08	7.1	53	90	8	
2DUBEW 022 210 S04	2.2	21	55	4		2DUBEW 072 530 S08	7.2	53	90	8	
2DUBEW 023 210 S04	2.3	21	55	4		2DUBEW 073 530 S08	7.3	53	90	8	
2DUBEW 024 210 S04	2.4	21	55	4		2DUBEW 074 530 S08	7.4	53	90	8	
2DUBEW 025 210 S04	2.5	21	55	4		2DUBEW 075 530 S08	7.5	53	90	8	
2DUBEW 026 210 S04	2.6	21	55	4		2DUBEW 076 530 S08	7.6	53	90	8	
2DUBEW 027 210 S04	2.7	21	55	4		2DUBEW 077 530 S08	7.7	53	90	8	
2DUBEW 028 210 S04	2.8	21	55	4		2DUBEW 078 530 S08	7.8	53	90	8	
2DUBEW 029 210 S04	2.9	21	55	4		2DUBEW 079 530 S08	7.9	53	90	8	
2DUBEW 030 280 S06	3	28	65	6		2DUBEW 080 530 S08	8	53	90	8	
2DUBEW 031 280 S06	3.1	28	65	6		2DUBEW 081 610 S10	8.1	61	105	10	
2DUBEW 032 280 S06	3.2	28	65	6		2DUBEW 082 610 S10	8.2	61	105	10	
2DUBEW 033 280 S06	3.3	28	65	6		2DUBEW 083 610 S10	8.3	61	105	10	
2DUBEW 034 280 S06	3.4	28	65	6		2DUBEW 084 610 S10	8.4	61	105	10	
2DUBEW 035 280 S06	3.5	28	65	6		2DUBEW 085 610 S10	8.5	61	105	10	
2DUBEW 036 280 S06	3.6	28	65	6		2DUBEW 086 610 S10	8.6	61	105	10	
2DUBEW 037 280 S06	3.7	28	65	6		2DUBEW 087 610 S10	8.7	61	105	10	
2DUBEW 038 360 S06	3.8	36	75	6		2DUBEW 088 610 S10	8.8	61	105	10	
2DUBEW 039 360 S06	3.9	36	75	6		2DUBEW 089 610 S10	8.9	61	105	10	
2DUBEW 040 360 S06	4	36	75	6		2DUBEW 090 610 S10	9	61	105	10	
2DUBEW 041 360 S06	4.1	36	75	6		2DUBEW 091 610 S10	9.1	61	105	10	
2DUBEW 042 360 S06	4.2	36	75	6		2DUBEW 092 610 S10	9.2	61	105	10	
2DUBEW 043 360 S06	4.3	36	75	6		2DUBEW 093 610 S10	9.3	61	105	10	
2DUBEW 044 360 S06	4.4	36	75	6		2DUBEW 094 610 S10	9.4	61	105	10	
2DUBEW 045 360 S06	4.5	36	75	6		2DUBEW 095 610 S10	9.5	61	105	10	
2DUBEW 046 360 S06	4.6	36	75	6		2DUBEW 096 610 S10	9.6	61	105	10	
2DUBEW 047 360 S06	4.7	36	75	6		2DUBEW 097 610 S10	9.7	61	105	10	
2DUBEW 048 440 S06	4.8	44	80	6		2DUBEW 098 610 S10	9.8	61	105	10	
2DUBEW 049 440 S06	4.9	44	80	6		2DUBEW 099 610 S10	9.9	61	105	10	
2DUBEW 050 440 S06	5	44	80	6		2DUBEW 100 610 S10	10	61	105	10	
2DUBEW 051 440 S06	5.1	44	80	6		2DUBEW 101 710 S12	10.1	71	120	12	
2DUBEW 052 440 S06	5.2	44	80	6		2DUBEW 102 710 S12	10.2	71	120	12	
2DUBEW 053 440 S06	5.3	44	80	6		2DUBEW 103 710 S12	10.3	71	120	12	
2DUBEW 054 440 S06	5.4	44	80	6		2DUBEW 104 710 S12	10.4	71	120	12	
2DUBEW 055 440 S06	5.5	44	80	6		2DUBEW 105 710 S12	10.5	71	120	12	
2DUBEW 056 440 S06	5.6	44	80	6		2DUBEW 106 710 S12	10.6	71	120	12	
2DUBEW 057 440 S06	5.7	44	80	6		2DUBEW 107 710 S12	10.7	71	120	12	
2DUBEW 058 440 S06	5.8	44	80	6		2DUBEW 108 710 S12	10.8	71	120	12	
2DUBEW 059 440 S06	5.9	44	80	6		2DUBEW 109 710 S12	10.9	71	120	12	

DRILL

단위 : mm

Order Number	날경 Diameter D	홈길이 Flute Length L1	전장 Overall Length L	샙크 Dia d	비고	Order Number	날경 Diameter D	홈길이 Flute Length L1	전장 Overall Length L	샙크 Dia d	비고
2DUBEW 110 710 S12	11	71	120	12		2DUBEW 160 830 S16	16	83	135	16	
2DUBEW 111 710 S12	11.1	71	120	12		2DUBEW 161 930 S18	16.1	93	145	18	
2DUBEW 112 710 S12	11.2	71	120	12		2DUBEW 162 930 S18	16.2	93	145	18	
2DUBEW 113 710 S12	11.3	71	120	12		2DUBEW 163 930 S18	16.3	93	145	18	
2DUBEW 114 710 S12	11.4	71	120	12		2DUBEW 164 930 S18	16.4	93	145	18	
2DUBEW 115 710 S12	11.5	71	120	12		2DUBEW 165 930 S18	16.5	93	145	18	
2DUBEW 116 710 S12	11.6	71	120	12		2DUBEW 166 930 S18	16.6	93	145	18	
2DUBEW 117 710 S12	11.7	71	120	12		2DUBEW 167 930 S18	16.7	93	145	18	
2DUBEW 118 710 S12	11.8	71	120	12		2DUBEW 168 930 S18	16.8	93	145	18	
2DUBEW 119 710 S12	11.9	71	120	12		2DUBEW 169 930 S18	16.9	93	145	18	
2DUBEW 120 710 S12	12	71	120	12		2DUBEW 170 930 S18	17	93	145	18	
2DUBEW 121 770 S14	12.1	77	125	14		2DUBEW 171 930 S18	17.1	93	145	18	
2DUBEW 122 770 S14	12.2	77	125	14		2DUBEW 172 930 S18	17.2	93	145	18	
2DUBEW 123 770 S14	12.3	77	125	14		2DUBEW 173 930 S18	17.3	93	145	18	
2DUBEW 124 770 S14	12.4	77	125	14		2DUBEW 174 930 S18	17.4	93	145	18	
2DUBEW 125 770 S14	12.5	77	125	14		2DUBEW 175 930 S18	17.5	93	145	18	
2DUBEW 126 770 S14	12.6	77	125	14		2DUBEW 176 930 S18	17.6	93	145	18	
2DUBEW 127 770 S14	12.7	77	125	14		2DUBEW 177 930 S18	17.7	93	145	18	
2DUBEW 128 770 S14	12.8	77	125	14		2DUBEW 178 930 S18	17.8	93	145	18	
2DUBEW 129 770 S14	12.9	77	125	14		2DUBEW 179 930 S18	17.9	93	145	18	
2DUBEW 130 770 S14	13	77	125	14		2DUBEW 180 930 S18	18	93	145	18	
2DUBEW 131 770 S14	13.1	77	125	14		2DUBEW 181 1010 S20	18.1	101	155	20	
2DUBEW 132 770 S14	13.2	77	125	14		2DUBEW 182 1010 S20	18.2	101	155	20	
2DUBEW 133 770 S14	13.3	77	125	14		2DUBEW 183 1010 S20	18.3	101	155	20	
2DUBEW 134 770 S14	13.4	77	125	14		2DUBEW 184 1010 S20	18.4	101	155	20	
2DUBEW 135 770 S14	13.5	77	125	14		2DUBEW 185 1010 S20	18.5	101	155	20	
2DUBEW 136 770 S14	13.6	77	125	14		2DUBEW 186 1010 S20	18.6	101	155	20	
2DUBEW 137 770 S14	13.7	77	125	14		2DUBEW 187 1010 S20	18.7	101	155	20	
2DUBEW 138 770 S14	13.8	77	125	14		2DUBEW 188 1010 S20	18.8	101	155	20	
2DUBEW 139 770 S14	13.9	77	125	14		2DUBEW 189 1010 S20	18.9	101	155	20	
2DUBEW 140 770 S14	14	77	125	14		2DUBEW 190 1010 S20	19	101	155	20	
2DUBEW 141 830 S16	14.1	83	135	16		2DUBEW 191 1010 S20	19.1	101	155	20	
2DUBEW 142 830 S16	14.2	83	135	16		2DUBEW 192 1010 S20	19.2	101	155	20	
2DUBEW 143 830 S16	14.3	83	135	16		2DUBEW 193 1010 S20	19.3	101	155	20	
2DUBEW 144 830 S16	14.4	83	135	16		2DUBEW 194 1010 S20	19.4	101	155	20	
2DUBEW 145 830 S16	14.5	83	135	16		2DUBEW 195 1010 S20	19.5	101	155	20	
2DUBEW 146 830 S16	14.6	83	135	16		2DUBEW 196 1010 S20	19.6	101	155	20	
2DUBEW 147 830 S16	14.7	83	135	16		2DUBEW 197 1010 S20	19.7	101	155	20	
2DUBEW 148 830 S16	14.8	83	135	16		2DUBEW 198 1010 S20	19.8	101	155	20	
2DUBEW 149 830 S16	14.9	83	135	16		2DUBEW 199 1010 S20	19.9	101	155	20	
2DUBEW 150 830 S16	15	83	135	16		2DUBEW 200 1010 S20	20	101	155	20	
2DUBEW 151 830 S16	15.1	83	135	16							
2DUBEW 152 830 S16	15.2	83	135	16							
2DUBEW 153 830 S16	15.3	83	135	16							
2DUBEW 154 830 S16	15.4	83	135	16							
2DUBEW 155 830 S16	15.5	83	135	16							
2DUBEW 156 830 S16	15.6	83	135	16							
2DUBEW 157 830 S16	15.7	83	135	16							
2DUBEW 158 830 S16	15.8	83	135	16							
2DUBEW 159 830 S16	15.9	83	135	16							



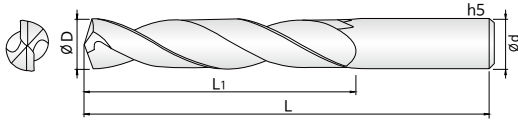

- 알루미늄 주물, 알루미늄 다이캐스팅, 비철금속, 플라스틱 등 비철 비금속 계열 전용 드릴
- 비철금속 드릴링의 최적화 된 설계로 칩 응착을 최소화 하였습니다.
- 최적인 플루트 형상을 적용하여 안정적인 칩 배출과 절삭성이 우수합니다.
- 폭넓은 비철금속 피삭재에 적용 가능합니다.
- 우수한 제품의 강성과 칩 배출을 고려한 플루트 홈 설계를 적용하였습니다.

**Drills for aluminum casting, aluminum die casting, non-ferrous metal, plastic and etc.**

- Chip fusion is minimized with an optimized design for non-ferrous metal drilling.
- Provides stable chip evacuation and excellent cutting performance by optimized flute design.
- Applicable for various kinds of non-ferrous metals.
- Applied flute groove design considering the excellent rigidity of the product and chip evacuation.



516P

단위 : mm

Order Number	날경 Diameter D	홈길이 Flute Length L1	전장 Overall Length L	샙크 Shank Dia d	비고	Order Number	날경 Diameter D	홈길이 Flute Length L1	전장 Overall Length L	샙크 Shank Dia d	비고
2DUBEN 010 060 S03	1	6	26	3		2DUBEN 060 280 S06	6	28	65	6	
2DUBEN 011 070 S03	1.1	7	28	3		2DUBEN 061 310 S07	6.1	31	70	7	
2DUBEN 012 080 S03	1.2	8	30	3		2DUBEN 062 310 S07	6.2	31	70	7	
2DUBEN 013 080 S03	1.3	8	30	3		2DUBEN 063 310 S07	6.3	31	70	7	
2DUBEN 014 090 S03	1.4	9	32	3		2DUBEN 064 310 S07	6.4	31	70	7	
2DUBEN 015 090 S03	1.5	9	32	3		2DUBEN 065 310 S07	6.5	31	70	7	
2DUBEN 016 100 S03	1.6	10	34	3		2DUBEN 066 310 S07	6.6	31	70	7	
2DUBEN 017 100 S03	1.7	10	34	3		2DUBEN 067 310 S07	6.7	31	70	7	
2DUBEN 018 110 S03	1.8	11	36	3		2DUBEN 068 340 S07	6.8	34	75	7	
2DUBEN 019 110 S03	1.9	11	36	3		2DUBEN 069 340 S07	6.9	34	75	7	
2DUBEN 020 120 S03	2	12	38	3		2DUBEN 070 340 S07	7	34	75	7	
2DUBEN 021 120 S03	2.1	12	40	3		2DUBEN 071 340 S08	7.1	34	75	8	
2DUBEN 022 130 S03	2.2	13	40	3		2DUBEN 072 340 S08	7.2	34	75	8	
2DUBEN 023 130 S03	2.3	13	40	3		2DUBEN 073 340 S08	7.3	34	75	8	
2DUBEN 024 140 S03	2.4	14	45	3		2DUBEN 074 340 S08	7.4	34	75	8	
2DUBEN 025 140 S03	2.5	14	45	3		2DUBEN 075 340 S08	7.5	34	75	8	
2DUBEN 026 140 S03	2.6	14	45	3		2DUBEN 076 370 S08	7.6	37	80	8	
2DUBEN 027 160 S03	2.7	16	45	3		2DUBEN 077 370 S08	7.7	37	80	8	
2DUBEN 028 160 S03	2.8	16	45	3		2DUBEN 078 370 S08	7.8	37	80	8	
2DUBEN 029 160 S03	2.9	16	45	3		2DUBEN 079 370 S08	7.9	37	80	8	
2DUBEN 030 160 S03	3	16	45	3		2DUBEN 080 370 S08	8	37	80	8	
2DUBEN 031 180 S04	3.1	18	50	4		2DUBEN 081 370 S09	8.1	37	80	9	
2DUBEN 032 180 S04	3.2	18	50	4		2DUBEN 082 370 S09	8.2	37	80	9	
2DUBEN 033 180 S04	3.3	18	50	4		2DUBEN 083 370 S09	8.3	37	80	9	
2DUBEN 034 200 S04	3.4	20	55	4		2DUBEN 084 370 S09	8.4	37	80	9	
2DUBEN 035 200 S04	3.5	20	55	4		2DUBEN 085 370 S09	8.5	37	80	9	
2DUBEN 036 200 S04	3.6	20	55	4		2DUBEN 086 400 S09	8.6	40	85	9	
2DUBEN 037 200 S04	3.7	20	55	4		2DUBEN 087 400 S09	8.7	40	85	9	
2DUBEN 038 220 S04	3.8	22	55	4		2DUBEN 088 400 S09	8.8	40	85	9	
2DUBEN 039 220 S04	3.9	22	55	4		2DUBEN 089 400 S09	8.9	40	85	9	
2DUBEN 040 220 S04	4	22	55	4		2DUBEN 090 400 S09	9	40	85	9	
2DUBEN 041 220 S05	4.1	22	55	5		2DUBEN 091 400 S10	9.1	40	85	10	
2DUBEN 042 220 S05	4.2	22	55	5		2DUBEN 092 400 S10	9.2	40	85	10	
2DUBEN 043 240 S05	4.3	24	60	5		2DUBEN 093 400 S10	9.3	40	85	10	
2DUBEN 044 240 S05	4.4	24	60	5		2DUBEN 094 400 S10	9.4	40	85	10	
2DUBEN 045 240 S05	4.5	24	60	5		2DUBEN 095 400 S10	9.5	40	85	10	
2DUBEN 046 240 S05	4.6	24	60	5		2DUBEN 096 400 S10	9.6	40	90	10	
2DUBEN 047 240 S05	4.7	24	60	5		2DUBEN 097 430 S10	9.7	43	90	10	
2DUBEN 048 260 S05	4.8	26	65	5		2DUBEN 098 430 S10	9.8	43	90	10	
2DUBEN 049 260 S05	4.9	26	65	5		2DUBEN 099 430 S10	9.9	43	90	10	
2DUBEN 050 260 S05	5	26	65	5		2DUBEN 100 430 S10	10	43	90	10	
2DUBEN 051 260 S06	5.1	26	65	6		2DUBEN 101 430 S11	10.1	43	90	11	
2DUBEN 052 260 S06	5.2	26	65	6		2DUBEN 102 430 S11	10.2	43	90	11	
2DUBEN 053 260 S06	5.3	26	65	6		2DUBEN 103 430 S11	10.3	43	90	11	
2DUBEN 054 280 S06	5.4	28	65	6		2DUBEN 104 430 S11	10.4	43	90	11	
2DUBEN 055 280 S06	5.5	28	65	6		2DUBEN 105 430 S11	10.5	43	90	11	
2DUBEN 056 280 S06	5.6	28	65	6		2DUBEN 106 430 S11	10.6	43	90	11	
2DUBEN 057 280 S06	5.7	28	65	6		2DUBEN 107 470 S11	10.7	47	95	11	
2DUBEN 058 280 S06	5.8	28	65	6		2DUBEN 108 470 S11	10.8	47	95	11	
2DUBEN 059 280 S06	5.9	28	65	6		2DUBEN 109 470 S11	10.9	47	95	11	

단위 : mm

Order Number	날경 Diameter D	홈길이 Flute Length L1	전장 Overall Length L	생크 Shank Dia d	비고	Order Number	날경 Diameter D	홈길이 Flute Length L1	전장 Overall Length L	생크 Shank Dia d	비고
2DUBEN 110 470 S11	11	47	95	11							
2DUBEN 111 470 S12	11.1	47	95	12							
2DUBEN 112 470 S12	11.2	47	95	12							
2DUBEN 113 470 S12	11.3	47	95	12							
2DUBEN 114 470 S12	11.4	47	95	12							
2DUBEN 115 470 S12	11.5	47	95	12							
2DUBEN 116 470 S12	11.6	47	95	12							
2DUBEN 117 470 S12	11.7	47	95	12							
2DUBEN 118 470 S12	11.8	47	95	12							
2DUBEN 119 510 S12	11.9	51	100	12							
2DUBEN 120 510 S12	12	51	100	12							
2DUBEN 121 510 S13	12.1	51	100	13							
2DUBEN 122 510 S13	12.2	51	100	13							
2DUBEN 123 510 S13	12.3	51	100	13							
2DUBEN 124 510 S13	12.4	51	100	13							
2DUBEN 125 510 S13	12.5	51	100	13							
2DUBEN 126 510 S13	12.6	51	100	13							
2DUBEN 127 510 S13	12.7	51	100	13							
2DUBEN 128 510 S13	12.8	51	100	13							
2DUBEN 129 510 S13	12.9	51	100	13							
2DUBEN 130 510 S13	13	51	100	13							

### 초경 2날 두배 N 드릴 [5XD]

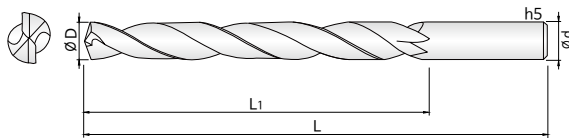

- 알루미늄 주물, 알루미늄 다이캐스팅, 비철금속, 플라스틱 등 비철 비금속 계열 전용 드릴
- 비철금속 드릴링의 최적화 된 설계로 칩 융착을 최소화 하였습니다.
- 최적의 플루트 형상을 적용하여 안정적인 칩 배출과 절삭성이 우수합니다.
- 폭넓은 비철금속 피삭재에 적용 가능합니다.
- 우수한 제품의 강성과 칩 배출을 고려한 플루트 홈 설계를 적용하였습니다.

- Drills for aluminum casting, aluminum die casting, non-ferrous metal, plastics and etc.
- Chip fusion is minimized with an optimized design for non-ferrous metal drilling.
- Provides stable chip evacuation and excellent cutting performance by optimized flute design.
- Applicable for various kinds of non-ferrous metals.
- Applied flute groove design considering the excellent rigidity of the product and chip evacuation.



516P

단위 : mm

Order Number	날경 Diameter D	홈길이 Flute Length L1	전장 Overall Length L	샙크 Shank Dia d	비고	Order Number	날경 Diameter D	홈길이 Flute Length L1	전장 Overall Length L	샙크 Shank Dia d	비고
2DUBEN 010 120 S03	1	12	34	3		2DUBEN 060 570 S06	6	57	95	6	
2DUBEN 011 140 S03	1.1	14	36	3		2DUBEN 061 630 S07	6.1	63	100	7	
2DUBEN 012 160 S03	1.2	16	38	3		2DUBEN 062 630 S07	6.2	63	100	7	
2DUBEN 013 160 S03	1.3	16	38	3		2DUBEN 063 630 S07	6.3	63	100	7	
2DUBEN 014 180 S03	1.4	18	40	3		2DUBEN 064 630 S07	6.4	63	100	7	
2DUBEN 015 180 S03	1.5	18	40	3		2DUBEN 065 630 S07	6.5	63	100	7	
2DUBEN 016 200 S03	1.6	20	43	3		2DUBEN 066 630 S07	6.6	63	100	7	
2DUBEN 017 200 S03	1.7	20	46	3		2DUBEN 067 630 S07	6.7	63	100	7	
2DUBEN 018 220 S03	1.8	22	46	3		2DUBEN 068 690 S07	6.8	69	110	7	
2DUBEN 019 220 S03	1.9	22	49	3		2DUBEN 069 690 S07	6.9	69	110	7	
2DUBEN 020 240 S03	2	24	55	3		2DUBEN 070 690 S07	7	69	110	7	
2DUBEN 021 240 S03	2.1	24	55	3		2DUBEN 071 690 S08	7.1	69	110	8	
2DUBEN 022 270 S03	2.2	27	60	3		2DUBEN 072 690 S08	7.2	69	110	8	
2DUBEN 023 270 S03	2.3	27	60	3		2DUBEN 073 690 S08	7.3	69	110	8	
2DUBEN 024 300 S03	2.4	30	60	3		2DUBEN 074 690 S08	7.4	69	110	8	
2DUBEN 025 300 S03	2.5	30	60	3		2DUBEN 075 690 S08	7.5	69	110	8	
2DUBEN 026 300 S03	2.6	30	60	3		2DUBEN 076 750 S08	7.6	75	120	8	
2DUBEN 027 330 S03	2.7	33	65	3		2DUBEN 077 750 S08	7.7	75	120	8	
2DUBEN 028 330 S03	2.8	33	65	3		2DUBEN 078 750 S08	7.8	75	120	8	
2DUBEN 029 330 S03	2.9	33	65	3		2DUBEN 079 750 S08	7.9	75	120	8	
2DUBEN 030 330 S03	3	33	65	3		2DUBEN 080 750 S08	8	75	120	8	
2DUBEN 031 360 S04	3.1	36	65	4		2DUBEN 081 750 S09	8.1	75	120	9	
2DUBEN 032 360 S04	3.2	36	65	4		2DUBEN 082 750 S09	8.2	75	120	9	
2DUBEN 033 360 S04	3.3	36	65	4		2DUBEN 083 750 S09	8.3	75	120	9	
2DUBEN 034 390 S04	3.4	39	70	4		2DUBEN 084 750 S09	8.4	75	120	9	
2DUBEN 035 390 S04	3.5	39	70	4		2DUBEN 085 750 S09	8.5	75	120	9	
2DUBEN 036 390 S04	3.6	39	70	4		2DUBEN 086 810 S09	8.6	81	125	9	
2DUBEN 037 390 S04	3.7	39	70	4		2DUBEN 087 810 S09	8.7	81	125	9	
2DUBEN 038 430 S04	3.8	43	70	4		2DUBEN 088 810 S09	8.8	81	125	9	
2DUBEN 039 430 S04	3.9	43	75	4		2DUBEN 089 810 S09	8.9	81	125	9	
2DUBEN 040 430 S04	4	43	75	4		2DUBEN 090 810 S09	9	81	125	9	
2DUBEN 041 430 S05	4.1	43	75	5		2DUBEN 091 810 S10	9.1	81	125	10	
2DUBEN 042 430 S05	4.2	43	75	5		2DUBEN 092 810 S10	9.2	81	125	10	
2DUBEN 043 470 S05	4.3	47	80	5		2DUBEN 093 810 S10	9.3	81	125	10	
2DUBEN 044 470 S05	4.4	47	80	5		2DUBEN 094 810 S10	9.4	81	125	10	
2DUBEN 045 470 S05	4.5	47	80	5		2DUBEN 095 810 S10	9.5	81	125	10	
2DUBEN 046 470 S05	4.6	47	80	5		2DUBEN 096 870 S10	9.6	87	135	10	
2DUBEN 047 470 S05	4.7	47	80	5		2DUBEN 097 870 S10	9.7	87	135	10	
2DUBEN 048 520 S05	4.8	52	85	5		2DUBEN 098 870 S10	9.8	87	135	10	
2DUBEN 049 520 S05	4.9	52	85	5		2DUBEN 099 870 S10	9.9	87	135	10	
2DUBEN 050 520 S05	5	52	85	5		2DUBEN 100 870 S10	10	87	135	10	
2DUBEN 051 520 S06	5.1	52	85	6		2DUBEN 101 870 S11	10.1	87	135	11	
2DUBEN 052 520 S06	5.2	52	85	6		2DUBEN 102 870 S11	10.2	87	135	11	
2DUBEN 053 520 S06	5.3	52	85	6		2DUBEN 103 870 S11	10.3	87	135	11	
2DUBEN 054 570 S06	5.4	57	95	6		2DUBEN 104 870 S11	10.4	87	135	11	
2DUBEN 055 570 S06	5.5	57	95	6		2DUBEN 105 870 S11	10.5	87	135	11	
2DUBEN 056 570 S06	5.6	57	95	6		2DUBEN 106 870 S11	10.6	87	135	11	
2DUBEN 057 570 S06	5.7	57	95	6		2DUBEN 107 940 S11	10.7	94	145	11	
2DUBEN 058 570 S06	5.8	57	95	6		2DUBEN 108 940 S11	10.8	94	145	11	
2DUBEN 059 570 S06	5.9	57	95	6		2DUBEN 109 940 S11	10.9	94	145	11	

DRILL

단위 : mm

Order Number	날경 Diameter D	홈길이 Flute Length L1	전장 Overall Length L	생크 Shank Dia d	비고	Order Number	날경 Diameter D	홈길이 Flute Length L1	전장 Overall Length L	생크 Shank Dia d	비고
2DUBEN 110 940 S11	11	94	145	11							
2DUBEN 111 940 S12	11.1	94	145	12							
2DUBEN 112 940 S12	11.2	94	145	12							
2DUBEN 113 940 S12	11.3	94	145	12							
2DUBEN 114 940 S12	11.4	94	145	12							
2DUBEN 115 940 S12	11.5	94	145	12							
2DUBEN 116 940 S12	11.6	94	145	12							
2DUBEN 117 940 S12	11.7	94	145	12							
2DUBEN 118 940 S12	11.8	94	145	12							
2DUBEN 119 1010 S12	11.9	101	150	12							
2DUBEN 120 1010 S12	12	101	150	12							
2DUBEN 121 1010 S13	12.1	101	150	13							
2DUBEN 122 1010 S13	12.2	101	150	13							
2DUBEN 123 1010 S13	12.3	101	150	13							
2DUBEN 124 1010 S13	12.4	101	150	13							
2DUBEN 125 1010 S13	12.5	101	150	13							
2DUBEN 126 1010 S13	12.6	101	150	13							
2DUBEN 127 1010 S13	12.7	101	150	13							
2DUBEN 128 1010 S13	12.8	101	150	13							
2DUBEN 129 1010 S13	12.9	101	150	13							
2DUBEN 130 1010 S13	13	101	150	13							

DRILL





단위 : mm

Order Number	날경 Diameter D	홈길이 Flute Length L1	유효장 Effective Length L2	전장 Overall Length L	샙크 Shank Dia d	비고	Order Number	날경 Diameter D	홈길이 Flute Length L1	유효장 Effective Length L2	전장 Overall Length L	샙크 Shank Dia d	비고
2FDR 094 404 S10	9.4	37.6	40.4	80	10		2FDR 144 619 S16	14.4	57.6	61.9	105	16	
2FDR 095 409 S10	9.5	38	40.9	80	10		2FDR 145 624 S16	14.5	58	62.4	105	16	
2FDR 096 413 S10	9.6	38.4	41.3	80	10		2FDR 146 628 S16	14.6	58.4	62.8	105	16	
2FDR 097 417 S10	9.7	38.8	41.7	80	10		2FDR 147 632 S16	14.7	58.8	63.2	105	16	
2FDR 098 421 S10	9.8	39.2	42.1	80	10		2FDR 148 636 S16	14.8	59.2	63.6	105	16	
2FDR 099 426 S10	9.9	39.6	42.6	80	10		2FDR 149 641 S16	14.9	59.6	64.1	105	16	
2FDR 100 430 S10	10	40	43	80	10		2FDR 150 645 S16	15	60	64.5	105	16	
2FDR 101 434 S12	10.1	40.4	43.4	90	12		2FDR 151 649 S16	15.1	60.4	64.9	115	16	
2FDR 102 439 S12	10.2	40.8	43.9	90	12		2FDR 152 654 S16	15.2	60.8	65.4	115	16	
2FDR 103 443 S12	10.3	41.2	44.3	90	12		2FDR 153 658 S16	15.3	61.2	65.8	115	16	
2FDR 104 447 S12	10.4	41.6	44.7	90	12		2FDR 154 662 S16	15.4	61.6	66.2	115	16	
2FDR 105 452 S12	10.5	42	45.2	90	12		2FDR 155 667 S16	15.5	62	66.7	115	16	
2FDR 106 456 S12	10.6	42.4	45.6	90	12		2FDR 156 671 S16	15.6	62.4	67.1	115	16	
2FDR 107 460 S12	10.7	42.8	46	90	12		2FDR 157 675 S16	15.7	62.8	67.5	115	16	
2FDR 108 464 S12	10.8	43.2	46.4	90	12		2FDR 158 679 S16	15.8	63.2	67.9	115	16	
2FDR 109 469 S12	10.9	43.6	46.9	90	12		2FDR 159 684 S16	15.9	63.6	68.4	115	16	
2FDR 110 473 S12	11	44	47.3	90	12		2FDR 160 688 S16	16	64	68.8	115	16	
2FDR 111 477 S12	11.1	44.4	47.7	90	12		2FDR 165 710 S18	16.5	66	71	125	18	
2FDR 112 482 S12	11.2	44.8	48.2	90	12		2FDR 170 731 S18	17	68	73.1	125	18	
2FDR 113 486 S12	11.3	45.2	48.6	90	12		2FDR 175 753 S18	17.5	70	75.3	125	18	
2FDR 114 490 S12	11.4	45.6	49	90	12		2FDR 180 774 S18	18	72	77.4	125	18	
2FDR 115 495 S12	11.5	46	49.5	90	12		2FDR 185 796 S20	18.5	74	79.6	135	20	
2FDR 116 499 S12	11.6	46.4	49.9	90	12		2FDR 190 817 S20	19	76	81.7	135	20	
2FDR 117 503 S12	11.7	46.8	50.3	90	12		2FDR 195 839 S20	19.5	78	83.9	145	20	
2FDR 118 507 S12	11.8	47.2	50.7	90	12		2FDR 200 860 S20	20	80	86	145	20	
2FDR 119 512 S12	11.9	47.6	51.2	90	12								
2FDR 120 516 S12	12	48	51.6	90	12								
2FDR 121 520 S14	12.1	48.4	52	100	14								
2FDR 122 525 S14	12.2	48.8	52.5	100	14								
2FDR 123 529 S14	12.3	49.2	52.9	100	14								
2FDR 124 533 S14	12.4	49.6	53.3	100	14								
2FDR 125 538 S14	12.5	50	53.8	100	14								
2FDR 126 542 S14	12.6	50.4	54.2	100	14								
2FDR 127 546 S14	12.7	50.8	54.6	100	14								
2FDR 128 550 S14	12.8	51.2	55	100	14								
2FDR 129 555 S14	12.9	51.6	55.5	100	14								
2FDR 130 559 S14	13	52	55.9	100	14								
2FDR 131 563 S14	13.1	52.4	56.3	100	14								
2FDR 132 568 S14	13.2	52.8	56.8	100	14								
2FDR 133 572 S14	13.3	53.2	57.2	100	14								
2FDR 134 576 S14	13.4	53.6	57.6	100	14								
2FDR 135 581 S14	13.5	54	58.1	100	14								
2FDR 136 585 S14	13.6	54.4	58.5	100	14								
2FDR 137 589 S14	13.7	54.8	58.9	100	14								
2FDR 138 593 S14	13.8	55.2	59.3	100	14								
2FDR 139 598 S14	13.9	55.6	59.8	100	14								
2FDR 140 602 S14	14	56	60.2	100	14								
2FDR 141 606 S16	14.1	56.4	60.6	105	16								
2FDR 142 611 S16	14.2	56.8	61.1	105	16								
2FDR 143 615 S16	14.3	57.2	61.5	105	16								

### 초경 2날/ 롱샹크 다기능 플랫 드릴

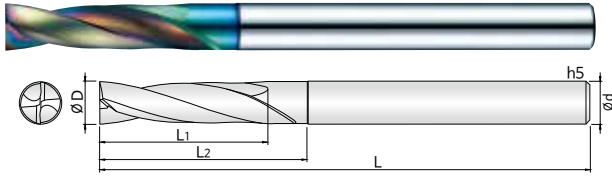

- HRc50이하, 프리하든강, 합금강, 주철 가공용 플랫 드릴
- 밀날 플랫타입으로 다양한 경사면과 곡면 드릴가공에 탁월한 성능을 발휘합니다.
- 20도 헬릭스를 채택하여 칩배출 성능이 매우 우수합니다.
- 관통 드릴 작업시 버 발생을 최소화 합니다.
- HR 코팅으로 내열성과 내마모성이 우수, 긴 공구수명을 실현 하였습니다.

### Flat drills for materials up to HRc50, pre-hardened steels, alloy steels, cast irons

- With flat type of end face, excellent performance drilling is available to a variety of inclined and curved surfaces.
- Chip emission is great and stable drilling is available with 20 degree helix design.
- Minimize burrs during penetration drilling.
- Increased tool life by applying HR coating with great heat and wear resistance.



517P

Order Number	Diameter D	Flute Length L1	Effective Length L2	Overall Length L	Shank Dia d	비고	Order Number	Diameter D	Flute Length L1	Effective Length L2	Overall Length L	Shank Dia d	비고
2FDRL 030 300 S06	3	12	30	100	6		2FDRL 084 672 S10	8.4	33.6	67.2	130	10	
2FDRL 031 310 S06	3.1	12.4	31	100	6		2FDRL 085 680 S10	8.5	34	68	130	10	
2FDRL 032 320 S06	3.2	12.8	32	100	6		2FDRL 086 688 S10	8.6	34.4	68.8	130	10	
2FDRL 033 330 S06	3.3	13.2	33	100	6		2FDRL 087 696 S10	8.7	34.8	69.6	130	10	
2FDRL 034 340 S06	3.4	13.6	34	100	6		2FDRL 088 704 S10	8.8	35.2	70.4	130	10	
2FDRL 035 350 S06	3.5	14	35	100	6		2FDRL 089 712 S10	8.9	35.6	71.2	130	10	
2FDRL 036 360 S06	3.6	14.4	36	100	6		2FDRL 090 720 S10	9	36	72	130	10	
2FDRL 037 370 S06	3.7	14.8	37	100	6		2FDRL 091 728 S10	9.1	36.4	72.8	130	10	
2FDRL 038 380 S06	3.8	15.2	38	100	6		2FDRL 092 736 S10	9.2	36.8	73.6	130	10	
2FDRL 039 390 S06	3.9	15.6	39	100	6		2FDRL 093 744 S10	9.3	37.2	74.4	130	10	
2FDRL 040 400 S06	4	16	40	100	6		2FDRL 094 752 S10	9.4	37.6	75.2	130	10	
2FDRL 041 410 S06	4.1	16.4	41	100	6		2FDRL 095 760 S10	9.5	38	76	130	10	
2FDRL 042 420 S06	4.2	16.8	42	100	6		2FDRL 096 768 S10	9.6	38.4	76.8	130	10	
2FDRL 043 430 S06	4.3	17.2	43	100	6		2FDRL 097 776 S10	9.7	38.8	77.6	130	10	
2FDRL 044 440 S06	4.4	17.6	44	100	6		2FDRL 098 784 S10	9.8	39.2	78.4	130	10	
2FDRL 045 450 S06	4.5	18	45	100	6		2FDRL 099 792 S10	9.9	39.6	79.2	130	10	
2FDRL 046 460 S06	4.6	18.4	46	100	6		2FDRL 100 800 S10	10	40	80	130	10	
2FDRL 047 470 S06	4.7	18.8	47	100	6		2FDRL 101 808 S12	10.1	40.4	80.8	150	12	
2FDRL 048 480 S06	4.8	19.2	48	100	6		2FDRL 102 816 S12	10.2	40.8	81.6	150	12	
2FDRL 049 490 S06	4.9	19.6	49	100	6		2FDRL 103 824 S12	10.3	41.2	82.4	150	12	
2FDRL 050 500 S06	5	20	50	100	6		2FDRL 104 832 S12	10.4	41.6	83.2	150	12	
2FDRL 051 510 S06	5.1	20.4	51	110	6		2FDRL 105 840 S12	10.5	42	84	150	12	
2FDRL 052 520 S06	5.2	20.8	52	110	6		2FDRL 106 848 S12	10.6	42.4	84.8	150	12	
2FDRL 053 530 S06	5.3	21.2	53	110	6		2FDRL 107 856 S12	10.7	42.8	85.6	150	12	
2FDRL 054 540 S06	5.4	21.6	54	110	6		2FDRL 108 864 S12	10.8	43.2	86.4	150	12	
2FDRL 055 550 S06	5.5	22	55	110	6		2FDRL 109 872 S12	10.9	43.6	87.2	150	12	
2FDRL 056 560 S06	5.6	22.4	56	110	6		2FDRL 110 880 S12	11	44	88	150	12	
2FDRL 057 570 S06	5.7	22.8	57	110	6		2FDRL 111 888 S12	11.1	44.4	88.8	150	12	
2FDRL 058 580 S06	5.8	23.2	58	110	6		2FDRL 112 896 S12	11.2	44.8	89.6	150	12	
2FDRL 059 590 S06	5.9	23.6	59	110	6		2FDRL 113 904 S12	11.3	45.2	90.4	150	12	
2FDRL 060 480 S06	6	24	48	110	6		2FDRL 114 912 S12	11.4	45.6	91.2	150	12	
2FDRL 061 488 S08	6.1	24.4	48.8	120	8		2FDRL 115 920 S12	11.5	46	92	150	12	
2FDRL 062 496 S08	6.2	24.8	49.6	120	8		2FDRL 116 928 S12	11.6	46.4	92.8	150	12	
2FDRL 063 504 S08	6.3	25.2	50.4	120	8		2FDRL 117 936 S12	11.7	46.8	93.6	150	12	
2FDRL 064 512 S08	6.4	25.6	51.2	120	8		2FDRL 118 944 S12	11.8	47.2	94.4	150	12	
2FDRL 065 520 S08	6.5	26	52	120	8		2FDRL 119 952 S12	11.9	47.6	95.2	150	12	
2FDRL 066 528 S08	6.6	26.4	52.8	120	8		2FDRL 120 960 S12	12	48	96	150	12	
2FDRL 067 536 S08	6.7	26.8	53.6	120	8		2FDRL 125 1000 S14	12.5	50	100	180	14	
2FDRL 068 544 S08	6.8	27.2	54.4	120	8		2FDRL 130 1040 S14	13	52	104	180	14	
2FDRL 069 552 S08	6.9	27.6	55.2	120	8		2FDRL 135 1080 S14	13.5	54	108	180	14	
2FDRL 070 560 S08	7	28	56	120	8		2FDRL 140 1120 S14	14	56	112	180	14	
2FDRL 071 568 S08	7.1	28.4	56.8	120	8		2FDRL 145 1160 S16	14.5	58	116	200	16	
2FDRL 072 576 S08	7.2	28.8	57.6	120	8		2FDRL 150 1200 S16	15	60	120	200	16	
2FDRL 073 584 S08	7.3	29.2	58.4	120	8		2FDRL 155 1240 S16	15.5	62	124	200	16	
2FDRL 074 592 S08	7.4	29.6	59.2	120	8		2FDRL 160 1280 S16	16	64	128	200	16	
2FDRL 075 600 S08	7.5	30	60	120	8		2FDRL 165 1320 S18	16.5	66	132	220	18	
2FDRL 076 608 S08	7.6	30.4	60.8	120	8		2FDRL 170 1360 S18	17	68	136	220	18	
2FDRL 077 616 S08	7.7	30.8	61.6	120	8		2FDRL 175 1400 S18	17.5	70	140	220	18	
2FDRL 078 624 S08	7.8	31.2	62.4	120	8		2FDRL 180 1440 S18	18	72	144	220	18	
2FDRL 079 632 S08	7.9	31.6	63.2	120	8		2FDRL 185 1480 S20	18.5	74	148	250	20	
2FDRL 080 640 S08	8	32	64	120	8		2FDRL 190 1520 S20	19	76	152	250	20	
2FDRL 081 648 S10	8.1	32.4	64.8	130	10		2FDRL 195 1560 S20	19.5	78	156	250	20	
2FDRL 082 656 S10	8.2	32.8	65.6	130	10		2FDRL 200 1600 S20	20	80	160	250	20	
2FDRL 083 664 S10	8.3	33.2	66.4	130	10								

# 2FDRW 2 Flutes, Multi-Processing Flat Drills with Coolant hole

## 초경 2날/ 다기능 플랫폼 드릴 (내부 쿨런트)

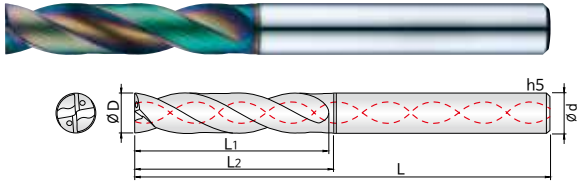

- HRC50이하, 프리하든강, 합금강, 주철 가공용 플랫폼 드릴
  - 더블 마진 옆날과 절삭유 홀을 적용하여, 다양한 경사면과 곡면 드릴가공에 빠른 가공 속도를 실현합니다.
  - 24~30도 헬릭스를 채택하여 칩배출 성능이 매우 우수합니다.
  - 관통 드릴 작업시 버 발생을 최소화 합니다.
  - HR 코팅으로 내열성과 내마모성이 우수, 긴 공구수명을 실현 하였습니다.
- Flat drills for materials up to HRC50, pre-hardened steels, alloy steels, cast irons
  - With double margin of side flute and coolant hole, high speed drilling is available to a variety of inclined and curved surfaces.
  - Chip emission is great and stable drilling is available with between 24 to 30 degree helix design.
  - Minimize burrs during penetration drilling.
  - Increased tool life by applying HR coating with great heat and wear resistance.



518P

단위 : mm

Order Number	날경 Diameter D	홀길이 Flute Length L1	유효장 Effective Length L2	전장 Overall Length L	샹크 Dia d	비고	Order Number	날경 Diameter D	홀길이 Flute Length L1	유효장 Effective Length L2	전장 Overall Length L	샹크 Dia d	비고
New 2FDRW 010 060 S03	1	4.5	6	40	3		2FDRW 060 300 S06	6	27	30	70	6	
New 2FDRW 011 061 S03	1.1	5	6.1	40	3		2FDRW 061 305 S08	6.1	27.5	30.5	80	8	
New 2FDRW 012 066 S03	1.2	5.4	6.6	40	3		2FDRW 062 309 S08	6.2	27.9	30.9	80	8	
New 2FDRW 013 072 S03	1.3	5.9	7.2	40	3		2FDRW 063 314 S08	6.3	28.4	31.4	80	8	
New 2FDRW 014 077 S03	1.4	6.3	7.7	40	3		2FDRW 064 318 S08	6.4	28.8	31.8	80	8	
New 2FDRW 015 081 S03	1.5	6.8	8.1	50	3		2FDRW 065 323 S08	6.5	29.3	32.3	80	8	
New 2FDRW 016 087 S03	1.6	7.2	8.7	50	3		2FDRW 066 327 S08	6.6	29.7	32.7	80	8	
New 2FDRW 017 092 S03	1.7	7.7	9.2	50	3		2FDRW 067 332 S08	6.7	30.2	33.2	80	8	
New 2FDRW 018 098 S03	1.8	8.1	9.8	50	3		2FDRW 068 336 S08	6.8	30.6	33.6	80	8	
New 2FDRW 019 103 S03	1.9	8.6	10.3	50	3		2FDRW 069 341 S08	6.9	31.1	34.1	80	8	
New 2FDRW 020 106 S04	2	9	10.6	50	4		2FDRW 070 345 S08	7	31.5	34.5	80	8	
New 2FDRW 021 112 S04	2.1	9.5	11.2	50	4		2FDRW 071 350 S08	7.1	32	35	80	8	
New 2FDRW 022 117 S04	2.2	10	11.7	50	4		2FDRW 072 354 S08	7.2	32.4	35.4	80	8	
New 2FDRW 023 122 S04	2.3	10.4	12.2	50	4		2FDRW 073 359 S08	7.3	32.9	35.9	80	8	
New 2FDRW 024 128 S04	2.4	10.8	12.8	50	4		2FDRW 074 363 S08	7.4	33.3	36.3	80	8	
New 2FDRW 025 130 S04	2.5	11.3	13	50	4		2FDRW 075 368 S08	7.5	33.8	36.8	80	8	
New 2FDRW 026 136 S04	2.6	11.7	13.6	50	4		2FDRW 076 372 S08	7.6	34.2	37.2	80	8	
New 2FDRW 027 141 S04	2.7	12.2	14.1	50	4		2FDRW 077 377 S08	7.7	34.7	37.7	80	8	
New 2FDRW 028 146 S04	2.8	12.6	14.6	50	4		2FDRW 078 381 S08	7.8	35.1	38.1	80	8	
New 2FDRW 029 151 S04	2.9	13.1	15.1	50	4		2FDRW 079 386 S08	7.9	35.6	38.6	80	8	
2FDRW 030 165 S04	3	13.5	16.5	60	4		2FDRW 080 390 S08	8	36	39	80	8	
2FDRW 031 170 S04	3.1	14	17	60	4		2FDRW 081 395 S10	8.1	36.5	39.5	90	10	
2FDRW 032 174 S04	3.2	14.4	17.4	60	4		2FDRW 082 399 S10	8.2	36.9	39.9	90	10	
2FDRW 033 179 S04	3.3	14.9	17.9	60	4		2FDRW 083 404 S10	8.3	37.4	40.4	90	10	
2FDRW 034 183 S04	3.4	15.3	18.3	60	4		2FDRW 084 408 S10	8.4	37.8	40.8	90	10	
2FDRW 035 188 S04	3.5	15.8	18.8	60	4		2FDRW 085 413 S10	8.5	38.3	41.3	90	10	
2FDRW 036 192 S04	3.6	16.2	19.2	60	4		2FDRW 086 417 S10	8.6	38.7	41.7	90	10	
2FDRW 037 197 S04	3.7	16.7	19.7	60	4		2FDRW 087 422 S10	8.7	39.2	42.2	90	10	
2FDRW 038 201 S04	3.8	17.1	20.1	60	4		2FDRW 088 426 S10	8.8	39.6	42.6	90	10	
2FDRW 039 206 S04	3.9	17.6	20.6	60	4		2FDRW 089 431 S10	8.9	40.1	43.1	90	10	
2FDRW 040 210 S06	4	18	21	60	6		2FDRW 090 435 S10	9	40.5	43.5	90	10	
2FDRW 041 215 S06	4.1	18.5	21.5	70	6		2FDRW 091 440 S10	9.1	41	44	90	10	
2FDRW 042 219 S06	4.2	18.9	21.9	70	6		2FDRW 092 444 S10	9.2	41.4	44.4	90	10	
2FDRW 043 224 S06	4.3	19.4	22.4	70	6		2FDRW 093 449 S10	9.3	41.9	44.9	90	10	
2FDRW 044 228 S06	4.4	19.8	22.8	70	6		2FDRW 094 453 S10	9.4	42.3	45.3	90	10	
2FDRW 045 233 S06	4.5	20.3	22.3	70	6		2FDRW 095 458 S10	9.5	42.8	45.8	90	10	
2FDRW 046 237 S06	4.6	20.7	23.7	70	6		2FDRW 096 462 S10	9.6	43.2	46.2	90	10	
2FDRW 047 242 S06	4.7	21.2	24.2	70	6		2FDRW 097 467 S10	9.7	43.7	46.7	90	10	
2FDRW 048 246 S06	4.8	21.6	24.6	70	6		2FDRW 098 471 S10	9.8	44.1	47.1	90	10	
2FDRW 049 251 S06	4.9	22.1	25.1	70	6		2FDRW 099 476 S10	9.9	44.6	47.6	90	10	
2FDRW 050 255 S06	5	22.5	25.5	70	6		2FDRW 100 480 S10	10	45	48	90	10	
2FDRW 051 260 S06	5.1	23	26	70	6		2FDRW 101 485 S12	10.1	45.5	48.5	100	12	
2FDRW 052 264 S06	5.2	23.4	26.4	70	6		2FDRW 102 489 S12	10.2	45.9	48.9	100	12	
2FDRW 053 269 S06	5.3	23.9	26.9	70	6		2FDRW 103 494 S12	10.3	46.4	49.4	100	12	
2FDRW 054 273 S06	5.4	24.3	27.3	70	6		2FDRW 104 498 S12	10.4	46.8	49.8	100	12	
2FDRW 055 278 S06	5.5	24.8	27.8	70	6		2FDRW 105 503 S12	10.5	47.3	50.3	100	12	
2FDRW 056 282 S06	5.6	25.2	28.2	70	6		2FDRW 106 507 S12	10.6	47.7	50.7	100	12	
2FDRW 057 287 S06	5.7	25.7	28.7	70	6		2FDRW 107 512 S12	10.7	48.2	51.2	100	12	
2FDRW 058 291 S06	5.8	26.1	29.1	70	6		2FDRW 108 516 S12	10.8	48.6	51.6	100	12	
2FDRW 059 296 S06	5.9	26.6	29.6	70	6		2FDRW 109 521 S12	10.9	49.1	52.1	100	12	

DRILL



단위 : mm

Order Number	날경 Diameter D	홈길이 Flute Length L1	유효장 Effective Length L2	전장 Overall Length L	생크 Shank Dia d	비고	Order Number	날경 Diameter D	홈길이 Flute Length L1	유효장 Effective Length L2	전장 Overall Length L	생크 Shank Dia d	비고
2FDRW 110 525 S12	11	49.5	52.5	100	12								
2FDRW 111 530 S12	11.1	50	53	110	12								
2FDRW 112 534 S12	11.2	50.4	53.4	110	12								
2FDRW 113 539 S12	11.3	50.9	53.9	110	12								
2FDRW 114 543 S12	11.4	51.3	54.3	110	12								
2FDRW 115 548 S12	11.5	51.8	54.8	110	12								
2FDRW 116 552 S12	11.6	52.2	55.2	110	12								
2FDRW 117 557 S12	11.7	52.7	55.7	110	12								
2FDRW 118 561 S12	11.8	53.1	56.1	110	12								
2FDRW 119 566 S12	11.9	53.6	56.6	110	12								
2FDRW 120 570 S12	12	54	57	110	12								
2FDRW 125 593 S14	12.5	56.3	59.3	120	14								
2FDRW 130 615 S14	13	58.5	63.5	120	14								
2FDRW 135 638 S14	13.5	60.8	63.8	120	14								
2FDRW 140 660 S14	14	63	66	120	14								
2FDRW 145 683 S16	14.5	65.3	68.3	130	16								
2FDRW 150 705 S16	15	67.5	70.5	130	16								
2FDRW 155 728 S16	15.5	69.8	72.8	130	16								
2FDRW 160 750 S16	16	72	75	130	16								

DRILL

# 2FDRLW

2 Flutes, Long Length Multi-Processing Flat Drills with Coolant hole

## 초경 2날/긴 길이 다기능 플랫 드릴 (내부 콜러트)

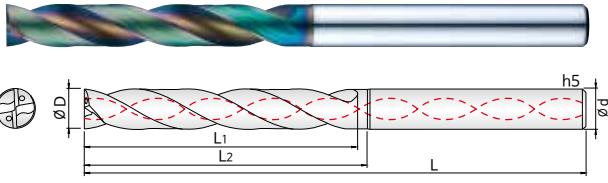

- HRC50이하, 프리하든강, 합금강, 주철 가공용 플랫 드릴
- 더블 마진 옆날과 절삭유 홀을 적용하여, 다양한 경사면과 곡면 드릴가공에 빠른 가공 속도를 실현합니다.
- 24~30도 헬릭스를 채택하여 칩배출 성능이 매우 우수합니다.
- 관통 드릴 작업시 버 발생을 최소화 합니다.
- HR 코팅으로 내열성과 내마모성이 우수, 긴 공구수명을 실현 하였습니다.
- Flat drills for materials up to HRC50, pre-hardened steels, alloy steels, cast irons
- With double margin of side flute and coolant hole, high speed drilling is available to a variety of inclined and curved surfaces.
- Chip emission is great and stable drilling is available with between 24 to 30 degree helix design.
- Minimize burrs during penetration drilling.
- Increased tool life by applying HR coating with great heat and wear resistance.



518P

단위 : mm

Order Number	날경 Diameter D	홀길이 Flute Length L1	유효장 Effective Length L2	전장 Overall Length L	샙크 Shank Dia d	비고	Order Number	날경 Diameter D	홀길이 Flute Length L1	유효장 Effective Length L2	전장 Overall Length L	샙크 Shank Dia d	비고
2FDRLW 030 231 S04	3	20.1	23.1	70	4		2FDRLW 080 566 S08	8	53.6	56.6	100	8	
2FDRLW 031 238 S04	3.1	20.8	23.8	70	4		2FDRLW 081 573 S10	8.1	54.3	57.3	110	10	
2FDRLW 032 244 S04	3.2	21.4	24.4	70	4		2FDRLW 082 579 S10	8.2	54.9	57.9	110	10	
2FDRLW 033 251 S04	3.3	22.1	25.1	70	4		2FDRLW 083 586 S10	8.3	55.6	58.6	110	10	
2FDRLW 034 258 S04	3.4	22.8	25.8	70	4		2FDRLW 084 593 S10	8.4	56.3	59.3	110	10	
2FDRLW 035 265 S04	3.5	23.5	26.5	70	4		2FDRLW 085 600 S10	8.5	57	60	110	10	
2FDRLW 036 271 S04	3.6	24.1	27.1	70	4		2FDRLW 086 606 S10	8.6	57.6	60.6	110	10	
2FDRLW 037 278 S04	3.7	24.8	27.8	70	4		2FDRLW 087 613 S10	8.7	58.3	61.3	110	10	
2FDRLW 038 285 S04	3.8	25.5	28.5	70	4		2FDRLW 088 620 S10	8.8	59	62	110	10	
2FDRLW 039 291 S04	3.9	26.1	29.1	70	4		2FDRLW 089 626 S10	8.9	59.6	62.6	110	10	
2FDRLW 040 298 S06	4	26.8	29.8	70	6		2FDRLW 090 633 S10	9	60.3	63.3	110	10	
2FDRLW 041 305 S06	4.1	27.5	30.5	85	6		2FDRLW 091 640 S10	9.1	61	64	110	10	
2FDRLW 042 311 S06	4.2	28.1	31.1	85	6		2FDRLW 092 646 S10	9.2	61.6	64.6	110	10	
2FDRLW 043 318 S06	4.3	28.8	31.8	85	6		2FDRLW 093 653 S10	9.3	62.3	65.3	110	10	
2FDRLW 044 325 S06	4.4	29.5	32.5	85	6		2FDRLW 094 660 S10	9.4	63	66	110	10	
2FDRLW 045 332 S06	4.5	30.2	33.2	85	6		2FDRLW 095 667 S10	9.5	63.7	66.7	110	10	
2FDRLW 046 338 S06	4.6	30.8	33.8	85	6		2FDRLW 096 673 S10	9.6	64.3	67.3	110	10	
2FDRLW 047 345 S06	4.7	31.5	34.5	85	6		2FDRLW 097 680 S10	9.7	65	68	110	10	
2FDRLW 048 352 S06	4.8	32.2	35.2	85	6		2FDRLW 098 687 S10	9.8	65.7	68.7	110	10	
2FDRLW 049 358 S06	4.9	32.8	35.8	85	6		2FDRLW 099 693 S10	9.9	66.3	69.3	110	10	
2FDRLW 050 365 S06	5	33.5	36.5	85	6		2FDRLW 100 700 S10	10	67	70	110	10	
2FDRLW 051 372 S06	5.1	34.2	37.2	85	6		2FDRLW 101 707 S12	10.1	67.7	70.7	125	12	
2FDRLW 052 378 S06	5.2	34.8	37.8	85	6		2FDRLW 102 713 S12	10.2	68.3	71.3	125	12	
2FDRLW 053 385 S06	5.3	35.5	38.5	85	6		2FDRLW 103 720 S12	10.3	69	72	125	12	
2FDRLW 054 392 S06	5.4	36.2	39.2	85	6		2FDRLW 104 727 S12	10.4	69.7	72.7	125	12	
2FDRLW 055 399 S06	5.5	36.9	39.9	85	6		2FDRLW 105 734 S12	10.5	70.4	73.4	125	12	
2FDRLW 056 405 S06	5.6	37.5	40.5	85	6		2FDRLW 106 740 S12	10.6	71	74	125	12	
2FDRLW 057 412 S06	5.7	38.2	41.2	85	6		2FDRLW 107 747 S12	10.7	71.7	74.7	125	12	
2FDRLW 058 419 S06	5.8	38.9	41.9	85	6		2FDRLW 108 754 S12	10.8	72.4	75.4	125	12	
2FDRLW 059 425 S06	5.9	39.5	42.5	85	6		2FDRLW 109 760 S12	10.9	73	76	125	12	
2FDRLW 060 432 S06	6	40.2	43.2	85	6		2FDRLW 110 767 S12	11	73.7	76.7	125	12	
2FDRLW 061 439 S08	6.1	40.9	43.9	100	8		2FDRLW 111 774 S12	11.1	74.4	77.4	135	12	
2FDRLW 062 445 S08	6.2	41.5	44.5	100	8		2FDRLW 112 780 S12	11.2	75	78	135	12	
2FDRLW 063 452 S08	6.3	42.2	45.2	100	8		2FDRLW 113 787 S12	11.3	75.7	78.7	135	12	
2FDRLW 064 459 S08	6.4	42.9	45.9	100	8		2FDRLW 114 794 S12	11.4	76.4	79.4	135	12	
2FDRLW 065 466 S08	6.5	43.6	46.6	100	8		2FDRLW 115 801 S12	11.5	77.1	80.1	135	12	
2FDRLW 066 472 S08	6.6	44.2	47.2	100	8		2FDRLW 116 807 S12	11.6	77.7	80.7	135	12	
2FDRLW 067 479 S08	6.7	44.9	47.9	100	8		2FDRLW 117 814 S12	11.7	78.4	81.4	135	12	
2FDRLW 068 486 S08	6.8	45.6	48.6	100	8		2FDRLW 118 821 S12	11.8	79.1	82.1	135	12	
2FDRLW 069 492 S08	6.9	46.2	49.2	100	8		2FDRLW 119 827 S12	11.9	79.7	82.7	135	12	
2FDRLW 070 499 S08	7	46.9	49.9	100	8		2FDRLW 120 834 S12	12	80.4	83.4	135	12	
2FDRLW 071 506 S08	7.1	47.6	50.6	100	8		2FDRLW 125 868 S14	12.5	83.8	86.8	140	14	
2FDRLW 072 512 S08	7.2	48.2	51.2	100	8		2FDRLW 130 901 S14	13	87.1	90.1	140	14	
2FDRLW 073 519 S08	7.3	48.9	51.9	100	8		2FDRLW 135 935 S14	13.5	90.5	93.5	140	14	
2FDRLW 074 526 S08	7.4	49.6	52.6	100	8		2FDRLW 140 968 S14	14	93.8	96.8	140	14	
2FDRLW 075 533 S08	7.5	50.3	53.3	100	8		2FDRLW 145 1002 S16	14.5	97.2	100.2	160	16	
2FDRLW 076 539 S08	7.6	50.9	53.9	100	8		2FDRLW 150 1035 S16	15	100.5	103.5	160	16	
2FDRLW 077 546 S08	7.7	51.6	54.6	100	8		2FDRLW 155 1069 S16	15.5	103.9	106.9	160	16	
2FDRLW 078 553 S08	7.8	52.3	55.3	100	8		2FDRLW 160 1102 S16	16	107.2	110.2	160	16	
2FDRLW 079 559 S08	7.9	52.9	55.9	100	8								



4날 범용 다기능 쓰레드밀(역회전)

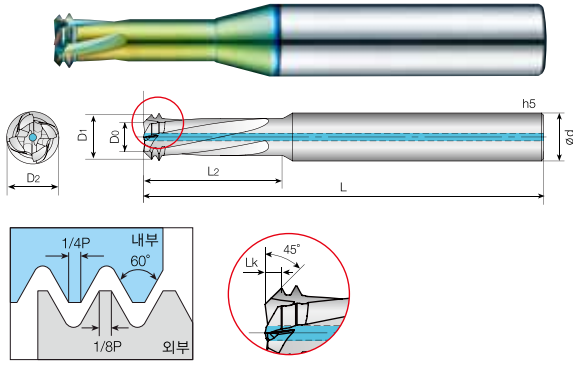

- HRc 40이하의 고경도강, 프리하든강, 합금강, 탄소강, 주철가공
- 4ETM 공구는 하나의 공구로 드릴, 나사 및 챔퍼 작업을 모두 수행합니다.
- 탭 가공을 위한 기초출 작업은 더 이상 필요하지 않습니다.
- 다기능 공구로 막힌구멍, 관통구멍, 경사진 곡면에서도 사용이 가능합니다.
- 원활한 칩 배출을 위해 2D이상의 기초출이 없는 경우 내부 급유형을 추천 합니다.
- 헬리코일 나사 가공이 가능합니다.
- 공구의 주축회전은 역방향(M4)이고, 진행방향은 정 방향으로 진행 됩니다.

• Thread mills for Hardened steels (up to HRc 40), pre-hardened steels, alloy steels, carbon steels, cast irons

- With one 4ETM tool, it's available for drilling, threading and chamfering all together.
- Pre-drilling for tapping is no longer needed.
- It can also be used on blocked holes, penetrating holes, and sloping curved surfaces as multi-function tool.
- If the diameter of hole is longer than 2D without pre-drilled hole, use the tool with coolant for the better chip emission.
- It can be used for heli coil threading.
- The main direction of tool rotation is left-handed (M4) and the direction of threading is right-handed.



519P

ISO 측정항목

단위 Unit: mm

Order Number	피치규격		날수 Flutes Z	산수 Teeth Zt	날경 Diameter			유효장 Effective Length L2	길이 Lk	전장 Overall Length L	샙크 Shank Dia d
	Thread	Pitch			D0	D1	D2				
<b>외부급유형 (Without coolant)</b>											
4ETM 024 070 S06 M3	M3	0.5	4	2	1.37	2.17	2.4	7	0.4	60	6
4ETM 024 085 S06 M3	M3	0.5	4	2	1.37	2.17	2.4	8.5	0.4	60	6
4ETM 032 092 S06 M4	M4	0.7	4	2	1.74	2.88	3.2	9.2	0.57	60	6
4ETM 032 112 S06 M4	M4	0.7	4	2	1.74	2.88	3.2	11.2	0.57	60	6
4ETM 039 115 S06 M5	M5	0.8	4	2	2.21	3.61	3.9	11.5	0.7	60	6
4ETM 039 144 S06 M5	M5	0.8	4	2	2.21	3.61	3.9	14.4	0.7	60	6
4ETM 047 140 S06 M6	M6 ~ M9	1	4	2	2.82	4.4	4.7	14	0.79	60	6
4ETM 047 170 S06 M6	M6 ~ M9	1	4	2	2.82	4.4	4.7	17	0.79	60	6
4ETM 061 180 S08 M8	M8 ~ M12	1.25	4	2	4	5.8	6.1	18	0.9	65	8
4ETM 061 220 S08 M8	M8 ~ M12	1.25	4	2	4	5.8	6.1	22	0.9	65	8
4ETM 078 230 S08 M10	M10 ~ M15	1.5	4	2	5.16	7.4	7.8	23	1.12	65	8
4ETM 078 280 S08 M10	M10 ~ M15	1.5	4	2	5.16	7.4	7.8	28	1.12	65	8
4ETM 090 260 S10 M12	M12	1.75	4	2	6.2	8.6	9	26	1.2	80	10
4ETM 090 330 S10 M12	M12	1.75	4	2	6.2	8.6	9	33	1.2	80	10
4ETM 118 350 S12 M16	M16 ~ M23	2	4	2	7.4	11.4	11.8	35	2	100	12
4ETM 118 430 S12 M16	M16 ~ M23	2	4	2	7.4	11.4	11.8	43	2	100	12

**내부급유형 (With coolant)**

4ETM 047 140 S06 M6C	M6 ~ M9	1	4	2	2.82	4.4	4.7	14	0.79	60	6
4ETM 047 170 S06 M6C	M6 ~ M9	1	4	2	2.82	4.4	4.7	17	0.79	60	6
4ETM 061 180 S08 M8C	M8 ~ M12	1.25	4	2	4	5.8	6.1	18	0.9	65	8
4ETM 061 220 S08 M8C	M8 ~ M12	1.25	4	2	4	5.8	6.1	22	0.9	65	8
4ETM 078 230 S08 M10C	M10 ~ M15	1.5	4	2	5.16	7.4	7.8	23	1.12	65	8
4ETM 078 280 S08 M10C	M10 ~ M15	1.5	4	2	5.16	7.4	7.8	28	1.12	65	8
4ETM 090 260 S10 M12C	M12	1.75	4	2	6.2	8.6	9	26	1.2	80	10
4ETM 090 330 S10 M12C	M12	1.75	4	2	6.2	8.6	9	33	1.2	80	10
4ETM 118 350 S12 M16C	M16 ~ M23	2	4	2	7.4	11.4	11.8	35	2	100	12
4ETM 118 430 S12 M16C	M16 ~ M23	2	4	2	7.4	11.4	11.8	43	2	100	12

THREAD MILL



American UN

단위 Unit: mm

Order Number	피치규격			날수 Flutes Z	산수 Teeth Zt	날경			유효장 Effective Length L2	길이 Lk	전장 Overall Length L	생크 Shank Dia d
	UNC	UNF	Pitch (TPI)			D0	D1	D2				
<b>외부급유형 (Without coolant)</b>												
4ETM 021 072 S06	No.4, No.5		40	4	2	1	1.76	2.1	7.2	0.38	60	6
4ETM 021 088 S06	No.4, No.5		40	4	2	1	1.76	2.1	8.8	0.38	60	6
4ETM 026 086 S06	No.6, No.8		32	4	2	1.32	2.21	2.6	8.6	0.45	60	6
4ETM 026 105 S06	No.6, No.8		32	4	2	1.32	2.21	2.6	10.5	0.45	60	6
4ETM 030 100 S06	No.8	No.10	32	4	2	1.42	2.62	3	10	0.6	60	6
4ETM 030 122 S06	No.8	No.10	32	4	2	1.42	2.62	3	12.2	0.6	60	6
4ETM 035 114 S06	No.10, No.12		24	4	2	1.58	3.18	3.5	11.4	0.8	60	6
4ETM 048 145 S06	1/4"		20	4	2	2.69	4.29	4.8	14.5	0.8	60	6
4ETM 048 180 S06	1/4"		20	4	2	2.69	4.29	4.8	18	0.8	60	6
4ETM 050 144 S06		1/4"	28	4	2	3.2	4.58	5	14.4	0.69	60	6
4ETM 050 178 S06		1/4"	28	4	2	3.2	4.58	5	17.8	0.69	60	6

**내부급유형 (With coolant)**

4ETM 048 145 S08C	1/4"		20	4	2	2.69	4.29	4.8	14.5	0.8	65	6
4ETM 048 180 S08C	1/4"		20	4	2	2.69	4.29	4.8	18	0.8	65	6
4ETM 050 144 S08C		1/4"	28	4	2	3.2	4.58	5	14.4	0.69	65	8
4ETM 050 178 S08C		1/4"	28	4	2	3.2	4.58	5	17.8	0.69	65	8
4ETM 065 176 S08C		5/16", 3/8"	24	4	2	4.34	6.02	6.5	17.6	0.85	65	8
4ETM 065 218 S08C		5/16", 3/8"	24	4	2	4.34	6.02	6.5	21.8	0.85	65	8
4ETM 067 260 S08C	3/8"		16	4	2	3.98	6.18	6.7	26	1.1	65	8

### 4날 알루미늄 전용 다기능 쓰레드밀 (역회전)

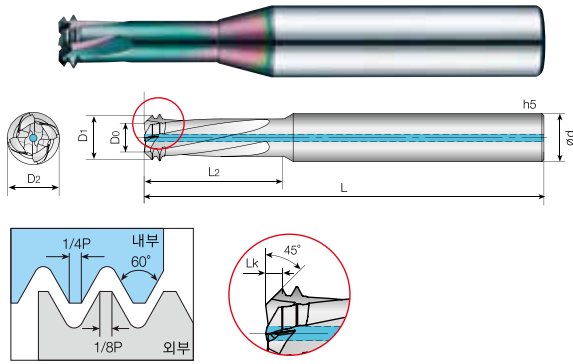

ISO 측정항목

519P

단위 Unit: mm

Order Number	피치규격		날수 Flutes Z	산수 Teeth Zt	날경 Diameter			유효장 Effective Length L2	길이 Lk	전장 Overall Length L	샙크 Shank Dia d
	Thread	Pitch			D0	D1	D2				

#### 외부 급유형 (Without coolant)

4ETMA 0105 033 S04 M014	M1.4	0.3	4	2	0.61	0.95	1.05	3.3	0.17	45	4
4ETMA 0105 040 S04 M014	M1.4	0.3	4	2	0.61	0.95	1.05	4	0.17	45	4
4ETMA 012 037 S04 M016	M1.6~M1.8	0.35	4	2	0.65	1.04	1.2	3.7	0.195	45	4
4ETMA 012 045 S04 M016	M1.6~M1.8	0.35	4	2	0.65	1.04	1.2	4.5	0.195	45	4
4ETMA 0155 045 S04 M2	M2	0.4	4	2	0.94	1.4	1.55	4.5	0.23	45	4
4ETMA 0155 055 S04 M2	M2	0.4	4	2	0.94	1.4	1.55	5.5	0.23	45	4
4ETMA 020 055 S04 M025	M2.5~M2.6	0.45	4	2	1.16	1.85	2	5.5	0.345	45	4
4ETMA 020 0675 S04 M025	M2.5~M2.6	0.45	4	2	1.16	1.85	2	6.75	0.345	45	4
4ETMA 024 070 S06 M3	M3	0.5	4	2	1.37	2.17	2.4	7	0.4	60	6
4ETMA 024 085 S06 M3	M3	0.5	4	2	1.37	2.17	2.4	8.5	0.4	60	6
4ETMA 032 092 S06 M4	M4	0.7	4	2	1.74	2.88	3.2	9.2	0.57	60	6
4ETMA 032 112 S06 M4	M4	0.7	4	2	1.74	2.88	3.2	11.2	0.57	60	6
4ETMA 039 115 S06 M5	M5	0.8	4	2	2.21	3.61	3.9	11.5	0.7	60	6
4ETMA 039 144 S06 M5	M5	0.8	4	2	2.21	3.61	3.9	14.4	0.7	60	6
4ETMA 047 140 S06 M6	M6~M9	1	4	2	2.82	4.4	4.7	14	0.79	60	6
4ETMA 047 170 S06 M6	M6~M9	1	4	2	2.82	4.4	4.7	17	0.79	60	6
4ETMA 061 180 S08 M8	M8~M12	1.25	4	2	4	5.8	6.1	18	0.9	65	8
4ETMA 061 220 S08 M8	M8~M12	1.25	4	2	4	5.8	6.1	22	0.9	65	8
4ETMA 078 230 S08 M10	M10~M15	1.5	4	2	5.16	7.4	7.8	23	1.12	65	8
4ETMA 078 280 S08 M10	M10~M15	1.5	4	2	5.16	7.4	7.8	28	1.12	65	8
4ETMA 090 260 S10 M12	M12	1.75	4	2	6.2	8.6	9	26	1.2	80	10
4ETMA 090 330 S10 M12	M12	1.75	4	2	6.2	8.6	9	33	1.2	80	10
4ETMA 118 350 S12 M16	M16~M23	2	4	2	7.4	11.4	11.8	35	2	100	12
4ETMA 118 430 S12 M16	M16~M23	2	4	2	7.4	11.4	11.8	43	2	100	12

#### 내부 급유형 (With coolant)

4ETMA 047 140 S06 M6C	M6~M9	1	4	2	2.82	4.4	4.7	14	0.79	60	6
4ETMA 047 170 S06 M6C	M6~M9	1	4	2	2.82	4.4	4.7	17	0.79	60	6
4ETMA 061 180 S08 M8C	M8~M12	1.25	4	2	4	5.8	6.1	18	0.9	65	8
4ETMA 061 220 S08 M8C	M8~M12	1.25	4	2	4	5.8	6.1	22	0.9	65	8
4ETMA 078 230 S08 M10C	M10~M15	1.5	4	2	5.16	7.4	7.8	23	1.12	65	8
4ETMA 078 280 S08 M10C	M10~M15	1.5	4	2	5.16	7.4	7.8	28	1.12	65	8
4ETMA 090 260 S10 M12C	M12	1.75	4	2	6.2	8.6	9	26	1.2	80	10
4ETMA 090 330 S10 M12C	M12	1.75	4	2	6.2	8.6	9	33	1.2	80	10
4ETMA 118 350 S12 M16C	M16~M23	2	4	2	7.4	11.4	11.8	35	2	100	12
4ETMA 118 430 S12 M16C	M16~M23	2	4	2	7.4	11.4	11.8	43	2	100	12

THREAD MILL

### American UN

단위 Unit: mm

Order Number	피치규격 Thread			날수 Flutes Z	산수 Teeth Zt	날경 Diameter			유효장 Effective Length L2	길이 Lk	전장 Overall Length L	생크 Shank Dia d
	UNC	UNF	Pitch (TPI)			D0	D1	D2				
<b>외부급유형 (Without coolant)</b>												
4ETMA 021 072 S06	No.4, No.5		40	4	2	1	1.76	2.1	7.2	0.38	60	6
4ETMA 021 088 S06	No.4, No.5		40	4	2	1	1.76	2.1	8.8	0.38	60	6
4ETMA 026 086 S06	No.6, No.8		32	4	2	1.32	2.21	2.6	8.6	0.45	60	6
4ETMA 026 105 S06	No.6, No.8		32	4	2	1.32	2.21	2.6	10.5	0.45	60	6
4ETMA 030 100 S06	No.8	No.10	32	4	2	1.42	2.62	3	10	0.6	60	6
4ETMA 030 122 S06	No.8	No.10	32	4	2	1.42	2.62	3	12.2	0.6	60	6
4ETMA 035 114 S06	No.10, No.12		24	4	2	1.58	3.18	3.5	11.4	0.8	60	6
4ETMA 048 145 S06	1/4"		20	4	2	2.69	4.29	4.8	14.5	0.8	60	6
4ETMA 048 180 S06	1/4"		20	4	2	2.69	4.29	4.8	18	0.8	60	6
4ETMA 050 144 S06		1/4"	28	4	2	3.2	4.58	5	14.4	0.69	60	6
4ETMA 050 178 S06		1/4"	28	4	2	3.2	4.58	5	17.8	0.69	60	6

### 내부급유형 (With coolant)

4ETMA 048 145 S08C	1/4"		20	4	2	2.69	4.29	4.8	14.5	0.8	65	6
4ETMA 048 180 S08C	1/4"		20	4	2	2.69	4.29	4.8	18	0.8	65	6
4ETMA 050 144 S08C		1/4"	28	4	2	3.2	4.58	5	14.4	0.69	65	8
4ETMA 050 178 S08C		1/4"	28	4	2	3.2	4.58	5	17.8	0.69	65	8
4ETMA 065 176 S08C		5/16", 3/8"	24	4	2	4.34	6.02	6.5	17.6	0.85	65	8
4ETMA 065 218 S08C		5/16", 3/8"	24	4	2	4.34	6.02	6.5	21.8	0.85	65	8
4ETMA 067 260 S08C	3/8"		16	4	2	3.98	6.18	6.7	26	1.1	65	8

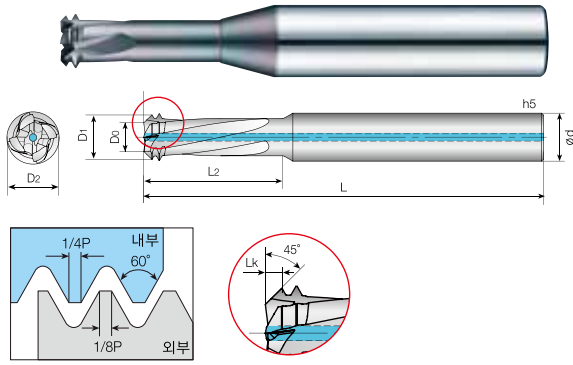

#### SUS, 티타늄 합금 가공

- 4ETMS 공구는 하나의 공구로 드릴, 나사 및 챔퍼 작업을 모두 수행합니다.
- 탭 가공을 위한 기초출 작업은 더 이상 필요하지 않습니다.
- 다기능 공구로 막힌구멍, 관통구멍, 경사진 곡면에서도 사용이 가능합니다.
- 원활한 칩 배출을 위해 2D이상의 기초출이 없는 경우 내부 급유형을 추천 합니다.
- 헬리코일 나사 가공이 가능합니다.
- 공구의 주축회전은 역방향(M4)이고, 진행방향은 정 방향으로 진행 됩니다.

#### Thread Mills for Stainless and Titanium alloys

- With one 4ETM tool, it's available for drilling, threading and chamfering all together.
- Pre-drilling for tapping is no longer needed.
- It can also be used on blocked holes, penetrating holes, and sloping curved surfaces as multi-function tool.
- If the diameter of hole is longer than 2D without pre-drilled hole, use the tool with coolant for the better chip emission.
- It can be used for heli coil threading.
- The main direction of tool rotation is left-handed (M4) and the direction of threading is right-handed.



519P

#### ISO 측정항목

단위 Unit: mm

Order Number	피치규격		날수 Flutes Z	산수 Teeth Zt	날경 Diameter			유효장 Effective Length L2	길이 Lk	전장 Overall Length L	샤희 Shank Dia d
	Thread	Pitch			D0	D1	D2				
4ETMS 024 070 S06 M3	M3	0.5	4	2	1.37	2.17	2.4	7	0.4	60	6
4ETMS 024 085 S06 M3	M3	0.5	4	2	1.37	2.17	2.4	8.5	0.4	60	6
4ETMS 032 092 S06 M4	M4	0.7	4	2	1.74	2.88	3.2	9.2	0.57	60	6
4ETMS 032 112 S06 M4	M4	0.7	4	2	1.74	2.88	3.2	11.2	0.57	60	6
4ETMS 039 115 S06 M5	M5	0.8	4	2	2.21	3.61	3.9	11.5	0.7	60	6
4ETMS 039 144 S06 M5	M5	0.8	4	2	2.21	3.61	3.9	14.4	0.7	60	6
4ETMS 047 140 S06 M6	M6 ~ M9	1	4	2	2.82	4.4	4.7	14	0.79	60	6
4ETMS 047 170 S06 M6	M6 ~ M9	1	4	2	2.82	4.4	4.7	17	0.79	60	6
4ETMS 061 180 S08 M8	M8 ~ M12	1.25	4	2	4	5.8	6.1	18	0.9	65	8
4ETMS 061 220 S08 M8	M8 ~ M12	1.25	4	2	4	5.8	6.1	22	0.9	65	8
4ETMS 078 230 S08 M10	M10 ~ M15	1.5	4	2	5.16	7.4	7.8	23	1.12	65	8
4ETMS 078 280 S08 M10	M10 ~ M15	1.5	4	2	5.16	7.4	7.8	28	1.12	65	8
4ETMS 090 260 S10 M12	M12	1.75	4	2	6.2	8.6	9	26	1.2	80	10
4ETMS 090 330 S10 M12	M12	1.75	4	2	6.2	8.6	9	33	1.2	80	10
4ETMS 118 350 S12 M16	M16 ~ M23	2	4	2	7.4	11.4	11.8	35	2	100	12
4ETMS 118 430 S12 M16	M16 ~ M23	2	4	2	7.4	11.4	11.8	43	2	100	12

#### 외부 급유형 (Without coolant)

#### 내부 급유형 (With coolant)

4ETMS 047 140 S06 M6C	M6~M9	1	4	2	2.82	4.4	4.7	14	0.79	60	6
4ETMS 047 170 S06 M6C	M6~M9	1	4	2	2.82	4.4	4.7	17	0.79	60	6
4ETMS 061 180 S08 M8C	M8~M12	1.25	4	2	4	5.8	6.1	18	0.9	65	8
4ETMS 061 220 S08 M8C	M8~M12	1.25	4	2	4	5.8	6.1	22	0.9	65	8
4ETMS 078 230 S08 M10C	M10~M15	1.5	4	2	5.16	7.4	7.8	23	1.12	65	8
4ETMS 078 280 S08 M10C	M10~M15	1.5	4	2	5.16	7.4	7.8	28	1.12	65	8
4ETMS 090 260 S10 M12C	M12	1.75	4	2	6.2	8.6	9	26	1.2	80	10
4ETMS 090 330 S10 M12C	M12	1.75	4	2	6.2	8.6	9	33	1.2	80	10
4ETMS 118 350 S12 M16C	M16~M23	2	4	2	7.4	11.4	11.8	35	2	100	12
4ETMS 118 430 S12 M16C	M16~M23	2	4	2	7.4	11.4	11.8	43	2	100	12

### American UN

단위 Unit: mm

Order Number	피치규격 Thread			날수 Flutes Z	산수 Teeth Zt	날경 Diameter			유효장 Effective Length L2	길이 Lk	전장 Overall Length L	생크 Shank Dia d
	UNC	UNF	Pitch (TPI)			D0	D1	D2				
<b>외부급유형 (Without coolant)</b>												
4ETMS 021 072 S06	No.4, No.5		40	4	2	1	1.76	2.1	7.2	0.38	60	6
4ETMS 021 088 S06	No.4, No.5		40	4	2	1	1.76	2.1	8.8	0.38	60	6
4ETMS 026 086 S06	No.6, No.8		32	4	2	1.32	2.21	2.6	8.6	0.45	60	6
4ETMS 026 105 S06	No.6, No.8		32	4	2	1.32	2.21	2.6	10.5	0.45	60	6
4ETMS 030 100 S06	No.8	No.10	32	4	2	1.42	2.62	3	10	0.6	60	6
4ETMS 030 122 S06	No.8	No.10	32	4	2	1.42	2.62	3	12.2	0.6	60	6
4ETMS 035 114 S06	No.10, No.12		24	4	2	1.58	3.18	3.5	11.4	0.8	60	6
4ETMS 048 145 S06	1/4"		20	4	2	2.69	4.29	4.8	14.5	0.8	60	6
4ETMS 048 180 S06	1/4"		20	4	2	2.69	4.29	4.8	18	0.8	60	6
4ETMS 050 144 S06		1/4"	28	4	2	3.2	4.58	5	14.4	0.69	60	6
4ETMS 050 178 S06		1/4"	28	4	2	3.2	4.58	5	17.8	0.69	60	6

### 내부급유형 (With coolant)

4ETMS 048 145 S08C	1/4"		20	4	2	2.69	4.29	4.8	14.5	0.8	65	6
4ETMS 048 180 S08C	1/4"		20	4	2	2.69	4.29	4.8	18	0.8	65	6
4ETMS 050 144 S08C		1/4"	28	4	2	3.2	4.58	5	14.4	0.69	65	8
4ETMS 050 178 S08C		1/4"	28	4	2	3.2	4.58	5	17.8	0.69	65	8
4ETMS 065 176 S08C		5/16", 3/8"	24	4	2	4.34	6.02	6.5	17.6	0.85	65	8
4ETMS 065 218 S08C		5/16", 3/8"	24	4	2	4.34	6.02	6.5	21.8	0.85	65	8
4ETMS 067 260 S08C	3/8"		16	4	2	3.98	6.18	6.7	26	1.1	65	8



# 4ETMR Multi-functional Engraving Thread Mills for Multi Purpose (R Rotation)

## 범용 다기능 조각기용 쓰레드밀 (정회전)

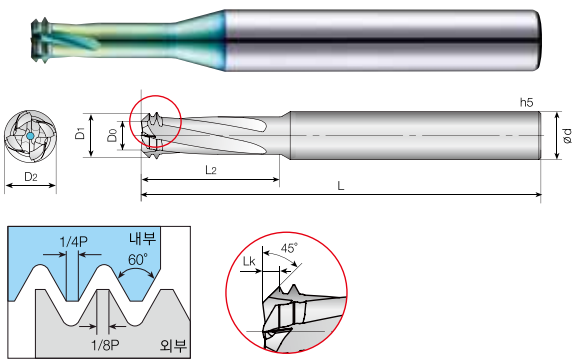

- HRc 40이하의 고경도강, 프리하든강, 합금강, 탄소강, 주철가공
- 4ETMR 공구는 하나의 공구로 드릴, 나사 및 챔퍼 작업 모두 수행합니다.
- 조각기용으로 공구의 주축회전과 진행방향 모두 정 방향(M3)으로 진행 됩니다.
- 탭 가공을 위한 기초 홀 작업은 더 이상 필요하지 않습니다.
- 다기능 공구로 막힌구멍, 관통구멍, 경사진 곡면에서도 사용이 가능합니다.
- 헬리코일 나사 가공이 가능합니다.

- Thread mills for Hardened steels (up to HRc 40), pre-hardened steels, alloy steels, carbon steels, cast irons
- With one 4ETMR tool, it's available for drilling, threading, and chamfering all together.
- For engraving purpose, the main direction of tool rotation and the direction of threading are right-handed (M3).
- Pre-drilling for tapping is no longer needed.
- It can also be used on blocked holes, penetrating holes, and sloping curved surfaces as multi-function tool.
- It can be used for heli coil threading.



ISO 측정항목

519P

단위 Unit: mm

Order Number	피치규격		날수 Flutes Z	산수 Teeth Zt	날경 Diameter			유효장 Effective Length L2	길이 Lk	전장 Overall Length L	샙크 Shank Dia d
	Thread	Pitch			D0	D1	D2				

외부 급유형 (Without coolant)

4ETMR 024 070 S06 M3	M3	0.5	4	2	1.37	2.17	2.4	7	0.4	60	6
4ETMR 032 092 S06 M4	M4	0.7	4	2	1.74	2.88	3.2	9.2	0.57	60	6
4ETMR 039 115 S06 M5	M5	0.8	4	2	2.21	3.61	3.9	11.5	0.7	60	6
4ETMR 047 140 S06 M6	M6 ~ M9	1	4	2	2.82	4.4	4.7	14	0.79	60	6
4ETMR 061 180 S08 M8	M8 ~ M12	1.25	4	2	4	5.8	6.1	18	0.9	65	8
4ETMR 078 230 S08 M10	M10 ~ M15	1.5	4	2	5.16	7.4	7.8	23	1.12	65	8
4ETMR 090 260 S10 M12	M12	1.75	4	2	6.2	8.6	9	26	1.2	80	10
4ETMR 118 350 S12 M16	M16 ~ M23	2	4	2	7.4	11.4	11.8	35	2	100	12

# 4ETMRA

Multi-functional Engraving Thread Mills for Aluminum (R Rotation)

## 알루미늄 전용 다기능 조각기용 쓰레드밀 (정회전)

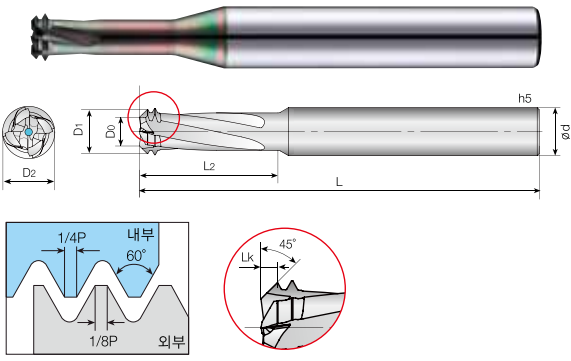

4 UWC 초미립자 RTAC Coating 15° Helix Angle R Rotation CUTTING DATA 519P

ISO 측정항목

단위 Unit: mm

Order Number	피치규격		날수 Flutes Z	산수 Teeth Zt	날경			유효장 Effective Length L2	길이 Lk	전장 Overall Length L	생크 Shank Dia d
	Thread	Pitch			D0	D1	D2				
4ETMRA 0105 033 S04 M014	M1.4	0.3	4	2	0.61	0.95	1.05	3.3	0.17	45	4
4ETMRA 012 037 S04 M016	M1.6~M1.8	0.35	4	2	0.65	1.04	1.2	3.7	0.195	45	4
4ETMRA 0155 045 S04 M2	M2	0.4	4	2	0.94	1.4	1.55	4.5	0.23	45	4
4ETMRA 020 055 S04 M025	M2.5~M2.6	0.45	4	2	1.16	1.85	2	5.5	0.345	45	4
4ETMRA 024 070 S06 M3	M3	0.5	4	2	1.37	2.17	2.4	7	0.4	60	6
4ETMRA 032 092 S06 M4	M4	0.7	4	2	1.74	2.88	3.2	9.2	0.57	60	6
4ETMRA 039 115 S06 M5	M5	0.8	4	2	2.21	3.61	3.9	11.5	0.7	60	6
4ETMRA 047 140 S06 M6	M6 ~ M9	1	4	2	2.82	4.4	4.7	14	0.79	60	6
4ETMRA 061 180 S08 M8	M8 ~ M12	1.25	4	2	4	5.8	6.1	18	0.9	65	8
4ETMRA 078 230 S08 M10	M10 ~ M15	1.5	4	2	5.16	7.4	7.8	23	1.12	65	8
4ETMRA 090 260 S10 M12	M12	1.75	4	2	6.2	8.6	9	26	1.2	80	10
4ETMRA 118 350 S12 M16	M16 ~ M23	2	4	2	7.4	11.4	11.8	35	2	100	12

**외부 급유형 (Without coolant)**

# 4ETMRS Multi-functional Engraving/Router Thread Mills for SUS (R Rotation)

## SUS용 다기능 조각기용 쓰레드밀 (정회전)

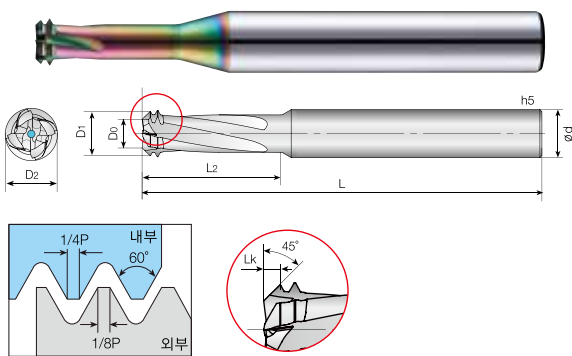

**SUS, 티타늄합금 가공**

- 4ETMRS 공구는 하나의 공구로 드릴, 나사 및 챔퍼 작업 모두 수행합니다.
- 조각기용으로 공구의 주축회전과 진행방향 모두 정 방향(M3)으로 진행 됩니다.
- 탭 가공을 위한 기초 홀 작업은 더 이상 필요하지 않습니다.
- 다기능 공구로 막힌구멍, 관통구멍, 경사진 곡면에서도 사용이 가능합니다.
- 헬리코일 나사 가공이 가능합니다.

**Thread Mills for Stainless and Titanium alloys**

- With one 4ETMRS tool, it's available for drilling, threading, and chamfering all together.
- For engraving purpose, the main direction of tool rotation and the direction of threading are right-handed (M3).
- Pre-drilling for tapping is no longer needed.
- It can also be used on blocked holes, penetrating holes, and sloping curved surfaces as multi-function tool.
- It can be used for heli coil threading.



ISO 측정항목

519P

단위 Unit: mm

Order Number	피치규격		날수 Flutes Z	산수 Teeth Zt	날경 Diameter			유효장 Effective Length L2	길이 Lk	전장 Overall Length L	샹크 Shank Dia d
	Thread	Pitch			D0	D1	D2				
4ETMRS 024 070 S06 M3	M3	0.5	4	2	1.37	2.17	2.4	7	0.4	60	6
4ETMRS 032 092 S06 M4	M4	0.7	4	2	1.74	2.88	3.2	9.2	0.57	60	6
4ETMRS 039 115 S06 M5	M5	0.8	4	2	2.21	3.61	3.9	11.5	0.7	60	6
4ETMRS 047 140 S06 M6	M6 ~ M9	1	4	2	2.82	4.4	4.7	14	0.79	60	6
4ETMRS 061 180 S08 M8	M8 ~ M12	1.25	4	2	4	5.8	6.1	18	0.9	65	8
4ETMRS 078 230 S08 M10	M10 ~ M15	1.5	4	2	5.16	7.4	7.8	23	1.12	65	8
4ETMRS 090 260 S10 M12	M12	1.75	4	2	6.2	8.6	9	26	1.2	80	10
4ETMRS 118 350 S12 M16	M16 ~ M23	2	4	2	7.4	11.4	11.8	35	2	100	12

외부 급유형 (Without coolant)

THREAD MILL

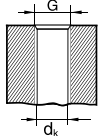
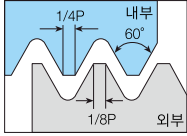
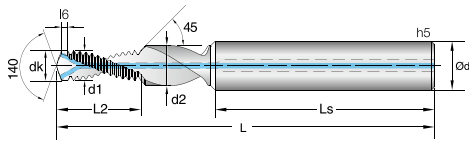

519P

ISO 측정항목

단위 Unit: mm

Order Number		피치규격		드릴직경	외경	목부직경	유효장	생크길이	드릴길이	전장	생크
비코팅 Un coated	코팅 Coated	Thread	Pitch	Drill Dia dk	Cutter Dia d1	Max C sink d2	Effective Length L2	Shank Length Ls	Drill Length L6	Overall Length L	Shank Dia d

외부 급유형 (Without coolant)

2DTM 011 0276 M014	2DTMC 011 0276 M014	M1.4	0.3	1.1	1.05	1.55	2.76	33	0.2	45	4
2DTM 011 0367 M014	2DTMC 011 0367 M014	M1.4	0.3	1.1	1.05	1.55	3.67	33	0.2	45	4
2DTM 0125 032 M016	2DTMC 0125 032 M016	M1.6	0.35	1.25	1.2	1.75	3.2	33	0.25	45	4
2DTM 0125 0425 M016	2DTMC 0125 0425 M016	M1.6	0.35	1.25	1.2	1.75	4.25	33	0.25	45	4
2DTM 0145 0358 M018	2DTMC 0145 0358 M018	M1.8	0.35	1.45	1.4	2	3.58	33	0.25	45	4
2DTM 0145 0463 M018	2DTMC 0145 0463 M018	M1.8	0.35	1.45	1.4	2	4.63	33	0.25	45	4
2DTM 016 0448 M2	2DTMC 016 0448 M2	M2	0.4	1.6	1.55	2.25	4.48	32	0.3	45	4
2DTM 016 0568 M2	2DTMC 016 0568 M2	M2	0.4	1.6	1.55	2.25	5.68	32	0.3	45	4
2DTM 0205 0554 M025	2DTMC 0205 0554 M025	M2.5	0.45	2.05	2	2.85	5.54	30.5	0.35	45	4
2DTM 0205 0689 M025	2DTMC 0205 0689 M025	M2.5	0.45	2.05	2	2.85	6.89	30.5	0.35	45	4
2DTM 0215 0554 M026	2DTMC 0215 0554 M026	M2.6	0.45	2.15	2.1	2.95	5.54	30.5	0.35	45	4
2DTM 0215 0691 M026	2DTMC 0215 0691 M026	M2.6	0.45	2.15	2.1	2.95	6.91	30.5	0.35	45	4
2DTM 025 067 S06 M3	2DTMC 025 067 S06 M3	M3	0.5	2.5	2.45	3.4	6.7	36	0.4	50	6
2DTM 025 082 S06 M3	2DTMC 025 082 S06 M3	M3	0.5	2.5	2.45	3.4	8.2	36	0.4	50	6
2DTM 033 087 S06 M4	2DTMC 033 087 S06 M4	M4	0.7	3.3	3.25	4.5	8.7	36	0.6	50	6
2DTM 033 108 S06 M4	2DTMC 033 108 S06 M4	M4	0.7	3.3	3.25	4.5	10.8	36	0.6	50	6
2DTM 042 109 S06 M5	2DTMC 042 109 S06 M5	M5	0.8	4.2	4	5.5	10.9	36	0.7	55	6
2DTM 042 133 S06 M5	2DTMC 042 133 S06 M5	M5	0.8	4.2	4	5.5	13.3	36	0.7	55	6
2DTM 050 137 S08 M6	2DTMC 050 137 S08 M6	M6	1	5	4.75	6.6	13.7	36	1	60	8
2DTM 050 167 S08 M6	2DTMC 050 167 S08 M6	M6	1	5	4.75	6.6	16.7	36	1	60	8
2DTM 068 184 S10 M8	2DTMC 068 184 S10 M8	M8	1.25	6.8	6.35	9	18.4	40	1.2	75	10
2DTM 068 221 S10 M8	2DTMC 068 221 S10 M8	M8	1.25	6.8	6.35	9	22.1	40	1.2	75	10
2DTM 085 222 S12 M10	2DTMC 085 222 S12 M10	M10	1.5	8.5	7.95	11	22.2	45	1.5	80	12
2DTM 085 267 S12 M10	2DTMC 085 267 S12 M10	M10	1.5	8.5	7.95	11	26.7	45	1.5	80	12
2DTM 102 255 S14 M12	2DTMC 102 255 S14 M12	M12	1.75	10.2	9.95	13.5	25.5	45	1.5	90	14
2DTM 102 308 S14 M12	2DTMC 102 308 S14 M12	M12	1.75	10.2	9.95	13.5	30.8	45	1.5	90	14
2DTM 120 312 S16 M14	2DTMC 120 312 S16 M14	M14	2	12	11.2	15.5	31.2	48	1.5	100	16
2DTM 120 392 S16 M14	2DTMC 120 392 S16 M14	M14	2	12	11.2	15.5	39.2	48	1.5	100	16
2DTM 140 355 S18 M16	2DTMC 140 355 S18 M16	M16	2	14	13.2	17.5	35.5	48	1.5	100	18
2DTM 140 435 S18 M16	2DTMC 140 435 S18 M16	M16	2	14	13.2	17.5	43.5	55.7	1.5	115	18

내부 급유형 (With coolant)

2DTM 042 109 S06 M5C	2DTMC 042 109 S06 M5C	M5	0.8	4.2	4	5.5	10.9	36	0.7	55	6
2DTM 042 133 S06 M5C	2DTMC 042 133 S06 M5C	M5	0.8	4.2	4	5.5	13.3	36	0.7	55	6
2DTM 050 137 S08 M6C	2DTMC 050 137 S08 M6C	M6	1	5	4.75	6.6	13.7	36	1	60	8
2DTM 050 167 S08 M6C	2DTMC 050 167 S08 M6C	M6	1	5	4.75	6.6	16.7	36	1	60	8
2DTM 068 184 S10 M8C	2DTMC 068 184 S10 M8C	M8	1.25	6.8	6.35	9	18.4	40	1.2	75	10
2DTM 068 221 S10 M8C	2DTMC 068 221 S10 M8C	M8	1.25	6.8	6.35	9	22.1	40	1.2	75	10
2DTM 085 222 S12 M10C	2DTMC 085 222 S12 M10C	M10	1.5	8.5	7.95	11	22.2	45	1.5	80	12
2DTM 085 267 S12 M10C	2DTMC 085 267 S12 M10C	M10	1.5	8.5	7.95	11	26.7	45	1.5	80	12
2DTM 102 255 S14 M12C	2DTMC 102 255 S14 M12C	M12	1.75	10.2	9.95	13.5	25.5	45	1.5	90	14
2DTM 102 308 S14 M12C	2DTMC 102 308 S14 M12C	M12	1.75	10.2	9.95	13.5	30.8	45	1.5	90	14
2DTM 120 312 S16 M14C	2DTMC 120 312 S16 M14C	M14	2	12	11.2	15.5	31.2	48	1.5	100	16
2DTM 120 392 S16 M14C	2DTMC 120 392 S16 M14C	M14	2	12	11.2	15.5	39.2	48	1.5	100	16
2DTM 140 355 S18 M16C	2DTMC 140 355 S18 M16C	M16	2	14	13.2	17.5	35.5	48	1.5	100	18
2DTM 140 435 S18 M16C	2DTMC 140 435 S18 M16C	M16	2	14	13.2	17.5	43.5	55.7	1.5	115	18

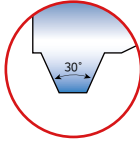
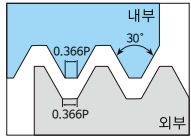
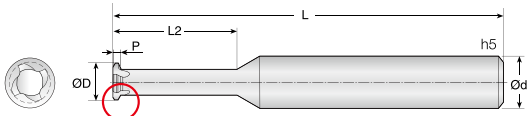

나사산 확대



519P

ISO 측정항목

단위 Unit: mm

Order Number	나사가능규격 Thread	피치규격 Pitch	날수 Flutes Z	산수 Teeth Zt	날경 Diameter D1	유효장 Effective Length L2	전장 Overall Length L	샙크 Shank Dia d
--------------	------------------	---------------	-------------------	-------------------	----------------------	----------------------------------	------------------------------	----------------------

외부급유형 (Without coolant)

4TRTM 055 135 S06	Tr8, Tr9	1.5	4	1	5.5	13.5	60	6
4TRTM 066 210 S08	Tr10, Tr11	2	4	1	6.6	21	65	8
4TRTM 070 250 S08	Tr12	3	4	1	7	25	65	8
4TRTM 086 250 S10	Tr12, Tr14	2	4	1	8.6	25	75	10
4TRTM 089 290 S10	Tr14, Tr22	3	4	1	8.9	29	75	10
4TRTM 092 330 S10	Tr16, Tr18, Tr20	4	4	1	9.2	33	75	10
4TRTM 135 450 S14	Tr22, Tr24, Tr26	5	4	1	13.5	45	105	14

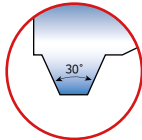
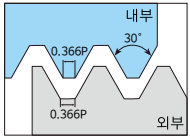
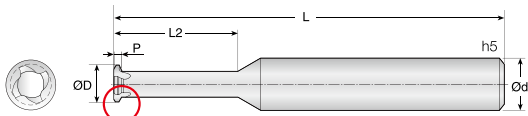

나사산 확대

### SUS, 티타늄합금 가공

- 동력 전달용 미터계 30° 사다리꼴 나사 가공 전용
- 소구경 크기의 깊은홀의 나사가공에 사용할 수 있습니다.
- 프로파일에 따라 나사산 깊이는 최대가 될 수 있습니다.
- 하나의 나사산으로 구성되어 다양한 PITCH의 나사 가공이 가능합니다.
- 다양한 피삭재의 하나의 나사산으로 여러번의 절삭이 가능하여 안정적입니다.

### Thread mills for SUS and Titanium alloys

- For power transmission meter 30° trapezoidal thread milling.
- It can be used for threading deep holes the size of a small diameter.
- Depending on the profile, thread depth can be maximum
- Composed of a single thread, it performs various pitch thread milling.
- Available for multiple milling of various materials with one thread ensuring stability



ISO 측정항목

519P

단위 Unit: mm

Order Number	나사가능규격 Thread	피치규격 Pitch	날수 Flutes Z	산수 Teeth Zt	날경 Diameter D1	유효장 Effective Length L2	전장 Overall Length L	샤홙크 Shank Dia d
4TRTMS 055 135 S06	Tr8, Tr9	1.5	4	1	5.5	13.5	60	6
4TRTMS 066 210 S08	Tr10, Tr11	2	4	1	6.6	21	65	8
4TRTMS 070 250 S08	Tr12	3	4	1	7	25	65	8
4TRTMS 086 250 S10	Tr12, Tr14	2	4	1	8.6	25	75	10
4TRTMS 089 290 S10	Tr14, Tr22	3	4	1	8.9	29	75	10
4TRTMS 092 330 S10	Tr16, Tr18, Tr20	4	4	1	9.2	33	75	10
4TRTMS 135 450 S14	Tr22, Tr24, Tr26	5	4	1	13.5	45	105	14

외부급유형 (Without coolant)

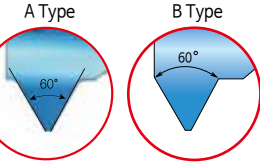
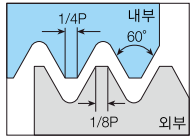
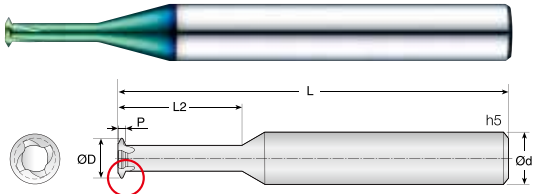

나사산 확대

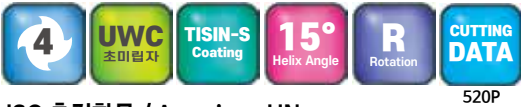

520P

ISO 측정항목 / American UN

단위 Unit: mm

Order Number	미터나사 (Metric screw)		유니파이 나사 (Unified screw)			날수 (Flutes) Z	타입 (Type)	날경 (Diameter) D	유효장 (Effective Length) L2	전장 (Overall Length) L	샙크 (Shank Dia) d
	일반 나사 (M Coarse)	가는 나사 (M Fine)	UNC	UNF	UNS						
4MTM 0072 036 S03	M1 × 0.25					4	A	0.72	3.6	45	3
4MTM 009 043 S03	M1.2 × 0.25	M1.4 × 0.25 M1.6 × 0.25				4	A	0.9	4.3	45	3
4MTM 0105 050 S03	M1.4 × 0.3					4	A	1.05	5	45	3
4MTM 0115 031 S03	M1.6 × 0.35	M1.6 × 0.25 M1.8 × 0.25 M2 × 0.25		0-80		4	B	1.15	3.1	45	3
4MTM 012 057 S03	M1.6 × 0.35	M2 × 0.35 M2.2 × 0.35				4	A	1.2	5.7	45	3
4MTM 014 037 S03	M2 × 0.4 M2.2 × 0.45	M2 × 0.35 M2.2 × 0.35	1-64 2-56	1-72 2-64		4	B	1.4	3.7	45	3
4MTM 0155 071 S03	M2 × 0.4					4	A	1.55	7.1	45	3
4MTM 019 052 S03	M2.5 × 0.45	M2.5 × 0.35 M3 × 0.35	3-48 4-40	3-56 4-48		4	B	1.9	5.2	45	3
4MTM 020 090 S03	M2.5 × 0.45	M2.6 × 0.45				4	A	2	9	45	3
4MTM 0237 0106 S03	M3 × 0.5	M3.5 × 0.5 M4 × 0.5				4	A	2.37	10.6	45	3
4MTM 0245 070 S03	M3 × 0.5 M3.5 × 0.6	M3.5 × 0.5	5-40 6-32	5-44 6-40		4	B	2.45	7	45	3
4MTM 032 095 S06	M4 × 0.7 M4.5 × 0.75	M4 × 0.5	8-32 10-24	8-36 10-32	10-28	4	B	3.2	9.5	60	6
4MTM 040 125 S06	M5 × 0.8 M6 × 1	M5 × 0.5 M5.5 × 0.5 M5 × 0.75	12-24	12-28	10-36 10-40 10-48	4	B	4	12.5	60	6
4MTM 065 166 S08	M8 × 1.25	M10 × 1.25 M12 × 1.25 M14 × 1.25				4	B	6.5	16.6	60	8
4MTM 082 208 S10	M10 × 1.5	M12 × 1.5 M14 × 1.5 M16 × 1.5				4	B	8.2	20.8	70	10
4MTM 099 250 S10	M12 × 1.75	M14 × 1.75 M16 × 1.75 M18 × 1.75				4	B	9.9	25	70	10

외부 급유형 (Without coolant)

## 4날 알루미늄 전용 다기능 쓰레드밀 (1나사산)

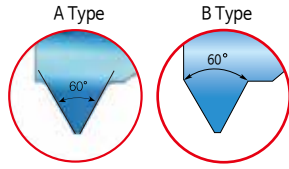
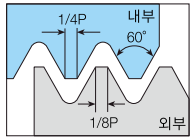
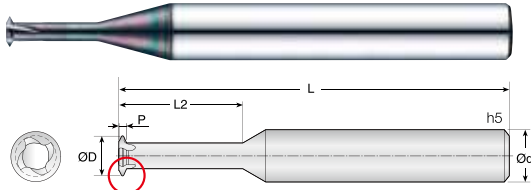

나사산 확대

- 알루미늄, 알루미늄 합금 등 비철 비금속 가공
- 60° 미터나사 / 관용나사 / 유니파이 나사가공 전용
- 소구경 크기의 깊은홀의 나사가공에 사용할 수 있습니다.
- 프로파일에 따라 나사산 깊이는 최대가 될 수 있습니다.
- 하나의 나사산으로 구성되어 다양한 PITCH와 테이퍼 나사가공이 가능합니다.
- 오른나사와 왼나사 작업이 모두 가능합니다.
- 헬리코일 나사 가공이 가능합니다.

### Thread mills for aluminum, aluminum alloys, non-ferrous and non-metallic materials.

- Specifically designed for 60° metric threads, NPT threads, and UN threads.
- Suitable for threading deep holes with small diameters.
- Maximum thread depth can be achieved based on the profile.
- Configured with a single tap, allowing for various PITCH and taper threading operations.
- Suitable for both right-hand and left-hand threading.
- It can be used for heli coil threading.

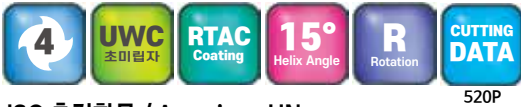

520P

ISO 측정항목 / American UN

단위 Unit: mm

Order Number	미터나사 (Metric screw)		유니파이 나사 (Unified screw)			날수 (Flutes) Z	타입 (Type)	날경 (Diameter) D	유효장 (Effective Length) L2	전장 (Overall Length) L	샙크 (Shank Dia) d
	일반 나사 (M Coarse)	가는 나사 (M Fine)	UNC	UNF	UNS						
4MTMA 0072 036 S03	M1 x 0.25					4	A	0.72	3.6	45	3
4MTMA 009 043 S03	M1.2 x 0.25	M1.4 x 0.25 M1.6 x 0.25				4	A	0.9	4.3	45	3
4MTMA 0105 050 S03	M1.4 x 0.3					4	A	1.05	5	45	3
4MTMA 0115 031 S03	M1.6 x 0.35	M1.6 x 0.25 M1.8 x 0.25 M2 x 0.25			0-80	4	B	1.15	3.1	45	3
4MTMA 012 057 S03	M1.6 x 0.35	M2 x 0.35 M2.2 x 0.35				4	A	1.2	5.7	45	3
4MTMA 014 037 S03	M2 x 0.4	M2 x 0.35	1-64	1-72		4	B	1.4	3.7	45	3
4MTMA 0155 071 S03	M2 x 0.4	M2.2 x 0.35	2-56	2-64		4	A	1.55	7.1	45	3
4MTMA 019 052 S03	M2.5 x 0.45	M2.5 x 0.35 M3 x 0.35	3-48	3-56		4	B	1.9	5.2	45	3
4MTMA 020 090 S03	M2.5 x 0.45	M2.6 x 0.45	4-40	4-48		4	A	2	9	45	3
4MTMA 0237 0106 S03	M3 x 0.5	M3.5 x 0.5 M4 x 0.5				4	A	2.37	10.6	45	3
4MTMA 0245 070 S03	M3 x 0.5	M3.5 x 0.5	5-40	5-44		4	B	2.45	7	45	3
4MTMA 032 095 S06	M3.5 x 0.6	M4 x 0.5	6-32	6-40		4	B	3.2	9.5	60	6
4MTMA 040 125 S06	M4 x 0.7	M4 x 0.5	8-32	8-36	10-28	4	B	3.2	9.5	60	6
4MTMA 040 125 S06	M4.5 x 0.75	M4 x 0.5	10-24	10-32		4	B	3.2	9.5	60	6
4MTMA 040 125 S06	M5 x 0.8	M5 x 0.5 M5.5 x 0.5 M5 x 0.75	12-24	12-28	10-36 10-40 10-48	4	B	4	12.5	60	6
4MTMA 065 166 S08	M6 x 1	M10 x 1.25 M12 x 1.25 M14 x 1.25				4	B	6.5	16.6	60	8
4MTMA 082 208 S10	M8 x 1.25	M12 x 1.5 M14 x 1.5 M16 x 1.5				4	B	8.2	20.8	70	10
4MTMA 099 250 S10	M10 x 1.5	M14 x 1.75 M16 x 1.75 M18 x 1.75				4	B	9.9	25	70	10

외부 급유형 (Without coolant)



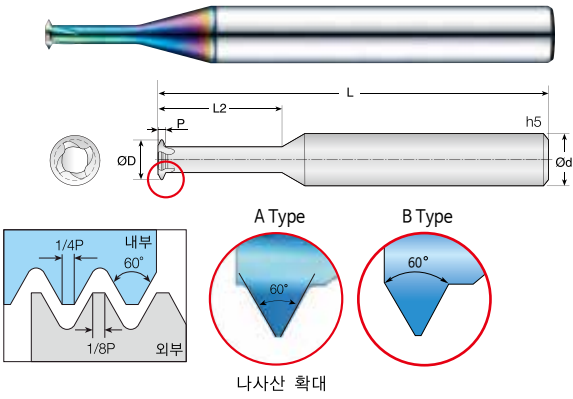

나사산 확대

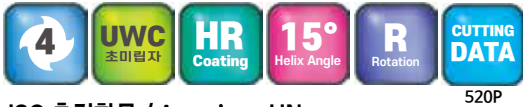

ISO 측정항목 / American UN

단위 Unit: mm

Order Number	미터나사 (Metric screw)		유니파이 나사 (Unified screw)			날수 (Flutes) Z	타입 (Type)	날경 (Diameter) D	유효장 (Effective Length) L2	전장 (Overall Length) L	샹크 (Shank Dia) d
	일반 나사 (M Coarse)	가는 나사 (M Fine)	UNC	UNF	UNS						
4MTMS 0072 036 S03	M1 × 0.25					4	A	0.72	3.6	45	3
4MTMS 009 043 S03	M1.2 × 0.25	M1.4 × 0.25 M1.6 × 0.25				4	A	0.9	4.3	45	3
4MTMS 0105 050 S03	M1.4 × 0.3					4	A	1.05	5	45	3
4MTMS 0115 031 S03	M1.6 × 0.35	M1.6 × 0.25 M1.8 × 0.25 M2 × 0.25		0-80		4	B	1.15	3.1	45	3
4MTMS 012 057 S03	M1.6 × 0.35	M2 × 0.35 M2.2 × 0.35				4	A	1.2	5.7	45	3
4MTMS 014 037 S03	M2 × 0.4	M2 × 0.35	1-64	1-72		4	B	1.4	3.7	45	3
4MTMS 0155 071 S03	M2.2 × 0.45	M2.2 × 0.35	2-56	2-64		4	A	1.55	7.1	45	3
4MTMS 019 052 S03	M2 × 0.4					4	A	1.55	7.1	45	3
4MTMS 019 052 S03	M2.5 × 0.45	M2.5 × 0.35 M3 × 0.35	3-48 4-40	3-56 4-48		4	B	1.9	5.2	45	3
4MTMS 020 090 S03	M2.5 × 0.45	M2.6 × 0.45				4	A	2	9	45	3
4MTMS 0237 0106 S03	M3 × 0.5	M3.5 × 0.5 M4 × 0.5				4	A	2.37	10.6	45	3
4MTMS 0245 070 S03	M3 × 0.5	M3.5 × 0.5	5-40 6-32	5-44 6-40		4	B	2.45	7	45	3
4MTMS 032 095 S06	M4 × 0.7	M4 × 0.5	8-32 10-24	8-36 10-32	10-28	4	B	3.2	9.5	60	6
4MTMS 040 125 S06	M4.5 × 0.75					4	B	3.2	9.5	60	6
4MTMS 040 125 S06	M5 × 0.8 M6 × 1	M5 × 0.5 M5.5 × 0.5 M5 × 0.75	12-24	12-28	10-36 10-40 10-48	4	B	4	12.5	60	6
4MTMS 065 166 S08	M8 × 1.25	M10 × 1.25 M12 × 1.25 M14 × 1.25				4	B	6.5	16.6	60	8
4MTMS 082 208 S10	M10 × 1.5	M12 × 1.5 M14 × 1.5 M16 × 1.5				4	B	8.2	20.8	70	10
4MTMS 099 250 S10	M12 × 1.75	M14 × 1.75 M16 × 1.75 M18 × 1.75				4	B	9.9	25	70	10

외부 급유형 (Without coolant)

# 4STM 4 Flutes Short Flute Thread Mills for Multi Purpose

## 4날 범용 짧은 날 쓰레드밀

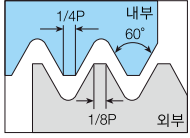
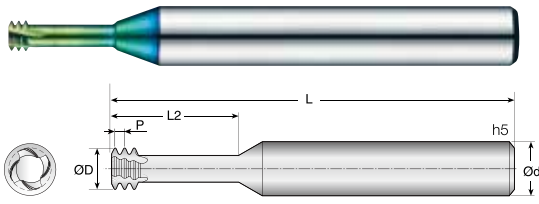

- HRC 58이하의 열처리강, 프리하든강, 합금강, 탄소강, 주철 가공
- 경화강 내 나사 가공을 위한 견고하고 강력한 날 디자인.
- 향상된 절삭 및 칩제거를 통해 공구 성능을 향상 시킵니다.
- 팁 형상은 절삭 저항을 줄이고 공구 구부림을 억제합니다.
- 헬리코일 나사 가공이 가능합니다.
- 오른나사 및 왼나사 작업이 모두 가능합니다.

### Thread mills for Hardened steels (up to HRC 58), pre-hardened steels, alloy steels, carbon steels, cast irons

- Powerful flute design applied for hardened steel.
- Improved cutting and chip removal reduce the risk of tool breaking in holes.
- The tip shape reduces cutting resistance and tool bend.
- It can be used for heli coil threading.
- It can be used for both right and left-handed threading.



ISO 측정항목

521P

단위 Unit: mm

Order Number	피치규격		날수 Flutes Z	산수 Teeth Zt	날경 Diameter D	유효장 Effective Length L2	전장 Overall Length L	샙크 Shank Dia d
	Thread	Pitch						
<b>외부급유형 (Without coolant)</b>								
4STM 0072 020 S04 M1	M1	0.25	4	3	0.72	2	45	4
4STM 0072 025 S04 M1	M1	0.25	4	3	0.72	2.5	45	4
4STM 009 024 S04 M012	M1.2	0.25	4	3	0.9	2.4	45	4
4STM 009 030 S04 M012	M1.2	0.25	4	3	0.9	3	45	4
4STM 0095 028 S06 M014	M1.4	0.3	4	3	0.95	2.8	50	6
4STM 0095 035 S06 M014	M1.4	0.3	4	3	0.95	3.5	50	6
4STM 011 032 S06 M016	M1.6 ~ 1.8	0.35	4	3	1.1	3.2	50	6
4STM 011 040 S06 M016	M1.6 ~ 1.8	0.35	4	3	1.1	4	50	6
4STM 012 050 S03 M016	M1.6 ~ 1.8	0.35	4	3	1.2	5	40	3
4STM 014 040 S06 M2	M2	0.4	4	3	1.4	4	50	6
4STM 014 050 S06 M2	M2	0.4	4	3	1.4	5	50	6
4STM 0155 062 S03 M2	M2	0.4	4	3	1.55	6.2	40	3
4STM 0155 062 S06 M2	M2	0.4	4	3	1.55	6.2	60	6
4STM 016 044 S06 M022	M2.2	0.45	4	3	1.6	4.4	50	6
4STM 016 055 S06 M022	M2.2	0.45	4	3	1.6	5.5	50	6
4STM 018 050 S06 M025	M2.5	0.45	4	3	1.8	5	50	6
4STM 018 0625 S06 M025	M2.5	0.45	4	3	1.8	6.25	50	6
4STM 0195 077 S03 M025	M2.5	0.45	4	3	1.95	7.7	40	3
4STM 0195 077 S06 M025	M2.5	0.45	4	3	1.95	7.7	60	6
4STM 024 060 S06 M3	M3	0.5	4	3	2.4	6	50	6
4STM 024 075 S06 M3	M3	0.5	4	3	2.4	7.5	50	6
4STM 024 092 S03 M3	M3	0.5	4	3	2.4	9.2	40	3
4STM 024 092 S06 M3	M3	0.5	4	3	2.4	9.2	60	6
4STM 0275 108 S06 M035	M3.5	0.6	4	3	2.75	10.8	60	6
4STM 031 080 S06 M4	M4	0.7	4	3	3.1	8	50	6
4STM 031 100 S06 M4	M4	0.7	4	3	3.1	10	50	6
4STM 0315 123 S06 M4	M4	0.7	4	3	3.15	12.3	60	6
4STM 038 100 S06 M5	M5	0.8	4	3	3.8	10	50	6
4STM 038 125 S06 M5	M5	0.8	4	3	3.8	12.5	50	6
4STM 0405 154 S06 M5	M5	0.8	4	3	4.05	15.4	60	6
4STM 046 120 S06 M6	M6	1	4	3	4.6	12	50	6
4STM 046 150 S06 M6	M6	1	4	3	4.6	15	50	6
4STM 048 185 S06 M6	M6	1	4	3	4.8	18.5	60	6
4STM 062 160 S10 M8	M8	1.25	4	3	6.2	16	70	10
4STM 062 200 S10 M8	M8	1.25	4	3	6.2	20	70	10
4STM 065 246 S08 M8	M8	1.25	4	3	6.5	24.6	65	8
4STM 075 200 S10 M10	M10	1.5	4	3	7.5	20	70	10
4STM 075 250 S10 M10	M10	1.5	4	3	7.5	25	70	10
4STM 082 308 S10 M10	M10	1.5	4	3	8.2	30.8	80	10
4STM 090 240 S10 M12	M12	1.75	4	3	9	24	80	10
4STM 090 300 S10 M12	M12	1.75	4	3	9	30	80	10
4STM 099 370 S10 M12	M12	1.75	4	3	9.9	37	85	10
4STM 115 320 S12 M16	M16	2	4	3	11.5	32	100	12
4STM 115 400 S12 M16	M16	2	4	3	11.5	40	100	12
4STM 119 490 S12 M16	M16	2	4	3	11.9	49	95	12

ISO 측정항목

단위 Unit: mm

Order Number	피치규격		날수 Flutes Z	산수 Teeth Zt	날경 Diameter D	유효장 Effective Length L2	전장 Overall Length L	생크 Shank Dia d
	Thread	Pitch						
<b>외부 급유형 (Without coolant)</b>								
4STM 140 360 S16 M18	M18	2.5	4	3	14	36	135	16
4STM 140 450 S16 M18	M18	2.5	4	3	14	45	135	16
4STM 150 400 S16 M20	M20	2.5	4	3	15	40	135	16
4STM 150 500 S16 M20	M20	2.5	4	3	15	50	135	16
4STM 159 613 S16 M20	M20	2.5	4	3	15.9	61.3	115	16

<b>내부 급유형 (With coolant)</b>								
4STM 031 080 S06 M4C	M4	0.7	4	3	3.1	8	50	6
4STM 031 100 S06 M4C	M4	0.7	4	3	3.1	10	50	6
4STM 038 100 S06 M5C	M5	0.8	4	3	3.8	10	50	6
4STM 038 125 S06 M5C	M5	0.8	4	3	3.8	12.5	50	6
4STM 046 120 S06 M6C	M6	1	4	3	4.6	12	50	6
4STM 046 150 S06 M6C	M6	1	4	3	4.6	15	50	6
4STM 048 185 S06 M6C	M6	1	4	3	4.8	18.5	60	6
4STM 062 160 S10 M8C	M8	1.25	4	3	6.2	16	70	10
4STM 062 200 S10 M8C	M8	1.25	4	3	6.2	20	70	10
4STM 065 246 S08 M8C	M8	1.25	4	3	6.5	24.6	65	8
4STM 075 200 S10 M10C	M10	1.5	4	3	7.5	20	70	10
4STM 075 250 S10 M10C	M10	1.5	4	3	7.5	25	70	10
4STM 082 308 S10 M10C	M10	1.5	4	3	8.2	30.8	80	10
4STM 090 240 S10 M12C	M12	1.75	4	3	9	24	80	10
4STM 090 300 S10 M12C	M12	1.75	4	3	9	30	80	10
4STM 099 370 S10 M12C	M12	1.75	4	3	9.9	37	85	10
4STM 115 320 S12 M16C	M16	2	4	3	11.5	32	100	12
4STM 115 400 S12 M16C	M16	2	4	3	11.5	40	100	12
4STM 119 490 S12 M16C	M16	2	4	3	11.9	49	95	12
4STM 140 360 S16 M18C	M18	2.5	4	3	14	36	135	16
4STM 140 450 S16 M18C	M18	2.5	4	3	14	45	135	16
4STM 150 400 S16 M20C	M20	2.5	4	3	15	40	135	16
4STM 150 500 S16 M20C	M20	2.5	4	3	15	50	135	16
4STM 159 613 S16 M20C	M20	2.5	4	3	15.9	61.3	115	16



American UN

단위 Unit: mm

Order Number	피치규격 Thread			날수 Flutes Z	산수 Teeth Zt	날경 Diameter D	유효장 Effective Length L2	전장 Overall Length L	샙크 Shank Dia d
	UNC	UNF	Pitch						

외부급유형 (Without coolant)

4STM 014 037 S06	No.1-64		64	4	3	1.4	3.7	50	6
4STM 014 046 S06	No.1-64		64	4	3	1.4	4.6	50	6
4STM 0165 044 S06	No.2-56		56	4	3	1.65	4.4	50	6
4STM 0165 055 S06	No.2-56		56	4	3	1.65	5.5	50	6
4STM 019 050 S06	No. 3-48		48	4	3	1.9	5	50	6
4STM 019 063 S06	No. 3-48		48	4	3	1.9	6.3	50	6
4STM 021 057 S06	No. 4-40		40	4	3	2.1	5.7	50	6
4STM 021 071 S06	No. 4-40		40	4	3	2.1	7.1	50	6
4STM 0255 070 S06	No. 6-32		32	4	3	2.55	7	50	6
4STM 0255 088 S06	No. 6-32		32	4	3	2.55	8.8	50	6
4STM 033 083 S06		No. 8-36	36	4	3	3.3	8.3	50	6
4STM 033 104 S06		No. 8-36	36	4	3	3.3	10.4	50	6
4STM 035 097 S06	No. 10-24		24	4	3	3.5	9.7	65	6
4STM 035 121 S06	No. 10-24		24	4	3	3.5	12.1	65	6
4STM 0475 127 S06	1/4" x 20		20	4	3	4.75	12.7	65	6
4STM 0475 159 S06	1/4" x 20		20	4	3	4.75	15.9	65	6
4STM 050 127 S06		1/4" x 28	28	4	3	5	12.7	65	6
4STM 050 159 S06		1/4" x 28	28	4	3	5	15.9	65	6
4STM 060 159 S10	5/16" x 18		18	4	3	6	15.9	80	10
4STM 060 198 S10	5/16" x 18		18	4	3	6	19.8	80	10
4STM 067 191 S10	3/8" x 16		16	4	3	6.7	19.1	80	10
4STM 067 238 S10	3/8" x 16		16	4	3	6.7	23.8	80	10
4STM 077 222 S10	7/16" x 14		14	4	3	7.7	22.2	80	10
4STM 077 278 S10	7/16" x 14		14	4	3	7.7	27.8	80	10
4STM 092 254 S10	1/2" x 13		13	4	3	9.2	25.4	80	10
4STM 092 318 S10	1/2" x 13		13	4	3	9.2	31.8	80	10
4STM 105 286 S12	9/16" x 12		12	4	3	10.5	28.6	100	12
4STM 105 357 S12	9/16" x 12		12	4	3	10.5	35.7	100	12
4STM 114 318 S12	5/8" x 11		11	4	3	11.4	31.8	100	12
4STM 114 397 S12	5/8" x 11		11	4	3	11.4	39.7	100	12

내부급유형 (With coolant)

4STM 033 083 S06C		No. 8-36	36	4	3	3.3	8.3	50	6
4STM 033 104 S06C		No. 8-36	36	4	3	3.3	10.4	50	6
4STM 035 097 S06C	No. 10-24		24	4	3	3.5	9.7	65	6
4STM 035 121 S06C	No. 10-24		24	4	3	3.5	12.1	65	6
4STM 0475 127 S06C	1/4" x 20		20	4	3	4.75	12.7	65	6
4STM 0475 159 S06C	1/4" x 20		20	4	3	4.75	15.9	65	6
4STM 050 127 S06C		1/4" x 28	28	4	3	5	12.7	65	6
4STM 050 159 S06C		1/4" x 28	28	4	3	5	15.9	65	6
4STM 060 159 S10C	5/16" x 18		18	4	3	6	15.9	80	10
4STM 060 198 S10C	5/16" x 18		18	4	3	6	19.8	80	10
4STM 067 191 S10C	3/8" x 16		16	4	3	6.7	19.1	80	10
4STM 067 238 S10C	3/8" x 16		16	4	3	6.7	23.8	80	10
4STM 077 222 S10C	7/16" x 14		14	4	3	7.7	22.2	80	10
4STM 077 278 S10C	7/16" x 14		14	4	3	7.7	27.8	80	10
4STM 092 254 S10C	1/2" x 13		13	4	3	9.2	25.4	80	10
4STM 092 318 S10C	1/2" x 13		13	4	3	9.2	31.8	80	10
4STM 105 286 S12C	9/16" x 12		12	4	3	10.5	28.6	100	12
4STM 105 357 S12C	9/16" x 12		12	4	3	10.5	35.7	100	12
4STM 114 318 S12C	5/8" x 11		11	4	3	11.4	31.8	100	12
4STM 114 397 S12C	5/8" x 11		11	4	3	11.4	39.7	100	12

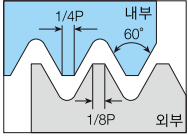
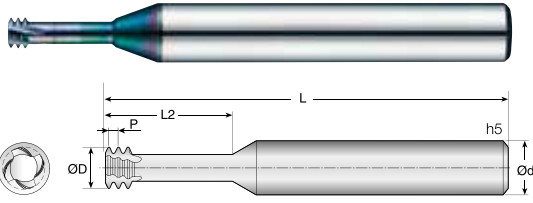

- 알루미늄, 알루미늄 합금 등 비철 비금속 가공
- 경화강 내 나사 가공을 위한 견고하고 강력한 날 디자인.
- 향상된 절삭 및 칩제거를 통해 공구 성능을 향상 시킵니다.
- 팁 형상은 절삭 저항을 줄이고 공구 구부림을 억제합니다.
- 헬리코일 나사 가공이 가능합니다.
- 오른나사 및 왼나사 작업이 모두 가능합니다.

#### Thread Mills for Aluminum, Aluminum alloys, non-ferrous and non-metallic materials

- Powerful flute design applied for hardened steel.
- Improved cutting and chip removal reduce the risk of tool breaking in holes.
- The tip shape reduces cutting resistance and tool bend.
- It can be used for heli coil threading.
- It can be used for both right and left-handed threading.



521P

#### ISO 측정항목

단위 Unit: mm

Order Number	피치 규격		날수 Flutes Z	산수 Teeth Zt	날경 Diameter D	유효장 Effective Length L2	전장 Overall Length L	샹크 Shank Dia d
	Thread	Pitch						

#### 외부 급유형 (Without coolant)

4STMA 0072 020 S04 M1	M1	0.25	4	3	0.72	2	45	4
4STMA 0072 025 S04 M1	M1	0.25	4	3	0.72	2.5	45	4
4STMA 009 024 S04 M012	M1.2	0.25	4	3	0.9	2.4	45	4
4STMA 009 030 S04 M012	M1.2	0.25	4	3	0.9	3	45	4
4STMA 0095 028 S06 M014	M1.4	0.3	4	3	0.95	2.8	50	6
4STMA 0095 035 S06 M014	M1.4	0.3	4	3	0.95	3.5	50	6
4STMA 011 032 S06 M016	M1.6 ~ 1.8	0.35	4	3	1.1	3.2	50	6
4STMA 011 040 S06 M016	M1.6 ~ 1.8	0.35	4	3	1.1	4	50	6
4STMA 012 050 S03 M016	M1.6 ~ 1.8	0.35	4	3	1.2	5	40	3
4STMA 014 040 S06 M2	M2	0.4	4	3	1.4	4	50	6
4STMA 014 050 S06 M2	M2	0.4	4	3	1.4	5	50	6
4STMA 0155 062 S03 M2	M2	0.4	4	3	1.55	6.2	40	3
4STMA 0155 062 S06 M2	M2	0.4	4	3	1.55	6.2	60	6
4STMA 016 044 S06 M022	M2.2	0.45	4	3	1.6	4.4	50	6
4STMA 016 055 S06 M022	M2.2	0.45	4	3	1.6	5.5	50	6
4STMA 018 050 S06 M025	M2.5	0.45	4	3	1.8	5	50	6
4STMA 018 0625 S06 M025	M2.5	0.45	4	3	1.8	6.25	50	6
4STMA 0195 077 S03 M025	M2.5	0.45	4	3	1.95	7.7	40	3
4STMA 0195 077 S06 M025	M2.5	0.45	4	3	1.95	7.7	60	6
4STMA 024 060 S06 M3	M3	0.5	4	3	2.4	6	50	6
4STMA 024 075 S06 M3	M3	0.5	4	3	2.4	7.5	50	6
4STMA 024 092 S03 M3	M3	0.5	4	3	2.4	9.2	40	3
4STMA 024 092 S06 M3	M3	0.5	4	3	2.4	9.2	60	6
4STMA 0275 108 S06 M035	M3.5	0.6	4	3	2.75	10.8	60	6
4STMA 031 080 S06 M4	M4	0.7	4	3	3.1	8	50	6
4STMA 031 100 S06 M4	M4	0.7	4	3	3.1	10	50	6
4STMA 0315 123 S06 M4	M4	0.7	4	3	3.15	12.3	60	6
4STMA 038 100 S06 M5	M5	0.8	4	3	3.8	10	50	6
4STMA 038 125 S06 M5	M5	0.8	4	3	3.8	12.5	50	6
4STMA 0405 154 S06 M5	M5	0.8	4	3	4.05	15.4	60	6
4STMA 046 120 S06 M6	M6	1	4	3	4.6	12	50	6
4STMA 046 150 S06 M6	M6	1	4	3	4.6	15	50	6
4STMA 048 185 S06 M6	M6	1	4	3	4.8	18.5	60	6
4STMA 062 160 S10 M8	M8	1.25	4	3	6.2	16	70	10
4STMA 062 200 S10 M8	M8	1.25	4	3	6.2	20	70	10
4STMA 065 246 S08 M8	M8	1.25	4	3	6.5	24.6	65	8
4STMA 075 200 S10 M10	M10	1.5	4	3	7.5	20	70	10
4STMA 075 250 S10 M10	M10	1.5	4	3	7.5	25	70	10
4STMA 082 308 S10 M10	M10	1.5	4	3	8.2	30.8	80	10
4STMA 090 240 S10 M12	M12	1.75	4	3	9	24	80	10
4STMA 090 300 S10 M12	M12	1.75	4	3	9	30	80	10
4STMA 099 370 S10 M12	M12	1.75	4	3	9.9	37	85	10
4STMA 115 320 S12 M16	M16	2	4	3	11.5	32	100	12
4STMA 115 400 S12 M16	M16	2	4	3	11.5	40	100	12
4STMA 119 490 S12 M16	M16	2	4	3	11.9	49	95	12

ISO 측정항목

단위 Unit: mm

Order Number	피치 규격		날수 Flutes Z	산수 Teeth Zt	날경 Diameter D	유효장 Effective Length L2	전장 Overall Length L	생크 Shank Dia d
	Thread	Pitch						
<b>외부 급유형 (Without coolant)</b>								
4STMA 140 360 S16 M18	M18	2.5	4	3	14	36	135	16
4STMA 140 450 S16 M18	M18	2.5	4	3	14	45	135	16
4STMA 150 400 S16 M20	M20	2.5	4	3	15	40	135	16
4STMA 150 500 S16 M20	M20	2.5	4	3	15	50	135	16
4STMA 159 613 S16 M20	M20	2.5	4	3	15.9	61.3	115	16

<b>내부 급유형 (With coolant)</b>								
4STMA 031 080 S06 M4C	M4	0.7	4	3	3.1	8	50	6
4STMA 031 100 S06 M4C	M4	0.7	4	3	3.1	10	50	6
4STMA 038 100 S06 M5C	M5	0.8	4	3	3.8	10	50	6
4STMA 038 125 S06 M5C	M5	0.8	4	3	3.8	12.5	50	6
4STMA 046 120 S06 M6C	M6	1	4	3	4.6	12	50	6
4STMA 046 150 S06 M6C	M6	1	4	3	4.6	15	50	6
4STMA 048 185 S06 M6C	M6	1	4	3	4.8	18.5	60	6
4STMA 062 160 S10 M8C	M8	1.25	4	3	6.2	16	70	10
4STMA 062 200 S10 M8C	M8	1.25	4	3	6.2	20	70	10
4STMA 065 246 S08 M8C	M8	1.25	4	3	6.5	24.6	65	8
4STMA 075 200 S10 M10C	M10	1.5	4	3	7.5	20	70	10
4STMA 075 250 S10 M10C	M10	1.5	4	3	7.5	25	70	10
4STMA 082 308 S10 M10C	M10	1.5	4	3	8.2	30.8	80	10
4STMA 090 240 S10 M12C	M12	1.75	4	3	9	24	80	10
4STMA 090 300 S10 M12C	M12	1.75	4	3	9	30	80	10
4STMA 099 370 S10 M12C	M12	1.75	4	3	9.9	37	85	10
4STMA 115 320 S12 M16C	M16	2	4	3	11.5	32	100	12
4STMA 115 400 S12 M16C	M16	2	4	3	11.5	40	100	12
4STMA 119 490 S12 M16C	M16	2	4	3	11.9	49	95	12
4STMA 140 360 S16 M18C	M18	2.5	4	3	14	36	135	16
4STMA 140 450 S16 M18C	M18	2.5	4	3	14	45	135	16
4STMA 150 400 S16 M20C	M20	2.5	4	3	15	40	135	16
4STMA 150 500 S16 M20C	M20	2.5	4	3	15	50	135	16
4STMA 159 613 S16 M20C	M20	2.5	4	3	15.9	61.3	115	16

THREAD MILL

American UN

단위 Unit: mm

Order Number	피치규격 Thread			날수 Flutes Z	산수 Teeth Zt	날경 Diameter D	유효장 Effective Length L2	전장 Overall Length L	샹크 Shank Dia d
	UNC	UNF	Pitch						
	<b>외부금유형 (Without coolant)</b>								
4STMA 014 037 S06	No. 1-64		64	4	3	1.4	3.7	50	6
4STMA 014 046 S06	No. 1-64		64	4	3	1.4	4.6	50	6
4STMA 0165 044 S06	No. 2-56		56	4	3	1.65	4.4	50	6
4STMA 0165 055 S06	No. 2-56		56	4	3	1.65	5.5	50	6
4STMA 019 050 S06	No. 3-48		48	4	3	1.9	5	50	6
4STMA 019 063 S06	No. 3-48		48	4	3	1.9	6.3	50	6
4STMA 021 057 S06	No. 4-40		40	4	3	2.1	5.7	50	6
4STMA 021 071 S06	No. 4-40		40	4	3	2.1	7.1	50	6
4STMA 0255 070 S06	No. 6-32		32	4	3	2.55	7	50	6
4STMA 0255 088 S06	No. 6-32		32	4	3	2.55	8.8	50	6
4STMA 033 083 S06		No. 8-36	36	4	3	3.3	8.3	50	6
4STMA 033 104 S06		No. 8-36	36	4	3	3.3	10.4	50	6
4STMA 035 097 S06	No. 10-24		24	4	3	3.5	9.7	65	6
4STMA 035 121 S06	No. 10-24		24	4	3	3.5	12.1	65	6
4STMA 0475 127 S06	1/4" x 20		20	4	3	4.75	12.7	65	6
4STMA 0475 159 S06	1/4" x 20		20	4	3	4.75	15.9	65	6
4STMA 050 127 S06		1/4" x 28	28	4	3	5	12.7	65	6
4STMA 050 159 S06		1/4" x 28	28	4	3	5	15.9	65	6
4STMA 060 159 S10	5/16" x 18		18	4	3	6	15.9	80	10
4STMA 060 198 S10	5/16" x 18		18	4	3	6	19.8	80	10
4STMA 067 191 S10	3/8" x 16		16	4	3	6.7	19.1	80	10
4STMA 067 238 S10	3/8" x 16		16	4	3	6.7	23.8	80	10
4STMA 077 222 S10	7/16" x 14		14	4	3	7.7	22.2	80	10
4STMA 077 278 S10	7/16" x 14		14	4	3	7.7	27.8	80	10
4STMA 092 254 S10	1/2" x 13		13	4	3	9.2	25.4	80	10
4STMA 092 318 S10	1/2" x 13		13	4	3	9.2	31.8	80	10
4STMA 105 286 S12	9/16" x 12		12	4	3	10.5	28.6	100	12
4STMA 105 357 S12	9/16" x 12		12	4	3	10.5	35.7	100	12
4STMA 114 318 S12	5/8" x 11		11	4	3	11.4	31.8	100	12
4STMA 14 397 S12	5/8" x 11		11	4	3	11.4	39.7	100	12

<b>내부금유형 (With coolant)</b>									
4STMA 033 083 S06C		No. 8-36	36	4	3	3.3	8.3	50	6
4STMA 033 104 S06C		No. 8-36	36	4	3	3.3	10.4	50	6
4STMA 035 097 S06C	No. 10-24		24	4	3	3.5	9.7	65	6
4STMA 035 121 S06C	No. 10-24		24	4	3	3.5	12.1	65	6
4STMA 0475 127 S06C	1/4" x 20		20	4	3	4.75	12.7	65	6
4STMA 0475 159 S06C	1/4" x 20		20	4	3	4.75	15.9	65	6
4STMA 050 127 S06C		1/4" x 28	28	4	3	5	12.7	65	6
4STMA 050 159 S06C		1/4" x 28	28	4	3	5	15.9	65	6
4STMA 060 159 S10C	5/16" x 18		18	4	3	6	15.9	80	10
4STMA 060 198 S10C	5/16" x 18		18	4	3	6	19.8	80	10
4STMA 067 191 S10C	3/8" x 16		16	4	3	6.7	19.1	80	10
4STMA 067 238 S10C	3/8" x 16		16	4	3	6.7	23.8	80	10
4STMA 077 222 S10C	7/16" x 14		14	4	3	7.7	22.2	80	10
4STMA 077 278 S10C	7/16" x 14		14	4	3	7.7	27.8	80	10
4STMA 092 254 S10C	1/2" x 13		13	4	3	9.2	25.4	80	10
4STMA 092 318 S10C	1/2" x 13		13	4	3	9.2	31.8	80	10
4STMA 105 286 S12C	9/16" x 12		12	4	3	10.5	28.6	100	12
4STMA 105 357 S12C	9/16" x 12		12	4	3	10.5	35.7	100	12
4STMA 114 318 S12C	5/8" x 11		11	4	3	11.4	31.8	100	12
4STMA 114 397 S12C	5/8" x 11		11	4	3	11.4	39.7	100	12

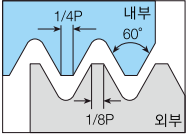
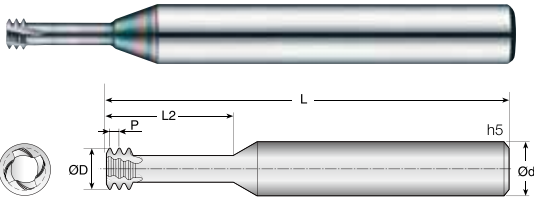

- SUS, 티타늄 합금 가공
  - 경화강 내 나사 가공을 위한 견고하고 강력한 날 디자인.
  - 향상된 절삭 및 칩제거를 통해 공구가 구멍안에서 끊어지는 위험을 줄입니다.
  - 팁 형상은 절삭 저항을 줄이고 공구 구부림을 억제합니다.
  - 헬리코일 나사로 사용이 가능합니다.
  - 오른나사 및 왼나사 작업이 모두 가능합니다.
- Thread Mills for SUS, Titanium alloys
  - Powerful flute design applied for hardened steel.
  - Improved cutting and chip removal reduce the risk of tool breaking in holes.
  - The tip shape reduces cutting resistance and tool bend.
  - It can be used for heli coil threading.
  - It can be used for both right and left-handed threading.



521P

ISO 측정항목

단위 Unit: mm

Order Number	피치 규격		날수 Flutes Z	산수 Teeth Zt	날경 Diameter D	유효장 Effective Length L2	전장 Overall Length L	샹크 Shank Dia d
	Thread	Pitch						

외부 급유형 (Without coolant)

4STMS 0072 020 S04 M1	M1	0.25	4	3	0.72	2	45	4
4STMS 0072 025 S04 M1	M1	0.25	4	3	0.72	2.5	45	4
4STMS 009 024 S04 M012	M1.2	0.25	4	3	0.9	2.4	45	4
4STMS 009 030 S04 M012	M1.2	0.25	4	3	0.9	3	45	4
4STMS 0095 028 S06 M014	M1.4	0.3	4	3	0.95	2.8	50	6
4STMS 0095 035 S06 M014	M1.4	0.3	4	3	0.95	3.5	50	6
4STMS 011 032 S06 M016	M1.6 ~ 1.8	0.35	4	3	1.1	3.2	50	6
4STMS 011 040 S06 M016	M1.6 ~ 1.8	0.35	4	3	1.1	4	50	6
4STMS 012 050 S03 M016	M1.6 ~ 1.8	0.35	4	3	1.2	5	40	3
4STMS 014 040 S06 M2	M2	0.4	4	3	1.4	4	50	6
4STMS 14 050 S06 M2	M2	0.4	4	3	1.4	5	50	6
4STMS 0155 062 S03 M2	M2	0.4	4	3	1.55	6.2	40	3
4STMS 0155 062 S06 M2	M2	0.4	4	3	1.55	6.2	60	6
4STMS 016 044 S06 M022	M2.2	0.45	4	3	1.6	4.4	50	6
4STMS 016 055 S06 M022	M2.2	0.45	4	3	1.6	5.5	50	6
4STMS 018 050 S06 M025	M2.5	0.45	4	3	1.8	5	50	6
4STMS 018 0625 S06 M025	M2.5	0.45	4	3	1.8	6.25	50	6
4STMS 0195 077 S03 M025	M2.5	0.45	4	3	1.95	7.7	40	3
4STMS 0195 077 S06 M025	M2.5	0.45	4	3	1.95	7.7	60	6
4STMS 024 060 S06 M3	M3	0.5	4	3	2.4	6	50	6
4STMS 024 075 S06 M3	M3	0.5	4	3	2.4	7.5	50	6
4STMS 024 092 S03 M3	M3	0.5	4	3	2.4	9.2	40	3
4STMS 024 092 S06 M3	M3	0.5	4	3	2.4	9.2	60	6
4STMS 0275 108 S06 M3.5	M3.5	0.6	4	3	2.75	10.8	60	6
4STMS 031 080 S06 M4	M4	0.7	4	3	3.1	8	50	6
4STMS 031 100 S06 M4	M4	0.7	4	3	3.1	10	50	6
4STMS 0315 123 S06 M4	M4	0.7	4	3	3.15	12.3	60	6
4STMS 038 100 S06 M5	M5	0.8	4	3	3.8	10	50	6
4STMS 038 125 S06 M5	M5	0.8	4	3	3.8	12.5	50	6
4STMS 0405 154 S06 M5	M5	0.8	4	3	4.05	15.4	60	6
4STMS 046 120 S06 M6	M6	1	4	3	4.6	12	50	6
4STMS 046 150 S06 M6	M6	1	4	3	4.6	15	50	6
4STMS 048 185 S06 M6	M6	1	4	3	4.8	18.5	60	6
4STMS 062 160 S10 M8	M8	1.25	4	3	6.2	16	70	10
4STMS 062 200 S10 M8	M8	1.25	4	3	6.2	20	70	10
4STMS 065 246 S08 M8	M8	1.25	4	3	6.5	24.6	65	8
4STMS 075 200 S10 M10	M10	1.5	4	3	7.5	20	70	10
4STMS 075 250 S10 M10	M10	1.5	4	3	7.5	25	70	10
4STMS 082 308 S10 M10	M10	1.5	4	3	8.2	30.8	80	10
4STMS 090 240 S10 M12	M12	1.75	4	3	9	24	80	10
4STMS 090 300 S10 M12	M12	1.75	4	3	9	30	80	10
4STMS 099 370 S10 M12	M12	1.75	4	3	9.9	37	85	10
4STMS 115 320 S12 M16	M16	2	4	3	11.5	32	100	12
4STMS 115 400 S12 M16	M16	2	4	3	11.5	40	100	12
4STMS 119 490 S12 M16	M16	2	4	3	11.9	49	95	12



ISO 측정항목

단위 Unit: mm

Order Number	피치 규격		날수 Flutes Z	산수 Teeth Zt	날경 Diameter D	유효장 Effective Length L2	전장 Overall Length L	생크 Shank Dia d
	Thread	Pitch						
<b>외부 급유형 (Without coolant)</b>								
4STMS 140 360 S16 M18	M18	2.5	4	3	14	36	135	16
4STMS 140 450 S16 M18	M18	2.5	4	3	14	45	135	16
4STMS 150 400 S16 M20	M20	2.5	4	3	15	40	135	16
4STMS 150 500 S16 M20	M20	2.5	4	3	15	50	135	16
4STMS 159 613 S16 M20	M20	2.5	4	3	15.9	61.3	115	16

<b>내부 급유형 (With coolant)</b>								
4STMS 031 080 S06 M4C	M4	0.7	4	3	3.1	8	50	6
4STMS 031 100 S06 M4C	M4	0.7	4	3	3.1	10	50	6
4STMS 038 100 S06 M5C	M5	0.8	4	3	3.8	10	50	6
4STMS 038 125 S06 M5C	M5	0.8	4	3	3.8	12.5	50	6
4STMS 046 120 S06 M6C	M6	1	4	3	4.6	12	50	6
4STMS 046 150 S06 M6C	M6	1	4	3	4.6	15	50	6
4STMS 048 185 S06 M6C	M6	1	4	3	4.8	18.5	60	6
4STMS 062 160 S10 M8C	M8	1.25	4	3	6.2	16	70	10
4STMS 062 200 S10 M8C	M8	1.25	4	3	6.2	20	70	10
4STMS 065 246 S08 M8C	M8	1.25	4	3	6.5	24.6	65	8
4STMS 075 200 S10 M10C	M10	1.5	4	3	7.5	20	70	10
4STMS 075 250 S10 M10C	M10	1.5	4	3	7.5	25	70	10
4STMS 082 308 S10 M10C	M10	1.5	4	3	8.2	30.8	80	10
4STMS 090 240 S10 M12C	M12	1.75	4	3	9	24	80	10
4STMS 090 300 S10 M12C	M12	1.75	4	3	9	30	80	10
4STMS 099 370 S10 M12C	M12	1.75	4	3	9.9	37	85	10
4STMS 115 320 S12 M16C	M16	2	4	3	11.5	32	100	12
4STMS 115 400 S12 M16C	M16	2	4	3	11.5	40	100	12
4STMS 119 490 S12 M16C	M16	2	4	3	11.9	49	95	12
4STMS 140 360 S16 M18C	M18	2.5	4	3	14	36	135	16
4STMS 140 450 S16 M18C	M18	2.5	4	3	14	45	135	16
4STMS 150 400 S16 M20C	M20	2.5	4	3	15	40	135	16
4STMS 150 500 S16 M20C	M20	2.5	4	3	15	50	135	16
4STMS 159 613 S16 M20C	M20	2.5	4	3	15.9	61.3	115	16

#### American UN

단위 Unit: mm

Order Number	피치규격 Thread			날수 Flutes Z	산수 Teeth Zt	날경 Diameter D	유효장 Effective Length L2	전장 Overall Length L	샹크 Shank Dia d
	UNC	UNF	Pitch						
<b>외부금유형 (Without coolant)</b>									
4STMS 014 037 S06	No.1-64		64	4	3	1.4	3.7	50	6
4STMS 014 046 S06	No.1-64		64	4	3	1.4	4.6	50	6
4STMS 0165 044 S06	No.2-56		56	4	3	1.65	4.4	50	6
4STMS 0165 055 S06	No.2-56		56	4	3	1.65	5.5	50	6
4STMS 019 050 S06	No. 3-48		48	4	3	1.9	5	50	6
4STMS 019 063 S06	No. 3-48		48	4	3	1.9	6.3	50	6
4STMS 021 057 S06	No. 4-40		40	4	3	2.1	5.7	50	6
4STMS 021 071 S06	No. 4-40		40	4	3	2.1	7.1	50	6
4STMS 0255 070 S06	No. 6-32		32	4	3	2.55	7	50	6
4STMS 0255 088 S06	No. 6-32		32	4	3	2.55	8.8	50	6
4STMS 033 083 S06		No. 8-36	36	4	3	3.3	8.3	50	6
4STMS 033 104 S06		No. 8-36	36	4	3	3.3	10.4	50	6
4STMS 035 097 S06	No. 10-24		24	4	3	3.5	9.7	65	6
4STMS 035 121 S06	No. 10-24		24	4	3	3.5	12.1	65	6
4STMS 0475 127 S06	1/4" x 20		20	4	3	4.75	12.7	65	6
4STMS 0475 159 S06	1/4" x 20		20	4	3	4.75	15.9	65	6
4STMS 050 127 S06		1/4" x 28	28	4	3	5	12.7	65	6
4STMS 050 159 S06		1/4" x 28	28	4	3	5	15.9	65	6
4STMS 060 159 S10	5/16" x 18		18	4	3	6	15.9	80	10
4STMS 060 198 S10	5/16" x 18		18	4	3	6	19.8	80	10
4STMS 067 191 S10	3/8" x 16		16	4	3	6.7	19.1	80	10
4STMS 067 238 S10	3/8" x 16		16	4	3	6.7	23.8	80	10
4STMS 077 222 S10	7/16" x 14		14	4	3	7.7	22.2	80	10
4STMS 077 278 S10	7/16" x 14		14	4	3	7.7	27.8	80	10
4STMS 092 254 S10	1/2" x 13		13	4	3	9.2	25.4	80	10
4STMS 092 318 S10	1/2" x 13		13	4	3	9.2	31.8	80	10
4STMS 105 286 S12	9/16" x 12		12	4	3	10.5	28.6	100	12
4STMS 105 357 S12	9/16" x 12		12	4	3	10.5	35.7	100	12
4STMS 114 318 S12	5/8" x 11		11	4	3	11.4	31.8	100	12
4STMS 14 397 S12	5/8" x 11		11	4	3	11.4	39.7	100	12

#### 내부금유형 (With coolant)

4STMS 033 083 S06C		No. 8-36	36	4	3	3.3	8.3	50	6
4STMS 033 104 S06C		No. 8-36	36	4	3	3.3	10.4	50	6
4STMS 035 097 S06C	No. 10-24		24	4	3	3.5	9.7	65	6
4STMS 035 121 S06C	No. 10-24		24	4	3	3.5	12.1	65	6
4STMS 0475 127 S06C	1/4" x 20		20	4	3	4.75	12.7	65	6
4STMS 0475 159 S06C	1/4" x 20		20	4	3	4.75	15.9	65	6
4STMS 050 127 S06C		1/4" x 28	28	4	3	5	12.7	65	6
4STMS 050 159 S06C		1/4" x 28	28	4	3	5	15.9	65	6
4STMS 060 159 S10C	5/16" x 18		18	4	3	6	15.9	80	10
4STMS 060 198 S10C	5/16" x 18		18	4	3	6	19.8	80	10
4STMS 067 191 S10C	3/8" x 16		16	4	3	6.7	19.1	80	10
4STMS 067 238 S10C	3/8" x 16		16	4	3	6.7	23.8	80	10
4STMS 077 222 S10C	7/16" x 14		14	4	3	7.7	22.2	80	10
4STMS 077 278 S10C	7/16" x 14		14	4	3	7.7	27.8	80	10
4STMS 092 254 S10C	1/2" x 13		13	4	3	9.2	25.4	80	10
4STMS 092 318 S10C	1/2" x 13		13	4	3	9.2	31.8	80	10
4STMS 105 286 S12C	9/16" x 12		12	4	3	10.5	28.6	100	12
4STMS 105 357 S12C	9/16" x 12		12	4	3	10.5	35.7	100	12
4STMS 114 318 S12C	5/8" x 11		11	4	3	11.4	31.8	100	12
4STMS 114 397 S12C	5/8" x 11		11	4	3	11.4	39.7	100	12

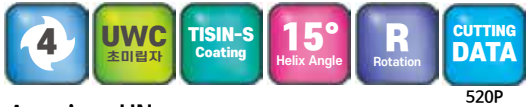
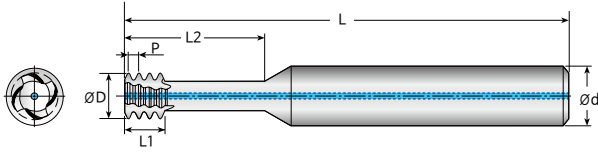

American UN

520P

- HRc 58이하의 고경도강, 프리하든강, 합금강, 탄소강, 주철 가공
- 경화강 내 나사 가공을 위한 견고하고 강력한 날 디자인.
- 향상된 절삭 및 칩 제거를 통해 공구 성능을 향상 시킵니다.
- 팁 형상은 절삭 저항을 줄이고 공구 구부림을 억제합니다.
- 오른나사 및 왼나사 작업이 모두 가능합니다.

#### Thread mills for Hardened steels (up to HRc 58), pre-hardened steels, alloy steels, carbon steels, cast irons

- Rigid and powerful flutes design for inside hardening steel.
- Enhanced threading enables chip removal smoothly to reduce possible breakage of tool inside hole.
- The shape of tip reduces friction and prevent tool bending.
- Both right and left threading are available.

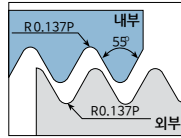

- 규격 정의 : B.S.2779:1956
- 공차 등급 : Medium class

단위 Unit: mm

Order Number	나사 가능 규격 Thread	피치 규격 Pitch (TPI)	날수 Flutes Z	산수 Teeth Zt	날경 Diameter D	나사부 길이 Thread Length L1	유효강 Effective Length L2	전강 Overall Length L	샙크 Shank Dia d
외부 급유형 (Without coolant)									
4BSP 060 095 S06	1/16", 1/8"	28	4	4	6	3.66	9.5	60	6
4BSP 060 158 S06	1/16", 1/8"	28	4	4	6	3.66	15.8	60	6
4BSP 080 140 S08	1/4", 3/8"	19	4	4	8	5.38	14	65	8
4BSP 100 206 S10	1/4", 3/8"	19	4	4	10	5.38	20.6	75	10
4BSP 120 265 S12	1/2", 5/8", 3/4"	14	4	4	12	7.29	26.5	80	12
4BSP 140 260 S14	3/8"	19	4	4	14	5.38	26	85	14
4BSP 140 334 S16	1/2", 5/8", 3/4", 7/8"	14	4	4	16	7.29	33.4	95	16
4BSP 160 380 S16	1", 1 1/4", 1 1/2", 2"	11	4	4	16	9.27	38	105	16
4BSP 160 517 S16	1", 1 1/4", 1 1/2", 2", 2 1/2"	11	4	4	16	9.27	51.7	120	16

Order Number	나사 가능 규격 Thread	피치 규격 Pitch (TPI)	날수 Flutes Z	산수 Teeth Zt	날경 Diameter D	나사부 길이 Thread Length L1	유효강 Effective Length L2	전강 Overall Length L	샙크 Shank Dia d
내부 급유형 (With coolant)									
4BSP 060 095 S06C	1/16", 1/8"	28	4	4	6	3.66	9.5	60	6
4BSP 060 158 S06C	1/16", 1/8"	28	4	4	6	3.66	15.8	60	6
4BSP 080 140 S08C	1/4", 3/8"	19	4	4	8	5.38	14	65	8
4BSP 100 206 S10C	1/4", 3/8"	19	4	4	10	5.38	20.6	75	10
4BSP 120 265 S12C	1/2", 5/8", 3/4"	14	4	4	12	7.29	26.5	80	12
4BSP 140 260 S14C	3/8"	19	4	4	14	5.38	26	85	14
4BSP 140 334 S16C	1/2", 5/8", 3/4", 7/8"	14	4	4	16	7.29	33.4	95	16
4BSP 160 380 S16C	1", 1 1/4", 1 1/2", 2"	11	4	4	16	9.27	38	105	16
4BSP 160 517 S16C	1", 1 1/4", 1 1/2", 2", 2 1/2"	11	4	4	16	9.27	51.7	120	16

# 4BSPA 4 Flutes Pipe Short Parallel Thread Mills for Aluminum

## 4날 알루미늄 관용 평행 나사 가공 짧은 날 쓰레드밀

- 알루미늄, 알루미늄 합금 등 비철 비금속 가공
- 경화강 내 나사 가공을 위한 견고하고 강력한 날 디자인.
- 향상된 절삭 및 칩제거를 통해 공구 성능을 향상 시킵니다.
- 팁 형상은 절삭 저항을 줄이고 공구 구부림을 억제합니다.
- 오른나사 및 왼나사 작업이 모두 가능합니다.

- Thread mills for Aluminum, Aluminum alloys, non-ferrous, and non-metallic materials
- Rigid and powerful flutes design for inside hardening steel.
- Enhanced threading enables chip removal smoothly to reduce possible breakage of tool inside hole.
- The shape of tip reduces fraction and prevent tool bending.
- Both right and left threading are available.

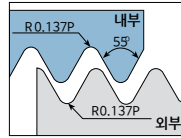
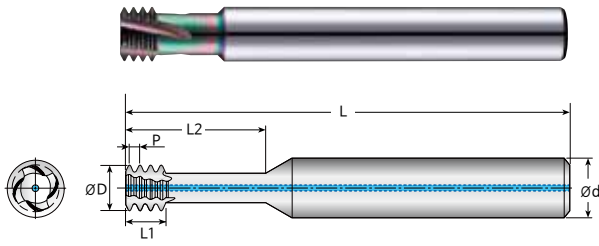

- 규격 정의 : B.S.2779:1956
- 공차 등급 : Medium class

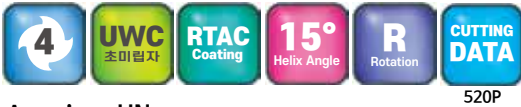

American UN

단위 Unit: mm

Order Number	나사 가능 규격 Thread	피치 규격 Pitch (TPI)	날수 Flutes Z	산수 Teeth Zt	날경 Diameter D	나사부 길이 Thread Length L1	유효장 Effective Length L2	전장 Overall Length L	샙크 Shank Dia d
4BSPA 060 095 S06	1/16", 1/8"	28	4	4	6	3.66	9.5	60	6
4BSPA 060 158 S06	1/16", 1/8"	28	4	4	6	3.66	15.8	60	6
4BSPA 080 140 S08	1/4", 3/8"	19	4	4	8	5.38	14	65	8
4BSPA 100 206 S10	1/4", 3/8"	19	4	4	10	5.38	20.6	75	10
4BSPA 120 265 S12	1/2", 5/8", 3/4"	14	4	4	12	7.29	26.5	80	12
4BSPA 140 260 S14	3/8"	19	4	4	14	5.38	26	85	14
4BSPA 140 334 S16	1/2", 5/8", 3/4", 7/8"	14	4	4	16	7.29	33.4	95	16
4BSPA 160 380 S16	1", 1 1/4", 1 1/2", 2"	11	4	4	16	9.27	38	105	16
4BSPA 160 517 S16	1", 1 1/4", 1 1/2", 2", 2 1/2"	11	4	4	16	9.27	51.7	120	16

외부 급유형 (Without coolant)

Order Number	나사 가능 규격 Thread	피치 규격 Pitch (TPI)	날수 Flutes Z	산수 Teeth Zt	날경 Diameter D	나사부 길이 Thread Length L1	유효장 Effective Length L2	전장 Overall Length L	샙크 Shank Dia d
4BSPA 060 095 S06C	1/16", 1/8"	28	4	4	6	3.66	9.5	60	6
4BSPA 060 158 S06C	1/16", 1/8"	28	4	4	6	3.66	15.8	60	6
4BSPA 080 140 S08C	1/4", 3/8"	19	4	4	8	5.38	14	65	8
4BSPA 100 206 S10C	1/4", 3/8"	19	4	4	10	5.38	20.6	75	10
4BSPA 120 265 S12C	1/2", 5/8", 3/4"	14	4	4	12	7.29	26.5	80	12
4BSPA 140 260 S14C	3/8"	19	4	4	14	5.38	26	85	14
4BSPA 140 334 S16C	1/2", 5/8", 3/4", 7/8"	14	4	4	16	7.29	33.4	95	16
4BSPA 160 380 S16C	1", 1 1/4", 1 1/2", 2"	11	4	4	16	9.27	38	105	16
4BSPA 160 517 S16C	1", 1 1/4", 1 1/2", 2", 2 1/2"	11	4	4	16	9.27	51.7	120	16

내부 급유형 (With coolant)

THREAD MILL

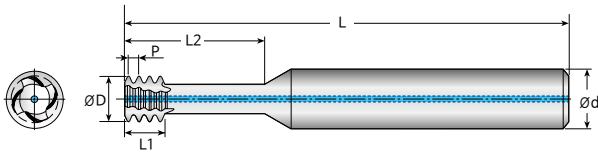

#### SUS, 티타늄 합금 가공

- 경화강 내 나사 가공을 위한 견고하고 강력한 날 디자인.
- 향상된 절삭 및 칩 제거를 통해 공구 성능을 향상 시킵니다.
- 팁 형상은 절삭 저항을 줄이고 공구 구부림을 억제합니다.
- 오른나사 및 왼나사 작업이 모두 가능합니다.

#### Thread mills for SUS and Titanium alloys

- Rigid and powerful flutes design for inside hardening steel.
- Enhanced threading enables chip removal smoothly to reduce possible breakage of tool inside hole.
- The shape of tip reduces friction and prevent tool bending.
- Both right and left threading are available.

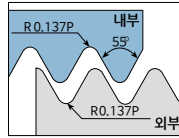

- 규격 정의 : B.S.2779:1956
- 공차 등급 : Medium class

4

UWC  
초미립자

HR  
Coating

15°  
Helix Angle

R  
Rotation

CUTTING  
DATA

520P

American UN

단위 Unit: mm

Order Number	나사 가능 규격 Thread	피치 규격 Pitch (TPI)	날수 Flutes Z	산수 Teeth Zt	날경 Diameter D	나사부 길이 Thread Length L1	유효장 Effective Length L2	전장 Overall Length L	샙크 Shank Dia d
<b>외부 급유형 (Without coolant)</b>									
4BSPS 060 095 S06	1/16", 1/8"	28	4	4	6	3.66	9.5	60	6
4BSPS 060 158 S06	1/16", 1/8"	28	4	4	6	3.66	15.8	60	6
4BSPS 080 140 S08	1/4", 3/8"	19	4	4	8	5.38	14	65	8
4BSPS 100 206 S10	1/4", 3/8"	19	4	4	10	5.38	20.6	75	10
4BSPS 120 265 S12	1/2", 5/8", 3/4"	14	4	4	12	7.29	26.5	80	12
4BSPS 140 260 S14	3/8"	19	4	4	14	5.38	26	85	14
4BSPS 140 334 S16	1/2", 5/8", 3/4", 7/8"	14	4	4	16	7.29	33.4	95	16
4BSPS 160 380 S16	1", 1 1/4", 1 1/2", 2"	11	4	4	16	9.27	38	105	16
4BSPS 160 517 S16	1", 1 1/4", 1 1/2", 2", 2 1/2"	11	4	4	16	9.27	51.7	120	16

<b>내부 급유형 (With coolant)</b>									
4BSPS 060 095 S06C	1/16", 1/8"	28	4	4	6	3.66	9.5	60	6
4BSPS 060 158 S06C	1/16", 1/8"	28	4	4	6	3.66	15.8	60	6
4BSPS 080 140 S08C	1/4", 3/8"	19	4	4	8	5.38	14	65	8
4BSPS 100 206 S10C	1/4", 3/8"	19	4	4	10	5.38	20.6	75	10
4BSPS 120 265 S12C	1/2", 5/8", 3/4"	14	4	4	12	7.29	26.5	80	12
4BSPS 140 260 S14C	3/8"	19	4	4	14	5.38	26	85	14
4BSPS 140 334 S16C	1/2", 5/8", 3/4", 7/8"	14	4	4	16	7.29	33.4	95	16
4BSPS 160 380 S16C	1", 1 1/4", 1 1/2", 2"	11	4	4	16	9.27	38	105	16
4BSPS 160 517 S16C	1", 1 1/4", 1 1/2", 2", 2 1/2"	11	4	4	16	9.27	51.7	120	16

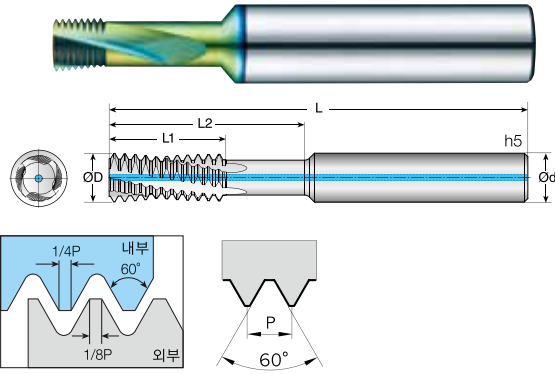

- HRc 48이하의 고경도강, 프리하든강, 합금강, 탄소강, 주철 가공
- 깊은 나사 가공을 위한 쿨런트 타입 헬릭컬 날
- 다중 날 로 구성되어 한번에 여러 나사산 생성으로 시간단축이 가능합니다.
- 최대 나사 가공깊이 : 3xD2 (나사가공 직경)
- 헬리코일 나사 가공이 가능합니다.
- 오른나사 및 왼나사 작업이 모두 가능합니다.
- Thread mills for Hardened steel (up to HRc 48), pre-hardened steels, alloy steels, carbon steels, cast irons
- Coolant type of helix flutes for deep threading.
- With multiple flutes composition, it shortens threading time.
- Maximum drilling depth: 3\*D2 (Threading diameter)
- It can be used for heli coil threading.
- Both right and left threading are available.



ISO 측정항목

521P

단위 Unit: mm

Order Number	피치 규격		기초홀 직경 Guide Hole mm	날경 Diameter D	나사부 길이 Thread Length L1	유효장 Effective Length L2	전장 Overall Length L	생크 Shank Dia d
	Thread	Pitch						
4HTM 024 090 S04 M3	M3	0.5	2.5	2.4	4.7	9	45	4
4HTM 0315 120 S04 M4	M4	0.7	3.3	3.15	6.6	12	45	4
4HTM 039 150 S04 M5	M5	0.8	4.2	3.9	7.6	15	50	4
4HTM 048 180 S06 M6	M6	1	5	4.8	9.5	18	60	6
4HTM 065 240 S08 M8	M8	1.25	6.8	6.5	13.1	24	65	8
4HTM 082 300 S10 M10	M10	1.5	8.5	8.2	15.7	30	75	10
4HTM 099 360 S10 M12	M12	1.75	10.2	9.9	18.4	36	85	10
4HTM 116 420 S12 M14	M14	2	12	11.6	21	42	90	12
4HTM 136 480 S14 M16	M16	2	14	13.6	25	48	100	14

외부 급유형 (Without coolant)

내부 급유형 (With coolant)								
Order Number	피치 규격		기초홀 직경 Guide Hole mm	날경 Diameter D	나사부 길이 Thread Length L1	유효장 Effective Length L2	전장 Overall Length L	생크 Shank Dia d
	Thread	Pitch						
4HTM 024 090 S04 M3C	M3	0.5	2.5	2.4	4.7	9	45	4
4HTM 0315 120 S04 M4C	M4	0.7	3.3	3.15	6.6	12	45	4
4HTM 039 150 S04 M5C	M5	0.8	4.2	3.9	7.6	15	50	4
4HTM 048 180 S06 M6C	M6	1	5	4.8	9.5	18	60	6
4HTM 065 240 S08 M8C	M8	1.25	6.8	6.5	13.1	24	65	8
4HTM 082 300 S10 M10C	M10	1.5	8.5	8.2	15.7	30	75	10
4HTM 099 360 S10 M12C	M12	1.75	10.2	9.9	18.4	36	85	10
4HTM 116 420 S12 M14C	M14	2	12	11.6	21	42	90	12
4HTM 136 480 S14 M16C	M16	2	14	13.6	25	48	100	14



American UN

단위 Unit: mm

Order Number	피치 규격 Thread			날경 Diameter D	나사부 길이 Thread Length L1	나사 산수 Number of threads	유효장 Effective Length L2	전장 Overall Length L	생크 Shank Dia d
	UNC	UNF	Pitch						
<b>외부 급유형 (Without coolant)</b>									
4HTM 0358 1585 S04	No.10-24		24	3.58	8.46	8	15.85	45	4
4HTM 0414 1798 S06	No.12-24		24	4.14	9.6	9	17.98	65	6
4HTM 0488 1905 S06	1/4" x 20		20	4.88	10.21	8	19.05	65	6
4HTM 0516 1905 S06		1/4" x 28	28	5.16	10.01	11	19.05	65	6
4HTM 0615 2398 S08	5/16" x 18		18	6.15	12.7	9	23.98	65	8
4HTM 0765 3018 S08	3/8" x 16		16	7.65	15.9	10	30.18	65	8
4HTM 0899 3444 S10	7/16" x 14		14	8.99	18.16	10	34.44	75	10
4HTM 1034 4105 S12	1/2" x 13		13	10.34	19.58	10	41.05	80	12
4HTM 1181 4445 S12	9/16" x 12		12	11.81	23.29	11	44.45	80	12

<b>내부 급유형 (With coolant)</b>									
4HTM 0358 1585 S04C	No.10-24		24	3.58	8.46	8	15.85	45	4
4HTM 0414 1798 S06C	No.12-24		24	4.14	9.6	9	17.98	65	6
4HTM 0488 1905 S06C	1/4" x 20		20	4.88	10.21	8	19.05	65	6
4HTM 0516 1905 S06C		1/4" x 28	28	5.16	10.01	11	19.05	65	6
4HTM 0615 2398 S08C	5/16" x 18		18	6.15	12.7	9	23.98	65	8
4HTM 0765 3018 S08C	3/8" x 16		16	7.65	15.9	10	30.18	65	8
4HTM 0899 3444 S10C	7/16" x 14		14	8.99	18.16	10	34.44	75	10
4HTM 1034 4105 S12C	1/2" x 13		13	10.34	19.58	10	41.05	80	12
4HTM 1181 4445 S12C	9/16" x 12		12	11.81	23.29	11	44.45	80	12

THREAD MILL

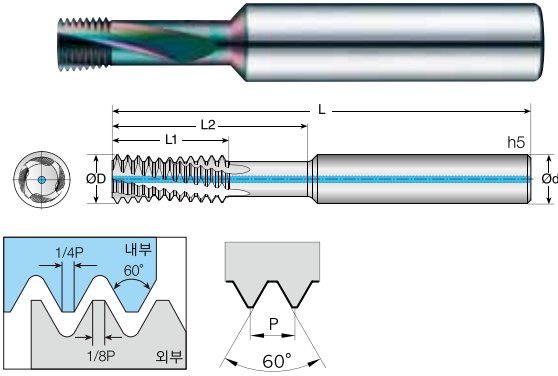

- 알루미늄, 알루미늄 합금 등 비철 비금속 가공
  - 깊은 나사 가공을 위한 쿨런트 타입 헬릭스 날
  - 다중 날 로 구성되어 한번에 여러 나사산 생성으로 시간단축이 가능합니다.
  - 최대 나사 가공깊이 : 3xD2 (나사가공 직경)
  - 헬리코일 나사 가공이 가능합니다.
  - 오른나사 및 왼나사 작업이 모두 가능합니다.
- Thread Mills for Aluminum, Aluminum alloys, non-ferrous and non-metallic materials
  - Coolant type of helix flutes for deep threading.
  - With multiple flutes composition, it shortens threading time.
  - Maximum drilling depth: 3\*D2 (Threading diameter)
  - It can be used for heli coil threading.
  - Both right and left threading are available.



521P

ISO 측정항목

단위 Unit: mm

Order Number	피치 규격		기초홀 직경 Guide Hole mm	날경 Diameter D	나사부 길이 Thread Length L1	유효장 Effective Length L2	전장 Overall Length L	생크 Shank Dia d
	Thread	Pitch						
4HTMA 024 090 S04 M3	M3	0.5	2.5	2.4	4.7	9	45	4
4HTMA 0315 120 S04 M4	M4	0.7	3.3	3.15	6.6	12	45	4
4HTMA 039 150 S04 M5	M5	0.8	4.2	3.9	7.6	15	50	4
4HTMA 048 180 S06 M6	M6	1	5	4.8	9.5	18	60	6
4HTMA 065 240 S08 M8	M8	1.25	6.8	6.5	13.1	24	65	8
4HTMA 082 300 S10 M10	M10	1.5	8.5	8.2	15.7	30	75	10
4HTMA 099 360 S10 M12	M12	1.75	10.2	9.9	18.4	36	85	10
4HTMA 116 420 S12 M14	M14	2	12	11.6	21	42	90	12
4HTMA 136 480 S14 M16	M16	2	14	13.6	25	48	100	14

외부 급유형 (Without coolant)

내부 급유형 (With coolant)								
Order Number	Thread	Pitch	기초홀 직경 Guide Hole mm	날경 Diameter D	나사부 길이 Thread Length L1	유효장 Effective Length L2	전장 Overall Length L	생크 Shank Dia d
4HTMA 024 090 S04 M3C	M3	0.5	2.5	2.4	4.7	9	45	4
4HTMA 0315 120 S04 M4C	M4	0.7	3.3	3.15	6.6	12	45	4
4HTMA 039 150 S04 M5C	M5	0.8	4.2	3.9	7.6	15	50	4
4HTMA 048 180 S06 M6C	M6	1	5	4.8	9.5	18	60	6
4HTMA 065 240 S08 M8C	M8	1.25	6.8	6.5	13.1	24	65	8
4HTMA 082 300 S10 M10C	M10	1.5	8.5	8.2	15.7	30	75	10
4HTMA 099 360 S10 M12C	M12	1.75	10.2	9.9	18.4	36	85	10
4HTMA 116 420 S12 M14C	M14	2	12	11.6	21	42	90	12
4HTMA 136 480 S14 M16C	M16	2	14	13.6	25	48	100	14





American UN

단위 Unit: mm

Order Number	피치 규격 Thread			날경 Diameter D	나사부 길이 Thread Length L1	나사 산수 Number of threads	유효장 Effective Length L2	전장 Overall Length L	생크 Shank Dia d
	UNC	UNF	Pitch						
<b>외부 급유형 (Without coolant)</b>									
4HTMA 0358 1585 S04	No.10-24		24	3.58	8.46	8	15.85	45	4
4HTMA 0414 1798 S06	No.12-24		24	4.14	9.6	9	17.98	65	6
4HTMA 0488 1905 S06	1/4" x 20		20	4.88	10.21	8	19.05	65	6
4HTMA 0516 1905 S06		1/4" x 28	28	5.16	10.01	11	19.05	65	6
4HTMA 0615 2398 S08	5/16" x 18		18	6.15	12.7	9	23.98	65	8
4HTMA 0765 3018 S08	3/8" x 16		16	7.65	15.9	10	30.18	65	8
4HTMA 0899 3444 S10	7/16 x 14		14	8.99	18.16	10	34.44	75	10
4HTMA 1034 4105 S12	1/2" x 13		13	10.34	19.58	10	41.05	80	12
4HTMA 1181 4445 S12	9/16" x 12		12	11.81	23.29	11	44.45	80	12

<b>내부 급유형 (With coolant)</b>									
4HTMA 0358 1585 S04C	No.10-24		24	3.58	8.46	8	15.85	45	4
4HTMA 0414 1798 S06C	No.12-24		24	4.14	9.6	9	17.98	65	6
4HTMA 0488 1905 S06C	1/4" x 20		20	4.88	10.21	8	19.05	65	6
4HTMA 0516 1905 S06C		1/4" x 28	28	5.16	10.01	11	19.05	65	6
4HTMA 0615 2398 S08C	5/16" x 18		18	6.15	12.7	9	23.98	65	8
4HTMA 0765 3018 S08C	3/8" x 16		16	7.65	15.9	10	30.18	65	8
4HTMA 0899 3444 S10C	7/16 x 14		14	8.99	18.16	10	34.44	75	10
4HTMA 1034 4105 S12C	1/2" x 13		13	10.34	19.58	10	41.05	80	12
4HTMA 1181 4445 S12C	9/16" x 12		12	11.81	23.29	11	44.45	80	12

THREAD MILL

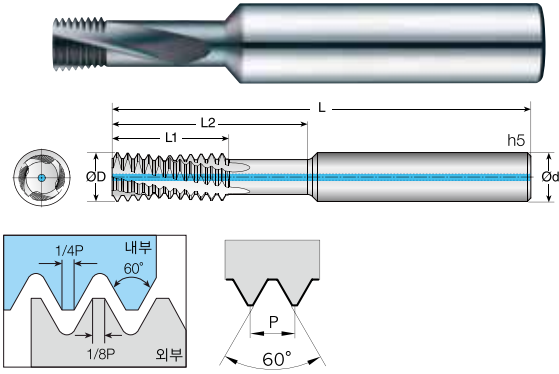

- SUS, 티타늄 합금 가공
  - 깊은 나사 가공을 위한 쿨런트 타입 헬릭컬 날
  - 다중 날로 구성되어 한번에 여러 나사산 생성으로 시간단축이 가능합니다.
  - 최대 나사 가공깊이 : 3xD2 (나사가공 직경)
  - 헬리코일 나사 가공이 가능합니다.
  - 오른나사 및 왼나사 작업이 모두 가능합니다.
- Thread Mills for SUS, Titanium alloys
  - Coolant type of helix flutes for deep threading.
  - With multiple flutes composition, it shortens threading time.
  - Maximum drilling depth: 3\*D2 (Threading diameter)
  - It can be used for heli coil threading.
  - Both right and left threading are available.



521P

ISO 측정항목

단위 Unit: mm

Order Number	피치 규격		기초홀 직경 Guide Hole mm	날경 Diameter D	나사부 길이 Thread Length L1	유효장 Effective Length L2	전장 Overall Length L	생크 Shank Dia d
	Thread	Pitch						
외부 급유형 (Without coolant)								
4HTMS 024 090 S04 M3	M3	0.5	2.5	2.4	4.7	9	45	4
4HTMS 0315 120 S04 M4	M4	0.7	3.3	3.15	6.6	12	45	4
4HTMS 039 150 S04 M5	M5	0.8	4.2	3.9	7.6	15	50	4
4HTMS 048 180 S06 M6	M6	1	5	4.8	9.5	18	60	6
4HTMS 065 240 S08 M8	M8	1.25	6.8	6.5	13.1	24	65	8
4HTMS 082 300 S10 M10	M10	1.5	8.5	8.2	15.7	30	75	10
4HTMS 099 360 S10 M12	M12	1.75	10.2	9.9	18.4	36	85	10
4HTMS 116 420 S12 M14	M14	2	12	11.6	21	42	90	12
4HTMS 136 480 S14 M16	M16	2	14	13.6	25	48	100	14

내부 급유형 (With coolant)								
4HTMS 024 090 S04 M3C	M3	0.5	2.5	2.4	4.7	9	45	4
4HTMS 0315 120 S04 M4C	M4	0.7	3.3	3.15	6.6	12	45	4
4HTMS 039 150 S04 M5C	M5	0.8	4.2	3.9	7.6	15	50	4
4HTMS 048 180 S06 M6C	M6	1	5	4.8	9.5	18	60	6
4HTMS 065 240 S08 M8C	M8	1.25	6.8	6.5	13.1	24	65	8
4HTMS 082 300 S10 M10C	M10	1.5	8.5	8.2	15.7	30	75	10
4HTMS 099 360 S10 M12C	M12	1.75	10.2	9.9	18.4	36	85	10
4HTMS 116 420 S12 M14C	M14	2	12	11.6	21	42	90	12
4HTMS 136 480 S14 M16C	M16	2	14	13.6	25	48	100	14

### American UN

단위 Unit: mm

Order Number	피치 규격 Thread			날경 Diameter D	나사부 길이 Thread Length L1	나사 산수 Number of threads	유효장 Effective Length L2	전장 Overall Length L	생크 Shank Dia d
	UNC	UNF	Pitch						
4HTMS 0358 1585 S04	No.10-24		24	3.58	8.46	8	15.85	45	4
4HTMS 0414 1798 S06	No.12-24		24	4.14	9.6	9	17.98	65	6
4HTMS 0488 1905 S06	1/4" x 20		20	4.88	10.21	8	19.05	65	6
4HTMS 0516 1905 S06		1/4" x 28	28	5.16	10.01	11	19.05	65	6
4HTMS 0615 2398 S08	5/16" x 18		18	6.15	12.7	9	23.98	65	8
4HTMS 0765 3018 S08	3/8" x 16		16	7.65	15.9	10	30.18	65	8
4HTMS 0899 3444 S10	7/16" x 14		14	8.99	18.16	10	34.44	75	10
4HTMS 1034 4105 S12	1/2" x 13		13	10.34	19.58	10	41.05	80	12
4HTMS 1181 4445 S12	9/16" x 12		12	11.81	23.29	11	44.45	80	12

외부 급유형 (Without coolant)

내부 급유형 (With coolant)									
4HTMS 0358 1585 S04C	No.10-24		24	3.58	8.46	8	15.85	45	4
4HTMS 0414 1798 S06C	No.12-24		24	4.14	9.6	9	17.98	65	6
4HTMS 0488 1905 S06C	1/4" x 20		20	4.88	10.21	8	19.05	65	6
4HTMS 0516 1905 S06C		1/4" x 28	28	5.16	10.01	11	19.05	65	6
4HTMS 0615 2398 S08C	5/16" x 18		18	6.15	12.7	9	23.98	65	8
4HTMS 0765 3018 S08C	3/8" x 16		16	7.65	15.9	10	30.18	65	8
4HTMS 0899 3444 S10C	7/16" x 14		14	8.99	18.16	10	34.44	75	10
4HTMS 1034 4105 S12C	1/2" x 13		13	10.34	19.58	10	41.05	80	12
4HTMS 1181 4445 S12C	9/16" x 12		12	11.81	23.29	11	44.45	80	12

내부 급유형 (With coolant)

# 4HBSP

4 Flutes Pipe Parallel Thread Mills for Multi Purpose

## 4날 범용 관용 평행 나사 가공 쓰레드밀

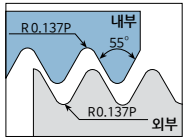
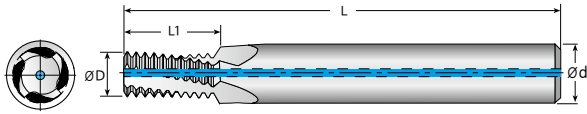

- 규격 정의 : B.S.2779:1956
- 공차 등급 : Medium class



520P

American UN

단위 Unit: mm

Order Number	나사 가능 규격 Thread	피치 규격 Pitch (TPI)	날수 Flutes Z	산수 Teeth Zt	날경 Diameter D	나사부 길이 Thread Length L1	전장 Overall Length L	샙크 Shank Dia d
--------------	--------------------	----------------------	----------------	----------------	------------------	----------------------------	------------------------	-------------------

### 외부 급유형 (Without coolant)

4HBSP 060 0942 S06	1/16", 1/8"	28	4	10	6	9.42	60	6
New 4HBSP 060 1577 S06	1/16", 1/8"	28	4	17	6	15.77	60	6
4HBSP 080 1387 S08	1/4", 3/8"	19	4	10	8	13.87	65	8
New 4HBSP 100 2055 S10	1/4", 3/8"	19	4	15	10	20.55	75	10
4HBSP 120 1882 S12	1/2", 5/8", 3/4"	14	4	10	12	18.82	80	12
New 4HBSP 140 259 S14	3/8"	19	4	19	14	25.9	85	14
4HBSP 160 378 S16	1", 1 1/4", 1 1/2", 2"	11	4	16	16	37.8	105	16
New 4HBSP 160 3333 S16	1/2", 5/8", 3/4", 7/8"	14	4	18	16	33.33	95	16
New 4HBSP 160 5165 S16	1", 1 1/4", 1 1/2", 2", 2 1/2"	11	4	22	16	51.65	120	16

### 내부 급유형 (With coolant)

4HBSP 060 0942 S06C	1/16", 1/8"	28	4	10	6	9.42	60	6
New 4HBSP 060 1577 S06C	1/16", 1/8"	28	4	17	6	15.77	60	6
4HBSP 080 1387 S08C	1/4", 3/8"	19	4	10	8	13.87	65	8
New 4HBSP 100 2055 S10C	1/4", 3/8"	19	4	15	10	20.55	75	10
4HBSP 120 1882 S12C	1/2", 5/8", 3/4"	14	4	10	12	18.82	80	12
New 4HBSP 140 259 S14C	3/8"	19	4	19	14	25.9	85	14
4HBSP 160 378 S16C	1", 1 1/4", 1 1/2", 2"	11	4	16	16	37.8	105	16
New 4HBSP 160 3333 S16C	1/2", 5/8", 3/4", 7/8"	14	4	18	16	33.33	95	16
New 4HBSP 160 5165 S16C	1", 1 1/4", 1 1/2", 2", 2 1/2"	11	4	22	16	51.65	120	16

# 4HBSPA

4 Flutes Pipe Parallel Thread Mills for Aluminum

## 4날 알루미늄 관용 평행 나사 가공 쓰레드밀

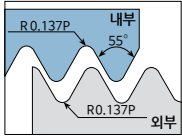
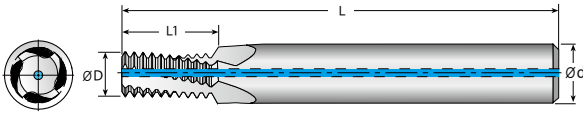

- 규격 정의 : B.S.2779:1956
- 공차 등급 : Medium class



520P

American UN

단위 Unit: mm

Order Number	나사 가능 규격 Thread	피치 규격 Pitch (TPI)	날수 Flutes Z	산수 Teeth Zt	날경 Diameter D	나사부 길이 Thread Length L1	전장 Overall Length L	샙크 Shank Dia d
4HBSPA 060 0942 S06	1/16", 1/8"	28	4	10	6	9.42	60	6
<b>New</b> 4HBSPA 060 1577 S06	1/16", 1/8"	28	4	17	6	15.77	60	6
4HBSPA 080 1387 S08	1/4", 3/8"	19	4	10	8	13.87	65	8
<b>New</b> 4HBSPA 100 2055 S10	1/4", 3/8"	19	4	15	10	20.55	75	10
4HBSPA 120 1882 S12	1/2", 5/8", 3/4"	14	4	10	12	18.82	80	12
<b>New</b> 4HBSPA 140 259 S14	3/8"	19	4	19	14	25.9	85	14
4HBSPA 160 378 S16	1", 1 1/4", 1 1/2", 2"	11	4	16	16	37.8	105	16
<b>New</b> 4HBSPA 160 3333 S16	1/2", 5/8", 3/4", 7/8"	14	4	18	16	33.33	95	16
<b>New</b> 4HBSPA 160 5165 S16	1", 1 1/4", 1 1/2", 2", 2 1/2"	11	4	22	16	51.65	120	16

### 외부 급유형 (Without coolant)

### 내부 급유형 (With coolant)

4HBSPA 060 0942 S06C	1/16", 1/8"	28	4	10	6	9.42	60	6
<b>New</b> 4HBSPA 060 1577 S06C	1/16", 1/8"	28	4	17	6	15.77	60	6
4HBSPA 080 1387 S08C	1/4", 3/8"	19	4	10	8	13.87	65	8
<b>New</b> 4HBSPA 100 2055 S10C	1/4", 3/8"	19	4	15	10	20.55	75	10
4HBSPA 120 1882 S12C	1/2", 5/8", 3/4"	14	4	10	12	18.82	80	12
<b>New</b> 4HBSPA 140 259 S14C	3/8"	19	4	19	14	25.9	85	14
4HBSPA 160 378 S16C	1", 1 1/4", 1 1/2", 2"	11	4	16	16	37.8	105	16
<b>New</b> 4HBSPA 160 3333 S16C	1/2", 5/8", 3/4", 7/8"	14	4	18	16	33.33	95	16
<b>New</b> 4HBSPA 160 5165 S16C	1", 1 1/4", 1 1/2", 2", 2 1/2"	11	4	22	16	51.65	120	16

# 4HBSPS

4 Flutes Pipe Parallel Thread Mills for Stainless Steels

## 4날 SUS 관용 평행 나사 가공 쓰레드밀

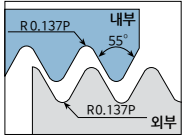
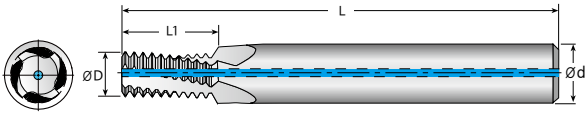

- 규격 정의 : B.S.2779:1956
- 공차 등급 : Medium class

4 UWC Coating HR 15° Helix Angle R Rotation CUTTING DATA 520P

American UN

단위 Unit: mm

Order Number	나사 가능 규격 Thread	피치 규격 Pitch (TPI)	날수 Flutes Z	산수 Teeth Zt	날경 Diameter D	나사부 길이 Thread Length L1	전장 Overall Length L	샙크 Shank Dia d
--------------	--------------------	----------------------	-------------------	-------------------	---------------------	-------------------------------	---------------------------	----------------------

### 외부 급유형 (Without coolant)

4HBSPS 060 0942 S06	1/16", 1/8"	28	4	10	6	9.42	60	6
New 4HBSPS 060 1577 S06	1/16", 1/8"	28	4	17	6	15.77	60	6
4HBSPS 080 1387 S08	1/4", 3/8"	19	4	10	8	13.87	65	8
New 4HBSPS 100 2055 S10	1/4", 3/8"	19	4	15	10	20.55	75	10
4HBSPS 120 1882 S12	1/2", 5/8", 3/4"	14	4	10	12	18.82	80	12
New 4HBSPS 140 259 S14	3/8"	19	4	19	14	25.9	85	14
4HBSPS 160 378 S16	1", 1 1/4", 1 1/2", 2"	11	4	16	16	37.8	105	16
New 4HBSPS 160 3333 S16	1/2", 5/8", 3/4", 7/8"	14	4	18	16	33.33	95	16
New 4HBSPS 160 5165 S16	1", 1 1/4", 1 1/2", 2", 2 1/2"	11	4	22	16	51.65	120	16

### 내부 급유형 (With coolant)

4HBSPS 060 0942 S06C	1/16", 1/8"	28	4	10	6	9.42	60	6
New 4HBSPS 060 1577 S06C	1/16", 1/8"	28	4	17	6	15.77	60	6
4HBSPS 080 1387 S08C	1/4", 3/8"	19	4	10	8	13.87	65	8
New 4HBSPS 100 2055 S10C	1/4", 3/8"	19	4	15	10	20.55	75	10
4HBSPS 120 1882 S12C	1/2", 5/8", 3/4"	14	4	10	12	18.82	80	12
New 4HBSPS 140 259 S14C	3/8"	19	4	19	14	25.9	85	14
4HBSPS 160 378 S16C	1", 1 1/4", 1 1/2", 2"	11	4	16	16	37.8	105	16
New 4HBSPS 160 3333 S16C	1/2", 5/8", 3/4", 7/8"	14	4	18	16	33.33	95	16
New 4HBSPS 160 5165 S16C	1", 1 1/4", 1 1/2", 2", 2 1/2"	11	4	22	16	51.65	120	16

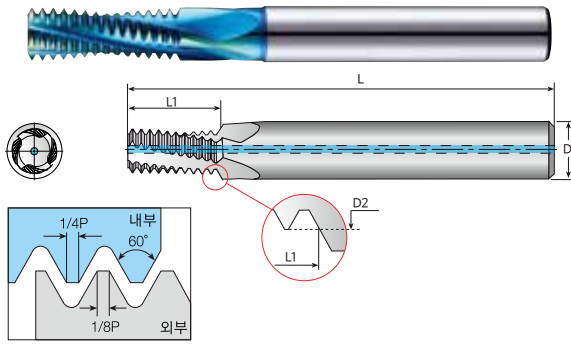

• 규격 범위 : R262 (DN 13)  
• 공차 등급 : 6H



521P

ISO 측정항목

단위 Unit: mm

Order Number	피치 규격		날수 Flutes Z	날경 Diameter D	나사부 길이 Thread Length L1	전장 Overall Length L	샙크 Shank Dia d
	Thread	Pitch					

외부 급유형 (Without coolant)

4LTM 022 060 S06 M3	M3	0.5	4	2.2	6	60	6
4LTM 022 075 S06 M3	M3	0.5	4	2.2	7.5	60	6
4LTM 029 084 S06 M4	M4	0.7	4	2.9	8.4	60	6
4LTM 029 105 S06 M4	M4	0.7	4	2.9	10.5	60	6
4LTM 038 104 S06 M5	M5	0.8	4	3.8	10.4	60	6
4LTM 038 128 S06 M5	M5	0.8	4	3.8	12.8	60	6
4LTM 045 120 S06 M6	M6	1	4	4.5	12	60	6
4LTM 045 150 S06 M6	M6	1	4	4.5	15	60	6
4LTM 060 1625 S06 M8	M8	1.25	4	6	16.25	65	6
4LTM 060 200 S06 M8	M8	1.25	4	6	20	65	6
4LTM 075 210 S08 M10	M10	1.5	4	7.5	21	75	8
4LTM 075 255 S08 M10	M10	1.5	4	7.5	25.5	80	8
4LTM 095 245 S10 M12	M12	1.75	4	9.5	24.5	85	10
4LTM 095 315 S10 M12	M12	1.75	4	9.5	31.5	85	10
4LTM 100 280 S10 M14	M14	2	4	10	28	90	10
4LTM 100 360 S10 M14	M14	2	4	10	36	95	10
4LTM 120 320 S12 M16	M16	2	4	12	32	100	12
4LTM 120 400 S12 M16	M16	2	4	12	40	105	12
4LTM 140 375 S14 M18	M18	2.5	4	14	37.5	100	14
4LTM 140 450 S14 M18	M18	2.5	4	14	45	110	14
4LTM 160 400 S16 M20	M20	2.5	4	16	40	110	16
4LTM 160 500 S16 M20	M20	2.5	4	16	50	120	16

내부 급유형 (With coolant)

4LTM 045 120 S06 M6C	M6	1	4	4.5	12	60	6
4LTM 045 150 S06 M6C	M6	1	4	4.5	15	60	6
4LTM 060 1625 S06 M8C	M8	1.25	4	6	16.25	65	6
4LTM 060 200 S06 M8C	M8	1.25	4	6	20	65	6
4LTM 075 210 S08 M10C	M10	1.5	4	7.5	21	75	8
4LTM 075 255 S08 M10C	M10	1.5	4	7.5	25.5	80	8
4LTM 095 245 S10 M12C	M12	1.75	4	9.5	24.5	85	10
4LTM 095 315 S10 M12C	M12	1.75	4	9.5	31.5	85	10
4LTM 100 280 S10 M14C	M14	2	4	10	28	90	10
4LTM 100 360 S10 M14C	M14	2	4	10	36	95	10
4LTM 120 320 S12 M16C	M16	2	4	12	32	100	12
4LTM 120 400 S12 M16C	M16	2	4	12	40	105	12
4LTM 140 375 S14 M18C	M18	2.5	4	14	37.5	100	14
4LTM 140 450 S14 M18C	M18	2.5	4	14	45	110	14
4LTM 160 400 S16 M20C	M20	2.5	4	16	40	110	16
4LTM 160 500 S16 M20C	M20	2.5	4	16	50	120	16



4날 범용 헬릭스 긴 길이 쓰레드밀

American UN

단위 Unit: mm

Order Number	피치규격 Thread			Pitch (TPI)	날수 Flutes Z	산수 Teeth Zt	날경 Diameter D	나사부 길이 Thread Length L1	전장 Overall Length L	샙크 Shank Dia d
	UNC	UNF	UNEF							
<b>외부급유형 (Without coolant)</b>										
4LTM 021 060 S04	No.4, No.5	No.6		40	4	9	2.1	6	45	4
4LTM 021 079 S04	No.4, No.5	No.6		40	4	12	2.1	7.9	45	4
4LTM 0255 075 S04	No.6, No.8	No.10	No.12	32	4	9	2.55	7.5	45	4
4LTM 0255 099 S04	No.6, No.8	No.10	No.12	32	4	12	2.55	9.9	45	4
4LTM 033 088 S04		No.8		36	4	12	3.3	8.8	45	4
4LTM 033 109 S04		No.8		36	4	15	3.3	10.9	45	4
4LTM 0358 099 S04	No.10, No.12	5/16 ~		24	4	9	3.58	9.9	45	4
4LTM 0358 131 S04	No.10, No.12	5/16 ~		24	4	12	3.58	13.1	45	4
4LTM 038 099 S04		No.10	No.12, 5/16 ~	32	4	12	3.8	9.9	45	4
4LTM 038 130 S04		No.10	No.12, 5/16 ~	32	4	16	3.8	13	45	4
4LTM 0415 110 S06	No.12	5/16 ~, 3/8 ~		24	4	10	4.15	11	60	6
4LTM 0415 152 S06	No.12	5/16 ~, 3/8 ~		24	4	14	4.15	15.2	60	6
4LTM 043 112 S06		No.12, 1/4 ~	7/16 ~	28	4	12	4.3	11.2	60	6
4LTM 043 149 S06		No.12, 1/4 ~	7/16 ~	28	4	16	4.3	14.9	60	6
4LTM 044 114 S06			No.12, 1/4 ~, 5/16 ~	32	4	14	4.4	11.4	60	6
4LTM 044 154 S06			No.12, 1/4 ~, 5/16 ~	32	4	19	4.4	15.4	60	6
4LTM 0488 132 S06	1/4 ~	7/16 ~, 1/2 ~		20	4	10	4.88	13.2	60	6
4LTM 0488 170 S06	1/4 ~	7/16 ~, 1/2 ~		20	4	13	4.88	17	60	6
4LTM 0515 131 S06		1/4 ~	7/16 ~, 1/2 ~	28	4	14	5.15	13.1	60	6
4LTM 0515 167 S06		1/4 ~	7/16 ~, 1/2 ~	28	4	18	5.15	16.7	60	6
4LTM 0615 160 S08	5/16 ~	9/16 ~, 5/8 ~		18	4	11	6.15	16	65	8
4LTM 0615 217 S08	5/16 ~	9/16 ~, 5/8 ~		18	4	15	6.15	21.7	75	8
4LTM 0668 163 S08		5/16 ~, 3/8 ~	9/16 ~	24	4	15	6.68	16.3	65	8
4LTM 0668 205 S08		5/16 ~, 3/8 ~	9/16 ~	24	4	19	6.68	20.5	75	8
4LTM 0765 196 S08	3/8 ~	3/4 ~		16	4	12	7.65	19.6	65	8
4LTM 0765 244 S08	3/8 ~	3/4 ~		16	4	15	7.65	24.4	75	8
4LTM 082 195 S10		3/8 ~	9/16 ~, 5/8 ~	24	4	18	8.2	19.5	75	10
4LTM 082 247 S10		3/8 ~	9/16 ~, 5/8 ~	24	4	23	8.2	24.7	80	10
4LTM 090 224 S10	7/16 ~	7/8 ~		14	4	12	9	22.4	75	10
4LTM 090 297 S10	7/16 ~	7/8 ~		14	4	16	9	29.7	80	10
4LTM 096 221 S10		7/16 ~, 1/2 ~	3/4 ~	20	4	17	9.6	22.1	75	10
4LTM 096 284 S10		7/16 ~, 1/2 ~	3/4 ~	20	4	22	9.6	28.4	80	10
4LTM 099 221 S10			7/16 ~, 1/2 ~	28	4	24	9.9	22.1	75	10
4LTM 099 285 S10			7/16 ~, 1/2 ~	28	4	31	9.9	28.5	80	10
4LTM 1035 261 S12	1/2 ~			13	4	13	10.35	26.1	80	12
4LTM 1035 339 S12	1/2 ~			13	4	17	10.35	33.9	90	12
4LTM 111 259 S12		1/2 ~	3/4 ~, 13/16 ~	20	4	20	11.1	25.9	80	12
4LTM 111 322 S12		1/2 ~	3/4 ~, 13/16 ~	20	4	25	11.1	32.2	90	12
4LTM 118 283 S12	9/16 ~	1 ~, 1-1/8 ~		12	4	13	11.8	28.3	80	12
4LTM 118 367 S12	9/16 ~	1 ~, 1-1/8 ~		12	4	17	11.8	36.7	90	12
4LTM 125 287 S14		9/16 ~, 5/8 ~	11/16 ~	18	4	20	12.5	28.7	95	14
4LTM 125 372 S14		9/16 ~, 5/8 ~	11/16 ~	18	4	26	12.5	37.2	100	14
4LTM 129 290 S14			9/16 ~, 5/8 ~, 11/16 ~	24	4	27	12.9	29	95	14
4LTM 129 364 S14			9/16 ~, 5/8 ~, 11/16 ~	24	4	34	12.9	36.4	100	14
4LTM 131 331 S14	5/8 ~			11	4	14	13.1	33.1	95	14
4LTM 131 424 S14	5/8 ~			11	4	18	13.1	42.4	105	14
4LTM 141 316 S16		5/8 ~	11/16 ~, 1-1/8 ~	18	4	22	14.1	31.6	95	16
4LTM 141 414 S16		5/8 ~	11/16 ~, 1-1/8 ~	18	4	29	14.1	41.4	105	16
4LTM 159 390 S16	3/4 ~			10	4	15	15.9	39	100	16
4LTM 159 491 S16	3/4 ~			10	4	19	15.9	49.1	110	16
4LTM 160 387 S16		3/4 ~		16	4	24	16	38.7	105	16
4LTM 160 482 S16		3/4 ~		16	4	30	16	48.2	115	16
4LTM 160 386 S16			3/4 ~, 13/16 ~, 7/8 ~	20	4	30	16	38.6	105	16
4LTM 160 487 S16			3/4 ~, 13/16 ~, 7/8 ~	20	4	38	16	48.7	115	16
4LTM 160 461 S16	7/8 ~			9	4	16	16	46.1	110	16
4LTM 160 442 S16		7/8 ~		14	4	24	16	44.2	110	16
4LTM 160 519 S16	1 ~			8	4	16	16	51.9	120	16
4LTM 160 515 S16		1 ~, 1-1/8 ~, 1-1/2 ~		12	4	24	16	51.5	120	16





4날 범용 헬릭스 긴 길이 쓰레드밀

American UN

단위 Unit: mm

Order Number	피치규격 Thread			Pitch (TPI)	날수 Flutes Z	산수 Teeth Zt	날경 Diameter D	나사부 길이 Thread Length L1	전장 Overall Length L	샙크 Shank Dia d
	UNC	UNF	UNEF							
4LTM 0358 099 S04C	No.10, No.12	5/16 ~		24	4	9	3.58	9.9	45	4
4LTM 0358 131 S04C	No.10, No.12	5/16 ~		24	4	12	3.58	13.1	45	4
4LTM 038 099 S04C		No.10	No.12, 5/16 ~	32	4	12	3.8	9.9	45	4
4LTM 038 130 S04C		No.10	No.12, 5/16 ~	32	4	16	3.8	13	45	4
4LTM 0415 110 S06C	No.12	5/16 ~, 3/8 ~		24	4	10	4.15	11	60	6
4LTM 0415 152 S06C	No.12	5/16 ~, 3/8 ~		24	4	14	4.15	15.2	60	6
4LTM 043 112 S06C		No.12, 1/4 ~	7/16 ~	28	4	12	4.3	11.2	60	6
4LTM 043 149 S06C		No.12, 1/4 ~	7/16 ~	28	4	16	4.3	14.9	60	6
4LTM 044 114 S06C			No.12, 1/4 ~, 5/16 ~	32	4	14	4.4	11.4	60	6
4LTM 044 154 S06C			No.12, 1/4 ~, 5/16 ~	32	4	19	4.4	15.4	60	6
4LTM 0488 132 S06C	1/4 ~	7/16 ~, 1/2 ~		20	4	10	4.88	13.2	60	6
4LTM 0488 170 S06C	1/4 ~	7/16 ~, 1/2 ~		20	4	13	4.88	17	60	6
4LTM 0515 131 S06C		1/4 ~	7/16 ~, 1/2 ~	28	4	14	5.15	13.1	60	6
4LTM 0515 167 S06C		1/4 ~	7/16 ~, 1/2 ~	28	4	18	5.15	16.7	60	6
4LTM 0615 160 S08C	5/16 ~	9/16 ~, 5/8 ~		18	4	11	6.15	16	65	8
4LTM 0615 217 S08C	5/16 ~	9/16 ~, 5/8 ~		18	4	15	6.15	21.7	75	8
4LTM 0668 163 S08C		5/16 ~, 3/8 ~	9/16 ~	24	4	15	6.68	16.3	65	8
4LTM 0668 205 S08C		5/16 ~, 3/8 ~	9/16 ~	24	4	19	6.68	20.5	75	8
4LTM 0765 196 S08C	3/8 ~	3/4 ~		16	4	12	7.65	19.6	65	8
4LTM 0765 244 S08C	3/8 ~	3/4 ~		16	4	15	7.65	24.4	75	8
4LTM 082 195 S10C		3/8 ~	9/16 ~, 5/8 ~	24	4	18	8.2	19.5	75	10
4LTM 082 247 S10C		3/8 ~	9/16 ~, 5/8 ~	24	4	23	8.2	24.7	80	10
4LTM 090 224 S10C	7/16 ~	7/8 ~		14	4	12	9	22.4	75	10
4LTM 090 297 S10C	7/16 ~	7/8 ~		14	4	16	9	29.7	80	10
4LTM 096 221 S10C		7/16 ~, 1/2 ~	3/4 ~	20	4	17	9.6	22.1	75	10
4LTM 096 284 S10C		7/16 ~, 1/2 ~	3/4 ~	20	4	22	9.6	28.4	80	10
4LTM 099 221 S10C			7/16 ~, 1/2 ~	28	4	24	9.9	22.1	75	10
4LTM 099 285 S10C			7/16 ~, 1/2 ~	28	4	31	9.9	28.5	80	10
4LTM 1035 261 S12C	1/2 ~			13	4	13	10.35	26.1	80	12
4LTM 1035 339 S12C	1/2 ~			13	4	17	10.35	33.9	90	12
4LTM 111 259 S12C		1/2 ~	3/4 ~, 13/16 ~	20	4	20	11.1	25.9	80	12
4LTM 111 322 S12C		1/2 ~	3/4 ~, 13/16 ~	20	4	25	11.1	32.2	90	12
4LTM 118 283 S12C	9/16 ~	1 ~, 1-1/8 ~		12	4	13	11.8	28.3	80	12
4LTM 118 367 S12C	9/16 ~	1 ~, 1-1/8 ~		12	4	17	11.8	36.7	90	12
4LTM 125 287 S14C		9/16 ~, 5/8 ~	11/16 ~	18	4	20	12.5	28.7	95	14
4LTM 125 372 S14C		9/16 ~, 5/8 ~	11/16 ~	18	4	26	12.5	37.2	100	14
4LTM 129 290 S14C			9/16 ~, 5/8 ~, 11/16 ~	24	4	27	12.9	29	95	14
4LTM 129 364 S14C			9/16 ~, 5/8 ~, 11/16 ~	24	4	34	12.9	36.4	100	14
4LTM 131 331 S14C	5/8 ~			11	4	14	13.1	33.1	95	14
4LTM 131 424 S14C	5/8 ~			11	4	18	13.1	42.4	105	14
4LTM 141 316 S16C		5/8 ~	11/16 ~, 1-1/8 ~	18	4	22	14.1	31.6	95	16
4LTM 141 414 S16C		5/8 ~	11/16 ~, 1-1/8 ~	18	4	29	14.1	41.4	105	16
4LTM 159 390 S16C	3/4 ~			10	4	15	15.9	39	100	16
4LTM 159 491 S16C	3/4 ~			10	4	19	15.9	49.1	110	16
4LTM 160 387 S16C		3/4 ~		16	4	24	16	38.7	105	16
4LTM 160 482 S16C		3/4 ~		16	4	30	16	48.2	115	16
4LTM 160 386 S16C			3/4 ~, 13/16 ~, 7/8 ~	20	4	30	16	38.6	105	16
4LTM 160 487 S16C			3/4 ~, 13/16 ~, 7/8 ~	20	4	38	16	48.7	115	16
4LTM 160 461 S16C	7/8 ~			9	4	16	16	46.1	110	16
4LTM 160 442 S16C		7/8 ~		14	4	24	16	44.2	110	16
4LTM 160 519 S16C	1 ~			8	4	16	16	51.9	120	16
4LTM 160 515 S16C		1 ~, 1-1/8 ~, 1-1/2 ~		12	4	24	16	51.5	120	16

내부 급유형 (With coolant)

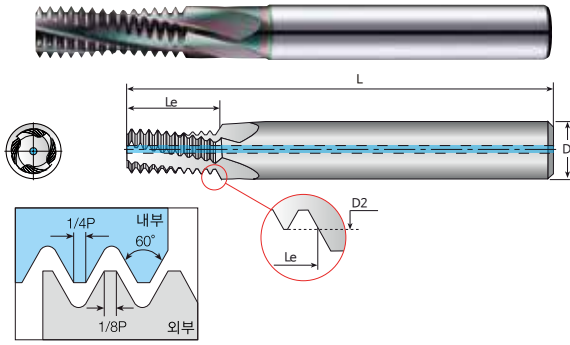

• 규격 정의 : R262 (DN 13)  
• 공차 등급 : 6H



521P

ISO 측정항목

단위 Unit: mm

Order Number	피치 규격		날수 Flutes Z	날경 Diameter D	나사부 길이 Thread Length L1	전장 Overall Length L	샙크 Shank Dia d
	Thread	Pitch					

#### 외부 급유형 (Without coolant)

4LTMA 022 060 S06 M3	M3	0.5	4	2.2	6	60	6
4LTMA 022 075 S06 M3	M3	0.5	4	2.2	7.5	60	6
4LTMA 029 084 S06 M4	M4	0.7	4	2.9	8.4	60	6
4LTMA 029 105 S06 M4	M4	0.7	4	2.9	10.5	60	6
4LTMA 038 104 S06 M5	M5	0.8	4	3.8	10.4	60	6
4LTMA 038 128 S06 M5	M5	0.8	4	3.8	12.8	60	6
4LTMA 045 120 S06 M6	M6	1	4	4.5	12	60	6
4LTMA 045 150 S06 M6	M6	1	4	4.5	15	60	6
4LTMA 060 1625 S06 M8	M8	1.25	4	6	16.25	65	6
4LTMA 060 200 S06 M8	M8	1.25	4	6	20	65	6
4LTMA 075 210 S08 M10	M10	1.5	4	7.5	21	75	8
4LTMA 075 255 S08 M10	M10	1.5	4	7.5	25.5	80	8
4LTMA 095 245 S10 M12	M12	1.75	4	9.5	24.5	85	10
4LTMA 095 315 S10 M12	M12	1.75	4	9.5	31.5	85	10
4LTMA 100 280 S10 M14	M14	2	4	10	28	90	10
4LTMA 100 360 S10 M14	M14	2	4	10	36	95	10
4LTMA 120 320 S12 M16	M16	2	4	12	32	100	12
4LTMA 120 400 S12 M16	M16	2	4	12	40	105	12
4LTMA 140 375 S14 M18	M18	2.5	4	14	37.5	100	14
4LTMA 140 450 S14 M18	M18	2.5	4	14	45	110	14
4LTMA 160 400 S16 M20	M20	2.5	4	16	40	110	16
4LTMA 160 500 S16 M20	M20	2.5	4	16	50	120	16

#### 내부 급유형 (With coolant)

4LTMA 045 120 S06 M6C	M6	1	4	4.5	12	60	6
4LTMA 045 150 S06 M6C	M6	1	4	4.5	15	60	6
4LTMA 060 1625 S06 M8C	M8	1.25	4	6	16.25	65	6
4LTMA 060 200 S06 M8C	M8	1.25	4	6	20	65	6
4LTMA 075 210 S08 M10C	M10	1.5	4	7.5	21	75	8
4LTMA 075 255 S08 M10C	M10	1.5	4	7.5	25.5	80	8
4LTMA 095 245 S10 M12C	M12	1.75	4	9.5	24.5	85	10
4LTMA 095 315 S10 M12C	M12	1.75	4	9.5	31.5	85	10
4LTMA 100 280 S10 M14C	M14	2	4	10	28	90	10
4LTMA 100 360 S10 M14C	M14	2	4	10	36	95	10
4LTMA 120 320 S12 M16C	M16	2	4	12	32	100	12
4LTMA 120 400 S12 M16C	M16	2	4	12	40	105	12
4LTMA 140 375 S14 M18C	M18	2.5	4	14	37.5	100	14
4LTMA 140 450 S14 M18C	M18	2.5	4	14	45	110	14
4LTMA 160 400 S16 M20C	M20	2.5	4	16	40	110	16
4LTMA 160 500 S16 M20C	M20	2.5	4	16	50	120	16

#### American UN

단위 Unit: mm

Order Number	피치규격 Thread			Pitch (TPI)	날수 Flutes Z	산수 Teeth Zt	날경 Diameter D	나사부 길이 Thread Length L1	전장 Overall Length L	샙크 Shank Dia d
	UNC	UNF	UNEF							
<b>외부 급유형 (Without coolant)</b>										
4LTMA 021 060 S04	No.4, No.5	No.6		40	4	9	2.1	6	45	4
4LTMA 021 079 S04	No.4, No.5	No.6		40	4	12	2.1	7.9	45	4
4LTMA 0255 075 S04	No.6, No.8	No.10	No.12	32	4	9	2.55	7.5	45	4
4LTMA 0255 099 S04	No.6, No.8	No.10	No.12	32	4	12	2.55	9.9	45	4
4LTMA 033 088 S04		No.8		36	4	12	3.3	8.8	45	4
4LTMA 033 109 S04		No.8		36	4	15	3.3	10.9	45	4
4LTMA 0358 099 S04	No.10, No.12	5/16"		24	4	9	3.58	9.9	45	4
4LTMA 0358 131 S04	No.10, No.12	5/16"		24	4	12	3.58	13.1	45	4
4LTMA 038 099 S04		No.10	No.12, 5/16"	32	4	12	3.8	9.9	45	4
4LTMA 038 130 S04		No.10	No.12, 5/16"	32	4	16	3.8	13	45	4
4LTMA 0415 110 S06	No.12	5/16", 3/8"		24	4	10	4.15	11	60	6
4LTMA 0415 152 S06	No.12	5/16", 3/8"		24	4	14	4.15	15.2	60	6
4LTMA 043 112 S06		No.12, 1/4"	7/16"	28	4	12	4.3	11.2	60	6
4LTMA 043 149 S06		No.12, 1/4"	7/16"	28	4	16	4.3	14.9	60	6
4LTMA 044 114 S06			No.12, 1/4", 5/16"	32	4	14	4.4	11.4	60	6
4LTMA 044 154 S06			No.12, 1/4", 5/16"	32	4	19	4.4	15.4	60	6
4LTMA 0488 132 S06	1/4"	7/16", 1/2"		20	4	10	4.88	13.2	60	6
4LTMA 0488 170 S06	1/4"	7/16", 1/2"		20	4	13	4.88	17	60	6
4LTMA 0515 131 S06		1/4"	7/16", 1/2"	28	4	14	5.15	13.1	60	6
4LTMA 0515 167 S06		1/4"	7/16", 1/2"	28	4	18	5.15	16.7	60	6
4LTMA 0615 160 S08	5/16"	9/16", 5/8"		18	4	11	6.15	16	65	8
4LTMA 0615 217 S08	5/16"	9/16", 5/8"		18	4	15	6.15	21.7	75	8
4LTMA 0668 163 S08		5/16", 3/8"	9/16"	24	4	15	6.68	16.3	65	8
4LTMA 0668 205 S08		5/16", 3/8"	9/16"	24	4	19	6.68	20.5	75	8
4LTMA 0765 196 S08	3/8"	3/4"		16	4	12	7.65	19.6	65	8
4LTMA 0765 244 S08	3/8"	3/4"		16	4	15	7.65	24.4	75	8
4LTMA 082 195 S10		3/8"	9/16", 5/8"	24	4	18	8.2	19.5	75	10
4LTMA 082 247 S10		3/8"	9/16", 5/8"	24	4	23	8.2	24.7	80	10
4LTMA 090 224 S10	7/16"	7/8"		14	4	12	9	22.4	75	10
4LTMA 090 297 S10	7/16"	7/8"		14	4	16	9	29.7	80	10
4LTMA 096 221 S10		7/16", 1/2"	3/4"	20	4	17	9.6	22.1	75	10
4LTMA 096 284 S10		7/16", 1/2"	3/4"	20	4	22	9.6	28.4	80	10
4LTMA 099 221 S10			7/16", 1/2"	28	4	24	9.9	22.1	75	10
4LTMA 099 285 S10			7/16", 1/2"	28	4	31	9.9	28.5	80	10
4LTMA 1035 261 S12	1/2"			13	4	13	10.35	26.1	80	12
4LTMA 1035 339 S12	1/2"			13	4	17	10.35	33.9	90	12
4LTMA 111 259 S12		1/2"	3/4", 13/16"	20	4	20	11.1	25.9	80	12
4LTMA 111 322 S12		1/2"	3/4", 13/16"	20	4	25	11.1	32.2	90	12
4LTMA 118 283 S12	9/16"	1", 1-1/8"		12	4	13	11.8	28.3	80	12
4LTMA 118 367 S12	9/16"	1", 1-1/8"		12	4	17	11.8	36.7	90	12
4LTMA 125 287 S14		9/16", 5/8"	11/16"	18	4	20	12.5	28.7	95	14
4LTMA 125 372 S14		9/16", 5/8"	11/16"	18	4	26	12.5	37.2	100	14
4LTMA 129 290 S14			9/16", 5/8", 11/16"	24	4	27	12.9	29	95	14
4LTMA 129 364 S14			9/16", 5/8", 11/16"	24	4	34	12.9	36.4	100	14
4LTMA 131 331 S14	5/8"			11	4	14	13.1	33.1	95	14
4LTMA 131 424 S14	5/8"			11	4	18	13.1	42.4	105	14
4LTMA 141 316 S16		5/8"	11/16", 1-1/8"	18	4	22	14.1	31.6	95	16
4LTMA 141 414 S16		5/8"	11/16", 1-1/8"	18	4	29	14.1	41.4	105	16
4LTMA 159 390 S16	3/4"			10	4	15	15.9	39	100	16
4LTMA 159 491 S16	3/4"			10	4	19	15.9	49.1	110	16
4LTMA 160 387 S16		3/4"		16	4	24	16	38.7	105	16
4LTMA 160 482 S16		3/4"		16	4	30	16	48.2	115	16
4LTMA 160 386 S16			3/4", 13/16", 7/8"	20	4	30	16	38.6	105	16
4LTMA 160 487 S16			3/4", 13/16", 7/8"	20	4	38	16	48.7	115	16
4LTMA 160 461 S16	7/8"			9	4	16	16	46.1	110	16
4LTMA 160 442 S16		7/8"		14	4	24	16	44.2	110	16
4LTMA 160 519 S16	1"			8	4	16	16	51.9	120	16
4LTMA 160 515 S16		1", 1-1/8", 1-1/2"		12	4	24	16	51.5	120	16

THREAD MILL

American UN

단위 Unit: mm

Order Number	피치규격 Thread			Pitch (TPI)	날수 Flutes Z	산수 Teeth Zt	날경 Diameter D	나사부 길이 Thread Length L1	전장 Overall Length L	샙크 Shank Dia d
	UNC	UNF	UNEF							
<b>내부 급유형 (With coolant)</b>										
4LTMA 0358 099 S04C	No.10, No.12	5/16 ~		24	4	9	3.58	9.9	45	4
4LTMA 0358 131 S04C	No.10, No.12	5/16 ~		24	4	12	3.58	13.1	45	4
4LTMA 038 099 S04C		No.10	No.12, 5/16 ~	32	4	12	3.8	9.9	45	4
4LTMA 038 130 S04C		No.10	No.12, 5/16 ~	32	4	16	3.8	13	45	4
4LTMA 0415 110 S06C	No.12	5/16 ~, 3/8 ~		24	4	10	4.15	11	60	6
4LTMA 0415 152 S06C	No.12	5/16 ~, 3/8 ~		24	4	14	4.15	15.2	60	6
4LTMA 043 112 S06C		No.12, 1/4 ~	7/16 ~	28	4	12	4.3	11.2	60	6
4LTMA 043 149 S06C		No.12, 1/4 ~	7/16 ~	28	4	16	4.3	14.9	60	6
4LTMA 044 114 S06C			No.12, 1/4 ~, 5/16 ~	32	4	14	4.4	11.4	60	6
4LTMA 044 154 S06C			No.12, 1/4 ~, 5/16 ~	32	4	19	4.4	15.4	60	6
4LTMA 0488 132 S06C	1/4 ~	7/16 ~, 1/2 ~		20	4	10	4.88	13.2	60	6
4LTMA 0488 170 S06C	1/4 ~	7/16 ~, 1/2 ~		20	4	13	4.88	17	60	6
4LTMA 0515 131 S06C		1/4 ~	7/16 ~, 1/2 ~	28	4	14	5.15	13.1	60	6
4LTMA 0515 167 S06C		1/4 ~	7/16 ~, 1/2 ~	28	4	18	5.15	16.7	60	6
4LTMA 0615 160 S08C	5/16 ~	9/16 ~, 5/8 ~		18	4	11	6.15	16	65	8
4LTMA 0615 217 S08C	5/16 ~	9/16 ~, 5/8 ~		18	4	15	6.15	21.7	75	8
4LTMA 0668 163 S08C		5/16 ~, 3/8 ~	9/16 ~	24	4	15	6.68	16.3	65	8
4LTMA 0668 205 S08C		5/16 ~, 3/8 ~	9/16 ~	24	4	19	6.68	20.5	75	8
4LTMA 0765 196 S08C	3/8 ~	3/4 ~		16	4	12	7.65	19.6	65	8
4LTMA 0765 244 S08C	3/8 ~	3/4 ~		16	4	15	7.65	24.4	75	8
4LTMA 082 195 S10C		3/8 ~	9/16 ~, 5/8 ~	24	4	18	8.2	19.5	75	10
4LTMA 082 247 S10C		3/8 ~	9/16 ~, 5/8 ~	24	4	23	8.2	24.7	80	10
4LTMA 090 224 S10C	7/16 ~	7/8 ~		14	4	12	9	22.4	75	10
4LTMA 090 297 S10C	7/16 ~	7/8 ~		14	4	16	9	29.7	80	10
4LTMA 096 221 S10C		7/16 ~, 1/2 ~	3/4 ~	20	4	17	9.6	22.1	75	10
4LTMA 096 284 S10C		7/16 ~, 1/2 ~	3/4 ~	20	4	22	9.6	28.4	80	10
4LTMA 099 221 S10C			7/16 ~, 1/2 ~	28	4	24	9.9	22.1	75	10
4LTMA 099 285 S10C			7/16 ~, 1/2 ~	28	4	31	9.9	28.5	80	10
4LTMA 1035 261 S12C	1/2 ~			13	4	13	10.35	26.1	80	12
4LTMA 1035 339 S12C	1/2 ~			13	4	17	10.35	33.9	90	12
4LTMA 111 259 S12C		1/2 ~	3/4 ~, 13/16 ~	20	4	20	11.1	25.9	80	12
4LTMA 111 322 S12C		1/2 ~	3/4 ~, 13/16 ~	20	4	25	11.1	32.2	90	12
4LTMA 118 283 S12C	9/16 ~	1 ~, 1-1/8 ~		12	4	13	11.8	28.3	80	12
4LTMA 118 367 S12C	9/16 ~	1 ~, 1-1/8 ~		12	4	17	11.8	36.7	90	12
4LTMA 125 287 S14C		9/16 ~, 5/8 ~	11/16 ~	18	4	20	12.5	28.7	95	14
4LTMA 125 372 S14C		9/16 ~, 5/8 ~	11/16 ~	18	4	26	12.5	37.2	100	14
4LTMA 129 290 S14C			9/16 ~, 5/8 ~, 11/16 ~	24	4	27	12.9	29	95	14
4LTMA 129 364 S14C			9/16 ~, 5/8 ~, 11/16 ~	24	4	34	12.9	36.4	100	14
4LTMA 131 331 S14C	5/8 ~			11	4	14	13.1	33.1	95	14
4LTMA 131 424 S14C	5/8 ~			11	4	18	13.1	42.4	105	14
4LTMA 141 316 S16C		5/8 ~	11/16 ~, 1-1/8 ~	18	4	22	14.1	31.6	95	16
4LTMA 141 414 S16C		5/8 ~	11/16 ~, 1-1/8 ~	18	4	29	14.1	41.4	105	16
4LTMA 159 390 S16C	3/4 ~			10	4	15	15.9	39	100	16
4LTMA 159 491 S16C	3/4 ~			10	4	19	15.9	49.1	110	16
4LTMA 160 387 S16C		3/4 ~		16	4	24	16	38.7	105	16
4LTMA 160 482 S16C		3/4 ~		16	4	30	16	48.2	115	16
4LTMA 160 386 S16C			3/4 ~, 13/16 ~, 7/8 ~	20	4	30	16	38.6	105	16
4LTMA 160 487 S16C			3/4 ~, 13/16 ~, 7/8 ~	20	4	38	16	48.7	115	16
4LTMA 160 461 S16C	7/8 ~			9	4	16	16	46.1	110	16
4LTMA 160 442 S16C		7/8 ~		14	4	24	16	44.2	110	16
4LTMA 160 519 S16C	1 ~			8	4	16	16	51.9	120	16
4LTMA 160 515 S16C		1 ~, 1-1/8 ~, 1-1/2 ~		12	4	24	16	51.5	120	16

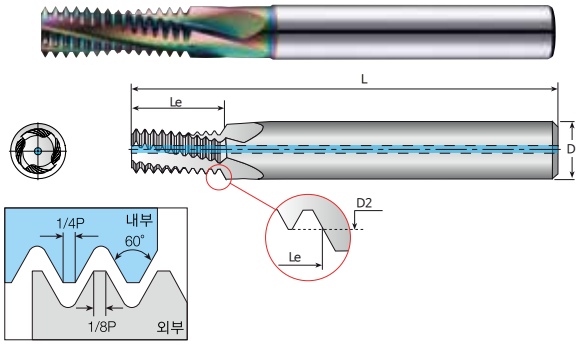

• 규격 정의 : R262 (DN 13)  
• 공차 등급 : 6H



521P

ISO 측정항목

단위 Unit: mm

Order Number	피치 규격		날수 Flutes Z	날경 Diameter D	나사부 길이 Thread Length L1	전장 Overall Length L	샹크 Shank Dia d
	Thread	Pitch					

#### 외부 급유형 (Without coolant)

4LTMS 022 060 S06 M3	M3	0.5	4	2.2	6	60	6
4LTMS 022 075 S06 M3	M3	0.5	4	2.2	7.5	60	6
4LTMS 029 084 S06 M4	M4	0.7	4	2.9	8.4	60	6
4LTMS 029 105 S06 M4	M4	0.7	4	2.9	10.5	60	6
4LTMS 038 104 S06 M5	M5	0.8	4	3.8	10.4	60	6
4LTMS 038 128 S06 M5	M5	0.8	4	3.8	12.8	60	6
4LTMS 045 120 S06 M6	M6	1	4	4.5	12	60	6
4LTMS 045 150 S06 M6	M6	1	4	4.5	15	60	6
4LTMS 060 1625 S06 M8	M8	1.25	4	6	16.25	65	6
4LTMS 060 200 S06 M8	M8	1.25	4	6	20	65	6
4LTMS 075 210 S08 M10	M10	1.5	4	7.5	21	75	8
4LTMS 075 255 S08 M10	M10	1.5	4	7.5	25.5	80	8
4LTMS 095 245 S10 M12	M12	1.75	4	9.5	24.5	85	10
4LTMS 095 315 S10 M12	M12	1.75	4	9.5	31.5	85	10
4LTMS 100 280 S10 M14	M14	2	4	10	28	90	10
4LTMS 100 360 S10 M14	M14	2	4	10	36	95	10
4LTMS 120 320 S12 M16	M16	2	4	12	32	100	12
4LTMS 120 400 S12 M16	M16	2	4	12	40	105	12
4LTMS 140 375 S14 M18	M18	2.5	4	14	37.5	100	14
4LTMS 140 450 S14 M18	M18	2.5	4	14	45	110	14
4LTMS 160 400 S16 M20	M20	2.5	4	16	40	110	16
4LTMS 160 500 S16 M20	M20	2.5	4	16	50	120	16

#### 내부 급유형 (With coolant)

4LTMS 045 120 S06 M6C	M6	1	4	4.5	12	60	6
4LTMS 045 150 S06 M6C	M6	1	4	4.5	15	60	6
4LTMS 060 1625 S06 M8C	M8	1.25	4	6	16.25	65	6
4LTMS 060 200 S06 M8C	M8	1.25	4	6	20	65	6
4LTMS 075 210 S08 M10C	M10	1.5	4	7.5	21	75	8
4LTMS 075 255 S08 M10C	M10	1.5	4	7.5	25.5	80	8
4LTMS 095 245 S10 M12C	M12	1.75	4	9.5	24.5	85	10
4LTMS 095 315 S10 M12C	M12	1.75	4	9.5	31.5	85	10
4LTMS 100 280 S10 M14C	M14	2	4	10	28	90	10
4LTMS 100 360 S10 M14C	M14	2	4	10	36	95	10
4LTMS 120 320 S12 M16C	M16	2	4	12	32	100	12
4LTMS 120 400 S12 M16C	M16	2	4	12	40	105	12
4LTMS 140 375 S14 M18C	M18	2.5	4	14	37.5	100	14
4LTMS 140 450 S14 M18C	M18	2.5	4	14	45	110	14
4LTMS 160 400 S16 M20C	M20	2.5	4	16	40	110	16
4LTMS 160 500 S16 M20C	M20	2.5	4	16	50	120	16

#### American UN

단위 Unit: mm

Order Number	피치규격 Thread			Pitch (TPI)	날수 Flutes Z	산수 Teeth Zt	날경 Diameter D	나사부 길이 Thread Length L1	전장 Overall Length L	샙크 Shank Dia d
	UNC	UNF	UNEF							

#### 외부 급유형 (Without coolant)

4LTMS 021 060 S04	No.4, No.5	No.6		40	4	9	2.1	6	45	4
4LTMS 021 079 S04	No.4, No.5	No.6		40	4	12	2.1	7.9	45	4
4LTMS 0255 075 S04	No.6, No.8	No.10	No.12	32	4	9	2.55	7.5	45	4
4LTMS 0255 099 S04	No.6, No.8	No.10	No.12	32	4	12	2.55	9.9	45	4
4LTMS 033 088 S04		No.8		36	4	12	3.3	8.8	45	4
4LTMS 033 109 S04		No.8		36	4	15	3.3	10.9	45	4
4LTMS 0358 099 S04	No.10, No.12	5/16 ~		24	4	9	3.58	9.9	45	4
4LTMS 0358 131 S04	No.10, No.12	5/16 ~		24	4	12	3.58	13.1	45	4
4LTMS 038 099 S04		No.10	No.12, 5/16 ~	32	4	12	3.8	9.9	45	4
4LTMS 038 130 S04		No.10	No.12, 5/16 ~	32	4	16	3.8	13	45	4
4LTMS 0415 110 S06	No.12	5/16 ~, 3/8 ~		24	4	10	4.15	11	60	6
4LTMS 0415 152 S06	No.12	5/16 ~, 3/8 ~		24	4	14	4.15	15.2	60	6
4LTMS 043 112 S06		No.12, 1/4 ~	7/16 ~	28	4	12	4.3	11.2	60	6
4LTMS 043 149 S06		No.12, 1/4 ~	7/16 ~	28	4	16	4.3	14.9	60	6
4LTMS 044 114 S06			No.12, 1/4 ~, 5/16 ~	32	4	14	4.4	11.4	60	6
4LTMS 044 154 S06			No.12, 1/4 ~, 5/16 ~	32	4	19	4.4	15.4	60	6
4LTMS 0488 132 S06	1/4 ~	7/16 ~, 1/2 ~		20	4	10	4.88	13.2	60	6
4LTMS 0488 170 S06	1/4 ~	7/16 ~, 1/2 ~		20	4	13	4.88	17	60	6
4LTMS 0515 131 S06		1/4 ~	7/16 ~, 1/2 ~	28	4	14	5.15	13.1	60	6
4LTMS 0515 167 S06		1/4 ~	7/16 ~, 1/2 ~	28	4	18	5.15	16.7	60	6
4LTMS 0615 160 S08	5/16 ~	9/16 ~, 5/8 ~		18	4	11	6.15	16	65	8
4LTMS 0615 217 S08	5/16 ~	9/16 ~, 5/8 ~		18	4	15	6.15	21.7	75	8
4LTMS 0668 163 S08		5/16 ~, 3/8 ~	9/16 ~	24	4	15	6.68	16.3	65	8
4LTMS 0668 205 S08		5/16 ~, 3/8 ~	9/16 ~	24	4	19	6.68	20.5	75	8
4LTMS 0765 196 S08	3/8 ~	3/4 ~		16	4	12	7.65	19.6	65	8
4LTMS 0765 244 S08	3/8 ~	3/4 ~		16	4	15	7.65	24.4	75	8
4LTMS 082 195 S10		3/8 ~	9/16 ~, 5/8 ~	24	4	18	8.2	19.5	75	10
4LTMS 082 247 S10		3/8 ~	9/16 ~, 5/8 ~	24	4	23	8.2	24.7	80	10
4LTMS 090 224 S10	7/16 ~	7/8 ~		14	4	12	9	22.4	75	10
4LTMS 090 297 S10	7/16 ~	7/8 ~		14	4	16	9	29.7	80	10
4LTMS 096 221 S10		7/16 ~, 1/2 ~	3/4 ~	20	4	17	9.6	22.1	75	10
4LTMS 096 284 S10		7/16 ~, 1/2 ~	3/4 ~	20	4	22	9.6	28.4	80	10
4LTMS 099 221 S10			7/16 ~, 1/2 ~	28	4	24	9.9	22.1	75	10
4LTMS 099 285 S10			7/16 ~, 1/2 ~	28	4	31	9.9	28.5	80	10
4LTMS 1035 261 S12	1/2 ~			13	4	13	10.35	26.1	80	12
4LTMS 1035 339 S12	1/2 ~			13	4	17	10.35	33.9	90	12
4LTMS 111 259 S12		1/2 ~	3/4 ~, 13/16 ~	20	4	20	11.1	25.9	80	12
4LTMS 111 322 S12		1/2 ~	3/4 ~, 13/16 ~	20	4	25	11.1	32.2	90	12
4LTMS 118 283 S12	9/16 ~	1 ~, 1-1/8 ~		12	4	13	11.8	28.3	80	12
4LTMS 118 367 S12	9/16 ~	1 ~, 1-1/8 ~		12	4	17	11.8	36.7	90	12
4LTMS 125 287 S14		9/16 ~, 5/8 ~	11/16 ~	18	4	20	12.5	28.7	95	14
4LTMS 125 372 S14		9/16 ~, 5/8 ~	11/16 ~	18	4	26	12.5	37.2	100	14
4LTMS 129 290 S14			9/16 ~, 5/8 ~, 11/16 ~	24	4	27	12.9	29	95	14
4LTMS 129 364 S14			9/16 ~, 5/8 ~, 11/16 ~	24	4	34	12.9	36.4	100	14
4LTMS 131 331 S14	5/8 ~			11	4	14	13.1	33.1	95	14
4LTMS 131 424 S14	5/8 ~			11	4	18	13.1	42.4	105	14
4LTMS 141 316 S16		5/8 ~	11/16 ~, 1-1/8 ~	18	4	22	14.1	31.6	95	16
4LTMS 141 414 S16		5/8 ~	11/16 ~, 1-1/8 ~	18	4	29	14.1	41.4	105	16
4LTMS 159 390 S16	3/4 ~			10	4	15	15.9	39	100	16
4LTMS 159 491 S16	3/4 ~			10	4	19	15.9	49.1	110	16
4LTMS 160 387 S16		3/4 ~		16	4	24	16	38.7	105	16
4LTMS 160 482 S16		3/4 ~		16	4	30	16	48.2	115	16
4LTMS 160 386 S16			3/4 ~, 13/16 ~, 7/8 ~	20	4	30	16	38.6	105	16
4LTMS 160 487 S16			3/4 ~, 13/16 ~, 7/8 ~	20	4	38	16	48.7	115	16
4LTMS 160 461 S16	7/8 ~			9	4	16	16	46.1	110	16
4LTMS 160 442 S16		7/8 ~		14	4	24	16	44.2	110	16
4LTMS 160 519 S16	1 ~			8	4	16	16	51.9	120	16
4LTMS 160 515 S16		1 ~, 1-1/8 ~, 1-1/2 ~		12	4	24	16	51.5	120	16



## American UN

단위 Unit: mm

Order Number	피치규격 Thread			Pitch (TPI)	날수 Flutes Z	산수 Teeth Zt	날경 Diameter D	나사부 길이 Thread Length L1	전장 Overall Length L	샙크 Shank Dia d
	UNC	UNF	UNEF							
4LTMS 0358 099 S04C	No.10, No.12	5/16 ~		24	4	9	3.58	9.9	45	4
4LTMS 0358 131 S04C	No.10, No.12	5/16 ~		24	4	12	3.58	13.1	45	4
4LTMS 038 099 S04C		No.10	No.12, 5/16 ~	32	4	12	3.8	9.9	45	4
4LTMS 038 130 S04C		No.10	No.12, 5/16 ~	32	4	16	3.8	13	45	4
4LTMS 0415 110 S06C	No.12	5/16 ~, 3/8 ~		24	4	10	4.15	11	60	6
4LTMS 0415 152 S06C	No.12	5/16 ~, 3/8 ~		24	4	14	4.15	15.2	60	6
4LTMS 043 112 S06C		No.12, 1/4 ~	7/16 ~	28	4	12	4.3	11.2	60	6
4LTMS 043 149 S06C		No.12, 1/4 ~	7/16 ~	28	4	16	4.3	14.9	60	6
4LTMS 044 114 S06C			No.12, 1/4 ~, 5/16 ~	32	4	14	4.4	11.4	60	6
4LTMS 044 154 S06C			No.12, 1/4 ~, 5/16 ~	32	4	19	4.4	15.4	60	6
4LTMS 0488 132 S06C	1/4 ~	7/16 ~, 1/2 ~		20	4	10	4.88	13.2	60	6
4LTMS 0488 170 S06C	1/4 ~	7/16 ~, 1/2 ~		20	4	13	4.88	17	60	6
4LTMS 0515 131 S06C		1/4 ~	7/16 ~, 1/2 ~	28	4	14	5.15	13.1	60	6
4LTMS 0515 167 S06C		1/4 ~	7/16 ~, 1/2 ~	28	4	18	5.15	16.7	60	6
4LTMS 0615 160 S08C	5/16 ~	9/16 ~, 5/8 ~		18	4	11	6.15	16	65	8
4LTMS 0615 217 S08C	5/16 ~	9/16 ~, 5/8 ~		18	4	15	6.15	21.7	75	8
4LTMS 0668 163 S08C		5/16 ~, 3/8 ~	9/16 ~	24	4	15	6.68	16.3	65	8
4LTMS 0668 205 S08C		5/16 ~, 3/8 ~	9/16 ~	24	4	19	6.68	20.5	75	8
4LTMS 0765 196 S08C	3/8 ~	3/4 ~		16	4	12	7.65	19.6	65	8
4LTMS 0765 244 S08C	3/8 ~	3/4 ~		16	4	15	7.65	24.4	75	8
4LTMS 082 195 S10C		3/8 ~	9/16 ~, 5/8 ~	24	4	18	8.2	19.5	75	10
4LTMS 082 247 S10C		3/8 ~	9/16 ~, 5/8 ~	24	4	23	8.2	24.7	80	10
4LTMS 090 224 S10C	7/16 ~	7/8 ~		14	4	12	9	22.4	75	10
4LTMS 090 297 S10C	7/16 ~	7/8 ~		14	4	16	9	29.7	80	10
4LTMS 096 221 S10C		7/16 ~, 1/2 ~	3/4 ~	20	4	17	9.6	22.1	75	10
4LTMS 096 284 S10C		7/16 ~, 1/2 ~	3/4 ~	20	4	22	9.6	28.4	80	10
4LTMS 099 221 S10C			7/16 ~, 1/2 ~	28	4	24	9.9	22.1	75	10
4LTMS 099 285 S10C			7/16 ~, 1/2 ~	28	4	31	9.9	28.5	80	10
4LTMS 1035 261 S12C	1/2 ~			13	4	13	10.35	26.1	80	12
4LTMS 1035 339 S12C	1/2 ~			13	4	17	10.35	33.9	90	12
4LTMS 111 259 S12C		1/2 ~	3/4 ~, 13/16 ~	20	4	20	11.1	25.9	80	12
4LTMS 111 322 S12C		1/2 ~	3/4 ~, 13/16 ~	20	4	25	11.1	32.2	90	12
4LTMS 118 283 S12C	9/16 ~	1 ~, 1-1/8 ~		12	4	13	11.8	28.3	80	12
4LTMS 118 367 S12C	9/16 ~	1 ~, 1-1/8 ~		12	4	17	11.8	36.7	90	12
4LTMS 125 287 S14C		9/16 ~, 5/8 ~	11/16 ~	18	4	20	12.5	28.7	95	14
4LTMS 125 372 S14C		9/16 ~, 5/8 ~	11/16 ~	18	4	26	12.5	37.2	100	14
4LTMS 129 290 S14C			9/16 ~, 5/8 ~, 11/16 ~	24	4	27	12.9	29	95	14
4LTMS 129 364 S14C			9/16 ~, 5/8 ~, 11/16 ~	24	4	34	12.9	36.4	100	14
4LTMS 131 331 S14C	5/8 ~			11	4	14	13.1	33.1	95	14
4LTMS 131 424 S14C	5/8 ~			11	4	18	13.1	42.4	105	14
4LTMS 141 316 S16C		5/8 ~	11/16 ~, 1-1/8 ~	18	4	22	14.1	31.6	95	16
4LTMS 141 414 S16C		5/8 ~	11/16 ~, 1-1/8 ~	18	4	29	14.1	41.4	105	16
4LTMS 159 390 S16C	3/4 ~			10	4	15	15.9	39	100	16
4LTMS 159 491 S16C	3/4 ~			10	4	19	15.9	49.1	110	16
4LTMS 160 387 S16C		3/4 ~		16	4	24	16	38.7	105	16
4LTMS 160 482 S16C		3/4 ~		16	4	30	16	48.2	115	16
4LTMS 160 386 S16C			3/4 ~, 13/16 ~, 7/8 ~	20	4	30	16	38.6	105	16
4LTMS 160 487 S16C			3/4 ~, 13/16 ~, 7/8 ~	20	4	38	16	48.7	115	16
4LTMS 160 461 S16C	7/8 ~			9	4	16	16	46.1	110	16
4LTMS 160 442 S16C		7/8 ~		14	4	24	16	44.2	110	16
4LTMS 160 519 S16C	1 ~			8	4	16	16	51.9	120	16
4LTMS 160 515 S16C		1 ~, 1-1/8 ~, 1-1/2 ~		12	4	24	16	51.5	120	16

## 내부 급유형 (With coolant)

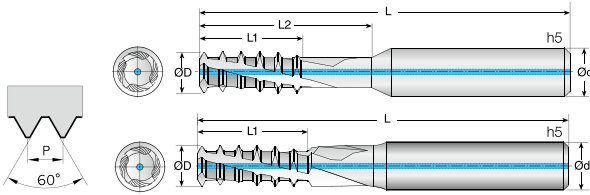
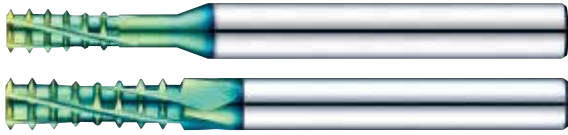

- HRc 62이하의 열처리강, 프리하든강, 합금강, 탄소강, 주철 가공
- 높은 절삭 속도와 날 당 높은 이송이 가능합니다.
- 최대 나사가공 깊이 : 2xD, 2.5xD, 3xD(나사가공 직경)
- 더 깊은 나사가공을 위한 헬리컬 리브 타입을 채용하였습니다.
- 헬리코일 나사 가공이 가능합니다.
- 오른나사 및 왼나사 작업이 모두 가능합니다.

#### Thread mills for Hardened steels (up to HRc 62), pre-hardened steels, alloy steels, carbon steels, cast irons

- High spindle speed and feed per tooth are available.
- Maximum drilling depth : 2xD, 2.5xD, 3xD (threading diameter)
- Rib type helical design is applied for deep threading.
- It can be used for heli coil threading.
- Both right and left threading are available.

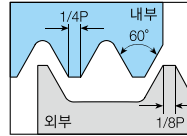

521P

ISO 측정항목

단위 Unit: mm

Order Number	피치 규격		날수 Flutes Z	날경 Diameter D	나사부길이 Thread Length L1	유효장 Effective Length L2	전장 Overall Length L	샙크 Shank Dia d
	Thread	Pitch						

#### 외부 급유형 (Without coolant)

4NKTM 022 060 S06 M3	M3	0.5	4	2.2	6	-	60	6
4NKTM 022 080 S06 M3	M3	0.5	4	2.2	8	-	60	6
4NKTM 024 090 S04 M3	M3	0.5	4	2.4	5.47	9	45	4
4NKTM 029 084 S06 M4	M4	0.7	4	2.9	8.4	-	60	6
4NKTM 029 112 S06 M4	M4	0.7	4	2.9	11.2	-	60	6
4NKTM 0315 120 S04 M4	M4	0.7	4	3.15	7.64	12	45	4
4NKTM 038 112 S06 M5	M5	0.8	4	3.8	11.2	-	60	6
4NKTM 038 128 S06 M5	M5	0.8	4	3.8	12.8	-	60	6
4NKTM 039 150 S04 M5	M5	0.8	4	3.9	8.73	15	50	4
4NKTM 045 120 S06 M6	M6	1	4	4.5	12	-	60	6
4NKTM 045 160 S06 M6	M6	1	4	4.5	16	-	60	6
4NKTM 048 180 S06 M6	M6	1	4	4.8	10.9	18	60	6
4NKTM 060 175 S06 M8	M8	1.25	4	6	17.5	-	65	6
4NKTM 060 200 S06 M8	M8	1.25	4	6	20	-	65	6
4NKTM 065 240 S08 M8	M8	1.25	4	6.5	13.62	24	65	8
4NKTM 075 210 S08 M10	M10	1.5	4	7.5	21	-	75	8
4NKTM 075 270 S08 M10	M10	1.5	4	7.5	27	-	75	8
4NKTM 082 300 S10 M10	M10	1.5	4	8.2	16.34	30	75	10
4NKTM 095 245 S10 M12	M12	1.75	4	9.5	24.5	-	80	10
4NKTM 095 315 S10 M12	M12	1.75	4	9.5	31.5	-	80	10
4NKTM 099 360 S10 M12	M12	1.75	4	9.9	19.06	36	85	10
4NKTM 100 280 S10 M14	M14	2	4	10	28	-	85	10
4NKTM 100 360 S10 M14	M14	2	4	10	36	-	90	10
4NKTM 116 420 S12 M14	M14	2	4	11.6	21.75	42	90	12
4NKTM 120 320 S12 M16	M16	2	4	12	32	-	95	12
4NKTM 120 400 S12 M16	M16	2	4	12	40	-	100	12
4NKTM 136 480 S14 M16	M16	2	4	13.6	25.75	48	100	14
4NKTM 140 400 S14 M18	M18	2.5	4	14	40	-	95	14
4NKTM 140 450 S14 M18	M18	2.5	4	14	45	-	105	14
4NKTM 160 400 S16 M20	M20	2.5	4	16	40	-	105	16
4NKTM 160 500 S16 M20	M20	2.5	4	16	50	-	115	16





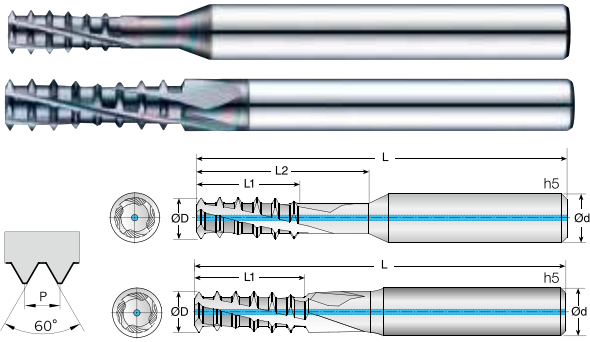

- 알루미늄, 알루미늄 합금 등 비철 비금속 가공
- 높은 절삭 속도와 날 당 높은 이송이 가능합니다.
- 최대 나사가공 깊이 : 2xD, 2.5xD, 3xD(나사가공 직경)
- 더 깊은 나사가공을 위한 헬리컬 리브 타입을 채용하였습니다.
- 헬리코일 나사 가공이 가능합니다.
- 오른나사 및 왼나사 작업이 모두 가능합니다.

#### Thread mills for Aluminum, Aluminum alloys, non-ferrous, and non-metallic materials

- High spindle speed and feed per tooth are available.
- Maximum drilling depth : 2xD, 2.5xD, 3xD (threading diameter)
- Rib type helical design is applied for deep threading.
- It can be used for heli coil threading.
- Both right and left threading are available.

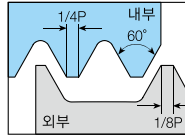

521P

#### ISO 측정항목

단위 Unit: mm

Order Number	피치 규격		날수 Flutes Z	날경 Diameter D	나사부길이 Thread Length L1	유효장 Effective Length L2	전장 Overall Length L	샹크 Shank Dia d
	Thread	Pitch						

#### 외부 급유형 (Without coolant)

4NKTMA 022 060 S06 M3	M3	0.5	4	2.2	6	-	60	6
4NKTMA 022 080 S06 M3	M3	0.5	4	2.2	8	-	60	6
4NKTMA 024 090 S04 M3	M3	0.5	4	2.4	5.47	9	45	4
4NKTMA 029 084 S06 M4	M4	0.7	4	2.9	8.4	-	60	6
4NKTMA 029 112 S06 M4	M4	0.7	4	2.9	11.2	-	60	6
4NKTMA 0315 120 S04 M4	M4	0.7	4	3.15	7.64	12	45	4
4NKTMA 038 112 S06 M5	M5	0.8	4	3.8	11.2	-	60	6
4NKTMA 038 128 S06 M5	M5	0.8	4	3.8	12.8	-	60	6
4NKTMA 039 150 S04 M5	M5	0.8	4	3.9	8.73	15	50	4
4NKTMA 045 120 S06 M6	M6	1	4	4.5	12	-	60	6
4NKTMA 045 160 S06 M6	M6	1	4	4.5	16	-	60	6
4NKTMA 048 180 S06 M6	M6	1	4	4.8	10.9	18	60	6
4NKTMA 060 175 S06 M8	M8	1.25	4	6	17.5	-	65	6
4NKTMA 060 200 S06 M8	M8	1.25	4	6	20	-	65	6
4NKTMA 065 240 S08 M8	M8	1.25	4	6.5	13.62	24	65	8
4NKTMA 075 210 S08 M10	M10	1.5	4	7.5	21	-	75	8
4NKTMA 075 270 S08 M10	M10	1.5	4	7.5	27	-	75	8
4NKTMA 082 300 S10 M10	M10	1.5	4	8.2	16.34	30	75	10
4NKTMA 095 245 S10 M12	M12	1.75	4	9.5	24.5	-	80	10
4NKTMA 095 315 S10 M12	M12	1.75	4	9.5	31.5	-	80	10
4NKTMA 099 360 S10 M12	M12	1.75	4	9.9	19.06	36	85	10
4NKTMA 100 280 S10 M14	M14	2	4	10	28	-	85	10
4NKTMA 100 360 S10 M14	M14	2	4	10	36	-	90	10
4NKTMA 116 420 S12 M14	M14	2	4	11.6	21.75	42	90	12
4NKTMA 120 320 S12 M16	M16	2	4	12	32	-	95	12
4NKTMA 120 400 S12 M16	M16	2	4	12	40	-	100	12
4NKTMA 136 480 S14 M16	M16	2	4	13.6	25.75	48	100	14
4NKTMA 140 400 S14 M18	M18	2.5	4	14	40	-	95	14
4NKTMA 140 450 S14 M18	M18	2.5	4	14	45	-	105	14
4NKTMA 160 400 S16 M20	M20	2.5	4	16	40	-	105	16
4NKTMA 160 500 S16 M20	M20	2.5	4	16	50	-	115	16



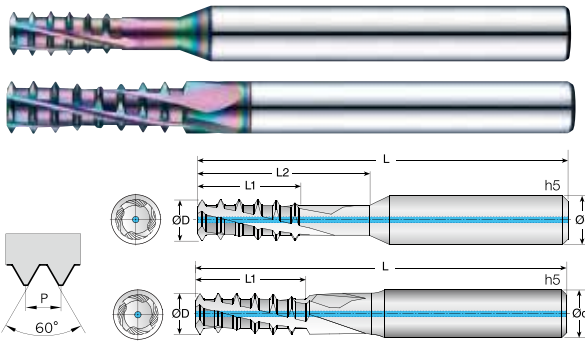

- SUS, 티타늄 합금 가공
- 높은 절삭 속도와 날 당 높은 이송이 가능합니다.
- 최대 나사가공 깊이 : 2xD, 2.5xD, 3xD(나사가공 직경)
- 더 깊은 나사가공을 위한 헬리컬 리브 타입을 채용하였습니다.
- 헬리코일 나사 가공이 가능합니다.
- 오른나사 및 왼나사 작업이 모두 가능합니다.

#### Thread Mills for SUS, Titanium alloys

- High spindle speed and feed per tooth are available.
- Maximum drilling depth : 2xD, 2.5xD, 3xD (threading diameter)
- Rib type helical design is applied for deep threading.
- It can be used for heli coil threading.
- Both right and left threading are available.

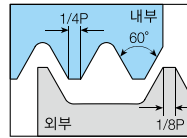

521P

ISO 측정항목

단위 Unit: mm

Order Number	피치 규격		날수 Flutes Z	날경 Diameter D	나사부 길이 Thread Length L1	유효장 Effective Length L2	전장 Overall Length L	샹크 Shank Dia d
	Thread	Pitch						

#### 외부 급유형 (Without coolant)

4NKTMS 022 060 S06 M3	M3	0.5	4	2.2	6	-	60	6
4NKTMS 022 080 S06 M3	M3	0.5	4	2.2	8	-	60	6
4NKTMS 024 090 S04 M3	M3	0.5	4	2.4	5.47	9	45	4
4NKTMS 029 084 S06 M4	M4	0.7	4	2.9	8.4	-	60	6
4NKTMS 029 112 S06 M4	M4	0.7	4	2.9	11.2	-	60	6
4NKTMS 0315 120 S04 M4	M4	0.7	4	3.15	7.64	12	45	4
4NKTMS 038 112 S06 M5	M5	0.8	4	3.8	11.2	-	60	6
4NKTMS 038 128 S06 M5	M5	0.8	4	3.8	12.8	-	60	6
4NKTMS 039 150 S04 M5	M5	0.8	4	3.9	8.73	15	50	4
4NKTMS 045 120 S06 M6	M6	1	4	4.5	12	-	60	6
4NKTMS 045 160 S06 M6	M6	1	4	4.5	16	-	60	6
4NKTMS 048 180 S06 M6	M6	1	4	4.8	10.9	18	60	6
4NKTMS 060 175 S06 M8	M8	1.25	4	6	17.5	-	65	6
4NKTMS 060 200 S06 M8	M8	1.25	4	6	20	-	65	6
4NKTMS 065 240 S08 M8	M8	1.25	4	6.5	13.62	24	65	8
4NKTMS 075 210 S08 M10	M10	1.5	4	7.5	21	-	75	8
4NKTMS 075 270 S08 M10	M10	1.5	4	7.5	27	-	75	8
4NKTMS 082 300 S10 M10	M10	1.5	4	8.2	16.34	30	75	10
4NKTMS 095 245 S10 M12	M12	1.75	4	9.5	24.5	-	80	10
4NKTMS 095 315 S10 M12	M12	1.75	4	9.5	31.5	-	80	10
4NKTMS 099 360 S10 M12	M12	1.75	4	9.9	19.06	36	85	10
4NKTMS 100 280 S10 M14	M14	2	4	10	28	-	85	10
4NKTMS 100 360 S10 M14	M14	2	4	10	36	-	90	10
4NKTMS 116 420 S12 M14	M14	2	4	11.6	21.75	42	90	12
4NKTMS 120 320 S12 M16	M16	2	4	12	32	-	95	12
4NKTMS 120 400 S12 M16	M16	2	4	12	40	-	100	12
4NKTMS 136 480 S14 M16	M16	2	4	13.6	25.75	48	100	14
4NKTMS 140 400 S14 M18	M18	2.5	4	14	40	-	95	14
4NKTMS 140 450 S14 M18	M18	2.5	4	14	45	-	105	14
4NKTMS 160 400 S16 M20	M20	2.5	4	16	40	-	105	16
4NKTMS 160 500 S16 M20	M20	2.5	4	16	50	-	115	16



# 4BSPT

4 Flutes Pipe Taper Short Thread Mills for Multi Purpose

## 4날 범용 관용 테이퍼 나사 가공 짧은 날 쓰레드밀

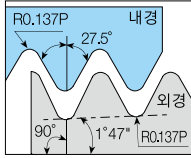
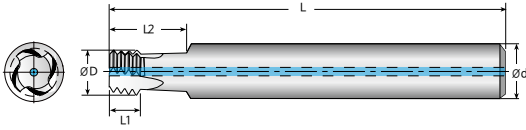

규격 정의 : B.S.21:1985  
공차 등급 : 표준 BSPT(PT)



522P

American UN

단위 Unit: mm

Order Number	나사 가능 규격 Thread	피치 규격 Pitch (TPI)	날수 Flutes Z	산수 Teeth Zt	날경 Diameter D	나사부 길이 Thread Length L1	유효장 Effective Length L2	전장 Overall Length L	샙크 Shank Dia d
--------------	--------------------	----------------------	-------------------	-------------------	---------------------	-------------------------------	-------------------------------	---------------------------	----------------------

### 외부 급유형 (Without coolant)

4BSPT 055 200 S06	1/16", 1/8"	28	4	4	5.5	3.6	20	60	6
4BSPT 0931 335 S10	1/4", 3/8"	19	4	4	9.31	5.2	33.5	70	10
4BSPT 1334 440 S16	1/2", 3/4"	14	4	4	13.34	7.1	44	90	16
4BSPT 1484 420 S16	1", 1 1/4", 1 1/2", 2"	11	4	4	14.84	9.1	42	105	16

### 내부 급유형 (With coolant)

4BSPT 055 200 S06C	1/16", 1/8"	28	4	4	5.5	3.6	20	60	6
4BSPT 0931 335 S10C	1/4", 3/8"	19	4	4	9.31	5.2	33.5	70	10
4BSPT 1334 440 S16C	1/2", 3/4"	14	4	4	13.34	7.1	44	90	16
4BSPT 1484 420 S16C	1", 1 1/4", 1 1/2", 2"	11	4	4	14.84	9.1	42	105	16

나사공구이의수   
경사각도

나사공구이의수   
경사각도

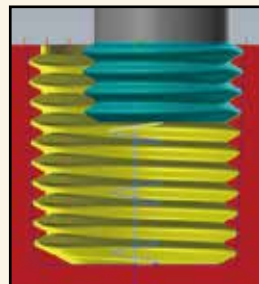
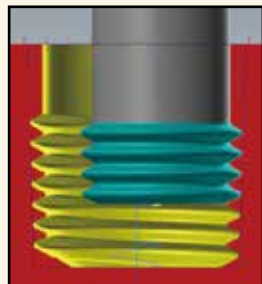

- 나사산 가공시에 4산 기준으로 프로그램 설정하면 게이지 측정이 불가하므로, 3산으로 설정하여 사용하십시오.
- When threading, it is not possible to measure the gauge when setting the program based on 4 threads, so set it to 3 threads and use it.

# 4BSPTA

## 4 Flutes Pipe Taper Short Thread Mills for Aluminum

### 4날 알루미늄 관용 테이퍼 나사 가공 짧은 날 쓰레드밀

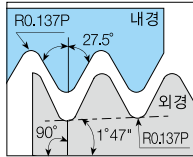
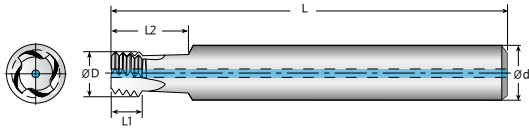

규격 정의 : B.S.21:1985  
공차 등급 : 표준 BSPT(PT)

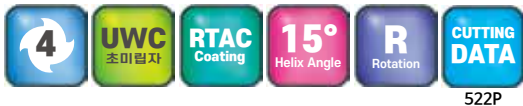

American UN

단위 Unit: mm

Order Number	나사 가능 규격 Thread	피치 규격 Pitch (TPI)	날수 Flutes Z	산수 Teeth Zt	날경 Diameter D	나사부 길이 Thread Length L1	유효장 Effective Length L2	전장 Overall Length L	샙크 Shank Dia d
<b>외부 급유형 (Without coolant)</b>									
4BSPTA 055 200 S06	1/16", 1/8"	28	4	4	5.5	3.6	20	60	6
4BSPTA 0931 335 S10	1/4", 3/8"	19	4	4	9.31	5.2	33.5	70	10
4BSPTA 1334 440 S16	1/2", 3/4"	14	4	4	13.34	7.1	44	90	16
4BSPTA 1484 420 S16	1", 1 1/4", 1 1/2", 2"	11	4	4	14.84	9.1	42	105	16

<b>내부 급유형 (With coolant)</b>									
4BSPTA 055 200 S06C	1/16", 1/8"	28	4	4	5.5	3.6	20	60	6
4BSPTA 0931 335 S10C	1/4", 3/8"	19	4	4	9.31	5.2	33.5	70	10
4BSPTA 1334 440 S16C	1/2", 3/4"	14	4	4	13.34	7.1	44	90	16
4BSPTA 1484 420 S16C	1", 1 1/4", 1 1/2", 2"	11	4	4	14.84	9.1	42	105	16

나사공구이의수   
경사각도

나사공구이의수   
경사각도

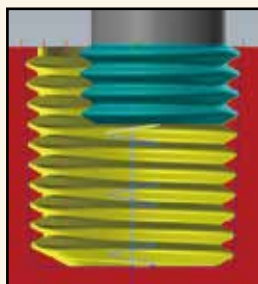
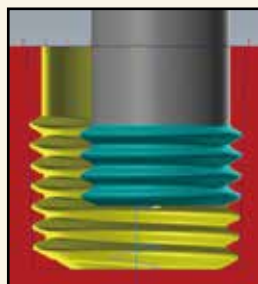

- 나사산 가공시에 4산 기준으로 프로그램 설정하면 게이저 측정이 불가하므로, 3산으로 설정하여 사용하십시오.
- When threading, it is not possible to measure the gauge when setting the program based on 4 threads, so set it to 3 threads and use it.

# 4BSPTS

4 Flutes Pipe Taper Short Thread Mills for Stainless Steel

## 4날 SUS 관용 테이퍼 나사 가공 짧은 날 쓰레드밀

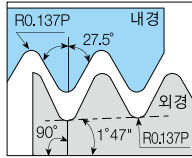
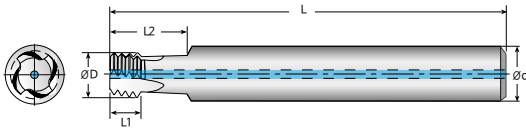

규격 정의 B.S.21:1985  
공차 등급 : 표준 BSPT(PT)

- SUS, 티타늄 합금 가공
- 내부 홀을 통한 효과적인 냉각수 공급이 가능합니다.
- 절삭 영역으로 직접 절삭유를 공급합니다.
- 외부 냉각을 사용할 수 없거나 효과가 없을 때 탁월합니다.
- 낮은 절삭부하를 위해 테이퍼 엔드밀 사용을 권장합니다.
- 오른나사 및 왼나사 작업이 모두 가능합니다.

### Thread mills for SUS and Titanium alloys

- Effective cooling water supply is possible with coolant.
- Direct oil supplying is possible to cutting area.
- More effective when you cannot use outer coolant.
- Recommend to us Taper Endmill for low machining load.
- Both right and left threading are available.

4

UWC  
초미립자

HR  
Coating

15°  
Helix Angle

R  
Rotation

CUTTING  
DATA

520P

American UN

단위 Unit: mm

Order Number	나사 가능 규격 Thread	피치 규격 Pitch (TPI)	날수 Flutes Z	산수 Teeth Zt	날경 Diameter D	나사부 길이 Thread Length L1	유효장 Effective Length L2	전장 Overall Length L	샤홅크 Shank Dia d
<b>외부 급유형 (Without coolant)</b>									
4BSPTS 055 200 S06	1/16", 1/8"	28	4	4	5.5	3.6	20	60	6
4BSPTS 0931 335 S10	1/4", 3/8"	19	4	4	9.31	5.2	33.5	70	10
4BSPTS 1334 440 S16	1/2", 3/4"	14	4	4	13.34	7.1	44	90	16
4BSPTS 1484 420 S16	1", 1 1/4", 1 1/2", 2"	11	4	4	14.84	9.1	42	105	16

<b>내부 급유형 (With coolant)</b>									
4BSPTS 055 200 S06C	1/16", 1/8"	28	4	4	5.5	3.6	20	60	6
4BSPTS 0931 335 S10C	1/4", 3/8"	19	4	4	9.31	5.2	33.5	70	10
4BSPTS 1334 440 S16C	1/2", 3/4"	14	4	4	13.34	7.1	44	90	16
4BSPTS 1484 420 S16C	1", 1 1/4", 1 1/2", 2"	11	4	4	14.84	9.1	42	105	16

나사공구이의수   
경사각도

나사공구이의수   
경사각도

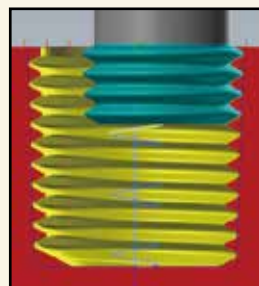
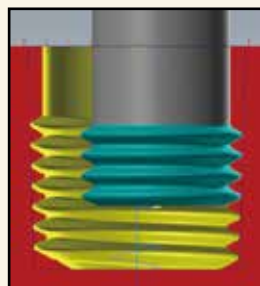

- 나사산 가공시에 4산 기준으로 프로그램 설정하면 게이지 측정이 불가하므로, 3산으로 설정하여 사용하십시오.
- When threading, it is not possible to measure the gauge when setting the program based on 4 threads, so set it to 3 threads and use it.



# 4NPTS

4 Flutes Pipe Taper Short Thread Mills for Multi Purpose

## 4날 범용 관용 테이퍼 나사 가공 짧은 날 쓰레드밀

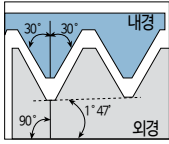
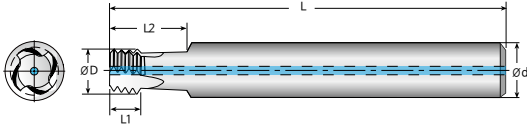

• 규격 정의 : B.S.2779:1956  
• 공차 등급 : Medium class



522P

American UN

단위 Unit: mm

Order Number	나사 가능 규격 Thread	피치 규격 Pitch (TPI)	날수 Flutes Z	산수 Teeth Zt	날경 Diameter D	나사부 길이 Thread Length L1	유효장 Effective Length L2	전장 Overall Length L	샙크 Shank Dia d
<b>외부 급유형 (Without coolant)</b>									
4NPTS 0555 105 S06	1/16", 1/8"	27	4	4	5.55	3.8	10.5	60	6
4NPTS 0937 155 S10	1/4", 3/8"	18	4	4	9.37	5.6	15.5	70	10
4NPTS 1357 260 S16	1/2", 5/8", 3/4"	14	4	4	13.57	7.3	26	90	16
4NPTS 1489 335 S16	1", 1 1/4", 1 1/2", 2"	11.5	4	4	14.89	8.9	33.5	105	16

<b>내부 급유형 (With coolant)</b>									
4NPTS 0555 105 S06C	1/16", 1/8"	27	4	4	5.55	3.8	10.5	60	6
4NPTS 0937 155 S10C	1/4", 3/8"	18	4	4	9.37	5.6	15.5	70	10
4NPTS 1357 260 S16C	1/2", 5/8", 3/4", 7/8"	14	4	4	13.57	7.3	26	90	16
4NPTS 1489 335 S16C	1", 1 1/4", 1 1/2", 2"	11.5	4	4	14.89	8.9	33.5	105	16

나사공구이의수   
경사각도

나사공구이의수   
경사각도

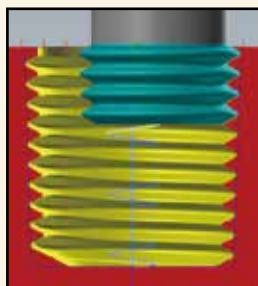
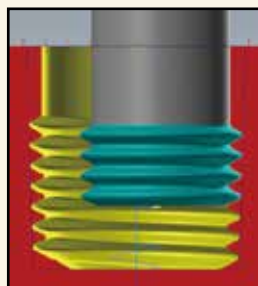

- 나사산 가공시에 4산 기준으로 프로그램 설정하면 게이지 측정이 불가하므로, 3산으로 설정하여 사용하십시오.
- When threading, it is not possible to measure the gauge when setting the program based on 4 threads, so set it to 3 threads and use it.

THREAD MILL

# 4NPTSA

## 4 Flutes Pipe Taper Short Thread Mills for Aluminum

### 4날 알루미늄 관용 테이퍼 나사 가공 짧은 날 쓰레드밀

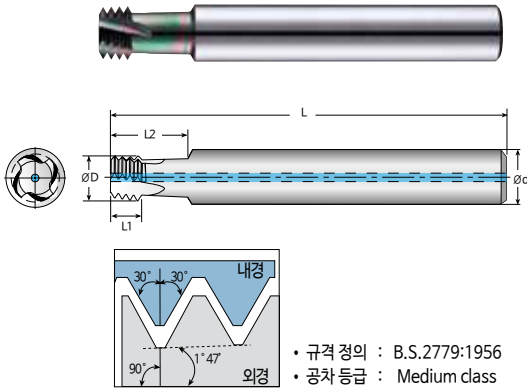

• 규격 정의 : B.S.2779:1956  
• 공차 등급 : Medium class

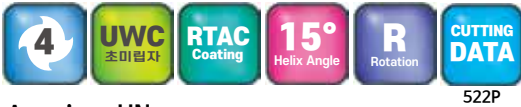

522P

American UN

단위 Unit: mm

Order Number	나사 가능 규격 Thread	피치 규격 Pitch (TPI)	날수 Flutes Z	산수 Teeth Zt	날경 Diameter D	나사부 길이 Thread Length L1	유효장 Effective Length L2	전장 Overall Length L	샙크 Shank Dia d
<b>외부 급유형 (Without coolant)</b>									
4NPTSA 0555 105 S06	1/16", 1/8"	27	4	4	5.55	3.8	10.5	60	6
4NPTSA 0937 155 S10	1/4", 3/8"	18	4	4	9.37	5.6	15.5	70	10
4NPTSA 1357 260 S16	1/2", 5/8", 3/4"	14	4	4	13.57	7.3	26	90	16
4NPTSA 1489 335 S16	1", 1 1/4", 1 1/2", 2"	11.5	4	4	14.89	8.9	33.5	105	16

<b>내부 급유형 (With coolant)</b>									
4NPTSA 0555 105 S06C	1/16", 1/8"	27	4	4	5.55	3.8	10.5	60	6
4NPTSA 0937 155 S10C	1/4", 3/8"	18	4	4	9.37	5.6	15.5	70	10
4NPTSA 1357 260 S16C	1/2", 5/8", 3/4", 7/8"	14	4	4	13.57	7.3	26	90	16
4NPTSA 1489 335 S16C	1", 1 1/4", 1 1/2", 2"	11.5	4	4	14.89	8.9	33.5	105	16

나사공구이의수

경사각도

나사산수: 4나사산 프로그램 설정시 게이지 작업 불가

나사공구이의수

경사각도

- 나사산 가공시에 4산 기준으로 프로그램 설정하면 게이지 측정이 불가하므로, 3산으로 설정하여 사용하십시오.
- When threading, it is not possible to measure the gauge when setting the program based on 4 threads, so set it to 3 threads and use it.

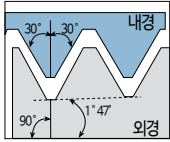
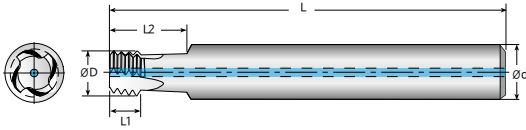

• 규격 정의 : B.S.2779:1956  
• 공차 등급 : Medium class

4

UWC  
초미립자

HR  
Coating

15°  
Helix Angle

R  
Rotation

CUTTING  
DATA

522P

American UN

단위 Unit: mm

Order Number	나사 가능 규격 Thread	피치 규격 Pitch (TPI)	날수 Flutes Z	산수 Teeth Zt	날경 Diameter D	나사부 길이 Thread Length L1	유효장 Effective Length L2	전장 Overall Length L	샙크 Shank Dia d
<b>외부 급유형 (Without coolant)</b>									
4NPTSS 0555 105 S06	1/16", 1/8"	27	4	4	5.55	3.8	10.5	60	6
4NPTSS 0937 155 S10	1/4", 3/8"	18	4	4	9.37	5.6	15.5	70	10
4NPTSS 1357 260 S16	1/2", 5/8", 3/4"	14	4	4	13.57	7.3	26	90	16
4NPTSS 1489 335 S16	1", 1 1/4", 1 1/2", 2"	11.5	4	4	14.89	8.9	33.5	105	16

<b>내부 급유형 (With coolant)</b>									
4NPTSS 0555 105 S06C	1/16", 1/8"	27	4	4	5.55	3.8	10.5	60	6
4NPTSS 0937 155 S10C	1/4", 3/8"	18	4	4	9.37	5.6	15.5	70	10
4NPTSS 1357 260 S16C	1/2", 5/8", 3/4", 7/8"	14	4	4	13.57	7.3	26	90	16
4NPTSS 1489 335 S16C	1", 1 1/4", 1 1/2", 2"	11.5	4	4	14.89	8.9	33.5	105	16

나사공구이의수

경사각도

나사공구이의수

경사각도

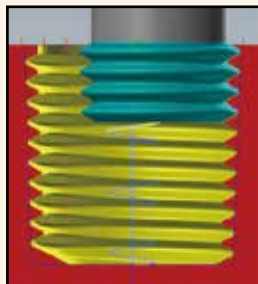
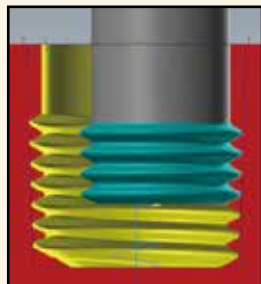

- 나사산 가공시에 4산 기준으로 프로그램 설정하면 게이지 측정이 불가하므로, 3산으로 설정하여 사용하십시오.
- When threading, it is not possible to measure the gauge when setting the program based on 4 threads, so set it to 3 threads and use it.

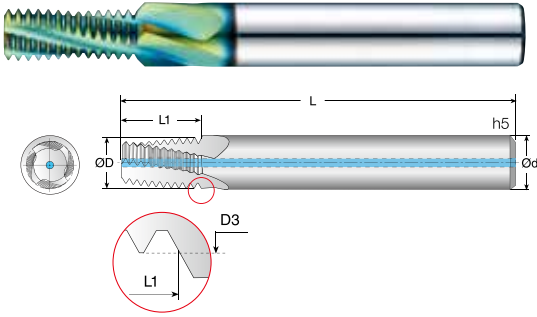

- HRc 48 이하의 고경도강, 프리하든강, 합금강, 탄소강, 주철 가공
- 내부 홀을 통한 효과적인 냉각수 공급이 가능합니다.
- 절삭 영역으로 직접 절삭유를 공급하여 칩의 응착 현상을 제거합니다.
- 낮은 절삭부하를 위해 테이퍼 엔드밀 사용을 권장 합니다.
- 오른나사 및 왼나사 작업이 모두 가능합니다.

- Thread mills for Hardened steels (up to HRc 48), pre-hardened steels, alloy steels, carbon steels, cast irons
- Effective cooling water supply is possible with coolant.
- With coolant, it removes chip sticking.
- Using taper endmill is recommended to reduce cutting wear.
- Both right and left threading are available.

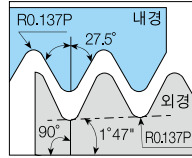

규격 정의 : B.S.21:1985  
공차 등급 : 표준 BSPT

4

UWC  
초미립자

TISIN-S  
Coating

15°  
Helix Angle

R  
Rotation

CUTTING  
DATA

522P

American UN

단위 Unit: mm

Order Number	피치 규격 Thread	Pitch (TPI)	날수 Flutes Z	산수 Teeth Zt	날경 Diameter D	나사부 길이 Thread Length L1	전장 Overall Length L	샤희크 Shank Dia d
<b>외부 급유형 (Without coolant)</b>								
4BSTM 059 103 S06	1/16 ~, 1/8 ~	28	4	11	5.9	10.3	60	6
4BSTM 0765 103 S08	1/8 ~	28	4	11	7.65	10.3	60	8
4BSTM 099 152 S10	1/4 ~, 3/8 ~	19	4	11	9.9	15.2	70	10
4BSTM 1115 152 S12	3/8 ~	19	4	11	11.15	15.2	70	12
4BSTM 1425 224 S16	1/2 ~, 3/4 ~	14	4	12	14.25	22.4	90	16
4BSTM 160 285 S16	1", 1 1/4", 1 1/2", 2"	11	4	12	16	28.5	105	16

<b>내부 급유형 (With coolant)</b>								
4BSTM 059 103 S06C	1/16 ~, 1/8 ~	28	4	11	5.9	10.3	60	6
4BSTM 0765 103 S08C	1/8 ~	28	4	11	7.65	10.3	60	8
4BSTM 099 152 S10C	1/4 ~, 3/8 ~	19	4	11	9.9	15.2	70	10
4BSTM 1115 152 S12C	3/8 ~	19	4	11	11.15	15.2	70	12
4BSTM 1425 224 S16C	1/2 ~, 3/4 ~	14	4	12	14.25	22.4	90	16
4BSTM 160 285 S16C	1", 1 1/4", 1 1/2", 2"	11	4	12	16	28.5	105	16

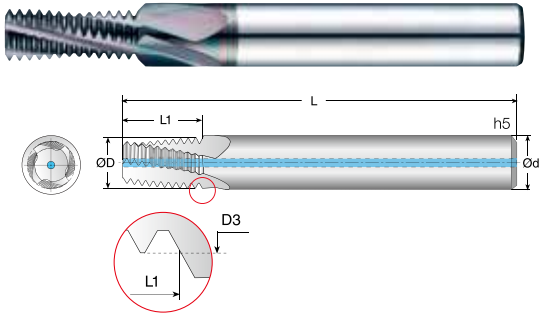

- 알루미늄, 알루미늄 합금 등 비철 비금속 가공
- 내부 홀을 통한 효과적인 냉각수 공급이 가능합니다.
- 절삭 영역으로 직접 절삭유를 공급하여 칩의 응착 현상을 제거합니다.
- 낮은 절삭부하를 위해 테이퍼 엔드밀 사용을 권장 합니다.
- 오른나사 및 왼나사 작업이 모두 가능합니다.

#### Thread mills for Aluminum, Aluminum alloys, non-ferrous, and non-metallic materials.

- Effective cooling water supply is possible with coolant.
- With coolant, it removes chip sticking.
- Using taper endmill is recommended to reduce cutting wear.
- Both right and left threading are available.

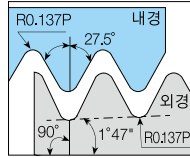

규격 정의 : B.S.21:1985  
공차 등급 : 표준 BSPT

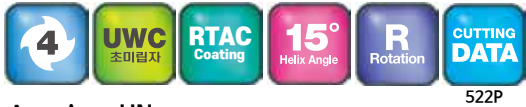

American UN

단위 Unit: mm

Order Number	피치 규격 Thread	Pitch (TPI)	날수 Flutes Z	산수 Teeth Zt	날경 Diameter D	나사부 길이 Thread Length L1	전장 Overall Length L	샤프크 Shank Dia d
<b>외부 급유형 (Without coolant)</b>								
4BSTMA 059 103 S06	1/16 ~, 1/8 ~	28	4	11	5.9	10.3	60	6
4BSTMA 0765 103 S08	1/8 ~	28	4	11	7.65	10.3	60	8
4BSTMA 099 152 S10	1/4 ~, 3/8 ~	19	4	11	9.9	15.2	70	10
4BSTMA 1115 152 S12	3/8 ~	19	4	11	11.15	15.2	70	12
4BSTMA 1425 224 S16	1/2 ~, 3/4 ~	14	4	12	14.25	22.4	90	16
4BSTMA 160 285 S16	1", 1 1/4", 1 1/2", 2"	11	4	12	16	28.5	105	16

<b>내부 급유형 (With coolant)</b>								
Order Number	피치 규격 Thread	Pitch (TPI)	날수 Flutes Z	산수 Teeth Zt	날경 Diameter D	나사부 길이 Thread Length L1	전장 Overall Length L	샤프크 Shank Dia d
4BSTMA 059 103 S06C	1/16 ~, 1/8 ~	28	4	11	5.9	10.3	60	6
4BSTMA 0765 103 S08C	1/8 ~	28	4	11	7.65	10.3	60	8
4BSTMA 099 152 S10C	1/4 ~, 3/8 ~	19	4	11	9.9	15.2	70	10
4BSTMA 1115 152 S12C	3/8 ~	19	4	11	11.15	15.2	70	12
4BSTMA 1425 224 S16C	1/2 ~, 3/4 ~	14	4	12	14.25	22.4	90	16
4BSTMA 160 285 S16C	1", 1 1/4", 1 1/2", 2"	11	4	12	16	28.5	105	16

# 4BSTMS 4 Flutes Pipe Taper Thread Mills for Stainless Steel

## 4날 SUS 관용 테이퍼 나사 가공 쓰레드밀

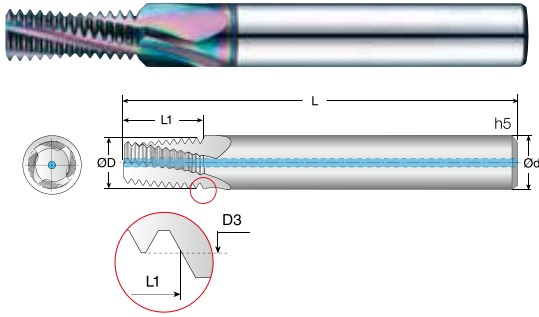

- SUS, 티타늄 합금 가공
  - 내부 홀을 통한 효과적인 냉각수 공급이 가능합니다.
  - 절삭 영역으로 직접 절삭유를 공급하여 칩의 응착 현상을 제거합니다.
  - 낮은 절삭부하를 위해 테이퍼 엔드밀 사용을 권장 합니다.
  - 오른나사 및 왼나사 작업이 모두 가능합니다.
- Thread Mills for SUS, Titanium alloys
  - Effective cooling water supply is possible with coolant.
  - With coolant, it removes chip sticking.
  - Using taper endmill is recommended to reduce cutting wear.
  - Both right and left threading are available.

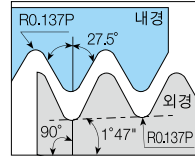

규격 정의 : B.S.21:1985  
공차 등급 : 표준 BSPT

American UN

단위 Unit: mm

Order Number	피치 규격 Thread	Pitch (TPI)	날수 Flutes Z	산수 Teeth Zt	날경 Diameter D	나사부 길이 Thread Length L1	전장 Overall Length L	샙크 Shank Dia d
<b>외부 급유형 (Without coolant)</b>								
4BSTMS 059 103 S06	1/16 ~, 1/8 ~	28	4	11	5.9	10.3	60	6
4BSTMS 0765 103 S08	1/8 ~	28	4	11	7.65	10.3	60	8
4BSTMS 099 152 S10	1/4 ~, 3/8 ~	19	4	11	9.9	15.2	70	10
4BSTMS 1115 152 S12	3/8 ~	19	4	11	11.15	15.2	70	12
4BSTMS 1425 224 S16	1/2 ~, 3/4 ~	14	4	12	14.25	22.4	90	16
4BSTMS 160 285 S16	1", 1 1/4", 1 1/2", 2"	11	4	12	16	28.5	105	16

<b>내부 급유형 (With coolant)</b>								
Order Number	피치 규격 Thread	Pitch (TPI)	날수 Flutes Z	산수 Teeth Zt	날경 Diameter D	나사부 길이 Thread Length L1	전장 Overall Length L	샙크 Shank Dia d
4BSTMS 059 103 S06C	1/16 ~, 1/8 ~	28	4	11	5.9	10.3	60	6
4BSTMS 0765 103 S08C	1/8 ~	28	4	11	7.65	10.3	60	8
4BSTMS 099 152 S10C	1/4 ~, 3/8 ~	19	4	11	9.9	15.2	70	10
4BSTMS 1115 152 S12C	3/8 ~	19	4	11	11.15	15.2	70	12
4BSTMS 1425 224 S16C	1/2 ~, 3/4 ~	14	4	12	14.25	22.4	90	16
4BSTMS 160 285 S16C	1", 1 1/4", 1 1/2", 2"	11	4	12	16	28.5	105	16

# 4NPTM 4 Flutes Pipe Taper Thread Mills for Multi Purpose

## 4날 범용 관용 테이퍼 나사 가공 쓰레드밀

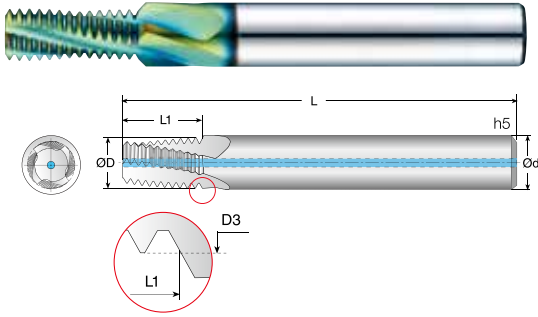

- HRc 48 이하의 고경도강, 프리하든강, 합금강, 탄소강, 주철 가공
- 내부 홀을 통한 효과적인 냉각수 공급이 가능합니다.
- 절삭 영역으로 직접 절삭유를 공급하여 칩의 응착 현상을 제거합니다.
- 낮은 절삭부하를 위해 테이퍼 엔드밀 사용을 권장 합니다.
- 오른나사 및 왼나사 작업이 모두 가능합니다.
- Thread mills for Hardened steels (up to HRc 48), pre-hardened steels, alloy steels, carbon steels, cast irons
- Effective cooling water supply is possible with coolant.
- With coolant, it removes chip sticking.
- Using taper endmill is recommended to reduce cutting wear.
- Both right and left threading are available.

**4** UWC 초미립자 TISIN-S Coating **15°** Helix Angle **R** Rotation **CUTTING DATA** 522P

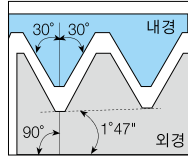

규격 정의 : USAS B2.1:1968  
공차 등급 : 표준 NPT

American UN

단위 Unit: mm

Order Number	피치 규격 Thread	Pitch (TPI)	날수 Flutes Z	산수 Teeth Zt	날경 Diameter D	나사부 길이 Thread Length L1	전장 Overall Length L	샤희 Shank Dia d
<b>외부 급유형 (Without coolant)</b>								
4NPTM 059 098 S06	1/16 ~, 1/8 ~	27	4	10	5.9	9.8	60	6
4NPTM 0765 098 S08	1/8 ~	27	4	10	7.65	9.8	60	8
4NPTM 099 147 S10	1/4 ~, 3/8 ~	18	4	10	9.9	14.7	70	10
4NPTM 1115 147 S12	3/8 ~	18	4	10	11.15	14.7	70	12
4NPTM 1425 189 S16	1/2 ~, 3/4 ~	14	4	10	14.25	18.9	90	16
4NPTM 160 275 S16	1", 1 1/4", 1 1/2", 2"	11.5	4	12	16	27.5	105	16

Order Number	피치 규격 Thread	Pitch (TPI)	날수 Flutes Z	산수 Teeth Zt	날경 Diameter D	나사부 길이 Thread Length L1	전장 Overall Length L	샤희 Shank Dia d
<b>내부 급유형 (With coolant)</b>								
4NPTM 059 098 S06C	1/16 ~, 1/8 ~	27	4	10	5.9	9.8	60	6
4NPTM 0765 098 S08C	1/8 ~	27	4	10	7.65	9.8	60	8
4NPTM 099 147 S10C	1/4 ~, 3/8 ~	18	4	10	9.9	14.7	70	10
4NPTM 1115 147 S12C	3/8 ~	18	4	10	11.15	14.7	70	12
4NPTM 1425 189 S16C	1/2 ~, 3/4 ~	14	4	10	14.25	18.9	90	16
4NPTM 160 275 S16C	1", 1 1/4", 1 1/2", 2"	11.5	4	12	16	27.5	105	16

THREAD MILL

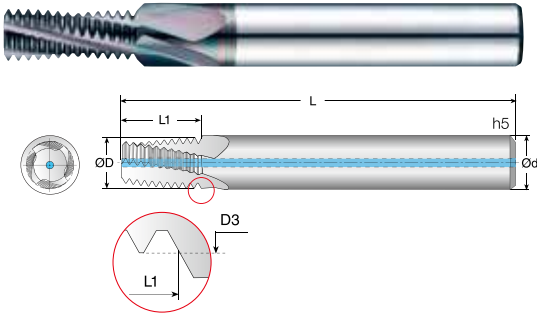

- 알루미늄, 알루미늄 합금 등 비철 비금속 가공
- 내부 홀을 통한 효과적인 냉각수 공급이 가능합니다.
- 절삭 영역으로 직접 절삭유를 공급하여 칩의 응착 현상을 제거합니다.
- 낮은 절삭부하를 위해 테이퍼 엔드밀 사용을 권장 합니다.
- 오른나사 및 왼나사 작업이 모두 가능합니다.

#### Thread mills for Aluminum, Aluminum alloys, non-ferrous, and non-metallic materials

- Effective cooling water supply is possible with coolant.
- With coolant, it removes chip sticking.
- Using taper endmill is recommended to reduce cutting wear.
- Both right and left threading are available.

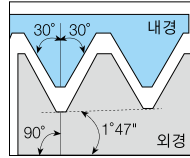

규격 정의 : USAS B2.1:1968  
공차 등급 : 표준 NPT

4
UWC 초미립자
RTAC Coating
15° Helix Angle
R Rotation
CUTTING DATA

American UN

522P

단위 Unit: mm

Order Number	피치 규격 Thread	Pitch (TPI)	날수 Flutes Z	산수 Teeth Zt	날경 Diameter D	나사부 길이 Thread Length L1	전장 Overall Length L	샙크 Shank Dia d
<b>외부 급유형 (Without coolant)</b>								
4NPTMA 059 098 S06	1/16 ~, 1/8 ~	27	4	10	5.9	9.8	60	6
4NPTMA 0765 098 S08	1/8 ~	27	4	10	7.65	9.8	60	8
4NPTMA 099 147 S10	1/4 ~, 3/8 ~	18	4	10	9.9	14.7	70	10
4NPTMA 1115 147 S12	3/8 ~	18	4	10	11.15	14.7	70	12
4NPTMA 1425 189 S16	1/2 ~, 3/4 ~	14	4	10	14.25	18.9	90	16
4NPTMA 160 275 S16	1", 1 1/4", 1 1/2", 2"	11.5	4	12	16	27.5	105	16

<b>내부 급유형 (With coolant)</b>								
Order Number	피치 규격 Thread	Pitch (TPI)	날수 Flutes Z	산수 Teeth Zt	날경 Diameter D	나사부 길이 Thread Length L1	전장 Overall Length L	샙크 Shank Dia d
4NPTMA 059 098 S06C	1/16 ~, 1/8 ~	27	4	10	5.9	9.8	60	6
4NPTMA 0765 098 S08C	1/8 ~	27	4	10	7.65	9.8	60	8
4NPTMA 099 147 S10C	1/4 ~, 3/8 ~	18	4	10	9.9	14.7	70	10
4NPTMA 1115 147 S12C	3/8 ~	18	4	10	11.15	14.7	70	12
4NPTMA 1425 189 S16C	1/2 ~, 3/4 ~	14	4	10	14.25	18.9	90	16
4NPTMA 160 275 S16C	1", 1 1/4", 1 1/2", 2"	11.5	4	12	16	27.5	105	16



# 4NPTMS

4 Flutes Pipe Taper Thread Mills for Stainless Steels

## 4날 SUS 관용 테이퍼 나사 가공 쓰레드밀

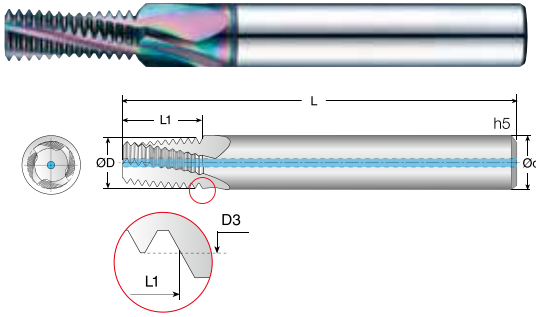

### SUS, 티타늄 합금 가공

- 내부 홀을 통한 효과적인 냉각수 공급이 가능합니다.
- 절삭 영역으로 직접 절삭유를 공급하여 칩의 용착 현상을 제거합니다.
- 낮은 절삭부하를 위해 테이퍼 엔드밀 사용을 권장 합니다.
- 오른나사 및 왼나사 작업이 모두 가능합니다.

### Thread Mills for SUS, Titanium alloys

- Effective cooling water supply is possible with coolant.
- With coolant, it removes chip sticking.
- Using taper endmill is recommended to reduce cutting wear.
- Both right and left threading are available.

4
UWC 초미립자
HR Coating
15° Helix Angle
R Rotation
CUTTING DATA

522P

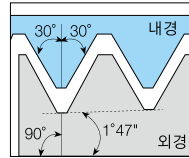

규격 정의 : USAS B2.1:1968  
공차 등급 : 표준 NPT

American UN

단위 Unit: mm

Order Number	피치 규격 Thread	피치 (TPI)	날수 Flutes Z	산수 Teeth Zt	날경 Diameter D	나사부 길이 Thread Length L1	전장 Overall Length L	샙크 Shank Dia d
4NPTMS 059 098 S06	1/16 ~, 1/8 ~	27	4	10	5.9	9.8	60	6
4NPTMS 0765 098 S08	1/8 ~	27	4	10	7.65	9.8	60	8
4NPTMS 099 147 S10	1/4 ~, 3/8 ~	18	4	10	9.9	14.7	70	10
4NPTMS 1115 147 S12	3/8 ~	18	4	10	11.15	14.7	70	12
4NPTMS 1425 189 S16	1/2 ~, 3/4 ~	14	4	10	14.25	18.9	90	16
4NPTMS 160 275 S16	1", 1 1/4", 1 1/2", 2"	11.5	4	12	16	27.5	105	16

### 외부 급유형 (Without coolant)

### 내부 급유형 (With coolant)

4NPTMS 059 098 S06C	1/16 ~, 1/8 ~	27	4	10	5.9	9.8	60	6
4NPTMS 0765 098 S08C	1/8 ~	27	4	10	7.65	9.8	60	8
4NPTMS 099 147 S10C	1/4 ~, 3/8 ~	18	4	10	9.9	14.7	70	10
4NPTMS 1115 147 S12C	3/8 ~	18	4	10	11.15	14.7	70	12
4NPTMS 1425 189 S16C	1/2 ~, 3/4 ~	14	4	10	14.25	18.9	90	16
4NPTMS 160 275 S16C	1", 1 1/4", 1 1/2", 2"	11.5	4	12	16	27.5	105	16



### 4 Flutes Thread Mills for Dental Implants (Three Thread)

## 4날 치과 임플란트 가공 쓰레드밀 (3 나사산)

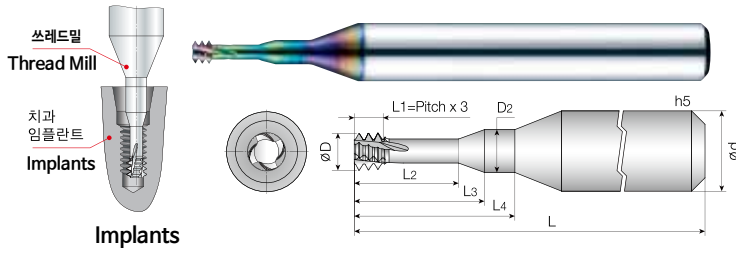

#### • 티타늄, 티타늄 합금 가공

- 경화강 내 나사 가공을 위한 견고하고 강력한 날 디자인.
- 향상된 절삭 및 칩 제거를 통해 공구가 구멍 안에서 끊어지는 위험을 줄입니다.
- 팁 형상은 절삭 저항을 줄이고 공구 구부림을 억제합니다.

#### • Thread Mills for Titanium, Titanium alloys

- Rigid and powerful flutes design for inside hardening steel.
- Enhanced threading enables chip removal smoothly to reduce possible brokage of tool inside hole.
- The shape of tip reduces fraction and prevent tool bending.

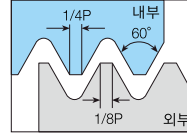

519P

#### ISO 측정항목

단위 Unit: mm

Order Number	피치 규격		날수 Flutes Z	산수 Teeth Zt	날경 Diameter D	목부경 Neck Diameter D2	유효장			전장 Overall Length L	샙크 Shank Dia d
	Thread	Pitch					L2	L3	L4		
<b>외부 급유형 (Without coolant)</b>											
4IMTM 009 025 S03 M012	M1.2	0.25	4	3	0.9	0.95	2.5	3.3	4.3	40	3
4IMTM 0105 028 S03 M014	M1.4	0.3	4	3	1.05	1.1	2.8	3.5	5	40	3
4IMTM 012 033 S03 M016	M1.6	0.35	4	3	1.2	1.25	3.3	4.2	5.9	40	3
4IMTM 014 038 S03 M018	M1.8	0.35	4	3	1.4	1.45	3.8	4.7	6.6	40	3
4IMTM 0154 039 S03 M2	M2	0.4	4	3	1.54	1.7	3.9	4.9	6.7	40	3
4IMTM 0196 048 S03 M025	M2.5	0.45	4	3	1.96	2	4.8	5.8	8.2	40	3



### 4 Flutes Thread Mills for Dental Implants (Three Thread)

## 4날 치과 임플란트 가공 쓰레드밀 (3 나사산)

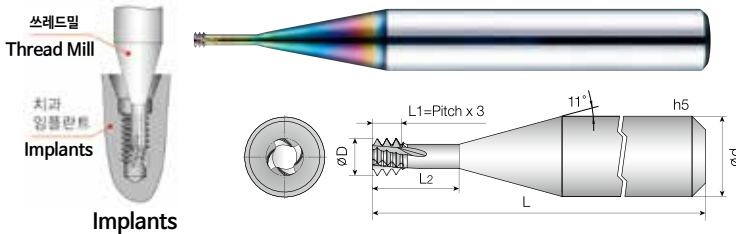

#### • 티타늄, 티타늄 합금 가공

- 경화강 내 나사 가공을 위한 견고하고 강력한 날 디자인.
- 향상된 절삭 및 칩 제거를 통해 공구가 구멍 안에서 끊어지는 위험을 줄입니다.
- 팁 형상은 절삭 저항을 줄이고 공구 구부림을 억제합니다.

#### • Thread Mills for Titanium, Titanium alloys

- Rigid and powerful flutes design for inside hardening steel.
- Enhanced threading enables chip removal smoothly to reduce possible brokage of tool inside hole.
- The shape of tip reduces fraction and prevent tool bending.

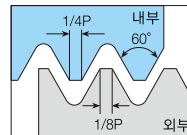

519P

#### ISO 측정항목

단위 Unit: mm

Order Number	피치 규격		날수 Flutes Z	산수 Teeth Zt	날경 Diameter D	유효장 Effective Length L2	전장 Overall Length L	샙크 Shank Dia d
	Thread	Pitch						
<b>외부 급유형 (Without coolant)</b>								
4IMTM 0057 023 S06 M008	M0.8	0.2	4	3	0.57	2.3	50	6
4IMTM 0064 026 S06 M009	M0.9	0.225	4	3	0.64	2.6	50	6
4IMTM 0071 029 S06 M1	M1	0.25	4	3	0.71	2.9	50	6
4IMTM 0091 034 S06 M012	M1.2	0.25	4	3	0.91	3.4	50	6
4IMTM 0105 039 S06 M014	M1.4	0.3	4	3	1.05	3.9	50	6
4IMTM 012 045 S06 M016	M1.6	0.35	4	3	1.2	4.5	50	6
4IMTM 014 050 S06 M018	M1.8	0.35	4	3	1.4	5	50	6
4IMTM 0154 056 S06 M2	M2	0.4	4	3	1.54	5.6	50	6
4IMTM 0184 063 S06 M023	M2.3	0.4	4	3	1.84	6.3	50	6
4IMTM 0198 069 S06 M025	M2.5	0.45	4	3	1.98	6.9	50	6
4IMTM 0208 071 S06 M026	M2.6	0.45	4	3	2.08	7.1	50	6

## 2DM 2DTMS 스레드밀 - 가능한 원인들



스레드 프로파일에 채워지거나 접착 된 칩 (Chips packed or glued at the thread profile)

- 열악한 냉각수 (Poor coolant)
- 냉각제 개선 (즉, 플러드 냉각제, 관통 구멍 용 측면 플루트 냉각제 공급 장치 추가)  
Improve Coolant (i.e add flood coolant, lateral flute coolant supply for thruht holes)
- 냉각수 플루트를 샹크에 추가하십시오.  
Add coolant flutes on shank.

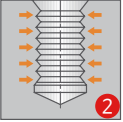

스레드 게이지는 피팅되지 않습니다. (Thread go-gage dosen't fit)

- 스레드가 너무 작음 (thread too small) → 오프셋 레지스터에서 공구 반경 감소 (Reduce tool radius in offset register)
- 스레드에 칩이 있음 (Chip in thread) → 냉각제 개선 (Improve coolant)

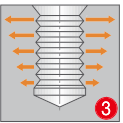

스레드가 점점 가늘어지고 있습니다. (Thread is getting tapered)

- 열악한 공구 클램핑 (Poor tool clamping)
- 공구 홀딩 (즉, 수축 끼워 맞춤 홀더) 개선 Improve tool holding (i.e shrink fit holders)
- 나사산 밀링 피드가 너무 높음 (thread milling feed too high) → 나사산 밀링 피드 감소 (reduce thread milling feed)
- 스레드 가공 횟수를 황삭, 정삭으로 나눠서 가공  
(Machining by dividing the number of thread machining into roughing and finishing)

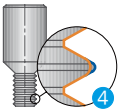

불규칙한 공구 마모 (Erratic tool wear)

- 공구가 너무 많이 소모 됨 → 공구 홀더 (예 : 단축 잠팩 홀더)를 사용하십시오.
- 스레드에 칩이 있음 (Chip in thread) → 냉각제 개선 (Improve coolant)



카운터 보어 칩이 공구 주변에 감겨 있습니다.

- (Counterbore chips are winding around the tool)
- 모따기 피드가 너무 낮음 (Chamfer feed too low)
  - 모따기 피드가 증가합니다. (Increase chamfer feed)



시끄러운 드릴링 노이즈 (특히 최종 드릴링 깊이 방향)

- Loud drilling noise (especially towards the final drilling depth)
- 칩 문제 (Chip problem)
  - 드릴 이송 속도 감소 (reduce drill feed rate)
  - 절삭유가 들어간 공구를 사용하십시오. (Use tool with coolant through)
  - 펍주기 추가 (Add peck cycle)

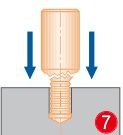

드릴링 중 공구 파손 (특히 긴 칩핑 소재에서)

Tool breakage while drilling (especially in long chipping material)

- 칩 문제 (Chip problem)
- 드릴 이송 속도 감소 (reduce drill feed rate)
- 절삭유가 들어간 공구를 사용하십시오. (Use tool with coolant through)
- 펍주기 추가 (Add peck cycle)



틈새에 붙어있는 칩 (Chips glued up in the flutes)

- 열악한 냉각수 (Poor coolant)
- 냉각제 상황 개선 (Improve coolant situation)
- 절삭유가 들어간 공구를 사용하십시오. (Use tool with coolant through)
- 코팅 공구 사용 (Use coated tool)

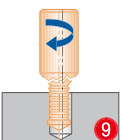

스레드 밀링 중 공구 파손, 공구 파손 (Chippage, tool breakage while thread milling)

- 이송 속도 나사 밀링이 너무 높음 (feed rate thread milling too high)
- 보링 작업 후 칩 그루브에 칩이 없음을 확인하십시오  
Check that the chip grooves are free of chips after the boring operation)
- 진동 (Vibrations)
- 이송 속도 감소 (NC피드가 중심점 또는 외부 트랙과 관련되는지 확인)  
Reduce feed rate (Check whether Nc feeds relate to centre point or external track)



나사 표면이 좋지 않음 (고조파) Poor thread surface (harmonics)

- 진동 (Vibrations)
- 공구 홀더 확인 (모듈러 시스템을 사용하지 마십시오!)  
(Check tool holder (do not use modular systems!))
- 공작물 클램핑 및 픽스처 확인. 클램핑 셋업이 불안정한 곳에서는 절삭력의 분포가 도입됩니다.  
(Check workpiece clamping and fixture. Where the clamping set-up is unstable introduce a distribution of the cutting force.)
- 절단 속도 감소 (reduce cutting speed)
- 치아 이송 속도 증가 (Increase tooth feed rate)
- 절삭력의 분포를 소개 (Introduce distribution of cutting force)

# 나사산 예비 가공 홀 직경 - 탭가공 / 스레드 밀링

## 나사의 종류 및 기호

나사의 종류		기호	나사산 각도	규격	
미터 나사	보통 나사	M	60°	JIS B 0205	
	가는 나사			JIS B 0207	
항공 우주용 미터 나사	보통 나사	MJ	60°	ISO 5855	JIS B 0206
유니파이 나사	보통 나사	UNC	60°	ANSI B1.1	JIS B 0208
	가는 나사	UNF			
	아주 가는 나사	UNEF			
항공 우주용 인치 나사	특수 나사	UNS	60°	MIL-S-8879	
	보통 나사	UNJC			
	가는 나사	UNJF			
	아주 가는 나사	UNJEF			
관용 테이퍼 나사	미국식 관용 테이퍼 나사	NPT	60°	ANSI/ASEM B1.20.1	
	미국식 드라이셸 관용 테이퍼 나사	NPTF		ANSI B1.20.3	
	영국식 관용 테이퍼 나사	PT(Rc)	55°	JIS B 0203	
관용 평행 나사	기계 결합용 관용 평행 나사	PF(G)	55°	JIS B 0202	
	내밀 용 관용 평행 나사	PS(Rp)		JIS B 0203	
영국 위트워스 나사	보통나사	BSW	55°	BS 84	

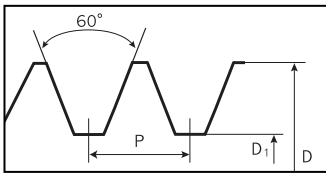

M, UNC, UNF, UNEF 도면

**M** 미터법 ISO 미세 나사산  
DIN 13 및 DIN ISO 965-1

D		D <sub>1</sub>		
직경 Diameter	피치 Pitch	min (mm)	max (mm)	드릴 직경 Drill Dia. (mm)
1	0.25	0.729	0.785	0.75
1.1	0.25	0.829	0.885	0.85
1.2	0.25	0.929	0.985	0.95
1.4	0.3	1.075	1.142	1.1
1.6	0.35	1.221	1.321	1.25
1.7	0.35	1.321	1.421	1.35
1.8	0.35	1.421	1.521	1.45
2	0.25	1.729	1.785	1.75
2	0.4	1.567	1.679	1.6
2.2	0.25	1.929	1.985	1.95
2.2	0.45	1.713	1.838	1.75
2.3	0.25	2.029	2.085	2.05
2.3	0.4	1.813	1.938	1.85
2.5	0.35	2.121	2.221	2.15
2.5	0.45	2.013	2.138	2.05
2.6	0.45	2.113	2.238	2.15
3	0.25	2.729	2.785	2.75
3	0.35	2.621	2.721	2.65
3	0.5	2.459	2.599	2.5
3.5	0.35	3.121	3.221	3.15
3.5	0.6	2.85	3.01	2.9
4	0.35	3.621	3.721	3.65
4	0.5	3.459	3.599	3.5
4	0.7	3.242	3.422	3.3
4.5	0.5	3.959	4.099	4
4.5	0.75	3.688	3.878	3.7
5	0.35	4.621	4.721	4.65
5	0.5	4.459	4.599	4.5
5	0.75	4.188	4.378	4.2
5	0.8	4.134	4.334	4.2

D		D <sub>1</sub>		
직경 Diameter	피치 Pitch	min (mm)	max (mm)	드릴 직경 Drill Dia. (mm)
6	0.5	5.459	5.599	5.5
6	0.75	5.188	5.378	5.25
6	1	4.917	5.153	5
7	0.5	6.459	6.599	6.5
7	0.75	6.188	6.378	6.25
7	1	5.917	6.153	6
8	0.5	7.459	7.599	7.5
8	0.75	7.188	7.378	7.25
8	1	6.917	7.153	7
8	1.25	6.647	6.912	6.8
9	0.75	8.188	8.378	8.25
9	1	7.917	8.153	8
9	1.25	7.647	7.912	7.8
10	0.5	9.459	9.599	9.5
10	0.75	9.188	9.378	9.25
10	1	8.917	9.153	9
10	1.25	8.647	8.912	8.75
10	1.5	8.376	8.676	8.5
11	1	9.917	10.153	10
11	1.5	9.376	9.676	9.5
12	0.5	11.459	11.599	11.5
12	1	10.917	11.153	11
12	1.25	10.647	10.912	10.75
12	1.5	10.376	10.676	10.5
12	1.75	10.106	10.441	10.2
13	1	11.917	12.153	12
14	0.75	13.188	13.378	13.2
14	1	12.917	13.153	13
14	1.25	12.647	12.912	12.75
14	1.5	12.376	12.676	12.5

## 나사산 예비 가공 홀 직경 - 탭가공 / 스레드 밀링

**M** 미터법 ISO 미세 나사산  
DIN 13 및 DIN ISO 965-1

D		D <sub>1</sub>		
직경 Diameter	피치 Pitch	min (mm)	max (mm)	드릴 직경 Drill Dia.(mm)
14	2	11.835	12.21	12
15	1	13.917	14.153	14
15	1.5	13.376	13.676	13.5
16	0.75	15.188	15.378	15.2
16	1	14.917	15.153	15
16	1.25	14.647	14.912	14.8
16	1.5	14.376	14.676	14.5
16	2	13.835	14.21	14
17	1	15.917	16.153	16
18	1	16.917	17.153	17
18	1.5	16.376	16.676	16.5
18	2	15.835	16.21	16
18	2.5	15.294	15.744	15.5
20	1	18.917	19.153	19
20	1.5	18.376	18.676	18.5
20	2	17.835	18.21	18
20	2.5	17.294	17.744	17.5
22	1	20.917	21.153	21
22	1.5	20.376	20.676	20.5
22	2	19.835	20.21	20
22	2.5	19.294	19.744	19.5
24	1.5	22.376	22.676	22.5
24	2	21.835	22.21	22
24	3	20.752	21.252	21
25	1	22.917	23.153	23
25	1.5	23.376	23.676	23.5
26	1.5	24.376	24.676	24.5
27	1	25.917	26.153	26
27	1.5	25.376	25.676	25.5
27	2	24.835	25.21	25
27	3	23.752	24.252	24
28	1.5	26.376	26.676	26.5
28	2	25.835	26.21	26
30	1	28.917	29.153	29
30	1.5	28.376	28.676	28.5
30	2	27.835	28.21	28
30	3.5	26.211	26.771	26.5
32	1.5	30.376	30.676	30.5
32	2	29.835	30.21	30
33	1.5	31.376	31.676	31.5
33	2	30.835	31.21	31
33	3.5	29.211	29.771	29.5
34	1.5	32.376	32.676	32.5
35	1.5	33.376	33.676	33.5
36	1.5	34.376	34.676	34.5
36	2	33.835	34.21	34
36	3	32.752	33.252	33
36	4	31.67	32.27	32
38	1.5	36.376	36.676	36.5
39	1.5	37.376	37.676	37.5
39	2	36.835	37.21	37
39	3	35.752	36.252	36
39	4	34.67	35.27	35
40	1.5	38.376	38.676	38.5
40	2	37.835	38.21	38
40	3	36.752	37.252	37
42	1.5	40.376	40.676	40.5
42	2	39.835	40.21	40
42	3	38.752	37.252	39
42	4.5	37.129	37.799	37.5
45	1.5	43.376	40.676	43.5
45	2	42.835	40.21	43
45	3	41.752	42.252	42
45	4.5	40.129	40.799	40.5

D		D <sub>1</sub>		
직경 Diameter	피치 Pitch	min (mm)	max (mm)	드릴 직경 Drill Dia.(mm)
48	1.5	46.376	46.676	46.5
48	2	45.835	46.21	46
48	3	44.752	45.252	45
48	5	42.587	43.297	43
50	1.5	48.376	48.676	48.5
50	2	47.835	48.21	48
50	3	46.752	47.252	47
52	1.5	50.376	50.676	50.5
52	2	49.835	50.21	50
52	3	46.587	47.087	49
52	5	46.587	47.297	47
56	1.5	54.376	54.676	54.5
56	2	53.835	54.21	54
56	3	52.752	53.252	53
56	5.5	50.046	50.796	50.5
58	1.5	56.376	56.676	56.5
60	1.5	58.376	58.676	58.5
60	2	57.835	58.21	58
60	3	56.752	57.252	57
60	5.5	54.046	54.796	54.5
64	6	57.505	58.305	58
68	6	62.505	62.305	62

**UNC** ASME B1.1에 따른  
보통 나사산

D	D <sub>1</sub>		
직경 Diameter	min (mm)	max (mm)	드릴 직경 Drill Dia.(mm)
1-64 UNC	1.425	1.582	1.55
2-56 UNC	1.694	1.872	1.85
3-48 UNC	1.941	2.146	2.10
4-40 UNC	2.156	2.385	2.35
5-40 UNC	2.487	2.697	2.65
6-32 UNC	2.642	2.896	2.85
8-32 UNC	3.302	3.531	3.50
10-24 UNC	3.683	3.962	3.90
12-24 UNC	4.343	4.597	4.50
1/4-20 UNC	4.976	5.268	5.10
5/16-18 UNC	6.411	6.734	6.60
3/8-16 UNC	7.805	8.164	8.00
7/16-14 UNC	9.149	9.550	9.40
1/2-13 UNC	10.584	11.013	10.80
9/16-12 UNC	11.996	12.456	12.20
5/8-11 UNC	13.376	13.868	13.50
3/4-10 UNC	16.299	16.833	16.50
7/8-9 UNC	19.169	19.748	19.50
1-8 UNC	21.963	22.598	22.25
1 1/8-7 UNC	24.648	25.348	25.00
1 1/4-7 UNC	27.823	28.524	28.00
1 1/2-6 UNC	33.518	34.295	34.00
1 3/4-5 UNC	38.951	39.814	39.50
2-4,5 UNC	44.689	45.598	45.00

## 나사산 예비 가공 홀 직경 - 탭가공 / 스레드 밀링

### UNF ASME B1.1에 따른 미세 나사산

D 직경 Diameter	D <sub>1</sub>		
	min (mm)	max (mm)	드릴 직경 Drill Dia. (mm)
0-80 UNF	1.181	1.306	1.25
1-72 UNF	1.473	1.613	1.55
2-64 UNF	1.755	1.913	1.85
3-56 UNF	2.024	2.197	2.15
4-48 UNF	2.271	2.459	2.40
5-44 UNF	2.550	2.741	2.70
6-40 UNF	2.819	3.023	2.95
8-36 UNF	3.404	3.607	3.50
10-32 UNF	3.962	4.166	4.10
12-28 UNF	4.496	4.724	4.60
1/4-28 UNF	5.367	5.580	5.50
5/16-24 UNF	6.792	7.038	6.90
3/8-24 UNF	8.379	8.626	8.50
7/16-20 UNF	9.738	10.030	9.90
1/2-20 UNF	11.326	11.618	11.50
9/16-18 UNF	12.761	13.084	12.90
5/8-18 UNF	14.348	14.671	14.50
3/4-16 UNF	17.330	17.689	17.50
7/8-14 UNF	20.262	20.663	20.40
1-12 UNF	23.109	23.569	23.25
1 1/8-12 UNF	26.284	26.744	26.50
1 1/4-12 UNF	29.459	29.919	29.50
1 3/8-12 UNF	32.634	33.094	33.00
1 1/2-12 UNF	35.809	36.269	36.10

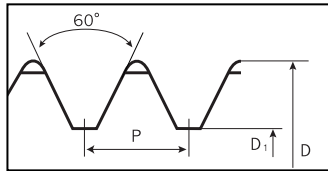

MJ, UNJC, UNJF 도면

### UNJC ASME B1.15 및 ISO 3161에 따른 보통 나사산

D 직경 Diameter	D <sub>1</sub>		
	min (mm)	max (mm)	드릴 직경 Drill Dia. (mm)
1-64 UNJC	1.467	1.570	1.50
2-56 UNJC	1.742	1.860	1.80
3-48 UNJC	1.999	2.137	2.05
4-40 UNJC	2.226	2.391	2.30
5-40 UNJC	2.556	2.721	2.65
6-32 UNJC	2.732	2.938	2.80
8-32 UNJC	3.393	3.599	3.50
10-24 UNJC	3.795	4.064	3.90
12-24 UNJC	4.455	4.704	4.60
1/4-20 UNJC	5.113	5.387	5.20
5/16-18 UNJC	6.563	6.833	6.70
3/8-16 UNJC	7.978	8.255	8.10
7/16-14 UNJC	9.344	9.637	9.50
1/2-13 UNJC	10.796	11.093	10.90
9/16-12 UNJC	12.226	12.480	12.30
5/8-11 UNJC	13.625	13.902	13.70
3/4-10 UNJC	16.575	16.880	16.75

### UNEF

D 직경 Diameter	D <sub>1</sub>		
	min (mm)	max (mm)	드릴 직경 Drill Dia. (mm)
No.12-32 UNEF	4.826	4.623	4.70
1/4-32 UNEF	5.689	5.487	5.60
5/16-32	7.264	7.087	7.10
3/8-32	8.864	8.662	8.70
7/16-28	10.337	10.135	10.20
1/2-28	11.938	11.710	11.80
9/16-24	13.385	13.132	13.20
5/8-24	14.986	14.732	14.80
3/4-20	17.957	17.679	17.80
7/8-20	21.132	20.854	21.00
1-20	24.307	24.029	24.10
1 1/8-18	27.381	27.051	27.20
1 1/4-18	30.556	30.226	30.30
1 3/8-18	33.731	33.401	33.50
1 1/2-18	36.906	36.576	36.70
1 5/8-18	40.081	39.751	39.80

### MJ DIN ISO 5855에 따른 표준 나사산

D 직경 Diameter	피치 Pitch	D <sub>1</sub>		
		min (mm)	max (mm)	드릴 직경 Drill Dia. (mm)
MJ3	0.5	2.513	2.653	2.6
MJ4	0.7	3.318	3.498	3.4
MJ5	0.8	4.221	4.421	4.3
MJ6	1	5.026	5.215	5.1
MJ8	1.25	6.782	6.994	6.9
MJ10	1.5	8.539	8.779	8.7
MJ12	1.75	10.295	10.563	10.5
MJ16	2	14.051	14.351	14.3

### UNJF ASME B1.15 및 ISO 3161에 따른 미세 나사산

D 직경 Diameter	D <sub>1</sub>		
	min (mm)	max (mm)	드릴 직경 Drill Dia. (mm)
0-80 UNJF	1.215	1.297	1.25
1-72 UNJF	1.510	1.602	1.55
2-64 UNJF	1.797	1.900	1.85
3-56 UNJF	2.073	2.191	2.10
4-48 UNJF	2.329	2.467	2.40
5-44 UNJF	2.613	2.763	2.70
6-40 UNJF	2.886	3.051	2.95
8-36 UNJF	3.479	3.662	3.60
10-32 UNJF	4.053	4.253	4.15
12-28 UNJF	4.602	4.815	4.70
1/4-28 UNJF	5.466	5.662	5.60
5/16-24 UNJF	6.907	7.110	7.00
3/8-24 UNJF	8.494	8.680	8.60
7/16-20 UNJF	9.875	10.083	10.00
1/2-20 UNJF	11.463	11.660	11.50
9/16-18 UNJF	12.913	13.123	13.00
5/8-18 UNJF	14.500	14.702	14.50

## 나사산 예비 가공 홀 직경 - 탭가공 / 스레드 밀링

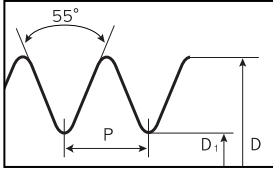

PF(G), PS(Rp), BSW

**PF(G)** DIN EN ISO 228에 따른 관용 나사산

D 직경 Diameter	D <sub>1</sub>		
	min (mm)	max (mm)	드릴 직경 Drill Dia. (mm)
PF(G) 1/16-28	6.561	6.843	6.80
PF(G) 1/8-28	8.566	8.848	8.80
PF(G) 1/4-19	11.445	11.890	11.80
PF(G) 3/8-19	14.950	15.395	15.25
PF(G) 1/2-14	18.632	19.173	19.00
PF(G) 5/8-14	20.588	21.129	21.00
PF(G) 3/4-14	24.118	24.659	24.50
PF(G) 7/8-14	27.878	28.419	28.25
PF(G) 1-11	30.292	30.932	30.75
PF(G) 1 1/8-11	34.940	35.580	35.50
PF(G) 1 1/4-11	38.953	39.593	39.50
PF(G) 1 3/8-11	41.366	42.006	41.90
PF(G) 1 1/2-11	44.846	45.486	45.25
PF(G) 1 3/4-11	50.789	51.429	51.00
PF(G) 2-11	56.657	57.297	57.00
PF(G) 2 1/4-11	62.753	63.393	63.00
PF(G) 2 1/2-11	72.227	72.867	72.60
PF(G) 3-11	84.927	85.567	85.00

**BSW** BS 84에 따른 Whitworth 나사산

D 직경 Diameter	D <sub>1</sub>		
	min (mm)	max (mm)	드릴 직경 Drill Dia. (mm)
1/16-60	1.045	1.231	1.2
3/32-48	1.703	1.911	1.9
1/8-40	2.362	2.59	2.5
5/32-32	2.952	3.213	3.1
3/16-24	3.407	3.745	3.6
7/32-24	4.201	4.539	4.5
1/4-20	4.724	5.155	5
5/16-18	6.131	6.591	6.5
3/8-16	7.493	7.988	7.9
7/16-14	8.79	9.33	9.2
1/2-12	9.989	10.59	10.5
9/16-12	11.577	12.178	12
5/8-11	12.919	13.558	13.4
3/4-10	15.798	16.484	16.4
7/8-9	18.612	19.354	19.25
1-8	21.335	22.148	22
1 1/8-7	23.929	24.833	24.75
1 1/4-7	27.104	28.008	27.5
1 3/8-6	29.505	30.529	30
1 1/2-6	32.68	33.704	33.5
1 5/8-5	34.771	35.965	35.5
1 3/4-5	37.946	39.14	39
1 7/8-4.5	40.398	41.705	41.5
2-4 1/2	43.573	44.88	44.5
2 1/4-4	49.02	50.468	50
2 1/2-4	55.37	56.818	56

**PS(Rp)** DIN EN10226-1에 따른 Whitworth 관용 나사산

D 직경 Diameter	D <sub>1</sub>		
	min (mm)	max (mm)	드릴 직경 Drill Dia. (mm)
PS(Rp) 1/16-28	6.490	6.632	6.55
PS(Rp) 1/8-28	8.495	8.637	8.60
PS(Rp) 1/4-19	11.341	11.549	11.50
PS(Rp) 3/8-19	14.846	15.054	15.00
PS(Rp) 1/2-14	18.490	18.774	18.50
PS(Rp) 5/8-14	20.446	20.73	20.50
PS(Rp) 3/4-14	23.976	24.26	24.00
PS(Rp) 1-11	30.112	30.472	30.25
PS(Rp) 1 1/4-11	38.773	39.133	39.00
PS(Rp) 1 1/2-11	44.629	45.063	45.00
PS(Rp) 2-11	56.440	56.874	56.50
PS(Rp) 2 1/2-11	72.010	72.444	72.20
PS(Rp) 3-11	84.710	85.144	85.00

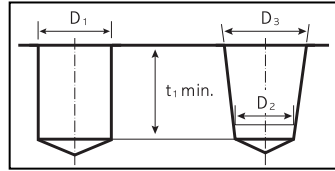

NPT, NPTF 도면

**NPT** ASME B1.20.1에 따른 관용 표준 나사산, 테이퍼 1:16

D 직경 Diameter	D <sub>1</sub>			
	D <sub>1</sub>	D <sub>2</sub>	D <sub>3</sub>	T <sub>1</sub>
1/16-27 NPT	6.150	5.950	6.39	10.7
1/8-27 NPT	8.400	8.310	8.74	10.8
1/4-18 NPT	11.100	10.730	11.36	15.6
3/8-18 NPT	14.300	14.150	14.80	16.0
1/2-14 NPT	17.900	17.470	18.32	20.8
3/4-14 NPT	23.300	22.790	23.67	21.3
1-11 1/2 NPT	29.000	28.640	29.69	25.6
1 1/4-11 1/2 NPT	37.700	3.370	38.45	26.1
1 1/2-11 1/2 NPT	43.700	43.440	44.52	26.1
2-11 1/2 NPT	55.600	55.450	56.56	26.5
2 1/2-8 NPT	66.300	66.140	67.62	36.3
3-8 NPT	82.300	81.900	83.52	38.5

**NPTF** ASME B1.20.3에 따른 미국 관용 표준 나사산, 테이퍼 1:16

D 직경 Diameter	D <sub>1</sub>			
	D <sub>1</sub>	D <sub>2</sub>	D <sub>3</sub>	T <sub>1</sub>
1/16-27 NPTF	6.1	5.97	6.41	10.3
1/8-27 NPTF	8.4	8.33	8.77	10.3
1/4-18 NPTF	11.0	10.77	11.40	15.0
3/8-18 NPTF	14.5	14.19	14.84	15.3
1/2-14 NPTF	17.5	17.48	18.33	19.9
3/4-14 NPTF	23.0	22.84	23.72	20.4
1-11 1/2 NPTF	29.0	28.62	29.76	24.5
1 1/4-11 1/2 NPTF	37.5	37.44	38.52	25.0
1 1/2-11 1/2 NPTF	43.5	43.50	44.59	25.0
2-11 1/2 NPTF	56.0	55.51	56.62	25.4
2 1/2-8 NPTF	66.0	66.03	67.71	38.0
3-8 NPTF	82.0	81.80	83.62	40.0

# 나사직경 규격안내

헬리코일 타입 사용을 위한 나사의 직경 Thread diameter to use heli coil type.

## 유니파이 계열 나사직경(와이어 프레임)\_ UNC

SIZE	T.P.I	B inch MAJ DIA	mm 환산시
NO. 2	56	0.1092	2.7737
NO. 3	48	0.1261	3.2029
NO. 4	40	0.1445	3.6703
NO. 5	40	0.1575	4.0005
NO. 6	32	0.1786	4.5364
NO. 8	32	0.2046	5.1968
NO. 10	24	0.2441	6.2001
NO. 12	24	0.2701	6.8605
1/4	20	0.315	8.001
5/16	18	0.3847	9.7714
3/8	16	0.4562	11.5875
7/16	14	0.5303	13.4696
1/2	13	0.5999	15.2375
9/16	12	0.6708	17.0383
5/8	11	0.7431	18.8747
3/4	10	0.8799	22.3495
7/8	9	1.0193	25.8902
1	8	1.1624	29.525
1 1/8	7	1.3106	33.2892
1 1/4	7	1.4356	36.4642
1 3/8	6	1.5914	40.4216
1 1/2	6	1.7164	43.5966

## 유니파이 계열 나사직경(와이어 프레임)\_ UNF

SIZE	T.P.I	B inch MAJ DIA	mm 환산시
NO. 3	56	0.1092	2.7737
NO. 4	48	0.1261	3.2029
NO. 5	44	0.1445	3.6703
NO. 6	40	0.1575	4.0005
NO. 8	36	0.1786	4.5364
NO. 10	32	0.2046	5.1968
1/4	28	0.2441	6.2001
5/16	24	0.2701	6.8605
3/8	24	0.315	8.001
7/16	20	0.3847	9.7714
1/2	20	0.4562	11.5875
9/16	18	0.5303	13.4696
5/8	18	0.5999	15.2375
3/4	16	0.6708	17.0383
7/8	14	0.7431	18.8747
1	12	0.8799	22.3495
1 1/8	12	1.0193	25.8902
1 1/4	12	1.1624	29.525
1 3/8	12	1.3106	33.2892
1 1/2	12	1.4356	36.4642

## 밀리미터(mm) 계열 나사직경(와이어 프레임)

SIZE	C MM
M2 x 0.4	2.520
M2.2 x 0.45	2.785
M2.5 x 0.45	3.085
M3 x 0.5	3.650
M3.5 x 0.6	4.279
M4 x 0.7	4.909
M5 x 0.8	6.039
M6 x 1.0	7.299
M7 x 1.0	8.299
M8 x 1.0	9.299
M8 x 1.25	9.624
M9 x 1.25	10.624
M10 x 1.25	11.624
M10 x 1.5	11.949
M11 x 1.5	12.949
M12 x 1.25	13.624
M12 x 1.5	14.131
M12 x 1.75	14.273
M14 x 1.5	15.949
M14 x 2.0	16.598
M16 x 1.5	17.949
M16 x 2.0	18.598
M18 x 1.5	19.949
M18 x 2.0	20.598
M18 x 2.5	21.248
M20 x 1.5	21.949
M20 x 2.0	22.598
M20 x 2.5	23.248
M22 x 1.5	23.949
M22 x 2.0	24.598
M22 x 2.5	25.248
M24 x 2.0	26.598
M24 x 3.0	27.897
M27 x 3.0	30.897
M30 x 3.5	34.547
M33 x 3.5	37.547
M36 x 4.0	41.196



피삭재 Material		합금강/프리하드강 Alloy Steels / Pre-hardened Steels NAK80 / KP4M				고경도강 Hardened Steels STAVAX / SKD11				열처리 / 고경도강 Heat-treated steels / Hardened Steels YXR7 / SKH51			
경도 Hardness		40 ~ 45HRc				45 ~ 55HRc				55 ~ 62HRc			
반경 Radius	유효장 Effective Length	RPM	FEED	Ap Axial Depth	Ae Radial Depth	RPM	FEED	Ap Axial Depth	Ae Radial Depth	RPM	FEED	Ap Axial Depth	Ae Radial Depth
R0.1	0.2	50,000	326	0.005	0.005	50,000	216	0.004	0.004	50,000	120	0.003	0.003
"	0.5	50,000	308	0.004	0.004	50,000	198	0.003	0.003	50,000	110	0.002	0.003
R0.15	0.3	50,000	800	0.006	0.010	50,000	520	0.004	0.005	50,000	410	0.003	0.005
"	0.5	50,000	720	0.006	0.010	50,000	450	0.003	0.005	50,000	390	0.003	0.005
"	1	50,000	650	0.006	0.010	50,000	410	0.003	0.005	50,000	350	0.003	0.004
R0.2	0.3	50,000	1,120	0.010	0.010	50,000	750	0.005	0.006	50,000	650	0.005	0.005
"	1	50,000	1,050	0.010	0.010	50,000	710	0.005	0.005	50,000	600	0.005	0.005
"	3	50,000	540	0.005	0.005	50,000	360	0.003	0.003	50,000	310	0.002	0.003
R0.25	0.4	50,000	1,420	0.010	0.020	50,000	1,210	0.005	0.010	50,000	1,030	0.005	0.010
"	1	50,000	1,290	0.010	0.015	50,000	1,100	0.005	0.010	50,000	980	0.005	0.010
"	3	50,000	1,090	0.010	0.015	50,000	850	0.005	0.010	50,000	730	0.005	0.010
R0.3	0.5	50,000	2,300	0.020	0.020	50,000	1,890	0.015	0.015	50,000	1,520	0.010	0.010
"	1	50,000	2,180	0.020	0.020	50,000	1,760	0.010	0.010	50,000	1,490	0.010	0.010
"	3	40,000	1,300	0.015	0.020	40,000	1,060	0.010	0.010	40,000	870	0.010	0.010
"	5	30,000	650	0.015	0.015	30,000	590	0.010	0.010	30,000	390	0.005	0.005
R0.4	0.6	50,000	2,600	0.020	0.030	50,000	1,980	0.020	0.020	50,000	1,720	0.010	0.020
"	2	40,000	2,100	0.015	0.020	40,000	1,450	0.015	0.015	40,000	1,210	0.010	0.010
"	4	30,000	1,540	0.015	0.015	30,000	940	0.010	0.015	30,000	840	0.010	0.010
"	8	24,000	970	0.010	0.010	24,000	650	0.005	0.010	24,000	470	0.005	0.005
R0.5	1.5	40,000	2,560	0.030	0.040	40,000	1,980	0.020	0.030	40,000	1,590	0.020	0.020
"	3	30,000	2,100	0.030	0.030	30,000	1,650	0.020	0.030	30,000	1,240	0.020	0.020
"	5	30,000	1,700	0.030	0.030	30,000	1,360	0.015	0.020	30,000	1,080	0.010	0.015
"	10	25,000	780	0.015	0.015	25,000	620	0.010	0.015	16,000	500	0.010	0.010
R0.75	2	40,000	2,300	0.040	0.040	40,000	1,920	0.030	0.030	40,000	1,530	0.020	0.030
"	4	30,000	2,010	0.030	0.030	30,000	1,600	0.025	0.025	30,000	1,280	0.020	0.020
"	8	30,000	1,700	0.030	0.030	30,000	1,360	0.020	0.020	30,000	1,080	0.010	0.010
R1	2	40,000	3,310	0.050	0.050	40,000	2,640	0.040	0.040	40,000	2,110	0.030	0.040
"	6	40,000	3,020	0.030	0.040	40,000	2,410	0.030	0.030	40,000	1,930	0.020	0.030
"	10	24,000	1,210	0.020	0.030	24,000	970	0.010	0.030	24,000	770	0.010	0.020
"	14	16,000	920	0.010	0.020	16,000	780	0.010	0.010	16,000	630	0.010	0.010
R1.5	3	40,000	2,500	0.030	0.040	40,000	2,000	0.030	0.030	40,000	1,600	0.020	0.030
"	6	32,000	2,100	0.030	0.030	32,000	1,680	0.020	0.030	32,000	1,340	0.020	0.030
"	10	21,000	1,700	0.020	0.030	21,000	1,360	0.020	0.020	21,000	1,080	0.010	0.020
"	16	16,000	1,100	0.020	0.030	16,000	880	0.010	0.020	16,000	700	0.010	0.010
R2	4	40,000	2,100	0.030	0.040	40,000	1,680	0.030	0.030	40,000	1,340	0.020	0.030
"	10	21,000	1,620	0.020	0.030	21,000	1,290	0.020	0.020	21,000	1,030	0.010	0.020
"	16	16,000	1,060	0.010	0.020	16,000	840	0.010	0.020	16,000	670	0.010	0.010
R3		16,000~50,000	960~3,000	0.050	0.060	13,000~50,000	780~2,000	0.050	0.060	11,000~50,000	540~1,500	0.050	0.060

**절입량**  
Depth of Cut

Ap : Axial Depth 축 방향의 절입 깊이(mm)  
 Ae : Radial Depth 반경 방향의 절입 깊이(mm)  
 D : Outside Diameter 외경(mm)  
 n : Speed 회전 속도 (min<sup>-1</sup>)  
 Vf : Feed 이송 속도 (mm/min)

- HRC68 이상 고경도강 가공 시 같은 직경의 같은 비율로 20% DOWN 시켜주십시오.
- 상기 절삭조건은 참고 수치이므로 실제 가공시에는 가공 형상, 가공 목적, 적용 기계 등에 따라 조건을 조정 하십시오.
- 절삭조건이 없는 유효장은 비슷한 유효장에 비례하여 사용 하십시오.
- 길이가 긴 엔드밀의 경우 떨림, 이상음이 발생할 경우에는 상기의 회전속도와 이송속도를 같은 비율로 내려서 사용해 주십시오.
- In case machining Hardened steel HRC upper 68, reduce 20% of cutting parameter on the table.
- Use this table for your reference. Adjust the parameters depending on your machining geometry, machining purpose and CNC.
- If there is no effective length of your endmill on the table, use a similar type of effective length and apply the same proportion.
- In case of long length endmill shaking or abnormal sound, lower the rotation speed and feed speed of the table above by the same ratio.

피삭재 Material		합금강/프리하드강 Alloy Steels / Pre-hardened Steels NAK80 / KP4M				고경도강 Hardened Steels STAVAX / SKD11				열처리 / 고경도강 Heat-treated steels / Hardened Steels YXR7 / SKH51			
경도 Hardness		40 ~ 45HRc				45 ~ 55HRc				55 ~ 62HRc			
외경 Outside Diameter	유효장 Effective Length	RPM	FEED	Ap Axial Depth	Ae Radial Depth	RPM	FEED	Ap Axial Depth	Ae Radial Depth	RPM	FEED	Ap Axial Depth	Ae Radial Depth
∅ 0.2	0.2	50,000	211	0.005	0.005	50,000	140	0.004	0.004	50,000	78	0.003	0.003
"	0.5	50,000	200	0.004	0.004	50,000	130	0.003	0.003	50,000	71	0.002	0.003
∅ 0.3	0.3	50,000	520	0.006	0.010	50,000	290	0.004	0.005	50,000	260	0.003	0.005
"	0.5	50,000	460	0.006	0.010	50,000	270	0.003	0.005	50,000	250	0.003	0.005
"	1	50,000	422	0.006	0.010	50,000	260	0.003	0.005	50,000	220	0.003	0.004
∅ 0.4	0.3	50,000	840	0.010	0.010	50,000	490	0.005	0.006	50,000	430	0.005	0.005
"	1	50,000	690	0.010	0.010	50,000	470	0.005	0.005	50,000	420	0.005	0.005
"	2	50,000	370	0.005	0.005	50,000	240	0.003	0.003	50,000	209	0.002	0.003
∅ 0.5	0.4	50,000	940	0.010	0.020	50,000	810	0.005	0.010	50,000	732	0.005	0.010
"	1	50,000	850	0.010	0.015	50,000	560	0.005	0.010	50,000	523	0.005	0.010
"	3	50,000	560	0.010	0.015	50,000	530	0.005	0.010	50,000	504	0.005	0.010
∅ 0.8	0.6	50,000	1,530	0.020	0.020	50,000	1,254	0.015	0.015	50,000	1,083	0.010	0.010
"	2	50,000	1,440	0.020	0.020	50,000	1,169	0.010	0.010	50,000	1,064	0.010	0.010
"	4	40,000	860	0.015	0.020	40,000	703	0.010	0.010	40,000	620	0.010	0.010
"	6	30,000	440	0.015	0.015	30,000	390	0.010	0.010	30,000	280	0.005	0.005
∅ 1	0.7	50,000	1,730	0.020	0.030	50,000	1,311	0.020	0.020	50,000	1,230	0.010	0.020
"	2	40,000	1,390	0.015	0.020	40,000	960	0.015	0.015	40,000	870	0.010	0.010
"	4	30,000	1,030	0.015	0.015	30,000	620	0.010	0.015	30,000	600	0.010	0.010
"	8	24,000	650	0.010	0.010	24,000	440	0.005	0.010	24,000	340	0.005	0.005
∅ 1.5	0.8	40,000	1,700	0.030	0.040	40,000	1,090	0.020	0.030	40,000	1,130	0.020	0.020
"	2	30,000	1,400	0.030	0.030	30,000	1,100	0.020	0.030	30,000	880	0.020	0.020
"	4	30,000	1,130	0.030	0.030	30,000	900	0.015	0.020	30,000	770	0.010	0.015
"	8	16,000	520	0.015	0.015	16,000	410	0.010	0.015	16,000	350	0.010	0.010
∅ 2	2	40,000	1,530	0.040	0.040	40,000	1,270	0.030	0.030	40,000	1,090	0.020	0.030
"	4	30,000	1,330	0.030	0.030	30,000	1,060	0.025	0.025	30,000	910	0.020	0.020
"	8	26,000	1,130	0.030	0.030	26,000	900	0.020	0.025	26,000	770	0.010	0.010
∅ 2.5	1.2	40,000	2,200	0.050	0.050	40,000	1,760	0.040	0.040	40,000	1,500	0.030	0.040
"	4	40,000	1,540	0.030	0.040	40,000	1,240	0.030	0.030	40,000	1,150	0.020	0.030
"	10	24,000	810	0.020	0.030	24,000	650	0.010	0.030	24,000	260	0.010	0.020
∅ 3	6	40,000	1,400	0.030	0.030	40,000	1,120	0.020	0.030	40,000	960	0.020	0.030
"	10	21,000	1,130	0.020	0.030	21,000	900	0.020	0.020	21,000	770	0.010	0.020
"	16	16,000	730	0.020	0.030	16,000	590	0.010	0.020	16,000	500	0.010	0.010
∅ 4	6	40,000	1,430	0.030	0.040	40,000	1,120	0.030	0.030	40,000	1,040	0.020	0.030
"	10	21,000	1,080	0.020	0.030	21,000	850	0.020	0.020	21,000	740	0.010	0.020
"	16	16,000	700	0.010	0.020	21,000	560	0.010	0.020	16,000	470	0.010	0.010
∅ 6		16,000~ 50,000	740~ 3,000	0.050	0.060	13,000~ 50,000	590~ 2,000	0.050	0.060	11,000~ 50,000	390~ 1,500	0.050	0.060

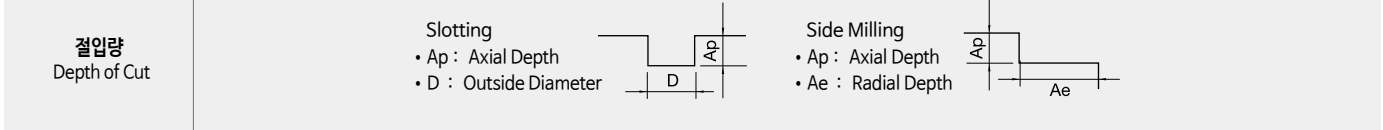

- 날 끝이 정밀하게 연삭되어 있습니다. 파손을 피하기 위해 가능하면 비접촉 방식으로 측정하십시오.
- HRC68 이상 고경도강 가공 시 같은 직경의 같은 비율로 20% DOWN 시켜주십시오.
- 상기 절삭조건은 참고 수치이므로 실제 가공시에는 가공 형상, 가공 목적, 적용 기계 등에 따라 조건을 조정하십시오.
- 절삭조건이 없는 유효장은 비슷한 유효장에 비례하여 사용하십시오.
- 길이가 긴 엔드밀의 경우 떨림, 이상음이 발생할 경우에는 상기표의 회전속도와 이송속도를 같은 비율로 내려서 사용해 주십시오.
- The edge of the flute precisely grinded. If you want to measure the tool, and to avoid damaging on the flutes, use non-contact measuring method.
- In case machining Hardened steel HRC upper 68, reduce 20% of cutting parameter on the table.
- Use this table for your reference. Adjust the parameters depending on your machining geometry, machining purpose and CNC.
- If there is no effective length of your endmill on the table, use a similar type of effective length and apply the same proportion.
- In case of long length endmill shaking or abnormal sound, lower the rotation speed and feed speed of the table above by the same ratio.

피삭재 Material		합금강/프리하드강 Alloy Steels / Pre-hardened Steels NAK80 / KP4M				고경도강 Hardened Steels STAVAX / SKD11				열처리 / 고경도강 Heat-treated steels / Hardened Steels YXR7 / SKH51			
경도 Hardness		40 ~ 45HRc				45 ~ 55HRc				55 ~ 62HRc			
외경 Outside Diameter	유효장 Effective Length	RPM	FEED	Ap Axial Depth	Ae Radial Depth	RPM	FEED	Ap Axial Depth	Ae Radial Depth	RPM	FEED	Ap Axial Depth	Ae Radial Depth
∅ 0.4	0.3	50,000	890	0.010	0.010	50,000	520	0.005	0.006	50,000	450	0.005	0.005
"	1	50,000	730	0.010	0.010	50,000	500	0.005	0.005	50,000	430	0.005	0.005
"	2	50,000	390	0.005	0.005	50,000	250	0.003	0.003	50,000	220	0.002	0.003
∅ 0.5	0.4	50,000	990	0.010	0.020	50,000	850	0.005	0.010	50,000	770	0.005	0.010
"	1	50,000	900	0.010	0.015	50,000	590	0.005	0.010	50,000	550	0.005	0.010
"	3	50,000	630	0.010	0.015	50,000	560	0.005	0.010	50,000	530	0.005	0.010
∅ 0.8	0.6	50,000	1,610	0.020	0.020	50,000	1,320	0.015	0.015	50,000	1,140	0.010	0.010
"	2	50,000	1,520	0.020	0.020	50,000	1,230	0.010	0.010	50,000	1,120	0.010	0.010
"	4	40,000	910	0.015	0.020	40,000	740	0.010	0.010	40,000	650	0.010	0.010
"	6	30,000	460	0.015	0.015	30,000	410	0.010	0.010	30,000	290	0.005	0.005
∅ 1	0.7	50,000	1,820	0.020	0.030	50,000	1,380	0.020	0.020	50,000	1,290	0.010	0.020
"	2	40,000	1,470	0.015	0.020	40,000	1,010	0.015	0.015	40,000	910	0.010	0.010
"	4	30,000	1,080	0.015	0.015	30,000	660	0.010	0.015	30,000	630	0.010	0.010
"	8	24,000	680	0.010	0.010	24,000	460	0.005	0.010	24,000	360	0.005	0.005
∅ 1.5	0.8	40,000	1,790	0.030	0.040	40,000	1,150	0.020	0.030	40,000	1,190	0.020	0.020
"	2	30,000	1,470	0.030	0.030	30,000	1,160	0.020	0.030	30,000	930	0.020	0.020
"	4	30,000	1,190	0.030	0.030	30,000	950	0.015	0.020	30,000	810	0.010	0.015
"	8	24,000	550	0.015	0.015	24,000	430	0.010	0.015	24,000	370	0.010	0.010
∅ 2	2	40,000	1,610	0.040	0.040	40,000	1,340	0.030	0.030	40,000	1,150	0.020	0.030
"	4	30,000	1,400	0.030	0.030	30,000	1,120	0.025	0.025	30,000	960	0.020	0.020
"	8	30,000	1,190	0.030	0.030	30,000	950	0.020	0.030	30,000	810	0.010	0.010
∅ 2.5	1.2	40,000	2,317	0.050	0.050	40,000	1,850	0.040	0.040	40,000	1,580	0.030	0.040
"	4	40,000	1,620	0.030	0.040	40,000	1,300	0.030	0.030	40,000	1,210	0.020	0.030
"	10	24,000	850	0.020	0.030	24,000	680	0.010	0.030	24,000	280	0.010	0.020
∅ 3	6	40,000	1,470	0.030	0.030	40,000	1,180	0.020	0.030	40,000	1,010	0.020	0.030
"	10	21,000	1,190	0.020	0.030	21,000	950	0.020	0.020	21,000	810	0.010	0.020
"	16	16,000	770	0.020	0.030	16,000	620	0.010	0.020	16,000	530	0.010	0.010
∅ 4	6	40,000	1,510	0.030	0.040	40,000	1,180	0.030	0.030	40,000	1,100	0.020	0.030
"	10	21,000	1,140	0.020	0.030	21,000	900	0.020	0.020	21,000	780	0.010	0.020
"	16	16,000	740	0.010	0.020	16,000	590	0.010	0.020	16,000	500	0.010	0.010
∅ 6		16,000~ 50,000	740~ 3,000	0.050	0.060	13,000~ 50,000	590~ 2,000	0.050	0.060	11,000~ 50,000	390~ 1,500	0.050	0.060

**절입량**  
Depth of Cut

• Ap : Axial Depth  
• Ae : Radial Depth

- HRC68 이상 고경도강 가공 시 같은 직경의 같은 비율로 20% DOWN 시켜주십시오.
- 유효장이 긴 경우에는 회전수와 이송속도를 최대30% 이하로 줄이십시오.
- 4날 사용시 Feed 20% 증가, 절입량을 5% 감소하여 사용 하십시오.
- 측면 절삭시 코너R 부분과 각도 내용을 참고하여 절삭 하시기 바랍니다.
- 곡면 절삭시 날경의 코너R 보다 낮은 이동 PITCH를 설정 하십시오.
- 곡면 절삭시 안정적인 속도 내에서 피드를 최대 30%까지 UP 해주십시오.
- 상기 절삭조건은 참고 수치이므로 실 가공시에는가공형상, 가공 목적, 적용 기계 등에 따라 조건을 조정 하십시오.
- 절삭조건이 없는 유효장은 비슷한 유효장에 비례하여 사용 하십시오.
- 길이가 긴 엔드밀의 경우 떨림, 이상음이 발생할 경우에는 상기표의 회전속도와 이송속도를 같은 비율로 내려서 사용해 주십시오.
- In case machining Hardened steel HRC upper 68, reduce 20% of cutting parameter on the table.
- In case of long effective length, reduce the RPM and feed by 30% or less.
- For using 4 flutes, reduce the feed by 20% and the depth of cut by 5%.
- For side milling, refer to the corner R section and the angle.
- For curved milling, set up a pitch below than corner radius of the tool diameter.
- For curved milling, raise the feed upto 30% at a stable speed.
- Use this table for your reference. Adjust the parameters depending on your machining geometry, machining purpose and CNC.
- If there is no effective length of your endmill on the table, use a similar type of effective length and apply the same proportion.
- In case of long length endmill shaking or abnormal sound, lower the rotation speed and feed speed of the table above by the same ratio.

피삭재 Material		고경도강 Hardened Steels STAVX / SKD11				열처리 / 고경도강 Heat-treated steels / Hardened Steels SKD11 / SKD61				열처리 / 고경도강 Heat-treated steels / Hardened Steels YXR7 / SKH51			
경도 Hardness		45 ~ 55HRC				55 ~ 62HRC				62 ~ 70HRC			
반경 Radius	유효장 Effective Length	RPM	FEED	Ap Axial Depth	Ae Radial Depth	RPM	FEED	Ap Axial Depth	Ae Radial Depth	RPM	FEED	Ap Axial Depth	Ae Radial Depth
R 0.1	0.5	60,000	176	0.002	0.005	66,000	104	0.002	0.005	49,500	52	0.002	0.005
"	1	60,000	176	0.002	0.005	66,000	104	0.002	0.005	49,500	52	0.002	0.005
"	1.5	48,000	70	0.001	0.003	52,000	52	0.001	0.003	39,600	24	0.001	0.003
"	2	48,000	44	0.001	0.003	52,000	32	0.001	0.003	39,600	16	0.001	0.003
R 0.15	1	45,000	273	0.004	0.010	47,850	144	0.003	0.008	35,750	72	0.003	0.008
"	1.5	45,000	273	0.004	0.010	47,850	144	0.003	0.008	35,750	72	0.003	0.008
"	2	45,000	167	0.003	0.008	47,850	88	0.002	0.005	35,750	44	0.002	0.005
"	3	32,000	70	0.002	0.005	35,200	52	0.001	0.003	26,400	24	0.001	0.003
R 0.2	1	37,500	370	0.007	0.018	38,500	192	0.005	0.013	28,875	96	0.005	0.013
"	2	37,500	370	0.007	0.018	38,500	192	0.005	0.013	28,875	96	0.005	0.013
"	3	31,900	185	0.004	0.010	33,550	128	0.003	0.008	25,080	64	0.002	0.005
"	4	25,500	132	0.002	0.005	26,730	96	0.002	0.005	20,020	48	0.002	0.005
R 0.25	1	33,000	466	0.010	0.025	33,000	240	0.007	0.018	24,750	120	0.007	0.018
"	2	33,000	466	0.010	0.025	33,000	240	0.007	0.018	24,750	120	0.007	0.018
"	3	31,000	352	0.007	0.018	31,405	184	0.005	0.013	23,540	60	0.005	0.013
"	4	27,150	132	0.003	0.008	28,215	80	0.002	0.005	21,890	40	0.002	0.005
"	5	24,200	97	0.002	0.005	25,850	60	0.002	0.005	19,360	28	0.002	0.005
"	6	21,300	66	0.001	0.003	23,430	40	0.001	0.003	17,600	20	0.001	0.003
"	8	15,900	35	0.001	0.003	17,490	20	0.001	0.003	13,145	10	0.001	0.003
R 0.3	1	30,000	1,320	0.030	0.075	29,150	800	0.015	0.038	22,000	400	0.015	0.038
"	2	30,000	1,056	0.020	0.050	29,150	640	0.010	0.025	22,000	320	0.010	0.025
"	3	30,000	704	0.015	0.038	29,150	416	0.008	0.020	22,000	208	0.008	0.020
"	4	30,000	440	0.010	0.025	29,150	272	0.006	0.015	22,000	136	0.006	0.015
"	5	25,000	343	0.007	0.018	25,300	208	0.005	0.013	19,800	104	0.005	0.013
"	6	21,000	282	0.005	0.013	21,450	168	0.004	0.010	16,500	84	0.004	0.010
"	8	16,000	211	0.003	0.008	17,600	128	0.003	0.008	13,200	64	0.003	0.008
"	10	14,900	154	0.002	0.005	16,390	92	0.002	0.005	12,210	44	0.002	0.005
"	12	13,800	97	0.001	0.003	15,180	56	0.001	0.003	11,385	28	0.001	0.003
R 0.4	2	27,000	1,408	0.040	0.100	25,850	800	0.020	0.050	19,250	400	0.020	0.050
"	4	27,000	1,056	0.025	0.063	25,850	480	0.012	0.030	19,250	240	0.012	0.030
"	6	23,000	528	0.012	0.030	22,550	320	0.006	0.015	17,050	160	0.006	0.015
"	8	18,000	330	0.007	0.018	18,700	228	0.005	0.013	14,025	112	0.005	0.013
"	10	14,700	299	0.005	0.013	16,115	180	0.004	0.010	12,100	88	0.004	0.010
R 0.5	2	24,000	1,760	0.100	0.250	23,100	1,400	0.050	0.125	17,600	700	0.050	0.125
"	3	24,000	1,760	0.050	0.125	23,100	1,400	0.030	0.075	17,600	700	0.030	0.075
"	4	24,000	1,760	0.050	0.125	23,100	1,400	0.030	0.075	17,600	700	0.030	0.075
"	5	24,000	1,760	0.050	0.125	23,100	1,400	0.030	0.075	17,600	700	0.030	0.075
"	6	21,500	1,100	0.030	0.075	21,670	840	0.025	0.063	15,950	420	0.025	0.063
"	8	18,500	510	0.015	0.038	20,240	384	0.015	0.038	15,180	192	0.015	0.038
"	10	14,800	378	0.010	0.025	16,170	288	0.010	0.025	12,210	144	0.010	0.025
"	12	13,400	334	0.008	0.020	14,630	232	0.008	0.020	10,945	112	0.008	0.020
"	14	12,000	308	0.007	0.018	13,200	176	0.007	0.018	9,900	88	0.007	0.018
"	16	10,500	220	0.005	0.013	11,550	128	0.005	0.013	8,635	64	0.005	0.013
"	18	9,750	176	0.004	0.010	10,725	104	0.004	0.010	8,030	68	0.004	0.010
"	20	9,000	132	0.003	0.008	9,900	80	0.003	0.008	7,425	40	0.003	0.008
"	22	9,000	97	0.002	0.005	9,900	60	0.002	0.005	7,425	28	0.002	0.005
R 0.6	6	20,000	1,760	0.060	0.150	19,250	1,400	0.036	0.090	14,410	700	0.036	0.090
"	8	16,600	792	0.025	0.063	17,435	600	0.025	0.063	13,090	300	0.025	0.063
"	10	15,500	510	0.015	0.038	16,885	384	0.015	0.038	12,650	192	0.015	0.038
R 0.7	8	15,350	1,100	0.040	0.100	15,455	840	0.030	0.075	11,605	420	0.030	0.075
R 0.75	3	17,000	1,760	0.120	0.300	16,500	1,400	0.060	0.150	12,375	700	0.060	0.150
"	4	17,000	1,760	0.120	0.300	16,500	1,400	0.060	0.150	12,375	700	0.060	0.150
"	6	17,000	1,760	0.070	0.175	16,500	1,400	0.040	0.100	12,375	700	0.040	0.100
"	8	15,000	1,100	0.045	0.113	15,400	840	0.030	0.075	11,550	420	0.030	0.075
"	10	15,000	1,100	0.045	0.113	15,400	840	0.030	0.075	11,550	420	0.030	0.075
"	12	13,000	510	0.020	0.050	14,300	384	0.020	0.050	10,725	192	0.020	0.050
"	14	10,900	427	0.015	0.038	11,990	308	0.015	0.038	9,020	152	0.015	0.038
"	16	8,850	343	0.012	0.030	9,680	232	0.012	0.030	7,260	116	0.012	0.030
"	20	8,000	308	0.010	0.025	8,800	176	0.010	0.025	6,600	88	0.010	0.025
R 0.8	8	17,500	1,848	0.080	0.200	16,830	1,440	0.050	0.125	12,650	720	0.050	0.125
"	12	13,500	528	0.024	0.060	14,740	392	0.024	0.060	11,055	196	0.025	0.063
"	16	10,800	396	0.016	0.040	11,770	296	0.016	0.040	8,800	148	0.016	0.040
R 1	4	14,000	1,848	0.150	0.375	13,475	1,440	0.080	0.200	10,120	720	0.080	0.200
"	6	14,000	1,848	0.100	0.250	13,475	1,440	0.060	0.150	10,120	720	0.060	0.150
"	8	14,000	1,848	0.100	0.250	13,475	1,440	0.060	0.150	10,120	720	0.060	0.150
"	10	14,000	1,848	0.100	0.250	13,475	1,440	0.060	0.150	10,120	720	0.060	1.500
"	12	12,400	1,188	0.060	0.150	12,650	880	0.045	0.113	9,515	440	0.045	0.113
"	14	12,400	1,188	0.060	0.150	12,650	880	0.045	0.113	9,515	440	0.045	0.113

피삭재 Material		고경도강 Hardened Steels STAVX / SKD11				열처리 / 고경도강 Heat-treated steels / Hardened Steels SKD11 / SKD61				열처리 / 고경도강 Heat-treated steels / Hardened Steels YXR7 / SKH51			
경도 Hardness		45 ~ 55HRC				55 ~ 62HRC				62 ~ 70HRC			
반경 Radius	유효장 Effective Length	RPM	FEED	Ap Axial Depth	Ae Radial Depth	RPM	FEED	Ap Axial Depth	Ae Radial Depth	RPM	FEED	Ap Axial Depth	Ae Radial Depth
"	16	10,800	528	0.030	0.075	11,770	392	0.030	0.075	8,800	196	0.030	0.075
"	18	9,700	458	0.025	0.063	10,615	344	0.025	0.063	7,975	172	0.025	0.063
"	20	8,650	396	0.020	0.050	9,416	296	0.020	0.050	7,040	148	0.020	0.050
"	22	8,200	387	0.018	0.045	9,020	264	0.018	0.045	6,765	132	0.018	0.045
"	25	7,800	387	0.016	0.040	8,580	232	0.016	0.040	6,435	116	0.016	0.040
"	30	7,000	308	0.014	0.035	7,700	176	0.014	0.035	5,775	88	0.014	0.035
R 1.25	20	9,600	554	0.040	0.100	10,560	408	0.040	0.100	7,920	204	0.040	0.100
R 1.5	6	10,500	1,936	0.200	0.500	10,120	1,520	0.120	0.300	7,590	760	0.120	0.300
"	8	10,500	1,936	0.200	0.500	10,120	1,520	0.120	0.300	7,590	760	0.120	0.300
"	10	10,500	1,936	0.150	0.375	10,120	1,520	0.100	0.250	7,590	760	0.100	0.250
"	12	10,500	1,936	0.150	0.375	10,120	1,520	0.100	0.250	7,590	760	0.100	0.250
"	16	10,500	1,936	0.150	0.375	10,120	1,520	0.100	0.250	7,590	760	0.100	0.250
"	20	9,250	1,232	0.100	0.250	9,460	920	0.075	0.188	7,095	460	0.075	0.188
"	25	8,000	554	0.050	0.125	8,800	408	0.050	0.125	6,600	204	0.050	0.125
"	30	5,750	396	0.030	0.075	6,270	296	0.030	0.075	4,703	148	0.030	0.075
"	35	5,350	387	0.025	0.063	5,885	248	0.025	0.063	4,400	124	0.025	0.063
"	40	4,900	343	0.020	0.050	5,445	200	0.020	0.050	4,070	100	0.020	0.050
R 2	8	9,000	2,024	0.250	0.625	8,690	1,600	0.150	0.375	6,490	800	0.150	0.375
"	10	9,000	2,024	0.250	0.625	8,690	1,600	0.150	0.375	6,490	800	0.150	0.375
"	12	9,000	2,024	0.200	0.500	8,690	1,600	0.130	0.325	6,490	800	0.130	0.325
"	16	9,000	2,024	0.200	0.500	8,690	1,600	0.130	0.325	6,490	800	0.130	0.325
"	20	9,000	2,024	0.200	0.500	8,690	1,600	0.130	0.325	6,490	800	0.130	0.325
"	25	8,000	1,276	0.130	0.325	8,195	1,000	0.090	0.225	6,160	500	0.090	0.225
"	30	7,000	581	0.060	0.150	7,700	432	0.060	0.150	5,775	216	0.060	0.150
"	35	6,000	554	0.055	0.138	6,600	408	0.055	0.138	4,950	204	0.055	0.138
"	40	4,300	396	0.040	0.100	4,730	296	0.040	0.100	3,520	148	0.040	0.100
R 2.5	20	7,200	2,024	0.250	0.625	6,985	1,600	0.160	0.400	5,225	800	0.160	0.400
"	30	6,400	1,276	0.160	0.400	6,820	1,000	0.110	0.275	5,115	500	0.110	0.275
"	40	6,000	607	0.080	0.200	6,600	456	0.080	0.200	4,950	228	0.080	0.200
R 3	15	6,500	2,200	0.300	0.750	6,270	1,760	0.200	0.500	4,730	880	0.200	0.500
R 4	25	5,200	1,936	0.400	1.000	4,950	1,520	0.250	0.625	3,740	760	0.250	0.625
R 5	30	4,300	1,760	0.500	1.250	4,125	1,400	0.300	0.750	3,080	700	0.300	0.750
R 6	30	3,600	1,540	0.600	1.500	3,465	1,200	0.350	0.875	2,585	600	0.350	0.875

**절입량**  
Depth of Cut

Ap : Axial Depth 축방향의절입깊이(mm)  
 Ae : Radial Depth 반경방향의절입깊이(mm)  
 D : Outside Diameter 외경(mm)  
 n : Speed 회전속도 (min<sup>-1</sup>)  
 Vf : Feed 이송속도 (mm/min)

- HRC55 이하 피삭재(합금강, 공구강) 가공시 같은 파이에 대비 상기절삭조건 20% UP 해주십시오.
- 에어브로 혹은 미스트 쿨런트를 추천하며, 동 가공시 습식 쿨런트 추천 합니다.
- 상기 절삭조건은 참고 수치이므로 실 가공시 가공 형상, 가공 목적, 적용 기계에 따라 변경 요망합니다.
- 진동이 적고 강성이 좋은 공작 기계 사용 요망 합니다(Ø1 이하 사용 시 진동 허용 관리 5µm 이내일 것.)
- 칩 제거 주의 및 가공시 발열, 발화에 주의하십시오.
- When milling workpiece HRC below 55 (Alloy steel, tool steel), Raise up 20% RPM and feed compared to the same diameter.
- Air blow or mist coolant is recommended, and wet coolants are recommended for copper milling.
- Use this table for your reference. Adjust the parameters depending on your machining geometry, machining purpose and CNC.
- Use a machine with low vibration and good rigidity (Ø1 or less, the vibration tolerance management will be within 5µm).
- Note for chip emission, heat, or ignition.

피삭재 Material		고경도강 Hardened Steels STAVX / SKD11				열처리 / 고경도강 Heat-treated steels / Hardened Steels SKD11 / SKD61				열처리 / 고경도강 Heat-treated steels / Hardened Steels YXR7 / SKH51			
경도 Hardness		45 ~ 55HRC				55 ~ 62HRC				62 ~ 70HRC			
반경 Radius	유효장 Effective Length	RPM	FEED	Ap Axial Depth	Ae Radial Depth	RPM	FEED	Ap Axial Depth	Ae Radial Depth	RPM	FEED	Ap Axial Depth	Ae Radial Depth
R 0.5	4	25,500	2,360	0.050	0.200	21,000	2,000	0.030	0.170	16,000	960	0.030	0.170
"	8	18,500	760	0.015	0.120	18,400	710	0.015	0.120	13,800	287	0.015	0.120
"	12	13,400	540	0.008	0.080	13,300	405	0.008	0.080	9,950	189	0.008	0.080
"	16	10,500	320	0.005	0.045	10,500	225	0.005	0.045	7,850	115	0.005	0.045
R 0.75	8	15,000	1,389	0.045	0.250	14,000	1,280	0.030	0.210	10,500	648	0.030	0.210
"	16	8,850	530	0.012	0.130	8,800	489	0.012	0.130	6,600	208	0.012	0.130
R 1	8	14,000	2,350	0.100	0.400	12,250	1,960	0.060	0.300	9,200	1,060	0.060	0.300
"	16	10,800	776	0.030	0.240	10,700	580	0.030	0.240	8,000	335	0.030	0.240
"	25	7,800	530	0.016	0.160	7,800	380	0.016	0.160	5,850	320	0.016	0.160
R 1.5	16	10,500	2,500	0.150	0.650	9,200	2,100	0.100	0.500	6,900	1,100	0.100	0.500
"	25	8,000	820	0.050	0.380	8,000	640	0.050	0.380	6,000	355	0.050	0.380
"	40	4,900	530	0.020	0.240	4,950	360	0.020	0.240	3,700	220	0.020	0.240
R 2	20	9,000	2,680	0.200	0.850	7,900	2,250	0.130	0.700	5,900	1,240	0.130	0.700
"	30	7,000	845	0.060	0.450	7,000	710	0.060	0.450	5,250	374	0.060	0.450
"	40	4,300	640	0.040	0.390	4,300	420	0.040	0.390	3,200	267	0.040	0.390
R 2.5	30	6,400	1,630	0.160	0.880	6,200	1,430	0.110	0.730	4,650	775	0.110	0.730
"	40	6,000	820	0.080	0.625	5,900	760	0.080	0.625	4,500	415	0.080	0.625
"	50	5,300	530	0.050	0.410	5,200	490	0.040	0.400	4,300	295	0.035	0.370
R 3	20	6,500	2,820	0.300	1.300	5,700	2,390	0.200	1.000	4,300	1,360	0.200	1.000
"	30	6,400	1,720	0.160	0.880	6,200	1,538	0.110	0.730	4,650	843	0.110	0.730
R 4	25	5,200	2,350	0.400	1.700	4,500	2,100	0.250	1.350	3,400	1,060	0.250	1.350
"	40	3,600	1,570	0.300	0.850	2,700	1,260	0.150	0.720	2,040	636	0.120	0.700
R 5	30	4,300	2,170	0.500	2.100	3,750	1,860	0.300	1.700	2,800	986	0.300	1.700
"	50	3,400	1,330	0.400	1.050	2,419	1,200	0.200	0.750	1,806	636	0.190	0.680
R 6	35	3,600	1,890	0.600	2.600	3,150	1,680	0.350	2.000	2,350	840	0.350	2.000
"	60	2,700	1,180	0.500	1.300	1,956	1,043	0.250	0.900	1,459	522	0.220	0.850

절입량  
Depth of Cut

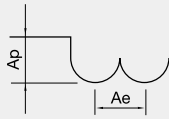

Ap : Axial Depth 축방향의절입깊이(mm)  
 Ae : Radial Depth 반경방향의절입깊이(mm)  
 D : Outside Diameter 외경(mm)  
 n : Speed 회전속도 (min<sup>-1</sup>)  
 Vf : Feed 이송속도 (mm/min)

- HRC55 이하 피삭재(합금강, 공구강) 가공시 같은 파이에 대비 상기 절삭조건 20% UP 해주십시오.
- 에어브로 혹은 미스트쿨러를 추천하며, 동 가공시 습식쿨러 추천 합니다.
- 상기 절삭조건은 참고 수치이므로 실 가공시 가공 형상, 가공 목적, 적용 기계에 따라 조건 변경 요망합니다.
- 진동이 적고 강성이 좋은 공작 기계 사용 요망 합니다.(Ø1 이하 사용 시 진동 허용 관리 5µm 이내일 것.)
- 칩 제거 주의 및 가공시 발열, 발화에 주의하십시오.
- When milling workpiece HRC below 55 (Alloy steel, tool steel), Raise up 20% RPM and feed compared to the same diameter.
- Air blow or mist coolant is recommended, and wet coolants are recommended for copper milling.
- Use this table for your reference. Adjust the parameters depending on your machining geometry, machining purpose and CNC.
- Use a machine with low vibration and good rigidity (Ø1 or less, the vibration tolerance management will be within 5µm).
- Note for chip emission, heat, or ignition.

피삭재 Material			합금강 / 프리하드강 Alloy Steels / Pre-hardened Steels NAK80 / KP4M			고경도강 Hardened Steels STAVAX / SKD11			열처리 / 고경도강 Heat-treated steels / Hardened Steels SKD11 / SKD61			열처리 / 고경도강 Heat-treated steels / Hardened Steels YXR7 / SKH51		
경도 Hardness			40 ~ 45HRc			45 ~ 55HRc			55 ~ 62HRc			62 ~ 70HRc		
반경 Radius	유효장 Effective Length	각도 Taper Angle	RPM	FEED	Ap Axial Depth	RPM	FEED	Ap Axial Depth	RPM	FEED	Ap Axial Depth	RPM	FEED	Ap Axial Depth
R0.1	1.5	0° 30	42,000	630	0.007	28,350	431	0.005	27,300	326	0.005	27,300	252	0.004
"	2	0° 30	32,550	368	0.005	22,575	252	0.004	21,000	200	0.003	21,000	179	0.003
"	1.5	1°	42,000	630	0.007	28,350	431	0.005	27,300	326	0.005	27,300	252	0.004
"	2	1°	32,550	368	0.005	22,575	252	0.004	21,000	200	0.003	21,000	179	0.003
"	2.5	1°	28,000	230	0.002	19,500	180	0.001	17,000	155	0.001	17,000	155	0.001
"	1.5	1° 30	42,000	630	0.007	28,350	431	0.005	27,300	326	0.005	27,300	252	0.004
"	2	1° 30	32,550	368	0.005	22,575	252	0.004	21,000	200	0.003	21,000	179	0.003
"	2.5	1° 30	28,000	230	0.003	19,500	180	0.001	17,000	155	0.001	17,000	155	0.001
"	1.5	2°	42,000	630	0.007	28,350	431	0.005	27,300	326	0.005	27,300	252	0.004
"	2	2°	32,550	368	0.005	22,575	252	0.004	21,000	200	0.003	21,000	179	0.003
"	2.5	2°	28,000	230	0.004	19,500	180	0.002	17,000	155	0.001	17,000	155	0.001
"	1.5	3°	42,000	630	0.007	28,350	431	0.005	27,300	326	0.005	27,300	252	0.004
"	2	3°	32,550	368	0.005	22,575	252	0.004	21,000	200	0.003	21,000	179	0.003
"	2.5	3°	28,000	230	0.004	19,500	180	0.002	17,000	155	0.001	17,000	155	0.001
R0.15	3	0° 30	34,650	641	0.008	23,310	399	0.006	21,525	336	0.005	21,525	294	0.004
"	2	1°	34,650	641	0.008	23,310	399	0.006	21,525	336	0.005	21,525	294	0.004
"	3	1°	34,650	641	0.008	23,310	399	0.006	21,525	336	0.005	21,525	294	0.004
"	4	1°	32,550	494	0.005	22,050	326	0.004	19,950	242	0.003	19,950	189	0.001
"	5	1°	32,550	494	0.003	22,050	326	0.002	19,950	242	0.002	19,950	189	0.001
"	2	1° 30	34,650	641	0.008	23,310	399	0.006	21,525	336	0.005	21,525	294	0.004
"	3	1° 30	34,650	641	0.008	23,310	399	0.006	21,525	336	0.005	21,525	294	0.004
"	4	1° 30	32,550	494	0.003	22,050	326	0.002	19,950	242	0.002	19,950	189	0.002
"	5	1° 30	32,550	494	0.003	22,050	326	0.002	19,950	242	0.002	19,950	189	0.002
"	2	2°	34,650	641	0.008	23,310	399	0.006	21,525	336	0.005	21,525	294	0.004
"	3	2°	34,650	641	0.008	23,310	399	0.006	21,525	336	0.005	21,525	294	0.004
"	4	2°	32,550	494	0.003	22,050	326	0.002	19,950	242	0.002	19,950	189	0.002
"	5	2°	32,550	494	0.003	22,050	326	0.002	19,950	242	0.002	19,950	189	0.002
"	2	3°	34,650	641	0.008	23,310	399	0.006	21,525	336	0.005	21,525	294	0.004
"	3	3°	34,650	641	0.008	23,310	399	0.006	21,525	336	0.005	21,525	294	0.004
"	4	3°	32,550	494	0.004	22,050	326	0.003	19,950	242	0.002	19,950	189	0.003
"	5	3°	32,550	494	0.004	22,050	326	0.003	19,950	242	0.002	19,950	189	0.003
R0.2	2	0° 30	32,000	1,155	0.016	28,350	788	0.013	26,250	672	0.011	26,250	473	0.008
"	3	0° 30	30,000	950	0.016	26,300	650	0.013	23,800	580	0.011	23,800	395	0.008
"	4	0° 30	28,000	780	0.010	21,000	500	0.008	19,000	475	0.007	19,000	325	0.005
"	5	0° 30	25,200	525	0.004	17,850	326	0.003	16,800	294	0.003	16,800	252	0.002
"	6	0° 30	25,200	525	0.004	17,850	326	0.003	16,800	294	0.003	16,800	252	0.002
"	2	1°	32,000	1,155	0.016	28,350	788	0.013	26,250	672	0.011	26,250	473	0.008
"	3	1°	30,000	950	0.016	26,300	650	0.013	23,800	580	0.011	23,800	395	0.008
"	4	1°	28,000	780	0.010	21,000	500	0.008	19,000	475	0.007	19,000	325	0.005
"	5	1°	25,200	525	0.004	17,850	326	0.003	16,800	294	0.003	16,800	252	0.002
"	6	1°	25,200	525	0.004	17,850	326	0.003	16,800	294	0.003	16,800	252	0.002
"	2	2°	32,000	1,155	0.016	28,350	788	0.013	26,250	672	0.011	26,250	473	0.008
"	3	2°	30,000	950	0.016	26,300	650	0.013	23,800	580	0.011	23,800	395	0.008
"	4	2°	28,000	780	0.010	21,000	500	0.008	19,000	475	0.007	19,000	325	0.005
"	5	2°	25,200	525	0.004	17,850	326	0.003	16,800	294	0.003	16,800	252	0.002
"	6	2°	25,200	525	0.004	17,850	326	0.003	16,800	294	0.003	16,800	252	0.002
R0.25	4	0° 30	34,650	1,187	0.019	28,350	861	0.015	24,675	630	0.013	24,675	609	0.011
"	6	0° 30	21,525	609	0.006	17,850	431	0.005	15,750	368	0.004	15,750	326	0.003
"	4	1°	34,650	1,187	0.019	28,350	861	0.015	24,675	630	0.013	24,675	609	0.011
"	6	1°	21,525	609	0.006	17,850	431	0.005	15,750	368	0.004	15,750	326	0.003
"	8	1°	21,525	609	0.005	17,850	431	0.004	15,750	368	0.003	15,750	326	0.003
"	10	1°	21,525	609	0.004	17,850	431	0.003	15,750	368	0.003	15,750	326	0.003
"	4	1° 30	34,650	1,187	0.019	28,350	861	0.015	24,675	630	0.013	24,675	609	0.011
"	6	1° 30	21,525	609	0.008	17,850	431	0.005	15,750	368	0.006	15,750	326	0.005
"	8	1° 30	21,525	609	0.007	17,850	431	0.005	15,750	368	0.005	15,750	326	0.004
"	10	1° 30	21,525	609	0.006	17,850	431	0.005	15,750	368	0.004	15,750	326	0.003
"	4	2°	34,650	1,187	0.019	28,350	861	0.015	24,675	630	0.013	24,675	609	0.011
"	6	2°	21,525	609	0.006	17,850	431	0.005	15,750	368	0.004	15,750	326	0.003
"	8	2°	21,525	609	0.006	17,850	431	0.005	15,750	368	0.004	15,750	326	0.003
"	10	2°	21,525	609	0.006	17,850	431	0.005	15,750	368	0.004	15,750	326	0.003
R0.3	4	0° 30	43,050	2,142	0.032	31,500	1,418	0.022	23,625	788	0.021	23,625	704	0.016
"	8	0° 30	26,775	998	0.016	22,050	735	0.013	16,800	515	0.011	16,800	410	0.008
"	12	0° 30	26,250	893	0.008	22,575	714	0.006	14,700	399	0.005	13,650	336	0.004
"	4	1°	43,050	2,142	0.032	31,500	1,418	0.022	23,625	788	0.021	23,625	704	0.016
"	8	1°	26,775	998	0.020	22,050	735	0.015	16,800	515	0.013	16,800	410	0.009
"	12	1°	26,250	893	0.010	22,575	714	0.012	14,700	399	0.008	13,650	336	0.005

# 2JTB Cutting Condition

• RPM : rev./min • Feed : mm/min

피삭재 Material			합금강 / 프리하드강 Alloy Steels / Pre-hardened Steels NAK80 / KP4M			고경도강 Hardened Steels STAVAX / SKD11			열처리 / 고경도강 Heat-treated steels / Hardened Steels SKD11 / SKD61			열처리 / 고경도강 Heat-treated steels / Hardened Steels YXR7 / SKH51		
경도 Hardness			40 ~ 45Hrc			45 ~ 55Hrc			55 ~ 62Hrc			62 ~ 70Hrc		
반경 Radius	유효장 Effective Length	각도 Taper Angle	RPM	FEED	Ap Axial Depth	RPM	FEED	Ap Axial Depth	RPM	FEED	Ap Axial Depth	RPM	FEED	Ap Axial Depth
R 0.3	4	1° 30'	43,050	2,142	0.032	31,500	1,418	0.022	23,625	788	0.021	23,625	704	0.016
"	8	1° 30'	26,775	998	0.020	22,050	735	0.015	16,800	515	0.015	16,800	410	0.010
"	12	1° 30'	26,250	893	0.010	22,575	714	0.012	14,700	399	0.010	13,650	336	0.007
"	4	2°	43,050	2,142	0.032	31,500	1,418	0.022	23,625	788	0.021	23,625	704	0.016
"	8	2°	26,775	998	0.022	22,050	735	0.017	16,800	515	0.016	16,800	410	0.010
"	12	2°	26,250	893	0.012	22,575	714	0.014	14,700	399	0.012	13,650	336	0.007
R 0.4	4	0° 30'	43,050	2,310	0.037	29,400	1,470	0.028	24,150	861	0.026	24,150	714	0.016
"	8	0° 30'	26,775	1,365	0.021	18,900	945	0.016	15,750	630	0.016	15,750	578	0.011
"	12	0° 30'	26,775	1,050	0.016	16,275	525	0.013	12,600	462	0.011	12,600	420	0.007
"	4	1°	43,050	2,310	0.037	29,400	1,470	0.028	24,150	861	0.026	24,150	714	0.016
"	8	1°	26,775	1,365	0.021	18,900	945	0.016	15,750	630	0.016	15,750	578	0.011
"	12	1°	26,775	1,050	0.016	16,275	525	0.013	12,600	462	0.011	12,600	420	0.007
"	4	1° 30'	43,050	2,310	0.037	29,400	1,470	0.028	24,150	861	0.026	24,150	714	0.016
"	8	1° 30'	26,775	1,365	0.021	18,900	945	0.016	15,750	630	0.016	15,750	578	0.011
"	12	1° 30'	26,775	1,050	0.016	16,275	525	0.013	12,600	462	0.011	12,600	420	0.007
"	4	2°	43,050	2,310	0.037	29,400	1,470	0.028	24,150	861	0.026	24,150	714	0.016
"	8	2°	26,775	1,365	0.021	18,900	945	0.016	15,750	630	0.016	15,750	578	0.011
"	12	2°	26,775	1,050	0.016	16,275	525	0.013	12,600	462	0.011	12,600	420	0.007

# 2JTB/3JTB Cutting Condition

• RPM : rev./min • Feed : mm/min

피삭재 Material			합금강 / 프리하드강 Alloy Steels / Pre-hardened Steels NAK80 / KPM4M			고경도강 Hardened Steels STAVAX / SKD11			열처리 / 고경도강 Heat-treated steels / Hardened Steels SKD11 / SKD61			열처리 / 고경도강 Heat-treated steels / Hardened Steels YXR7 / SKH51		
경도 Hardness			40 ~ 45Hrc			45 ~ 55Hrc			55 ~ 62Hrc			62 ~ 70Hrc		
반경 Radius	유효장 Effective Length	각도 Taper Angle	RPM	FEED	Ap Axial Depth	RPM	FEED	Ap Axial Depth	RPM	FEED	Ap Axial Depth	RPM	FEED	Ap Axial Depth
R 0.5	6	0° 30'	26,250	2,100	0.047	17,850	1,365	0.037	17,850	1,050	0.032	16,800	861	0.026
"	10	0° 30'	17,850	1,103	0.023	12,600	767	0.019	11,550	683	0.017	11,550	525	0.013
"	20	0° 30'	15,750	945	0.014	10,500	683	0.011	9,450	567	0.008	9,450	462	0.008
"	6	1°	26,250	2,100	0.047	17,850	1,365	0.037	17,850	1,050	0.032	16,800	861	0.026
"	10	1°	17,850	1,103	0.023	12,600	767	0.019	11,550	683	0.017	11,550	525	0.013
"	20	1°	15,750	945	0.014	10,500	683	0.011	9,450	567	0.008	9,450	462	0.008
"	30	1°	15,750	750	0.007	10,500	540	0.005	9,450	430	0.004	9,450	360	0.004
"	6	1° 30'	26,250	2,100	0.047	17,850	1,365	0.037	17,850	1,050	0.032	16,800	861	0.026
"	10	1° 30'	17,850	1,103	0.023	12,600	767	0.019	11,550	683	0.017	11,550	525	0.013
"	20	1° 30'	15,750	945	0.014	10,500	683	0.011	9,450	567	0.008	9,450	462	0.008
"	30	1° 30'	15,750	750	0.007	10,500	540	0.005	9,450	430	0.004	9,450	360	0.004
"	20	2°	15,750	945	0.014	10,500	683	0.011	9,450	567	0.008	9,450	462	0.008
"	30	2°	15,750	750	0.007	10,500	540	0.005	9,450	430	0.004	9,450	360	0.004
"	20	3°	15,750	945	0.014	10,500	683	0.011	9,450	567	0.008	9,450	462	0.008
"	30	3°	15,750	750	0.007	10,500	540	0.005	9,450	430	0.004	9,450	360	0.004
"	40	3°	12,250	550	0.004	8,550	420	0.002	7,800	365	0.002	7,800	285	0.002
R 0.75	10	0° 30'	18,900	2,205	0.063	12,600	1,470	0.042	12,600	1,155	0.037	12,600	893	0.032
"	20	0° 30'	13,650	1,260	0.032	9,450	945	0.021	9,450	735	0.016	9,450	630	0.014
"	30	0° 30'	9,450	893	0.016	7,350	651	0.013	7,350	546	0.011	7,350	504	0.011
"	10	1°	18,900	2,205	0.063	12,600	1,470	0.042	12,600	1,155	0.037	12,600	893	0.032
"	20	1°	13,650	1,260	0.032	9,450	945	0.021	9,450	735	0.016	9,450	630	0.014
"	30	1°	9,450	893	0.016	7,350	651	0.013	7,350	546	0.011	7,350	504	0.011
"	10	1° 30'	18,900	2,205	0.063	12,600	1,470	0.042	12,600	1,155	0.037	12,600	893	0.032
"	20	1° 30'	13,650	1,260	0.036	9,450	945	0.024	9,450	735	0.018	9,450	630	0.016
"	30	1° 30'	9,450	893	0.017	7,350	651	0.014	7,350	546	0.012	7,350	504	0.011
"	40	1° 30'	8,400	675	0.010	6,300	510	0.008	6,300	420	0.007	6,300	400	0.006
"	10	2°	18,900	2,205	0.063	12,600	1,470	0.042	12,600	1,155	0.037	12,600	893	0.032
"	20	2°	13,650	1,260	0.036	9,450	945	0.024	9,450	735	0.018	9,450	630	0.016
"	30	2°	9,450	893	0.017	7,350	651	0.014	7,350	546	0.012	7,350	504	0.011
"	40	2°	8,400	675	0.010	6,300	510	0.008	6,300	420	0.007	6,300	400	0.006
R 1	12	0° 30'	15,750	2,468	0.084	11,550	1,785	0.068	11,025	1,428	0.059	11,025	1,124	0.048
"	20	0° 30'	10,500	1,470	0.063	8,400	1,050	0.053	9,450	1,050	0.047	9,450	924	0.037
"	30	0° 30'	9,450	1,260	0.047	7,350	840	0.037	7,350	819	0.032	7,350	672	0.026
"	40	0° 30'	9,450	1,260	0.037	7,035	819	0.032	6,300	735	0.026	6,300	609	0.021
"	12	1°	15,750	2,468	0.084	11,550	1,785	0.068	11,025	1,428	0.059	11,025	1,124	0.048
"	20	1°	10,500	1,470	0.063	8,400	1,050	0.053	9,450	1,050	0.047	9,450	924	0.037



피삭재 Material			합금강 / 프리하드강 Alloy Steels / Pre-hardened Steels NAK80 / KP4M			고경도강 Hardened Steels STAVAX / SKD11			열처리 / 고경도강 Heat-treated steels / Hardened Steels SKD11 / SKD61			열처리 / 고경도강 Heat-treated steels / Hardened Steels YXR7 / SKH51		
경도 Hardness			40 ~ 45HRc			45 ~ 55HRc			55 ~ 62HRc			62 ~ 70HRc		
반경 Radius	유효장 Effective Length	각도 Taper Angle	RPM	FEED	Ap Axial Depth	RPM	FEED	Ap Axial Depth	RPM	FEED	Ap Axial Depth	RPM	FEED	Ap Axial Depth
R 1	30	1°	9,450	1,260	0.047	7,350	840	0.037	7,350	819	0.032	7,350	672	0.026
"	40	1°	9,450	1,260	0.037	7,035	819	0.032	6,300	735	0.026	6,300	609	0.021
"	50	1°	7,900	990	0.027	6,650	770	0.025	5,600	655	0.022	5,600	525	0.015
"	12	1° 30'	15,750	2,468	0.090	11,550	1,785	0.068	11,025	1,428	0.065	11,025	1,124	0.052
"	20	1° 30'	10,500	1,470	0.074	8,400	1,050	0.060	9,450	1,050	0.054	9,450	924	0.042
"	30	1° 30'	9,450	1,260	0.055	7,350	840	0.043	7,350	819	0.038	7,350	672	0.031
"	40	1° 30'	9,450	1,260	0.043	7,035	819	0.037	6,300	735	0.033	6,300	609	0.026
"	50	1° 30'	7,900	990	0.030	6,650	770	0.028	5,600	655	0.029	5,600	525	0.021
"	30	2°	9,450	1,260	0.055	7,350	840	0.043	7,350	819	0.038	7,350	672	0.031
"	40	2°	9,450	1,260	0.043	7,035	819	0.037	6,300	735	0.033	6,300	609	0.026
"	50	2°	7,900	990	0.030	6,650	770	0.028	5,600	655	0.029	5,600	525	0.021
"	30	3°	9,450	1,260	0.055	7,350	840	0.043	7,350	819	0.038	7,350	672	0.031
"	40	3°	9,450	1,260	0.043	7,035	819	0.037	6,300	735	0.033	6,300	609	0.026
"	50	3°	7,900	990	0.030	6,650	770	0.028	5,600	655	0.029	5,600	525	0.021
R 1.5	20	0° 30'	10,500	2,310	0.095	8,400	1,365	0.074	7,350	1,260	0.063	7,350	1,155	0.053
"	30	0° 30'	9,450	1,890	0.079	7,350	1,103	0.063	6,300	1,050	0.053	6,300	924	0.044
"	40	0° 30'	7,875	1,470	0.063	5,250	924	0.053	5,355	840	0.042	5,355	735	0.037
"	50	0° 30'	7,875	1,365	0.042	5,250	840	0.032	5,355	788	0.026	5,355	683	0.024
"	20	1°	10,500	2,310	0.095	8,400	1,365	0.074	7,350	1,260	0.063	7,350	1,155	0.053
"	30	1°	9,450	1,890	0.079	7,350	1,103	0.063	6,300	1,050	0.053	6,300	924	0.044
"	40	1°	7,875	1,470	0.063	5,250	924	0.053	5,155	840	0.042	5,155	735	0.037
"	50	1°	7,875	1,365	0.042	5,250	840	0.032	5,155	788	0.026	5,155	683	0.024
"	60	1°	6,400	1,225	0.028	4,325	710	0.021	4,300	670	0.018	4,300	540	0.016
"	20	1° 30'	10,500	2,310	0.095	8,400	1,365	0.074	7,350	1,260	0.063	7,350	1,155	0.053
"	30	1° 30'	9,450	1,890	0.079	7,350	1,103	0.063	6,300	1,050	0.053	6,300	924	0.044
"	40	1° 30'	7,875	1,470	0.063	5,250	924	0.053	5,355	840	0.042	5,355	735	0.037
"	50	1° 30'	7,875	1,365	0.042	5,250	840	0.032	5,355	788	0.026	5,355	683	0.024
"	60	1° 30'	6,400	1,225	0.028	4,325	710	0.021	4,300	670	0.018	4,300	540	0.016
"	20	2°	10,500	2,310	0.095	8,400	1,365	0.074	7,350	1,260	0.063	7,350	1,155	0.053
"	30	2°	9,450	1,890	0.079	7,350	1,103	0.063	6,300	1,050	0.053	6,300	924	0.044
"	48	2°	7,875	1,365	0.042	5,250	840	0.032	5,355	788	0.026	5,355	683	0.024
"	60	2°	6,400	1,225	0.028	4,325	710	0.021	4,300	670	0.018	4,300	540	0.016
"	30	3°	9,450	1,890	0.079	7,350	1,103	0.063	6,300	1,050	0.053	6,300	924	0.044
"	50	3°	7,875	1,365	0.042	5,250	840	0.032	5,355	788	0.026	5,355	683	0.024
R 2	40	0° 30'	6,300	1,260	0.085	3,675	630	0.068	3,360	557	0.053	3,360	525	0.045
"	60	0° 30'	4,200	767	0.063	3,150	473	0.047	2,940	420	0.042	2,940	368	0.033
"	50	1°	5,250	1,010	0.074	3,450	550	0.058	3,120	480	0.048	3,110	445	0.038
"	60	1°	4,200	767	0.063	3,150	473	0.047	2,940	420	0.042	2,940	368	0.033
"	70	1°	3,200	540	0.048	2,760	320	0.036	2,770	360	0.036	2,770	300	0.028
"	45	1° 30'	5,250	1,010	0.074	3,450	550	0.058	3,120	480	0.048	3,110	445	0.038
"	60	1° 30'	4,200	767	0.063	3,150	473	0.047	2,940	420	0.042	2,940	368	0.033
"	70	1° 30'	3,200	540	0.048	2,760	320	0.036	2,770	360	0.036	2,770	300	0.028
"	25	3°	9,450	1,890	0.079	7,350	1,103	0.063	6,300	1,050	0.053	6,300	924	0.044
"	42	3°	7,875	1,365	0.042	5,250	840	0.032	5,355	788	0.026	5,355	683	0.024
R 2.5	40	1°	6,300	1,260	0.085	3,675	630	0.068	3,360	557	0.053	3,360	525	0.045
"	60	1°	4,200	767	0.063	3,150	473	0.047	2,940	420	0.042	2,940	368	0.033
"	90	1°	2,200	480	0.041	2,450	280	0.030	2,470	250	0.028	2,200	237	0.023
"	40	1° 30'	6,300	1,260	0.085	3,675	630	0.068	3,360	557	0.053	3,360	525	0.045
"	60	1° 30'	4,200	767	0.063	3,150	473	0.047	2,940	420	0.042	2,940	368	0.033
"	90	1° 30'	2,200	480	0.041	2,450	280	0.030	2,470	250	0.028	2,200	237	0.023
R 3	40	1°	9,450	2,205	0.147	7,350	1,103	0.105	6,300	998	0.084	6,300	893	0.061
"	50	1°	7,800	1,910	0.122	5,980	980	0.088	5,000	845	0.070	5,300	760	0.055
"	60	1°	6,100	1,670	0.105	5,285	820	0.070	4,180	760	0.062	4,300	620	0.048
"	70	1°	4,725	1,470	0.074	4,095	735	0.063	3,570	683	0.053	3,570	578	0.042
"	80	1°	3,540	1,320	0.061	3,400	640	0.046	2,100	510	0.040	2,100	468	0.033
"	49	1° 30'	7,800	1,910	0.122	5,980	980	0.088	5,000	845	0.070	5,300	760	0.055
"	85	1° 30'	3,360	1,220	0.055	3,100	580	0.040	1,880	460	0.035	1,880	448	0.028
"	60	2°	6,100	1,670	0.105	5,285	820	0.070	4,180	760	0.062	4,300	620	0.048
"	90	2°	3,000	1,050	0.055	2,870	520	0.040	1,720	410	0.035	1,720	400	0.028
R 4	50	1°	9,345	2,310	0.189	7,350	1,155	0.147	6,300	1,050	0.105	6,300	840	0.086
"	60	1°	7,150	1,846	0.138	5,330	916	0.114	4,550	820	0.080	4,550	655	0.064
"	80	1°	4,515	1,365	0.095	3,360	683	0.084	3,045	578	0.068	3,045	473	0.042
"	52	1° 30'	9,345	2,310	0.197	7,350	1,155	0.154	6,300	1,050	0.113	6,300	840	0.094
"	89	1° 30'	3,400	1,090	0.073	2,970	578	0.046	1,890	454	0.041	1,860	443	0.033

# 2JJTB/3JJTBS Cutting Condition

• RPM : rev./min • Feed : mm/min

피삭재 Material			합금강 / 프리하든강 Alloy Steels / Pre-hardened Steels NAK80 / KP4M			고경도강 Hardened Steels STAVAX / SKD11			열처리 / 고경도강 Heat-treated steels / Hardened Steels SKD11 / SKD61			열처리 / 고경도강 Heat-treated steels / Hardened Steels YXR7 / SKH51		
경도 Hardness			40 ~ 45Hrc			45 ~ 55Hrc			55 ~ 62Hrc			62 ~ 70Hrc		
반경 Radius	유효장 Effective Length	각도 Taper Angle	RPM	FEED	Ap Axial Depth	RPM	FEED	Ap Axial Depth	RPM	FEED	Ap Axial Depth	RPM	FEED	Ap Axial Depth
R 5	60	1°	5,775	1,785	0.194	3,675	893	0.168	3,570	735	0.126	3,570	630	0.084
"	75	1°	4,200	998	0.093	3,150	504	0.068	2,940	420	0.053	2,940	336	0.034
"	54	1° 30'	6,175	1,850	0.220	3,935	923	0.185	3,760	768	0.146	3,760	678	0.097
R 6	85	1° 30'	2,940	336	0.063	1,995	168	0.032	1,575	158	0.016	1,575	105	0.011
"	63	3°	3,990	735	0.126	2,940	368	0.086	2,625	326	0.063	2,625	231	0.047

절입량  
Depth of Cut

Ap : Axial Depth 축방향의절입깊이(mm)  
 Ae : Radial Depth 반경방향의절입깊이(mm)  
 D : Outside Diameter 외경(mm)  
 n : Speed 회전속도 (min<sup>-1</sup>)  
 Vf : Feed 이송속도 (mm/min)

- 절삭조건에 없는 각도는 같은 직경에 이전 각도와 비례하여 사용하십시오.
- 이송속도 및 축방향의 절입깊이는 리브창과 테이퍼각에 따라 고려하시고, 절삭상황에 맞추어 조정하십시오.
- 에어브로 혹은 미스트 콜러트를 추천하며, 동 가공 시 습식 콜러트 추천합니다.
- 상기 절삭조건은 참고 수치이므로 실 가공시 가공 형상, 가공 목적, 적용 기계에 따라 조건 변경 요망합니다.
- 적용 기계의 회전속도가 부족한 경우에는 회전속도와 이송속도를 같은 비율로 줄여서 적용합니다.
- 칩 제거 주의 및 가공시 발열, 발화에 주의하십시오.

- If there is no same taper angle of your endmill on the table, refer to the previous taper angle of diameter and apply the same proportion.
- Adjust the value of the feed and Ap based on the effective length and taper angle, and adjust the milling condition.
- Air blow or mist coolant is recommended, and wet coolants are recommended for copper milling.
- Use this table for your reference. Adjust the parameters depending on your machining geometry, machining purpose and CNC.
- Where the parameters exceed the machine's maximum spindle speed, the RPM and feedrate should be reduced proportionally.
- Note for chip emission, heat or ignition.

# 2JJSP Cutting Condition

• RPM : rev./min • Feed : mm/min

피삭재 Material	공구강 / 금형강 Tool Steels / Alloy Steels SCM/HPM		합금강 / 프리하든강 Alloy Steels / Prehardened Steels NAK80/KP4M		스테인레스강 Stainless Steels SUS304/SUS316		고경도강 Hardened Steels STAVAX/SKD11		열처리 / 고경도강 Heat-treated steels / Hardened Steels SKD11 / SKD61 / YXR7 / R7 / SKH51		열처리 / 고경도강 Heat-treated steels / Hardened Steels SKD11 / SKD61 / YXR7 / R7 / SKH51	
	경도 Hardness	30 ~ 40Hrc	40 ~ 45Hrc		-		45 ~ 55Hrc		55 ~ 60Hrc		60 ~ 70Hrc	
반경 Radius	RPM	FEED	RPM	FEED	RPM	FEED	RPM	FEED	RPM	FEED	RPM	FEED
R 0.5	25,600	680	25,600	680	25,600	680	25,600	680	25,600	610	25,600	610
R 0.75	22,000	850	22,000	850	22,000	850	22,000	850	22,000	750	22,000	750
R 1	19,200	1,080	19,200	1,080	19,200	1,080	19,200	1,080	19,200	960	17,600	960
R 2	12,400	1,440	11,200	1,240	10,800	1,160	10,000	1,080	10,000	920	8,800	920
R 3	8,400	1,480	7,600	1,360	7,200	1,280	6,800	1,200	6,800	1,040	5,900	1,040
R 4	6,400	1,120	5,700	1,000	5,500	960	5,100	880	5,100	790	4,400	790
R 5	5,100	880	4,600	800	4,400	784	4,000	720	4,000	640	3,600	640
R 6	4,800	840	3,800	670	3,640	640	3,400	600	3,400	540	3,000	540

절입량  
Depth of Cut

Ap	Ae
0.05D	0.05D

~ 55HRC

Ap	Ae
0.02D	0.05D

~ 70HRC

- 절삭조건에 ap, ae 수치는 황삭 및 황중삭의 수치이므로, 견고한 조도의 가공을 원하시면 황삭 값의 50%를 적용 하십시오.
- 상기 절삭조건은 참고 수치이므로 실 가공시 가공 형상, 가공 목적, 적용 기계에 따라 조건 변경 요망합니다.
- 조건 표가 기계의 최대스핀들 속도를 초과하거나 버 및 적열 현상이 발생할때 스팀들 속도와 이송 속도를 비례하여 조정 하십시오.

- The values of ap and ae on the table are for roughing or semi-roughing. If you need a great surface roughness, apply 50% of the value.
- Use this table for your reference. Adjust the parameters depending on your machining geometry, machining purpose and CNC.
- If the table over the maximum RPM and feed of your machine, or found red heat on the material, adjust RPM and feed in the same proportion.

# 4JJSB/4JJSB Cutting Condition

• RPM : rev./min • Feed : mm/min

피삭재 Material	공구강 / 금형강 Tool Steels / Alloy Steels SCM/HPM	합금강 / 프리하드강 Alloy Steels / Prehardened Steels NAK80/KP4M	스테인레스강 Stainless Steels SUS304/SUS316	고경도강 Hardened Steels STAVAX/SKD11	열처리 / 고경도강 Heat-treated steels / Hardened Steels SKD11/SKD61/YXR7/ R7 / SKH51	열처리 / 고경도강 Heat-treated steels / Hardened Steels SKD11 / SKD61 / YXR7 / R7 / SKH51
경도 Hardness	30 ~ 40Hrc	40 ~ 45Hrc	-	45 ~ 55Hrc	55 ~ 60Hrc	60 ~ 70Hrc
반경 Radius	RPM FEED	RPM FEED	RPM FEED	RPM FEED	RPM FEED	RPM FEED
R 0.5	25,600 806	25,600 806	25,600 806	25,600 806	25,600 723	25,600 723
R 0.75	22,000 1,007	22,000 1,007	22,000 1,007	22,000 1,007	22,000 889	22,000 889
R 1	19,200 1,280	19,200 1,280	19,200 1,280	19,200 1,280	19,200 1,138	17,600 1,138
R 2	12,400 1,706	11,200 1,469	10,800 1,375	10,000 1,280	10,000 1,090	8,800 1,090
R 3	8,400 1,754	7,600 1,612	7,200 1,517	6,800 1,422	6,800 1,232	5,900 1,232
R 4	6,400 1,327	5,700 1,185	5,500 1,138	5,100 1,043	5,100 936	4,400 936
R 5	5,100 1043	4,600 948	4,400 929	4,000 853	4,000 758	3,600 758
R 6	4,800 995	3,800 794	3,640 758	3,400 711	3,400 640	3,000 640

절입량  
Depth of Cut

Ap	Ae
0.05D	0.05D
~ 55HRC	

Ap	Ae
0.02D	0.05D
~ 70HRC	

- 절삭조건인 ap, ae 수치는 황색 및 황중색의 수치 이므로, 견고한 조도의 가공을 원하시면 황색 값의 50%를 적용 하십시오.
- 상기 절삭조건은 참고 수치이므로 실 가공시에는 가공 형상, 가공 목적, 적용 기계 등에 따라 조건을 조정 하십시오.
- 조건 표가 기계의 최대스핀들 속도를 초과 하거나 버 및 적열 현상이 발생할때 스팀들 속도와 이송 속도를 비례하여 조정 하십시오.
- The values of ap and ae on the table are for roughing or semi-roughing. If you need a great surface roughness, apply 50% of the value.
- Use this table for your reference. Adjust the parameters depending on your machining geometry, machining purpose and CNC.
- If the table over the maximum RPM and feed of your machine, or found red heat on the material, adjust RPM and feed in the same proportion.

# 2JJSB/2JJB/3JJB/4JJSB/4JJB

- 3JJB/4JJSB/4JJB 는RPM 동일 , FEED만최대 50% Up 적용
- Use the same RPM and raise up the feed up to 50% for 3JJB/ 4JJSB/ 4JJB

피삭재 Material	고경도강 Hardened Steels STAVAX/SKD11	열처리 / 고경도강 Heat-treated steels / Hardened Steels SKD11 / SKD61	열처리 / 고경도강 Heat-treated steels / Hardened Steels YXR7 / SKH51
경도 Hardness	45 ~ 55Hrc	55 ~ 62Hrc	62 ~ 70Hrc
반경 Radius	RPM FEED	RPM FEED	RPM FEED
R 0.05	60,000 150	60,000 100	52,500 30
R 0.1	60,000 180	60,000 120	45,000 60
R 0.15	45,000 310	43,500 180	32,500 90
R 0.2	37,500 420	35,000 240	26,250 120
R 0.25	33,000 530	30,000 300	22,500 150
R 0.3	30,000 1,200	26,500 800	20,000 400
R 0.4	27,000 1,600	23,500 1,000	17,500 500
R 0.5	24,000 2,000	21,000 1,750	16,000 875
R 0.6	21,000 2,000	18,000 1,750	14,500 875
R 0.75	17,000 2,000	15,000 1,750	11,250 875
R 1	14,000 2,100	12,250 1,800	9,200 900
R 1.25	12,250 2,150	10,700 1,850	8,050 925
R 1.5	10,500 2,200	9,200 1,900	6,900 950
R 2	9,000 2,300	7,900 2,000	5,900 1,000
R 2.5	7,800 2,500	6,800 2,100	5,100 1,050
R 3	6,500 2,500	5,700 2,200	4,300 1,100
R 4	5,200 2,200	4,500 1,900	3,400 950
R 5	4,300 2,000	3,750 1,750	2,800 875
R 6	3,600 1,750	3,150 1,500	2,350 750

절입량 Depth of Cut	<p>Ap : Axial Depth 축방향의절입깊이(mm)              Ae : Radial Depth 반경방향의절입깊이(mm)              D : Outside Diameter 외경(mm)              n : Speed 회전속도 (min<sup>-1</sup>)              Vf : Feed 이송속도 (mm/min)</p>
---------------------	--

- HRC55 이하 피삭재(합금강, 공구강) 가공시 같은 파이에 대비 상기 절삭조건인 20% UP 해주십시오.
- 날수 변화시 회전수는 유지하고, 피드는 안정적인 속도내에서 최대 50%까지 UP 해주십시오. (3JJB, 4JJSB, 4JJB)
- 상기 절삭조건은 참고 수치이므로 실 가공시 가공 형상, 가공 목적, 적용 기계에 따라 조건 변경 요망합니다.
- 조건표가 기계의 최대스핀들 속도를 초과 하거나 버 및 적열 현상이 발생할때 스팀들 속도와 이송 속도를 비례하여 조정 하십시오.
- 진동이 적고 강성이 좋은 공작기계 사용 요망 합니다.(Ø1 이하 사용 시 진동 허용 관리 5µm 이내일 것.)
- 에어브로 혹은 미스트 클린트를 추천 합니다.
- When milling workpiece, HRC below 55 (Alloy steel, tool steel), Raise up 20% RPM and feed compared to the same diameter.
- Changing flutes from 3 to 4, use the same RPM and raise up the feed up to 50% in stable condition (3JJB, 4JJSB, 4JJB).
- Use this table for your reference. Adjust the parameters depending on your machining geometry, machining purpose and CNC.
- If the table over the maximum RPM and feed of your machine, or found red heat on the material, adjust RPM and feed in the same proportion.
- Use a machine with low vibration and good rigidity (Ø1 or less, the vibration tolerance management will be within 5µm).
- Air blow or mist coolants are recommended.

피삭재 Material		합금강 / 프리하드강 Alloy Steels / Prehardened Steels NAK80/KP4M				고경도강 Hardened Steels STAVAX/SKD11				열처리 / 고경도강 Heat-treated steels / Hardened Steels SKD11 / SKD61			
경도 Hardness		40 ~ 45HRC				45 ~ 55HRC				55 ~ 62HRC			
외경 Outside Diameter	유효장 Effective Length	RPM	FEED	Ap Axial Depth	Ae Radial Depth	RPM	FEED	Ap Axial Depth	Ae Radial Depth	RPM	FEED	Ap Axial Depth	Ae Radial Depth
∅ 1	4	24,480	936	0.100	0.100	21,600	699	0.100	0.100	20,160	563	0.100	0.100
"	6	22,032	773	0.040	0.040	19,440	577	0.040	0.040	18,144	465	0.040	0.040
"	8	22,032	773	0.040	0.040	19,440	577	0.040	0.040	18,144	465	0.040	0.040
"	10	22,032	773	0.025	0.025	19,440	577	0.025	0.025	18,144	465	0.025	0.025
"	12	19,584	502	0.025	0.025	17,280	443	0.025	0.025	16,128	348	0.025	0.025
"	14	19,584	502	0.025	0.025	17,280	443	0.025	0.025	16,128	348	0.025	0.025
"	16	19,584	476	0.015	0.015	17,280	373	0.015	0.015	16,128	283	0.015	0.015
∅ 1.2	6	21,760	764	0.084	0.084	19,200	570	0.084	0.084	17,920	460	0.084	0.084
"	8	19,584	687	0.048	0.048	17,280	513	0.048	0.048	16,128	414	0.048	0.048
"	10	19,584	687	0.030	0.030	17,280	513	0.030	0.030	16,128	414	0.030	0.030
"	12	19,584	687	0.030	0.030	17,280	513	0.030	0.030	16,128	414	0.030	0.030
"	16	17,408	611	0.020	0.020	15,360	456	0.020	0.020	14,336	368	0.020	0.020
∅ 1.4	8	19,040	668	0.100	0.100	16,800	499	0.100	0.100	15,680	402	0.100	0.100
"	10	17,136	601	0.056	0.056	15,120	449	0.056	0.056	14,112	362	0.056	0.056
"	14	17,136	601	0.035	0.035	15,120	449	0.035	0.035	14,112	362	0.035	0.035
"	16	15,232	391	0.035	0.035	13,440	345	0.035	0.035	12,544	271	0.035	0.035
∅ 1.5	6	19,040	668	0.110	0.110	16,800	499	0.110	0.110	15,680	402	0.110	0.110
"	8	19,040	668	0.110	0.110	16,800	499	0.110	0.110	15,680	402	0.110	0.110
"	10	17,136	601	0.060	0.060	15,120	449	0.060	0.060	14,112	362	0.060	0.060
"	12	17,136	601	0.060	0.060	15,120	449	0.060	0.060	14,112	362	0.060	0.060
"	14	17,136	601	0.060	0.060	15,120	449	0.060	0.060	14,112	362	0.060	0.060
"	16	15,232	391	0.038	0.038	13,440	345	0.038	0.038	12,544	271	0.038	0.038
"	18	15,232	391	0.038	0.038	13,440	345	0.038	0.038	12,544	271	0.038	0.038
"	20	15,232	391	0.038	0.038	13,440	345	0.038	0.038	12,544	271	0.038	0.038
"	25	11,424	278	0.023	0.023	10,080	218	0.023	0.023	9,408	165	0.023	0.023
∅ 1.6	10	15,912	621	0.040	0.040	14,040	463	0.040	0.040	13,104	373	0.040	0.040
"	14	15,912	621	0.040	0.040	14,040	463	0.040	0.040	13,104	373	0.040	0.040
"	18	15,912	621	0.040	0.040	14,040	463	0.040	0.040	13,104	373	0.040	0.040
∅ 1.8	10	15,912	621	0.072	0.072	14,040	463	0.072	0.072	13,104	373	0.072	0.072
"	14	15,912	621	0.072	0.072	14,040	463	0.072	0.072	13,104	373	0.072	0.072
"	18	15,912	621	0.072	0.072	14,040	463	0.072	0.072	13,104	373	0.072	0.072
∅ 2	6	14,280	668	0.200	0.200	12,600	499	0.200	0.200	11,760	402	0.200	0.200
"	8	14,280	668	0.140	0.140	12,600	499	0.140	0.140	11,760	402	0.140	0.140
"	10	14,280	668	0.140	0.140	12,600	499	0.140	0.140	11,760	402	0.140	0.140
"	12	12,852	601	0.080	0.080	11,340	449	0.080	0.080	10,584	362	0.080	0.080
"	14	12,852	601	0.080	0.080	11,340	449	0.080	0.080	10,584	362	0.080	0.080
"	16	12,852	601	0.080	0.080	11,340	449	0.080	0.080	10,584	362	0.080	0.080
"	18	12,852	601	0.050	0.050	11,340	449	0.050	0.050	10,584	362	0.050	0.050
"	20	12,852	601	0.050	0.050	11,340	449	0.050	0.050	10,584	362	0.050	0.050
"	25	11,424	391	0.050	0.050	10,080	345	0.050	0.050	9,408	271	0.050	0.050
"	30	11,424	391	0.030	0.030	10,080	345	0.030	0.030	9,408	271	0.030	0.030
∅ 2.5	12	12,240	716	0.180	0.180	10,800	535	0.180	0.180	10,080	431	0.180	0.180
"	16	11,116	644	0.100	0.100	9,720	388	0.100	0.100	9,072	388	0.100	0.100
"	20	11,116	644	0.100	0.100	9,720	481	0.100	0.100	9,072	388	0.100	0.100
∅ 3	12	10,880	636	0.210	0.210	9,600	475	0.210	0.210	8,960	383	0.210	0.210
"	16	9,792	573	0.120	0.120	8,640	428	0.120	0.120	8,064	345	0.120	0.120
"	20	9,792	573	0.12	0.120	8,640	428	0.12	0.120	8,064	345	0.12	0.120
"	25	9,792	573	0.08	0.080	8,640	428	0.08	0.080	8,064	345	0.08	0.080
"	30	9,792	573	0.08	0.080	8,640	428	0.08	0.080	8,064	345	0.08	0.080
"	40	8,704	509	0.05	0.050	7,680	380	0.05	0.050	7,168	307	0.05	0.050
∅ 4	12	8,000	1,358	0.4	0.400	7,050	902	0.4	0.400	6,580	727	0.4	0.400
"	16	8,000	1,358	0.4	0.400	7,050	902	0.4	0.400	6,580	727	0.4	0.400
"	20	7,800	1,200	0.3	0.300	6,800	800	0.3	0.300	6,200	720	0.3	0.300
"	25	7,800	1,200	0.3	0.300	6,800	800	0.3	0.300	6,200	720	0.3	0.300
"	30	7,800	1,200	0.3	0.300	6,800	800	0.3	0.300	6,200	720	0.3	0.300
"	35	7,600	1,150	0.2	0.200	6,700	780	0.2	0.200	6,000	700	0.2	0.200
"	40	7,600	1,150	0.2	0.200	6,700	780	0.2	0.200	6,000	700	0.2	0.200
"	45	7,600	1,150	0.2	0.200	6,700	780	0.2	0.200	6,000	700	0.2	0.200
"	50	7,600	1,150	0.2	0.200	6,700	780	0.2	0.200	6,000	700	0.2	0.200
∅ 5	16	7,400	1,060	0.60	0.600	6,600	760	0.4	0.400	5,900	680	0.4	0.400
"	20	7,400	1,060	0.60	0.600	6,600	760	0.4	0.400	5,900	680	0.4	0.400
"	25	7,400	1,060	0.450	0.450	6,600	760	0.3	0.300	5,900	680	0.3	0.300
"	30	7,200	1,000	0.300	0.300	6,200	740	0.2	0.200	5,800	650	0.2	0.200
"	35	7,200	1,000	0.300	0.300	6,200	740	0.2	0.200	5,800	650	0.2	0.200
"	40	7,000	980	0.300	0.300	6,000	700	0.2	0.200	5,600	620	0.2	0.200
"	50	7,000	980	0.300	0.300	6,000	700	0.2	0.200	5,600	620	0.2	0.200
∅ 6	20	6,800	950	0.150	0.150	5,800	680	0.1	0.100	5,400	600	0.1	0.100
"	30	6,800	950	0.150	0.150	5,800	680	0.1	0.100	5,400	600	0.1	0.100

# 2JJRE/4JJRE

■ 4JJRE는 RPM 동일, FEED만 최대 50% Up 적용.  
 ■ Use the same RPM and raise up the feed up to 50% for 4JJRE.

• RPM : rev./min • Feed : mm/min

피삭재 Material		합금강 / 프리하드강 Alloy Steels / Prehardened Steels NAK80/KP4M				고경도강 Hardened Steels STAVAX/SKD11				열처리 / 고경도강 Heat-treated steels / Hardened Steels SKD11 / SKD61			
경도 Hardness		38 ~ 45HRC				45 ~ 55HRC				55 ~ 62HRC			
외경 Outside Diameter	유효장 Effective Length	RPM	FEED	Ap Axial Depth	Ae Radial Depth	RPM	FEED	Ap Axial Depth	Ae Radial Depth	RPM	FEED	Ap Axial Depth	Ae Radial Depth
∅	40	6800	950	0.150	0.150	5800	680	0.1	0.100	5400	600	0.1	0.100
∅	50	6500	900	0.135	0.135	5600	650	0.09	0.090	5000	560	0.09	0.090
∅	60	6500	900	0.135	0.135	5600	650	0.09	0.090	5000	560	0.09	0.090

**절입량**  
Depth of Cut

Slotting

- Ap : Axial Depth
- D : Outside Diameter

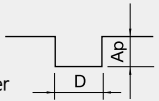

Side Milling

- Ap : Axial Depth
- Ae : Radial Depth

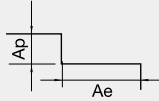

- 4날시 회전수는 유지하고, 피드는 안정적인 속도내에서 최대 50%까지 UP 해주십시오.
- 날 끝이 정밀하게 연삭되어 있습니다. 파손을 피하기 위해 가능하면 비접촉 방식으로 측정 하십시오.
- HRC65 이상 고경도강 가공 시 같은 직경의 같은 비율로 20% DOWN 해주십시오.
- 상기 절삭조건은 참고 수치이므로 실 가공시에는 가공 형상, 가공 목적, 적용 기계 등에 따라 조건을 조정 하십시오.
- 조건 표가 기계의 최대스핀들 속도를 초과 하거나 버 및 적열 현상이 발생할때 스펀들 속도와 이송 속도를 비례하여 조정 하십시오.
- 진동이 적고 강성이 좋은 공작기계 사용 요망 합니다.(∅1 이하 사용 시 진동 허용 관리 5 $\mu$ m 이내일 것.)
- 에어브로, 절삭유, 오일미스트 콜러트를 추천하며, 칩을 잘 제거하고 가공시 발열과 발화에 주의 하십시오
- For 4JJRE, use the same RPM and raise up the feed up to 50% in stable condition.
- The edge of the flute precisely grinded. If you want to measure the tool, and to avoid damaging on the flutes, use non-contact measuring method.
- When milling hardened material, HRC over 65, decrease by 20% RPM and feed compared to the same diameter.
- Use this table for your reference. Adjust the parameters depending on your machining geometry, machining purpose and CNC.
- If the table over the maximum RPM and feed of your machine, or found red heat on the material, adjust RPM and feed in the same proportion.
- Use a machine with low vibration and good rigidity ( $\emptyset 1$  or less, the vibration tolerance management will be within 5 $\mu$ m.)
- Air blow or mist coolants are recommended and note for chip emission, heat or ignition.

# 4JJE Cutting Condition

# 4JJHE

688JJHE : RPM 동일, FEED만 최대 50% Up 적용.  
 Use the same RPM, raise up the feed up to 50%

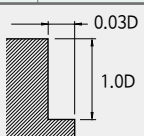
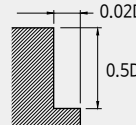
피삭재 Material	합금강 / 프리하드강 Alloy Steels / Prehardened Steels NAK80/KP4M		고경도강 Hardened Steels STAVAX/SKD11		피삭재 Material	열처리 / 고경도강 Heat-treated steels / Hardened Steels SKD11 / SKD61				열처리 / 고경도강 Heat-treated steels / Hardened Steels YXR7 / SKH51			
	경도 Hardness	40 ~ 45HRC	45 ~ 55HRC	경도 Hardness		55 ~ 62HRC		62 ~ 70HRC					
외경 Outside Diameter	RPM	FEED	RPM	FEED	외경 Outside Diameter	RPM	FEED	Ap Axial Depth	Ae Radial Depth	RPM	FEED	Ap Axial Depth	Ae Radial Depth
∅ 1	31,500	1,050	20,300	710	∅ 1	32,000	800	0.5	0.02	28,000	500	0.5	0.02
∅ 2	20,200	1,250	14,300	840	∅ 1.5	30,000	900	0.75	0.03	25,000	550	0.75	0.03
∅ 3	14,300	1,250	8,500	840	∅ 2	24,000	1,000	1	0.04	16,000	600	1	0.04
∅ 4	11,400	1,300	7,200	880	∅ 3	38,400	1,600	1.5	0.06	19,200	1,140	1.5	0.06
∅ 5	10,500	1,500	6,700	1,000	∅ 4	28,800	1,850	2	0.08	14,400	1,320	2	0.08
∅ 6	8,450	1,400	5,600	950	∅ 5	24,000	2,100	2.5	0.1	12,000	1,500	2.5	0.1
∅ 7	7,800	1,380	4,200	900	∅ 6	19,200	2,430	3	0.12	9,600	1,740	3	0.12
∅ 8	6,500	1,350	3,830	840	∅ 8	14,400	2,430	4	0.16	7,200	1,740	4	0.16
∅ 9	6,150	1,260	3,500	840	∅ 10	11,520	2,430	5	0.2	5,760	1,740	5	0.2
∅ 10	5,250	1,260	2,800	800	∅ 12	9,600	2,010	6	0.24	4,800	1,440	6	0.24
∅ 11	4,300	1,150	2,500	800	∅ 16	7,200	1,500	8	0.32	3,600	1,080	8	0.32
∅ 12	4,300	1,150	2,300	760	∅ 20	5,760	1,200	10	0.4	2,880	850	10	0.4
∅ 14	3,500	1,050	2,100	760	<p><b>절입량</b> Depth of Cut</p> <div style="display: flex; justify-content: space-around;"> <div style="text-align: center;"> <p>~ 55HRC</p>  </div> <div style="text-align: center;"> <p>55HRC ~</p>  </div> </div>								
∅ 16	3,500	1,050	2,000	700									
∅ 18	2,800	1,000	2,000	700									
∅ 20	2,600	980	1,800	650									

- HRC55 이하 피삭재(합금강, 공구강) 가공시 같은 파이에 대비 상기 절삭조건외의 20% UP 해주십시오.
- JJHE의 6~8날 가공시 회전수는 유지하고, 안정적인 속도내에서 피드를 최대 50%까지 UP 해주십시오.
- JJHE Series 제품은 홈절삭보다 측면절삭에 효율이 높은점 참고 바랍니다.
- 상기 절삭조건은 참고 수치이므로 실 가공시 가공 형상, 가공 목적, 적용 기계에 따라 조건 변경 요망합니다.
- 조건표가 기계의 최대스핀들 속도를 초과 하거나 버 및 적열 현상이 발생할때 스펀들 속도와 이송 속도를 비례하여 조정 하십시오.
- 소재 및 가공 형상에 적합한 절삭유를 사용하십시오.
- When milling workpiece, HRC below 55 (Alloy steel, tool steel), Raise up 20% RPM and feed compared to the same diameter.
- For 6~8 flutes of JJHE, keep the RPM and raise up the feed up to 50% in the stable milling condition.
- Note that JJHE series performs better in side milling rather than groove milling.
- Use this table for your reference. Adjust the parameters depending on your machining geometry, machining purpose and CNC.
- If the table over the maximum RPM and feed of your machine, or found red heat on the material, adjust RPM and feed in the same proportion.
- Use suitable cutting oil for material and machining geometry.

피삭재 Material	홈 절삭 Slotting						측면절삭 Side Cutting											
	고경도강 Hardened Steels STAVAX/SKD11		열처리 / 고경도강 Heat-treated steels / Hardened Steels SKD11 / SKD61		열처리 / 고경도강 Heat-treated steels / Hardened Steels YXR7 / SKH51		고경도강 Hardened Steels STAVAX/SKD11		열처리 / 고경도강 Heat-treated steels / Hardened Steels SKD11 / SKD61		열처리 / 고경도강 Heat-treated steels / Hardened Steels YXR7 / SKH51							
경도 Hardness	45 ~ 55HRC		55 ~ 65HRC		62 ~ 70HRC		45 ~ 55HRC		55 ~ 62HRC		62 ~ 70HRC							
외경 Outside Diameter	RPM	FEED	RPM	FEED	RPM	FEED	RPM	FEED	RPM	FEED	RPM	FEED						
∅ 0.1	33,000	50	33,000	40	26,400	30	• 측면절삭불가 • Side cutting is not possible.											
∅ 0.2	33,000	60	33,000	45	20,000	35												
∅ 0.3	33,000	70	25,000	50	20,000	40												
∅ 0.4	33,000	90	25,000	55	20,000	60												
∅ 0.5	33,000	140	25,000	85	20,000	75												
∅ 0.6	30,000	160	25,000	105	15,200	80												
∅ 0.8	25,000	185	19,000	110	14,000	90												
∅ 0.9	22,700	205	17,500	125	12,500	85												
∅ 1	20,500	670	16,000	340	12,500	160							20,500	775	16,000	340	12,500	323
∅ 2	14,500	800	11,000	400	9,500	210							14,500	925	11,000	415	9,500	394
∅ 3	9,500	800	7,500	400	6,400	210	9,500	925	7,500	415	6,400	394						
∅ 4	7,200	840	5,600	425	4,750	220	7,200	960	5,600	430	4,750	409						
∅ 5	6,400	885	5,100	450	4,450	245	6,400	1,020	5,100	470	4,450	447						
∅ 6	5,300	870	4,200	450	3,700	240	5,300	1,000	4,200	460	3,700	437						
∅ 8	4,000	800	3,200	400	2,800	220	4,000	910	3,200	425	2,800	404						
∅ 10	3,200	750	2,550	390	2,200	210	3,200	850	2,550	400	2,200	380						
∅ 12	2,650	750	2,100	390	1,860	210	2,650	850	2,100	400	1,860	380						
∅ 16	1,840	560	1,800	250	1,460	185	1,840	750	1,800	340	1,800	323						
∅ 18	1,840	560	1,800	250	1,460	185	1,840	750	1,800	340	1,800	323						
∅ 20	1,460	560	1,400	250	1,100	185	1,460	750	1,400	325	1,400	309						
절입량 Depth of Cut																		

- HRC55 이하 피삭재 (합금강, 공구강) 가공시 같은 파이에 대비 상기 절삭조건 20% UP 해주십시오.
- 상기 절삭조건은 참고 수치이므로 실가 공시 가공 형상, 가공 목적, 적용 기계에 따라 조건 변경 요망합니다.
- 조건표가 기계의 최대스핀들 속도를 초과 하거나 버 및 적열 현상이 발생할때 스펙들 속도와 이송 속도를 비례하여 조정 하십시오.
- 소재 및 가공 형상에 적합한 절삭유를 사용하십시오.

- When milling workpiece, HRC below 55 (Alloy steel, tool steel), Raise up 20% RPM and feed compared to the same diameter.
- Use this table for your reference. Adjust the parameters depending on your machining geometry, machining purpose and CNC.
- If the table over the maximum RPM and feed of your machine, or found red heat on the material, adjust RPM and feed in the same proportion.
- Use suitable cutting oil for material and machining geometry.

홈절삭 Slotting													
피삭재 Material		고경도강 Hardened Steels STAVAX/SKD11				열처리 / 고경도강 Heat-treated steels / Hardened Steels SKD11 / SKD61				열처리 / 고경도강 Heat-treated steels / Hardened Steels YXR7 / SKH51			
경도 Hardness		45 ~ 55HRC				55 ~ 62HRC				62 ~ 70HRC			
외경 Outside Diameter	반경 Corner Radius	RPM	FEED	Ap Axial Depth	Ae Radial Depth	RPM	FEED	Ap Axial Depth	Ae Radial Depth	RPM	FEED	Ap Axial Depth	Ae Radial Depth
ø 0.4	R 0.1	33,000	105	0.01	0.01	25,000	60	0.005	0.008	25,000	60	0.005	0.008
ø 0.5	R 0.1	33,000	110	0.015	0.02	25,000	65	0.007	0.010	20,000	40	0.007	0.010
ø 0.8	R 0.2	30,000	125	0.02	0.10	25,000	85	0.01	0.075	20,000	50	0.01	0.075
ø 1	R 0.3	25,000	226	0.04	0.15	19,000	131	0.02	0.12	16,000	74	0.02	0.12
ø 1.5	R 0.5	20,500	268	0.10	0.30	16,000	157	0.05	0.20	12,500	95	0.05	0.20
ø 2	R 0.5	14,500	324	0.15	0.50	11,000	186	0.1	0.25	9,500	124	0.10	0.30
ø 2.5	R 0.5	9,500	324	0.20	0.50	7,500	186	0.12	0.35	6,400	124	0.12	0.40
ø 3	R 0.5	9,500	324	0.20	0.50	7,500	186	0.12	0.35	6,400	124	0.12	0.40
ø 4	R 0.3	7,200	337	0.25	0.30	5,600	197	0.15	0.20	4,750	127	0.15	0.30
ø 5	R 0.5	6,400	356	0.25	0.50	5,100	209	0.15	0.50	4,450	142	0.15	0.40
"	R 1	6,400	356	0.40	1.05	5,100	209	0.35	0.80	4,450	142	0.30	0.70
ø 6	R 0.5	5,300	349	0.20	0.70	4,200	209	0.2	0.60	3,700	140	0.20	0.50
"	R 1	5,300	349	0.30	1.00	4,200	209	0.3	0.80	3,700	140	0.20	0.65
"	R 1.5	5,300	349	0.50	1.30	4,200	209	0.4	1.00	3,700	140	0.30	0.80
ø 8	R 0.5	4,000	318	0.30	0.70	3,200	191	0.20	0.60	2,800	130	0.20	0.50
"	R 1	4,000	318	0.40	1.00	3,200	191	0.25	0.90	2,800	130	0.25	0.70
"	R 1.5	4,000	318	0.40	1.30	3,200	191	0.25	1.20	2,800	130	0.25	0.80
ø 10	R 0.5	3,200	300	0.40	0.80	2,550	180	0.2	0.60	2,200	122	0.20	0.50
"	R 1	3,200	300	0.50	1.00	2,550	180	0.3	0.80	2,200	122	0.30	0.80
"	R 2	3,200	300	0.50	1.70	2,550	180	0.3	1.50	2,200	122	0.30	1.30
ø 12	R 0.5	2,650	300	0.50	1.00	2,100	180	0.35	0.80	1,860	122	0.20	0.60
"	R 1	2,650	300	0.60	1.30	2,100	180	0.35	1.20	1,860	122	0.30	1.00
"	R 2	2,650	300	0.60	1.80	2,100	180	0.35	1.70	1,860	122	0.30	1.40
"	R 3	2,650	300	0.60	2.50	2,100	180	0.40	2.00	1,860	122	0.30	1.80

측면절삭 Side Cutting													
피삭재 Material		고경도강 Hardened Steels STAVAX/SKD11				열처리 / 고경도강 Heat-treated steels / Hardened Steels SKD11 / SKD61				열처리 / 고경도강 Heat-treated steels / Hardened Steels YXR7 / SKH51			
경도 Hardness		45 ~ 55HRC				55 ~ 62HRC				62 ~ 70HRC			
외경 Outside Diameter		RPM	FEED	Ap Axial Depth	Ae Radial Depth	RPM	FEED	Ap Axial Depth	Ae Radial Depth	RPM	FEED	Ap Axial Depth	Ae Radial Depth
ø 0.4		33,000	105	0.40	0.012	25,000	60	0.2	0.008	25,000	60	0.2	0.008
ø 0.5		33,000	110	0.50	0.015	25,000	65	0.25	0.010	20,000	40	0.25	0.010
ø 0.8		30,000	125	0.80	0.024	25,000	85	0.4	0.016	20,000	50	0.4	0.016
ø 1		25,000	145	1.00	0.030	19,000	128	0.5	0.02	16,000	74	0.5	0.02
ø 2		14,500	208	2.00	0.060	11,000	129	1	0.04	9,500	76	1	0.04
ø 3		9,500	208	3.00	0.090	7,500	131	1.5	0.06	6,400	77	1.5	0.06
ø 4		7,200	216	4.00	0.120	5,600	132	2	0.08	4,750	78	2	0.08
ø 6		5,300	224	6.00	0.180	4,200	133	3	0.12	3,700	80	3	0.12
ø 8		4,000	204	8.00	0.240	3,200	135	4	0.16	2,800	81	4	0.16
ø 10		3,200	192	10.00	0.300	2,550	136	5	0.20	2,200	82	5	0.20
ø 12		2,650	192	12.00	0.360	2,100	138	6	0.24	1,860	84	6	0.24

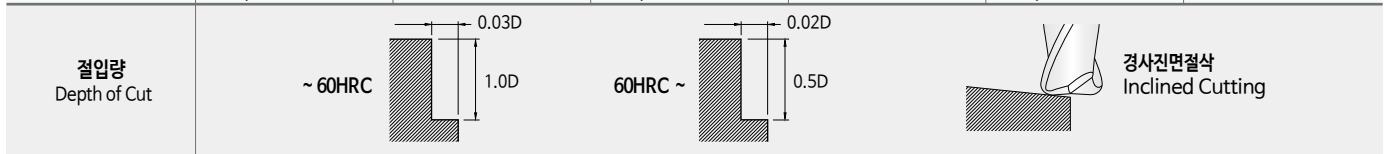

- HRC55 이하 피삭재(합금강, 공구강) 가공시 같은 파이에 대비 상기 절삭조건외의 20% UP 해주십시오.
- 유효장이 긴 경우에는 회전수와 이송속도를 최대30% 이하로 줄이십시오.
- 측면 절삭시 코너R 부분과 각도내용을 참고하여 절삭 하시기 바랍니다.
- 곡면 절삭시 날경의 코너R 보다 낮은 이동 PITCH를 설정 하십시오.
- 곡면 절삭시 안정적인 속도 내에서 피드를 최대 30%까지 UP 해주십시오.
- 상기 절삭조건은 참고 수치이므로 실 가공시 가공 형상, 가공 목적, 적용 기계에 따라 조건 변경 요망합니다.
- 에어브로, 절삭유, 오일미스트 콜러트를 추천하며, 칩을 잘 제거하고 가공시 발열과 발화에 주의 하십시오
- When milling workpiece, HRC below 55 (Alloy steel, tool steel), Raise up 20% RPM and feed compared to the same diameter.
- In case of long effective length, reduce the RPM and feed by 30% or less.
- For side milling, refer to the corner radius and
- For curved milling, set up the lower value of the pitch than the corner radius value of tool diameter.
- For curved milling, raise up the feed by 30% in stable condition.
- Use this table for your reference. Adjust the parameters depending on your machining geometry, machining purpose and CNC.
- Air blow or mist coolants are recommended and note for chip emission, heat, or ignition.

# 4JJCR/6JJCR/4JJTC

- 6JJCR은 RPM 동일, FEED만 최대 50% Up 적용.
- Use the same RPM and raise up the feed up to 50% for 6JJCR.

피삭재 Material		고경도강 Hardened Steels STAVAX/SKD11				열처리 / 고경도강 Heat-treated steels / Hardened Steels SKD11 / SKD61				열처리 / 고경도강 Heat-treated steels / Hardened Steels YXR7 / SKH51			
경도 Hardness		45 ~ 55Hrc				55 ~ 62Hrc				62 ~ 70Hrc			
외경 Outside Diameter	반경 Corner Radius	RPM	FEED	Ap Axial Depth	Ae Radial Depth	RPM	FEED	Ap Axial Depth	Ae Radial Depth	RPM	FEED	Ap Axial Depth	Ae Radial Depth
ø 0.5	R 0.1	33,000	365	0.015	0.013	25,000	245	0.007	0.010	20,000	140	0.007	0.010
ø 0.6	R 0.1	30,000	380	0.02	0.098	25,000	250	0.01	0.075	20,000	150	0.01	0.075
ø 0.7	R 0.1	28,000	390	0.03	0.104	21,000	255	0.01	0.080	18,000	150	0.01	0.080
ø 0.8	R 0.1	25,500	400	0.04	0.120	19,000	260	0.02	0.10	16,000	155	0.02	0.10
ø 1	R 0.1	20,500	710	0.08	0.156	16,000	392	0.04	0.12	12,500	236	0.03	0.12
"	R 0.3	20,500	710	0.10	0.104	16,000	393	0.05	0.08	12,500	238	0.05	0.06
ø 1.5	R 0.1	18,000	759	0.12	0.125	13,000	394	0.07	0.10	10,500	239	0.05	0.08
"	R 0.5	18,000	759	0.15	0.156	13,000	396	0.10	0.12	10,500	240	0.07	0.10
ø 2	R 0.1	14,500	858	0.15	0.156	11,000	397	0.10	0.12	9,500	242	0.10	0.10
"	R 0.5	14,500	858	0.18	0.187	11,000	399	0.10	0.14	9,500	243	0.10	0.12
ø 2.5	R 0.1	11,500	858	0.16	0.166	8,500	400	0.10	0.13	7,500	244	0.10	0.10
"	R 0.5	11,500	858	0.19	0.198	8,500	402	0.10	0.15	7,500	246	0.10	0.12
ø 3	R 0.1	9,500	858	0.16	0.166	7,500	403	0.12	0.13	6,400	247	0.12	0.10
"	R 0.5	9,500	858	0.18	0.187	7,500	405	0.12	0.14	6,400	248	0.12	0.12
"	R 1	9,500	858	0.20	0.208	7,500	406	0.12	0.16	6,400	250	0.12	0.13
ø 4	R 0.1	7,200	891	0.20	0.208	5,600	407	0.12	0.16	4,750	251	0.12	0.13
"	R 0.5	7,200	891	0.25	0.260	5,600	409	0.12	0.20	4,750	252	0.15	0.16
"	R 1	7,200	891	0.25	0.260	5,600	410	0.15	0.20	4,750	254	0.15	0.16
ø 5	R 0.1	6,400	957	0.25	0.260	5,100	412	0.12	0.20	4,450	255	0.12	0.16
"	R 0.5	6,400	957	0.28	0.291	5,100	413	0.15	0.22	4,450	257	0.15	0.18
"	R 1	6,400	957	0.30	0.312	5,100	415	0.15	0.24	4,450	258	0.15	0.19
ø 6	R 0.1	5,300	924	0.30	0.312	4,200	416	0.20	0.24	3,700	259	0.20	0.19
"	R 0.5	5,300	924	0.30	0.312	4,200	418	0.20	0.24	3,700	261	0.20	0.19
"	R 1	5,300	924	0.40	0.416	4,200	419	0.25	0.32	3,700	262	0.25	0.26
"	R 1.5	5,300	924	0.40	0.416	4,200	421	0.25	0.32	3,700	263	0.25	0.26
ø 8	R 0.5	4,000	858	0.30	0.312	3,200	422	0.20	0.24	2,800	265	0.20	0.19
"	R 1	4,000	858	0.30	0.312	3,200	423	0.20	0.24	2,800	266	0.20	0.19
"	R 1.5	4,000	858	0.40	0.416	3,200	425	0.25	0.32	2,800	267	0.25	0.26
"	R 2	4,000	858	0.50	0.520	3,200	426	0.30	0.40	2,800	269	0.25	0.32
ø 10	R 0.5	3,200	792	0.40	0.416	2,550	428	0.20	0.32	2,200	270	0.20	0.26
"	R 1	3,200	792	0.45	0.468	2,550	429	0.25	0.36	2,200	271	0.25	0.29
"	R 1.5	3,200	792	0.50	0.520	2,550	431	0.30	0.40	2,200	273	0.30	0.32
"	R 2	3,200	792	0.50	0.520	2,550	432	0.30	0.40	2,200	274	0.30	0.32
"	R 2.5	3,200	792	0.50	0.520	2,550	434	0.30	0.40	2,200	275	0.30	0.32
ø 12	R 0.5	2,650	792	0.50	0.520	2,100	435	0.35	0.40	1,860	277	0.30	0.32
"	R 1	2,650	792	0.70	0.728	2,100	436	0.35	0.56	1,860	278	0.35	0.45
"	R 1.5	2,650	792	0.80	0.832	2,100	438	0.40	0.64	1,860	279	0.35	0.51
"	R 2	2,650	792	0.80	0.832	2,100	439	0.40	0.64	1,860	281	0.35	0.51
"	R 3	2,650	792	0.80	0.832	2,100	441	0.40	0.64	1,860	282	0.35	0.51

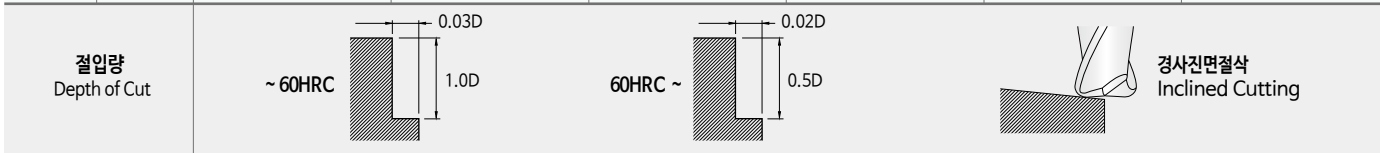

- 상기 조건표는 홈 절삭 조건표이며, 측면 절삭시 절입기준표를 참고바랍니다.
- HRC55 이하 피삭재(합금강, 공구강) 가공시 같은 파이에 대비 상기 절삭조건 20% UP 해주십시오.
- 유효장이 긴 경우에는 회전수와 이송속도를 최대30% 이하로 줄이십시오.
- 곡면 절삭시 날경의 코너R 보다 낮은 이동 PITCH를 설정 하십시오.
- 곡면 절삭시 안정적인 속도 내에서 피드를 최대 30%까지 UP 해주십시오.
- 6날시 회전수는 유지하고, 피드는 안정적인 속도 내에서 최대 50%까지 UP 해주십시오.
- Above the table is a reference for groove milling, and refer to the depth of cut for side milling.
- When milling workpiece, HRC below 55 (Alloy steel, tool steel), Raise up 20% RPM and feed compared to the same diameter.
- In case of long effective length, reduce the RPM and feed by 30% or less.
- For curved milling, use the lower value of pitch than corner radius value of tool diameter.
- For curved milling, raise up the feed up to 30% in stable condition.
- With 6flutes milling, raise up the feed up to 50% in stable condition.



피삭재 Material		고경도강 Hardened Steels STAVAX/SKD11				열처리 / 고경도강 Heat-treated steels / Hardened Steels SKD11 / SKD61				열처리 / 고경도강 Heat-treated steels / Hardened Steels YXR7 / SKH51			
경도 Hardness		45 ~ 55HRC				55 ~ 62HRC				62 ~ 70HRC			
외경 Outside Diameter	반경 Corner Radius	RPM	FEED	Ap Axial Depth	Ae Radial Depth	RPM	FEED	Ap Axial Depth	Ae Radial Depth	RPM	FEED	Ap Axial Depth	Ae Radial Depth
ø 0.2	R0.02	40,000	55	0.005	0.005	37,000	30	0.002	0.005	36,000	30	0.003	0.005
ø 0.3	R0.02	40,000	60	0.007	0.007	37,000	35	0.003	0.006	36,000	35	0.004	0.006
ø 0.4	R0.1	33,000	70	0.010	0.01	25,000	40	0.005	0.008	25,000	40	0.005	0.008
ø 0.5	R0.1	33,000	80	0.015	0.02	25,000	45	0.007	0.010	20,000	30	0.007	0.010
ø 0.6	R0.2	30,000	90	0.02	0.10	25,000	60	0.01	0.075	20,000	35	0.01	0.075
ø 0.8	R0.2	25,000	100	0.04	0.15	19,000	65	0.02	0.12	16,000	40	0.02	0.12
ø 1	R0.3	20,500	583	0.10	0.30	16,000	281	0.05	0.20	12,500	175	0.05	0.20
ø 1.5	R0.1	16,500	623	0.12	0.35	13,000	283	0.07	0.30	10,500	177	0.07	0.30
ø 2	R0.1	14,500	696	0.15	0.40	11,000	285	0.10	0.35	9,500	179	0.10	0.30
ø 2.5	R0.1	11,500	696	0.20	0.60	8,800	287	0.12	0.40	7,400	180	0.10	0.35
"	R0.5	11,500	696	0.21	0.60	8,800	289	0.12	0.45	7,400	182	0.10	0.40
ø 3	R0.1	9,500	705	0.20	0.50	7,500	290	0.15	0.55	6,400	184	0.12	0.45
"	R0.5	9,500	705	0.22	0.50	7,500	292	0.15	0.55	6,400	186	0.12	0.45
"	R1	9,500	705	0.25	0.70	7,500	294	0.20	0.65	6,400	187	0.16	0.55
ø 4	R0.1	7,200	724	0.25	0.95	5,600	296	0.15	0.75	4,750	189	0.15	0.65
"	R0.5	7,200	724	0.25	0.95	5,600	298	0.15	0.75	4,750	191	0.15	0.65
"	R1	7,200	724	0.30	1.20	5,600	300	0.20	1.00	4,750	193	0.20	0.90
ø 5	R0.1	6,400	771	0.20	0.90	5,100	302	0.15	0.70	4,450	194	0.15	0.85
"	R0.5	6,400	771	0.20	0.90	5,100	303	0.15	0.70	4,450	196	0.15	0.85
"	R1	6,400	771	0.25	1.10	5,100	305	0.20	0.90	4,450	198	0.20	1.00
ø 6	R0.5	5,300	752	0.30	1.30	4,200	307	0.20	0.80	3,700	200	0.20	0.80
"	R1	5,300	752	0.30	1.30	4,200	309	0.20	0.80	3,700	201	0.20	0.80
"	R1.5	5,300	752	0.30	1.40	4,200	311	0.25	1.20	3,700	203	0.25	1.20
"	R2.5	5,300	752	0.30	1.40	4,200	313	0.25	1.20	3,700	205	0.25	1.20
ø 8	R0.5	4,000	686	0.30	1.70	3,200	315	0.25	1.35	2,800	207	0.25	1.35
"	R1	4,000	686	0.30	1.70	3,200	316	0.25	1.35	2,800	208	0.25	1.35
"	R1.5	4,000	686	0.30	1.70	3,200	318	0.25	1.35	2,800	210	0.25	1.35
"	R2	4,000	686	0.40	2.00	3,200	320	0.25	1.50	2,800	212	0.30	1.40
"	R2.5	4,000	686	0.40	2.00	3,200	322	0.25	1.50	2,800	214	0.30	1.40
"	R3	4,000	686	0.40	2.00	3,200	324	0.25	1.50	2,800	215	0.30	1.40
ø 10	R0.5	3,200	639	0.50	2.10	2,550	326	0.30	1.70	2,200	217	0.30	1.50
"	R1	3,200	639	0.50	2.10	2,550	327	0.30	1.70	2,200	219	0.30	1.50
"	R1.5	3,200	639	0.60	2.40	2,550	329	0.30	1.80	2,200	221	0.30	1.60
"	R2	3,200	639	0.60	2.40	2,550	331	0.30	1.80	2,200	222	0.30	1.60
"	R2.5	3,200	639	0.60	2.40	2,550	333	0.30	1.80	2,200	224	0.30	1.60
ø 12	R0.5	2,650	639	0.80	2.50	2,100	335	0.40	2.00	1,860	226	0.35	1.80
"	R1	2,650	639	0.80	2.50	2,100	337	0.40	2.00	1,860	228	0.35	1.80
"	R1.5	2,650	639	0.80	2.50	2,100	339	0.40	2.00	1,860	229	0.35	1.80
"	R2	2,650	639	1.00	2.60	2,100	340	0.50	2.10	1,860	231	0.40	2.00
"	R2.5	2,650	639	1.00	2.60	2,100	342	0.50	2.10	1,860	233	0.40	2.00
"	R3	2,650	639	1.00	2.60	2,100	344	0.50	2.10	1,860	235	0.40	2.00



- 상기 조건표는 홈 절삭 조건표이며, 실 가공시 가공 형상, 가공 목적, 적용 기계에 따라 조건변경 요망 합니다.
- 곡면 절삭시 날경의 코너R 보다 낮은 이동 PITCH를 설정 하십시오.
- 곡면 절삭시 안정적인 속도 내에서 피드를 최대30%까지 UP 해주십시오.
- 적용 기계의 회전속도가 부족한 경우에는 회전 속도와 이송 속도를 같은 비율로 줄여서 적용합니다.
- 에어브로 혹은 미스트 콜러트를 추천하며 칩 제거 주의 및 가공시 발열, 발화에 주의 하십시오.
- Above the table is a reference for groove milling, and adjust parameters depending on material shape, milling purpose, and CNC machine.
- For curved milling, set up the pitch value lower than corner radius value.
- For curved milling, raise up the feed up to 30% in stable condition.
- If the table over the maximum RPM and feed of your machine, adjust RPM and feed in the same proportion.
- Air blow or mist coolant is recommended and note for chip emission, heat, or ignition.

피삭재 Material		고경도강 Hardened Steels STAVAX/SKD11				열처리 / 고경도강 Heat-treated steels / Hardened Steels SKD11 / SKD61				열처리 / 고경도강 Heat-treated steels / Hardened Steels YXR7 / SKH51			
경도 Hardness		45 ~ 55HRc				55 ~ 62HRc				62 ~ 70HRc			
외경 Outside Diameter	반경 Corner Radius	RPM	FEED	Ap Axial Depth	Ae Radial Depth	RPM	FEED	Ap Axial Depth	Ae Radial Depth	RPM	FEED	Ap Axial Depth	Ae Radial Depth
ø 0.5	R 0.1	33,000	85	0.01	0.01	25,000	55	0.01	0.01	25,000	45	0.01	0.01
ø 0.6	R 0.1	33,000	95	0.02	0.02	25,000	60	0.01	0.01	20,000	50	0.01	0.01
ø 0.7	R 0.1	30,000	115	0.02	0.10	25,000	75	0.01	0.08	20,000	55	0.01	0.08
ø 0.8	R 0.1	25,000	120	0.04	0.15	19,000	85	0.02	0.12	16,000	60	0.02	0.12
ø 0.9	R 0.1	23,000	160	0.06	0.18	17,500	110	0.03	0.15	14,500	95	0.03	0.14
ø 1	R 0.3	20,500	344	0.10	0.30	16,000	216	0.05	0.20	12,500	140	0.05	0.20
ø 1.5	R 0.1	18,000	388	0.10	0.30	13,000	235	0.07	0.30	10,500	160	0.08	0.25
"	R 0.5	18,000	388	0.13	0.40	13,000	235	0.07	0.30	10,500	160	0.08	0.25
ø 2	R 0.1	14,500	416	0.15	0.50	11,000	256	0.10	0.45	9,500	184	0.10	0.45
"	R 0.5	14,500	416	0.15	0.50	11,000	256	0.10	0.45	9,500	184	0.10	0.45
ø 2.5	R 0.1	9,500	416	0.20	0.70	7,500	256	0.12	0.55	6,400	184	0.12	0.55
"	R 0.5	9,500	416	0.20	0.70	7,500	256	0.12	0.55	6,400	184	0.12	0.55
ø 3	R 0.5	8,300	424	0.23	0.80	6,400	268	0.13	0.60	5,600	192	0.13	0.60
"	R 1	8,300	424	0.23	0.80	6,400	268	0.13	0.60	5,600	192	0.13	0.60
ø 3.5	R 0.5	7,800	432	0.25	0.90	6,000	268	0.13	0.70	5,200	192	0.14	0.70
ø 4	R 0.5	7,200	432	0.25	0.95	5,600	268	0.15	0.75	4,750	192	0.15	0.75
"	R 1	7,200	432	0.25	1.00	5,600	268	0.15	0.80	4,750	192	0.15	0.80
ø 4.5	R 0.5	6,400	464	0.25	1.05	5,100	296	0.15	0.85	4,450	216	0.15	0.85
ø 5	R 0.5	6,400	464	0.25	1.05	5,100	296	0.15	0.85	4,450	216	0.15	0.85
"	R 1	6,400	464	0.30	1.20	5,100	296	0.17	0.90	4,450	216	0.17	0.85
ø 6	R 0.5	5,300	448	0.30	1.30	4,200	280	0.20	1.00	3,700	208	0.20	0.90
"	R 1	5,300	448	0.30	1.40	4,200	296	0.20	1.00	3,700	216	0.20	0.90
"	R 1.5	5,300	448	0.35	1.50	4,200	280	0.23	1.20	3,700	208	0.22	1.20
"	R 2	5,300	448	0.35	1.60	4,200	296	0.23	1.20	3,700	216	0.22	1.20
ø 8	R 0.5	4,000	416	0.40	1.70	3,200	264	0.25	1.35	2,800	192	0.25	1.30
"	R 1	4,000	416	0.40	1.70	3,200	264	0.25	1.35	2,800	192	0.25	1.30
"	R 1.5	4,000	416	0.45	2.00	3,200	264	0.28	1.50	2,800	192	0.27	1.40
"	R 2	4,000	416	0.45	2.00	3,200	264	0.28	1.50	2,800	192	0.27	1.40
ø 10	R 0.5	3,200	384	0.50	2.10	2,550	248	0.30	1.70	2,200	176	0.30	1.70
"	R 1	3,200	384	0.50	2.10	2,550	248	0.30	1.70	2,200	176	0.30	1.70
"	R 1.5	3,200	384	0.55	2.30	2,550	248	0.35	1.80	2,200	176	0.35	1.80
"	R 2	3,200	384	0.55	2.30	2,550	248	0.35	1.90	2,200	176	0.35	1.90
"	R 2.5	3,200	384	0.60	2.30	2,550	248	0.35	1.90	2,200	176	0.35	1.90
ø 12	R 0.5	2,650	384	0.60	2.60	2,100	240	0.35	2.00	1,860	176	0.35	2.00
"	R 1	2,650	384	0.60	2.60	2,100	240	0.35	2.00	1,860	176	0.35	2.00
"	R 1.5	2,650	384	0.60	2.60	2,100	240	0.35	2.00	1,860	176	0.35	2.00
"	R 2	2,650	384	0.60	2.60	2,100	240	0.35	2.00	1,860	176	0.35	2.00
"	R 2.5	2,650	384	0.80	3.00	2,100	240	0.50	2.20	1,860	176	0.45	2.30
"	R 3	2,650	384	1.00	3.00	2,100	240	0.65	2.40	1,860	176	0.55	2.50



- 상기 조건표는 홈 절삭 조건표이며, 실 가공시 가공 형상, 가공 목적, 적용 기계에 따라 조건변경 요망 합니다.
- 곡면 절삭시 날경의 코너R 보다 낮은 이동 PITCH를 설정 하십시오.
- 곡면 절삭시 안정적인 속도 내에서 피드를 최대30%까지 UP 해주십시오.
- 적용 기계의 회전속도가 부족한 경우에는 회전 속도와 이송 속도를 같은 비율로 줄여서 적용합니다.
- 에어브로 혹은 미스트 쿨런트를 추천하며 칩 제거 주의 및 가공시 발열, 발화에 주의 하십시오.

- Above the table is a reference for groove milling, and adjust parameters depending on material shape, milling purpose, and CNC machine.
- For curved milling, set up the pitch value lower than corner radius value.
- For curved milling, raise up the feed up to 30% in stable condition.
- If the table over the maximum RPM and feed of your machine, adjust RPM and feed in the same proportion.
- Air blow or mist coolant is recommended and note for chip emission, heat, or ignition.

# 4&6JJCRL Cutting Condition

• RPM : rev./min • Feed : mm/min

피삭재 Material	홈절삭 Slotting						측면절삭 Side Cutting					
	합금강 / 프리하든강 Alloy Steels / Prehardened Steels NAK80/KP4M		고경도강 Hardened Steels STAVAX/SKD11		열처리 / 고경도강 Heat-treated steels / Hardened Steels SKD11 / SKD61		합금강 / 프리하든강 Alloy Steels / Prehardened Steels NAK80/KP4M		고경도강 Hardened Steels STAVAX/SKD11		열처리 / 고경도강 Heat-treated steels / Hardened Steels SKD11 / SKD61	
경도 Hardness	40 ~ 45HRC		45 ~ 55HRC		55 ~ 62HRC		40 ~ 45HRC		45 ~ 55HRC		55 ~ 62HRC	
외경 Outside Diameter	RPM	FEED	RPM	FEED	RPM	FEED	RPM	FEED	RPM	FEED	RPM	FEED
∅ 1	28,000	500	25,500	300	18,500	150	30,000	500	28,000	430	24,500	300
∅ 2	14,820	700	13,500	400	9,500	200	16,500	700	14,300	600	12,500	450
∅ 3	7,800	800	6,900	400	6,000	220	11,500	1,100	10,500	860	9,500	650
∅ 4	7,150	800	6,100	450	5,750	250	9,200	1,100	7,600	900	7,100	680
∅ 5	6,500	900	5,700	510	5,100	300	7,200	1,200	6,400	950	6,000	720
∅ 6	6,100	1,000	5,150	520	4,850	320	6,200	1,300	5,300	1,040	4,950	810
∅ 8	5,800	1,100	4,810	520	4,150	330	4,800	1,400	4,100	1,120	3,900	820
∅ 10	5,500	1,200	4,200	500	3,850	310	3,700	1,300	3,000	1,030	2,600	810
∅ 12	5,100	1,100	3,950	450	3,500	290	3,000	1,200	2,700	980	2,100	780
∅ 16	4,750	1,100	3,700	430	3,200	290	2,750	1,200	2,450	980	1,950	760

0.5D  
0.05D

0.03D  
1.0D  
~ 60HRC

0.02D  
0.5D  
60HRC ~

경사진면절삭  
Inclined Cutting

- 안정적인 절삭을 위해 홈 가공시 날경의 코너R을 유의하여 ae 값을 설정 하십시오.
- 유효장이 긴 경우에는 회전수와 이송 속도를 최대 30%이하로 줄이십시오.
- HRC60 이상인 경우 같은 직경의 같은 비율로 20% DOWN 시켜주십시오.
- 상기 절삭조건은 참고 수치이므로 실 가공시 가공 형상, 가공 목적, 적용 기계에 따라 조건변경 요망 합니다.
- 조건표가 기계의 최대스핀들 속도를 초과 하거나 버 및 적열 현상이 발생할때 스펀들 속도와 이송 속도를 비례하여 조정 하십시오.
- 피삭재와 절삭형상을 위한 적절한 쿨런트 사용과 가공시 발열, 발화에 주의 하십시오.
- For stable cutting, set the ae value by paying attention to the corner radius during grooving machining.
- In case of long effective length, reduce the RPM and feed by 30% or less.
- In case the material of HRC over 60, reduce the RPM and feed by 20%.
- Use this table for your reference. Adjust the parameters depending on your machining geometry, machining purpose and CNC.
- If the table over the maximum RPM and feed of your machine, or found red heat on the material, adjust RPM and feed in the same proportion.
- Air blow or mist coolant is recommended and note for chip emission, heat, or ignition.

# 4&6JJDRC Cutting Condition

• RPM : rev./min • Feed : mm/min

피삭재 Material	고경도강 Hardened Steels STAVAX/SKD11				열처리 / 고경도강 Heat-treated steels / Hardened Steels SKD11 / SKD61				열처리 / 고경도강 Heat-treated steels / Hardened Steels YXR7 / SKH51				열처리 / 고경도강 Heat-treated steels / Hardened Steels YXR7 / SKH51				
	경도 Hardness		50 ~ 55HRC		55 ~ 62HRC		62 ~ 66HRC		66 ~ 72HRC								
외경 Outside Diameter	날수 No. of flutes	RPM	FEED	Ap Axial Depth	Ae Radial Depth	RPM	FEED	Ap Axial Depth	Ae Radial Depth	RPM	FEED	Ap Axial Depth	Ae Radial Depth	RPM	FEED	Ap Axial Depth	Ae Radial Depth
∅ 1	4	30,250	8,250	0.04	0.6	20,700	5,500	0.02	0.6	17,510	5,200	0.018	0.6	14,330	2,250	0.013	0.5
∅ 2	4	15,100	8,250	0.08	1.2	10,350	5,500	0.04	1.2	8,760	5,100	0.036	1.2	7,170	2,250	0.026	1.0
∅ 3	4	10,000	8,580	0.12	1.8	6,900	5,750	0.06	1.8	5,840	4,850	0.054	1.8	4,780	2,320	0.039	1.5
∅ 4	4	7,560	8,190	0.16	2.4	5,170	7,000	0.08	2.4	4,380	4,250	0.072	2.4	3,580	2,800	0.052	2.0
∅ 5	4	6,050	8,520	0.20	3.0	4,140	7,250	0.10	3.0	3,500	4,250	0.090	3.0	2,870	3,000	0.065	2.5
∅ 6	6	5,040	13,170	0.24	3.6	3,450	9,250	0.12	3.6	2,920	6,500	0.108	3.6	2,390	3,700	0.078	3.0
∅ 8	6	3,780	13,800	0.28	4.2	2,590	9,250	0.14	4.2	2,190	6,825	0.144	4.2	1,790	3,950	0.091	3.5
∅ 10	6	3,025	13,590	0.32	4.8	2,070	9,100	0.16	4.8	1,750	6,500	0.181	4.8	1,430	4,000	0.104	4.0
∅ 12	6	2,520	12,990	0.36	5.4	1,720	10,725	0.18	5.4	1,460	6,000	0.217	5.4	1,200	3,900	0.117	4.5

절입량  
Depth of Cut

Slotting

- Ap : Axial Depth
- D : Outside Diameter

Side Milling

- Ap : Axial Depth
- Ae : Radial Depth

- 날경 보다 낮은 이동 PITCH를 설정 하십시오. (날경 보다 클 시 경우 CUSP가 남는다)
- 윤곽 가공에 가장 적합한 제품으로, 가능한 가공성이 좋은 기계를 사용 하십시오.
- 상기 절삭조건은 참고 수치이므로 실 가공시 가공 형상, 가공 목적, 적용 기계에 따라 조건 변경 요망합니다.
- 적용 기계의 회전속도가 부족한 경우에는 회전 속도와 이송 속도를 같은 비율로 줄여서 적용합니다.
- 피삭재와 가공 모양에 따라 적절한 쿨런트를 사용 하십시오.
- Use lower value of pitch than tool diameter. If not, cusp will appear on the workpiece.
- Contouring machining method is the most recommended, and use great rigidity of CNC.
- Use this table for your reference. Adjust the parameters depending on your machining geometry, machining purpose and CNC.
- If your CNC machine cannot run enough RPM and Feed, reduce the RPM and feed in same proportion.
- Depending on the workpiece and shape, use adequate coolant.

피삭재 Material		합금강 / 프리하드강 Alloy Steels / Prehardened Steels NAK80/KP4M				고경도강 Hardened Steels STAVAX/SKD11				열처리 / 고경도강 Heat-treated steels / Hardened Steels SKD11 / SKD61			
경도 Hardness		40 ~ 45HRC				45 ~ 55HRC				55 ~ 62HRC			
외경 Outside Diameter	반경 Corner Radius	RPM	FEED	Ap Axial Depth	Ae Radial Depth	RPM	FEED	Ap Axial Depth	Ae Radial Depth	RPM	FEED	Ap Axial Depth	Ae Radial Depth
∅ 1	R 0.2	42,000	7,605	0.02	0.40	35,000	6,375	0.015	0.30	25,000	5,689	0.015	0.30
∅ 1.5	R 0.5	40,000	7,800	0.02	0.60	30,000	6,376	0.025	0.50	21,000	5,691	0.023	0.50
∅ 2	R 0.5	27,000	8,190	0.03	0.80	24,000	6,377	0.030	0.60	16,000	5,693	0.030	0.60
∅ 3	R 0.5	18,000	8,775	0.03	1.20	16,000	6,378	0.045	0.90	11,000	5,695	0.045	0.90
∅ 4	R 0.5	16,000	9,750	0.05	1.60	13,000	6,379	0.060	1.20	9,000	5,697	0.060	1.20
"	R 1.0	14,000	9,263	0.06	1.60	12,000	6,380	0.060	1.20	8,000	5,699	0.060	1.20
∅ 5	R 0.5	12,000	11,700	0.08	2.00	11,000	6,381	0.075	1.50	7,300	5,702	0.075	1.50
"	R 1.0	11,000	10,725	0.08	2.00	9,600	6,382	0.075	1.50	6,400	5,704	0.075	1.50
∅ 6	R 0.3	10,900	12,870	0.09	2.40	10,000	6,383	0.090	1.80	6,500	5,706	0.090	1.80
"	R 0.5	10,600	12,675	0.09	2.40	9,500	6,383	0.090	1.80	6,300	5,708	0.090	1.80
"	R 1.0	12,654	12,285	0.09	2.40	9,000	6,384	0.090	1.80	5,800	5,710	0.090	1.80
"	R 1.5	9,000	10,725	0.09	2.40	8,000	6,385	0.090	1.80	5,300	5,713	0.090	1.80
∅ 8	R 0.3	8,400	13,163	0.12	3.20	7,300	6,386	0.120	2.40	4,700	5,715	0.120	2.40
"	R 0.5	8,200	12,675	0.12	3.20	7,100	6,387	0.120	2.40	4,600	5,717	0.120	2.40
"	R 1.0	8,000	11,700	0.12	3.20	6,700	6,388	0.120	2.40	4,520	5,719	0.120	2.40
"	R 2.0	7,000	10,725	0.12	3.20	6,000	6,389	0.120	2.40	4,000	5,721	0.120	2.40
∅ 10	R 0.3	6,490	12,656	0.15	4.00	5,664	6,390	0.150	3.00	3,776	5,724	0.150	3.00
"	R 0.5	6,325	12,334	0.15	4.00	5,520	6,391	0.150	3.00	3,680	5,726	0.150	3.00
"	R 1.0	6,160	12,012	0.15	4.00	5,376	6,392	0.150	3.00	3,584	5,728	0.150	3.00
"	R 2.0	5,500	10,725	0.15	4.00	4,800	6,393	0.150	3.00	3,200	5,730	0.150	3.00
∅ 12	R 0.5	5,428	11,505	0.18	4.80	4,838	6,394	0.180	3.60	3,186	5,732	0.180	3.60
"	R 1.0	5,290	11,213	0.18	4.80	4,715	6,395	0.180	3.60	3,105	5,734	0.180	3.60
"	R 2.0	5,152	10,920	0.18	4.80	4,592	6,396	0.180	3.60	3,024	5,737	0.180	3.60
"	R 3.0	4,600	9,750	0.18	4.80	4,100	6,397	0.180	3.60	2,700	5,739	0.180	3.60
∅ 16	R 1.0	4,012	10,124	0.24	6.40	3,540	6,398	0.240	4.80	2,360	5,741	0.240	4.80
"	R 2.0	3,400	8,580	0.24	6.40	3,000	6,398	0.240	4.80	2,000	5,743	0.240	4.80

절입량  
Depth of Cut

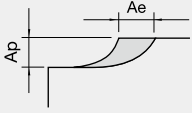

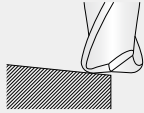

경사진면절삭  
Inclined Cutting

### ■ Coefficients respective of tool overhang

Type	Overhang	Revolution	Feed rate	Depth of Cut ap
Straight	L/D ≤ 5	100%	100%	100%
	L/D = 6	90%	80%	80%
	L/D = 7	80%	70%	70%
Taper neck	L/D = 6	100%	100%	100%
	L/D = 8	90%	80%	80%
	L/D ≥ 10	80%	70%	70%

- 곡면 절삭시 날경의 코너R 보다 낮은 이동 PITCH를 설정 하십시오.
- 상기 조건표는 4날 기준입니다.
- 날수에 따라 회전수는 유지하고, 피드는 안정적인 속도 내에서 최대 50%까지 UP 해주십시오.
- 상기 절삭조건은 참고 수치이므로 실 가공시 가공 형상, 가공 목적, 적용기계에 따라 조건 변경 요망 합니다.
- 적용 기계의 회전 속도가 부족한 경우에는 회전 속도와 이송 속도를 같은 비율로 줄여 주십시오.
- 유효장 길이가 긴 경우, 위 표와같이 RPM과 FEED를 낮춰주세요.
- 절입 깊이가 얇은 경우, RPM과 FEED를 증가해 주세요.
- 원활한 칩배출을 위하여 에어브로우나 오일 미스트를 추천 합니다.
- For curved milling, raise up the feed up to 30% in stable condition.
- The parameters on the table are based on 4 flutes.
- With 6 flutes milling, raise up the feed up to 50% in stable condition.
- Use this table for your reference. Adjust the parameters depending on your machining geometry, machining purpose and CNC.
- If your CNC machine cannot run enough RPM and Feed, reduce the RPM and feed in same proportion.
- In case of long effective length, reduce the RPM and feed by 30% or less.
- If you use small value of Ap, raise up the RPM and feed.
- Air blow or oil mist is recommended for smooth chip emission.

## 홈절삭 Slotting

피삭재 Material	공구강 / 금형강 Tool steels / Mold steels				합금강 / 프리하든강 Alloy Steels / Pre-hardened Steels				스테인레스강 Stainless Steels				스테인레스강 Stainless Steels			
경도 Hardness	SCM / HPM 30 ~40Hrc				NAK80 / KP4M 40~45Hrc				SUS304 / SUS316				SUS630 / SUS631			
외경 Outside Diameter	RPM	FEED	Ap Axial Depth	Ae Radial Depth	RPM	FEED	Ap Axial Depth	Ae Radial Depth	RPM	FEED	Ap Axial Depth	Ae Radial Depth	RPM	FEED	Ap Axial Depth	Ae Radial Depth
ø 6	5,940	970	0.3	6.0	4,950	500	0.3	6.0	4,050	390	0.12	6.0	3,105	280	0.12	6.0
ø 8	4,410	1,110	0.4	8.0	3,762	620	0.4	8.0	3,042	495	0.16	8.0	2,322	315	0.16	8.0
ø 10	3,582	1,025	0.5	10.0	2,970	620	0.5	10.0	2,430	460	0.20	10.0	1,863	300	0.20	10.0
ø 12	2,979	1,000	0.6	12.0	2,502	520	0.6	12.0	2,025	460	0.24	12.0	1,548	300	0.24	12.0
ø 16	2,250	835	0.8	16.0	1,881	430	0.8	16.0	1,521	325	0.32	16.0	1,170	260	0.32	16.0
ø 20	1,791	720	1.0	20.0	1,503	400	1.0	20.0	1,215	325	0.40	20.0	927	225	0.40	20.0

일반강 General Steel

SUS

## 측면절삭 Side Cutting

피삭재 Material	공구강 / 금형강 Tool steels / Mold steels				합금강 / 프리하든강 Alloy Steels / Pre-hardened Steels				스테인레스강 Stainless Steels				스테인레스강 Stainless Steels			
경도 Hardness	SCM / HPM 30 ~40Hrc				NAK80 / KP4M 40~45Hrc				SUS304 / SUS316				SUS630 / SUS631			
외경 Outside Diameter	RPM	FEED	Ap Axial Depth	Ae Radial Depth	RPM	FEED	Ap Axial Depth	Ae Radial Depth	RPM	FEED	Ap Axial Depth	Ae Radial Depth	RPM	FEED	Ap Axial Depth	Ae Radial Depth
ø 6	6,600	745	6	0.18	5,500	450	6	0.18	4,500	300	3	0.12	3,450	250	3	0.1
ø 8	4,900	850	8	0.25	4,180	550	8	0.25	3,380	380	4	0.16	2,580	280	4	0.2
ø 10	3,980	785	10	0.3	3,300	550	10	0.3	2,700	350	5	0.2	2,070	260	5	0.2
ø 12	3,310	765	12	0.36	2,780	460	12	0.36	2,250	350	6	0.24	1,720	270	6	0.2
ø 16	1,990	640	16	0.48	2,090	380	16	0.48	1,690	250	8	0.32	1,300	230	8	0.3
ø 20	2,500	550	20	0.6	1,670	350	20	0.6	1,350	250	10	0.4	1,030	200	10	0.4

일반강 General Steel

SUS

- 가능한 공구 길이 측정시 유압식 측정이 아닌 레이저식 도구 세터를 사용 하십시오.
- 가공 진입시 가능한 피삭재 밖에서 진입 하십시오.
- 상기 절삭조건은 참고 수치이므로 실 가공시 가공 형상, 가공 목적, 적용 기계에 따라 조건변경 요망 합니다.
- 공작기계와 가공물의 강성이 없는 경우 진동이 발생할 시 조건표에 회전속도와 이송 속도를 같은 비율로 줄여서 적용 합니다.
- 피삭재와 가공 모양에 따라 적절한 쿨런트를 사용 하십시오.
- 스테인레스, 내열합금강 등의 절단 가공 시 수용성 절삭유가 가장 효과적 입니다.
- Use laser tool measurement instead of hydraulic measurement when measuring tool length as possible.
- When entering the tool to the workpiece, enter the tool from outside to the workpiece.
- Use this table for your reference. Adjust the parameters depending on your machining geometry, machining purpose and CNC.
- In case of workpiece and machine do not have enough rigidity and make vibration, reduce the RPM and feed in same proportion.
- Depending on the workpiece and shape, use adequate coolant.
- For stainless and heat resistant alloy, water-soluble oil is the most effective.

피삭재 Material		동 Copper C1100				합금강 / 프리하든강 Alloy Steels / Prehardened Steels NAK80/KP4M				고경도강 Hardened Steels STAVAX/SKD11				열처리 / 고경도강 Heat-treated steels / Hardened Steels SKD11 / SKD61			
경도 Hardness		40 ~ 45HRc								45 ~ 55HRc				55 ~ 62HRc			
반경 Radius	유효장 Effective Length	RPM	FEED	Ap Axial Depth	Ae Radial Depth	RPM	FEED	Ap Axial Depth	Ae Radial Depth	RPM	FEED	Ap Axial Depth	Ae Radial Depth	RPM	FEED	Ap Axial Depth	Ae Radial Depth
R0.05	0.3	50,000	85	0.004	0.004	45,000	70	0.004	0.004	45,000	50	0.002	0.002	45,000	40	0.002	0.002
"	0.5	50,000	75	0.004	0.004	45,000	60	0.002	0.002	45,000	30	0.002	0.002	45,000	30	0.002	0.002
R0.1	0.5	50,000	492	0.010	0.010	45,000	396	0.006	0.007	45,000	260	0.006	0.006	45,000	220	0.005	0.006
"	1	50,000	432	0.007	0.008	45,000	372	0.004	0.005	45,000	276	0.004	0.004	45,000	200	0.004	0.004
"	1.5	50,000	360	0.006	0.006	42,000	276	0.003	0.004	42,000	216	0.003	0.004	42,000	180	0.003	0.003
R0.15	1	50,000	744	0.012	0.013	45,000	552	0.010	0.010	38,000	420	0.009	0.010	38,000	348	0.007	0.009
"	3	48,000	528	0.008	0.009	40,800	360	0.006	0.007	33,600	264	0.005	0.005	33,600	216	0.004	0.005
"	5	39,600	336	0.004	0.005	28,800	216	0.003	0.003	24,000	168	0.003	0.003	21,600	120	0.002	0.002
R0.2	1	61,200	1,020	0.021	0.034	54,000	768	0.016	0.022	39,600	516	0.013	0.022	39,600	432	0.011	0.021
"	3	55,200	768	0.015	0.016	44,400	480	0.010	0.010	32,400	312	0.009	0.010	32,400	264	0.008	0.010
"	5	39,600	468	0.008	0.016	30,000	372	0.008	0.010	26,400	288	0.006	0.010	26,400	228	0.004	0.005
R0.25	1	63,600	1,560	0.026	0.047	45,600	960	0.020	0.033	33,600	636	0.014	0.032	33,600	312	0.007	0.020
"	5	52,800	1,032	0.012	0.014	34,800	552	0.008	0.008	31,200	444	0.007	0.010	31,200	216	0.006	0.009
"	10	38,400	528	0.008	0.016	28,800	456	0.007	0.010	28,800	372	0.005	0.010	27,600	216	0.005	0.009
R0.3	1	63,600	1,956	0.030	0.140	39,600	960	0.022	0.091	27,600	600	0.019	0.091	26,400	516	0.014	0.091
"	5	50,400	1,104	0.014	0.068	28,800	504	0.012	0.043	26,400	396	0.008	0.042	26,400	336	0.007	0.040
"	10	31,200	540	0.006	0.032	24,000	360	0.005	0.020	22,800	312	0.004	0.020	22,800	240	0.003	0.018
R0.4	2	61,200	2,280	0.054	0.160	34,800	816	0.045	0.100	27,600	552	0.038	0.100	26,400	456	0.030	0.100
"	6	51,600	1,452	0.035	0.100	28,800	636	0.028	0.068	21,600	420	0.020	0.068	21,600	348	0.015	0.065
"	10	31,000	630	0.022	0.080	23,400	468	0.020	0.050	17,300	408	0.015	0.050	16,800	336	0.010	0.050
R0.5	2	50,400	2,160	0.068	0.320	33,600	900	0.052	0.220	21,600	540	0.040	0.220	18,000	540	0.008	0.140
"	5	50,400	2,160	0.068	0.320	33,600	900	0.052	0.220	21,600	540	0.040	0.220	18,000	540	0.008	0.140
"	10	30,000	1,164	0.024	0.086	16,320	600	0.020	0.056	15,000	456	0.014	0.056	13,680	312	0.008	0.050
"	16	17,640	720	0.018	0.086	13,680	480	0.016	0.056	12,360	384	0.012	0.056	11,520	252	0.005	0.030
R0.75	3	31,200	2,400	0.167	0.320	21,600	1,152	0.120	0.210	12,960	672	0.100	0.210	12,000	600	0.090	0.210
"	10	26,400	1,680	0.100	0.220	14,760	780	0.080	0.170	9,720	480	0.062	0.170	9,720	456	0.050	0.160
"	18	12,120	624	0.030	0.160	12,120	504	0.022	0.110	9,600	432	0.020	0.110	9,600	408	0.012	0.110
"	30	9,840	516	0.014	0.080	9,840	456	0.012	0.050	9,480	420	0.010	0.050	9,480	396	0.010	0.050
R1	4	26,400	2,448	0.220	0.520	21,000	1,392	0.180	0.350	14,640	1,080	0.140	0.350	14,640	900	0.120	0.350
"	10	26,400	2,256	0.180	0.350	21,000	1,224	0.140	0.230	14,640	972	0.110	0.230	14,640	792	0.090	0.230
"	20	15,960	1,164	0.090	0.165	15,960	600	0.060	0.110	12,720	600	0.055	0.110	12,720	492	0.035	0.110
"	30	10,200	636	0.025	0.070	10,200	480	0.020	0.050	10,200	480	0.015	0.050	10,200	384	0.015	0.045
R1.5	6	16,800	3,240	0.250	0.500	14,400	1,824	0.200	0.340	9,840	1,320	0.160	0.320	6,480	732	0.160	0.320
"	10	16,800	3,240	0.250	0.500	14,400	1,824	0.200	0.340	9,840	1,320	0.160	0.320	6,480	732	0.160	0.300
"	20	14,040	2,244	0.200	0.450	12,360	1,476	0.145	0.320	8,520	1,128	0.120	0.310	5,760	660	0.080	0.300
"	30	10,920	1,620	0.120	0.220	9,360	816	0.100	0.150	8,520	816	0.080	0.150	5,760	384	0.070	0.300
R2	8	12,600	3,012	0.350	0.850	10,440	1,752	0.290	0.550	7,200	1,332	0.220	0.500	7,200	1,056	0.150	0.500
"	20	12,600	3,012	0.350	0.850	10,440	1,752	0.290	0.550	7,200	1,332	0.220	0.500	7,200	1,056	0.150	0.500
"	30	11,160	2,040	0.250	0.500	8,880	1,380	0.200	0.320	6,600	1,056	0.150	0.300	6,600	816	0.130	0.300
"	40	8,160	1,464	0.150	0.500	7,200	1,056	0.132	0.320	6,600	1,056	0.100	0.300	6,600	816	0.090	0.300
R2.5	15	10,800	2,880	0.380	0.800	8,400	1,500	0.300	0.700	6,000	1,140	0.220	0.700	6,000	900	0.200	0.650
"	25	10,800	2,400	0.380	0.800	8,400	1,380	0.300	0.550	6,000	1,080	0.220	0.550	6,000	816	0.200	0.500
"	40	9,360	1,320	0.250	0.800	6,720	840	0.200	0.550	4,920	660	0.150	0.550	4,920	504	0.130	0.500
R3	15	8,400	2,676	0.500	1.000	8,160	1,764	0.420	0.800	5,760	1,320	0.300	0.800	4,440	864	0.300	0.800
"	30	8,400	1,812	0.380	0.900	7,200	1,680	0.300	0.650	5,040	1,176	0.220	0.650	4,440	792	0.220	0.600
R4	25	8,160	1,764	0.410	1.000	7,200	1,176	0.350	0.750	4,920	912	0.180	0.600	4,560	732	0.200	0.630
"	30	7,680	1,680	0.380	1.000	6,960	1,128	0.300	0.750	4,800	864	0.160	0.600	4,320	720	0.200	0.600
R5	30	6,240	1,344	0.560	1.200	5,880	1,128	0.370	0.900	4,800	852	0.200	0.670	4,200	708	0.200	0.650
"	35	6,000	1,296	0.500	1.000	5,400	1,080	0.350	0.850	4,560	816	0.150	0.600	3,840	648	0.200	0.600
R6	30	5,160	1,104	0.650	1.400	4,800	984	0.420	0.900	4,320	828	0.250	0.600	3,600	600	0.250	0.600
"	40	4,920	1,080	0.600	1.200	4,560	960	0.400	0.850	4,080	780	0.200	0.600	3,600	600	0.200	0.600

절입량  
Depth of Cut

- Ap : Axial Depth
- Ae : Radial Depth
- D : Outside Diameter
- n : Speed
- Vf : Feed

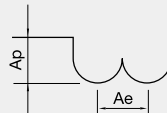

- 유효장 길이가 긴 경우, RPM과 FEED를 동일 비율로 낮춰주세요.
- 상기 절삭조건은 참고 수치이므로 실 가공시 가공 형상, 가공 목적, 적용 기계에 따라 조건 변경 요망합니다.
- 적용 기계의 회전 속도가 부족한 경우에는 회전 속도와 이송 속도를 같은 비율로 줄여서 적용 합니다.
- 진동이 적고 강성이 좋은 공작기계 사용 요망 합니다.(Ø1이하 사용시 진동 허용 관리 5µm이내 일것.)
- 원활한 칩배출을 위하여 에어브로 혹은 미스트 콜러트 사용을 추천하며, 동 가공시 습식 콜러트를 추천 합니다.
- If the effective length is long, reduce the RPM and feed in the same proportion.
- Use this table for your reference. Adjust the parameters depending on your machining geometry, machining purpose and CNC.
- If the table over the maximum RPM and feed of your machine, adjust RPM and feed in the same proportion.
- Use a machine with low vibration and good rigidity (Ø1 or less, the vibration tolerance management should be within 5µm).
- Air blow or oil mist is recommended for smooth chip emission, and wet coolant milling is recommended for copper material.

# 2PHCB/2HSB/2HCB Cutting Condition

• RPM : rev./min • Feed : mm/min

피삭재 Material		동 Copper C1100		합금강 / 프리하드강 Alloy Steels / Prehardened Steels NAK80/KP4M				고경도강 Hardened Steels STAVAX/SKD11				열처리 / 고경도강 Heat-treated steels / Hardened Steels SKD11 / SKD61					
경도 Hardness		40 ~ 45HRC								45 ~ 55HRC				55 ~ 62HRC			
반경 Radius	날장 Cutting Length	RPM	FEED	Ap Axial Depth	Ae Radial Depth	RPM	FEED	Ap Axial Depth	Ae Radial Depth	RPM	FEED	Ap Axial Depth	Ae Radial Depth	RPM	FEED	Ap Axial Depth	Ae Radial Depth
R0.05	0.2	40,000	300	0.005	0.040	40,000	300	0.004	0.004	30,000	200	0.004	0.040	Cutting is not possible.			
R0.1	0.2	54,000	430	0.020	0.060	54,000	630	0.016	0.012	44,300	450	0.023	0.008	30,000	300	0.012	0.008
"	0.4	54,000	430	0.020	0.051	54,000	430	0.016	0.040	44,300	345	0.010	0.023	32,800	260	0.007	0.008
R0.15	0.3	54,000	720	0.030	0.090	54,000	750	0.024	0.072	44,300	600	0.015	0.042	32,800	450	0.020	0.013
"	0.6	54,000	720	0.030	0.075	54,000	715	0.024	0.060	44,300	575	0.015	0.035	32,800	430	0.012	0.013
R0.2	0.4	54,000	870	0.040	0.120	54,000	1,000	0.032	0.096	44,300	800	0.020	0.056	32,800	600	0.028	0.016
"	0.8	54,000	870	0.040	0.105	54,000	880	0.032	0.084	44,300	700	0.020	0.049	32,800	525	0.016	0.016
R0.25	0.5	56,000	1,250	0.050	0.150	53,000	1,250	0.040	0.120	43,500	1,000	0.025	0.070	32,200	750	0.035	0.022
"	1	56,000	1,380	0.050	0.125	50,000	1,000	0.040	0.100	41,350	800	0.025	0.058	30,600	600	0.021	0.022
R0.3	0.6	58,000	1,510	0.060	0.180	52,000	1,380	0.048	0.144	42,650	1,100	0.030	0.084	31,500	825	0.042	0.026
"	1.2	58,000	1,710	0.060	0.155	48,500	1,020	0.048	0.124	40,500	810	0.030	0.072	30,000	610	0.025	0.026
R0.4	0.8	52,000	1,870	0.080	0.240	48,000	1,500	0.064	0.192	39,500	1,200	0.040	0.112	29,250	900	0.056	0.036
"	2	52,000	1,970	0.080	0.200	45,000	1,085	0.064	0.160	37,500	870	0.040	0.093	27,800	650	0.033	0.036
R0.5	1	41,000	1,660	0.100	0.300	38,540	1,560	0.080	0.240	36,900	1,250	0.050	0.140	27,300	940	0.063	0.040
"	2.5	41,000	1,880	0.100	0.200	38,540	1,000	0.080	0.160	31,500	800	0.050	0.090	23,000	600	0.022	0.040
R0.6	3	34,000	2,120	0.120	0.360	31,960	1,550	0.096	0.288	32,800	1,250	0.060	0.168	24,400	940	0.072	0.051
R0.75	1.5	27,000	2,280	0.150	0.450	25,380	1,600	0.120	0.360	28,700	1,280	0.075	0.210	21,500	960	0.087	0.068
"	4	27,000	1,830	0.150	0.325	25,380	1,000	0.120	0.260	26,000	800	0.075	0.152	19,250	600	0.052	0.068
R1	2	32,700	3,560	0.200	0.600	30,738	1,850	0.160	0.480	24,600	1,480	0.100	0.280	18,250	1,110	0.112	0.089
"	5	32,700	2,980	0.200	0.435	30,738	1,350	0.160	0.348	22,000	1,080	0.100	0.203	16,250	810	0.067	0.089
R1.25	6	30,600	3,680	0.250	0.542	28,764	1,600	0.200	0.430	27,901	1,280	0.125	0.251	15,500	960	0.067	0.115
R1.5	3	26,100	4,400	0.300	0.957	24,534	2,520	0.240	0.766	23,798	2,050	0.150	0.447	15,500	1,530	0.197	0.171
"	8	26,100	4,110	0.300	0.765	24,534	2,350	0.240	0.612	23,798	1,880	0.150	0.357	15,500	1,410	0.100	0.171
R2	4	18,800	4,160	0.400	1.380	17,672	2,450	0.320	1.100	17,142	1,960	0.200	0.644	12,800	1,470	0.266	0.208
"	8	18,800	3,920	0.400	1.020	17,672	2,350	0.320	0.816	17,142	1,880	0.200	0.476	12,800	1,410	0.134	0.208
R2.5	5	17,300	3,980	0.500	1.660	16,262	2,560	0.400	1.330	15,774	2,050	0.250	0.770	11,000	1,530	0.215	0.240
"	10	17,300	3,660	0.500	1.275	16,262	2,300	0.400	1.020	15,774	1,840	0.250	0.595	11,000	1,380	0.180	0.240
R3	6	16,500	3,880	0.600	2.340	15,510	2,700	0.480	1.870	15,045	2,160	0.300	1.090	9,600	1,620	0.290	0.281
"	12	16,500	3,500	0.600	1.530	15,510	2,400	0.480	1.225	15,045	1,920	0.300	0.715	9,600	1,440	0.230	0.281
R4	8	11,660	4,000	0.800	3.100	10,960	2,300	0.640	2.480	10,632	1,840	0.400	1.446	7,600	1,380	0.400	0.175
"	14	11,660	3,850	0.800	2.050	10,960	2,000	0.640	1.640	10,632	1,600	0.400	0.957	7,600	1,200	0.400	0.175
R5	10	9,560	4,100	1.000	3.750	8,986	2,200	0.800	3.000	8,717	1,780	0.500	1.750	6,400	1,340	0.500	0.154
"	18	9,560	3,720	1.000	2.550	8,986	1,700	0.800	2.040	8,717	1,360	0.500	1.190	6,400	1,020	0.500	0.154
R6	12	7,100	4,000	1.200	4.420	6,674	1,850	0.960	3.540	6,474	1,480	0.600	2.060	5,450	1,110	0.600	0.159
"	22	7,100	3,250	1.200	3.050	6,674	1,600	0.960	2,440	6,474	1,280	0.600	1.423	5,450	960	0.600	0.159
R8	30	4,650	2,000	1.120	3.870	4,371	1,630	0.790	2,350	4,240	1,100	0.500	1.742	4,000	810	0.450	1.150
R10	38	3,200	2,200	1.100	4.120	3,008	1,450	0.840	2,530	2,918	1,100	0.520	1.866	3,100	800	0.400	1.000

**절입량**  
Depth of Cut

- Ap : Axial Depth
- Ae : Radial Depth
- D : Outside Diameter
- n : Speed
- Vf : Feed

- 유효장 길이가 긴 경우, RPM과 FEED를 동일 비율로 낮춰주세요.
- 상기 절삭조건은 참고 수치이므로 실 가공시 가공 형상, 가공 목적, 적용 기계에 따라 조건 변경 요망합니다.
- 적용 기계의 회전 속도가 부족한 경우에는 회전 속도와 이송 속도를 같은 비율로 줄여서 적용 합니다.
- 진동이 적고 강성이 좋은 공작기계 사용 요망 합니다.( $\phi 1$ 이하 사용시 진동 허용 관리 5 $\mu$ m이내 일것.)
- 원활한 칩배출을 위하여 에어브로 혹은 미스트 콜러트 사용을 추천하며, 동 가공시 습식 콜러트를 추천 합니다.
- If the effective length is long, reduce the RPM and feed in the same proportion.
- Use this table for your reference. Adjust the parameters depending on your machining geometry, machining purpose and CNC.
- If the table over the maximum RPM and feed of your machine, adjust RPM and feed in the same proportion.
- Use a machine with low vibration and good rigidity ( $\phi 1$  or less, the vibration tolerance management should be within 5 $\mu$ m).
- Air blow or oil mist is recommended for smooth chip emission, and wet coolant milling is recommended for copper material.

# 3HCB/4HSB/4HCB

- 3HCB는 RPM 동일, FEED만 최대 20% Down 적용.
- Use the same RPM, reduce the feed rate up to 20% for 3HCB

피삭재 Material	동 Copper C1100				합금강 / 프리하든강 Alloy Steels / Prehardened Steels NAK80/KP4M				고경도강 Hardened Steels STAVAX/SKD11				열처리 / 고경도강 Heat-treated steels / Hardened Steels SKD11 / SKD61			
경도 Hardness					40 ~ 45HRc				45 ~ 55HRc				55 ~ 62HRc			
반경 Radius	RPM	FEED	Ap Axial Depth	Ae Radial Depth	RPM	FEED	Ap Axial Depth	Ae Radial Depth	RPM	FEED	Ap Axial Depth	Ae Radial Depth	RPM	FEED	Ap Axial Depth	Ae Radial Depth
R 0.5	41,000	1990	0.100	0.300	38,540	1870	0.080	0.240	36,900	1500	0.050	0.140	27,300	1120	0.040	0.063
R 0.75	27,000	2740	0.150	0.450	25,380	1920	0.120	0.360	28,700	1530	0.075	0.210	21,500	1150	0.068	0.087
R 1	32,700	4200	0.200	0.600	30,738	2220	0.160	0.480	24,600	1770	0.100	0.280	18,250	1330	0.089	0.112
R 1.25	30,600	4400	0.250	0.542	28,764	1920	0.200	0.430	27,901	1540	0.125	0.251	15,500	1150	0.115	0.167
R 1.5	26,100	5280	0.300	0.957	24,534	3020	0.240	0.766	23,798	1820	0.150	0.447	15,500	1840	0.171	0.197
R 2	18,800	4990	0.400	1.380	17,672	2940	0.320	1.100	17,142	1850	0.200	0.644	12,800	1760	0.208	0.215
R 2.5	17,300	4770	0.500	1.660	16,262	3070	0.400	1.330	15,774	1870	0.250	0.770	11,000	1800	0.240	0.266
R 3	16,500	4650	0.600	2.340	15,510	3240	0.480	1.870	15,045	1900	0.300	1.090	9,600	2000	0.281	0.290
R 4	11,660	4800	0.800	3.100	10,960	2760	0.640	2.480	10,632	1820	0.400	1.446	7,600	1650	0.175	0.400
R 5	9,560	4920	1.000	3.750	8,986	2640	0.800	3.000	8,717	1850	0.500	1.750	6,400	1600	0.154	0.500
R 6	7,100	4800	1.200	4.420	6,674	2220	0.960	3.540	6,474	1770	0.600	2.060	5,450	1650	0.159	0.600
R 8	4,650	3900	1.400	4.420	4,371	1950	0.960	3.540	4,240	1760	0.600	2.060	4,000	1670	0.250	1.150
R 10	3,200	3950	1.600	4.420	3,008	1740	0.960	3.540	2,918	1750	0.600	2.060	3,100	1680	0.300	1.000

**절입량**  
Depth of Cut

- Ap : Axial Depth
- Ae : Radial Depth
- D : Outside Diameter
- n : Speed
- Vf : Feed

- 유효장 길이가 긴 경우, RPM과 FEED를 동일 비율로 낮춰 주세요.
- 상기 조건표는 4날 기준이며, 3날시 회전수는 유지하고, 피드는 안정적인 속도내로 최대 20%까지 DOWN 해주십시오. (3HCB)
- 상기 절삭조건은 참고 수치이므로 실 가공시 가공 형상, 가공 목적, 적용 기계에 따라 조건 변경 요망합니다.
- 적용 기계의 회전 속도가 부족한 경우에는 회전 속도와 이송 속도를 같은 비율로 줄여서 적용 합니다.
- 진동이 적고 강성이 좋은 공작기계 사용 요망 합니다.( $\phi 10$ 이하 사용시 진동 허용 관리  $5\mu$ 이내 일것.)
- 원활한 칩 배출을 위하여 에어브로 혹은 미스트 콜러트 사용을 추천하며, 동 가공시 습식 콜러트를 추천 합니다.
- If the effective length is long, reduce the RPM and feed in the same proportion.
- The parameters on the table is based on 4flutes. For using 3 flutes (3HCB), use the same RPM and reduce the feed maximum 20% in stable milling condition.
- Use this table for your reference. Adjust the parameters depending on your machining geometry, machining purpose and CNC.
- If the table over the maximum RPM and feed of your machine, adjust RPM and feed in the same proportion.
- Use a machine with low vibration and good rigidity ( $\phi 1$  or less, the vibration tolerance management should be within  $5\mu$ ).
- Air blow or oil mist is recommended for smooth chip emission, and wet coolant milling is recommended for copper material.



피삭재 Material		구조용강 / 탄소강 / 회주철 Mild steels / Carbon Steels / Gray cast irons SS / SC / FC				공구강 / 금형강 Tool steels / Mold steels SCM / HPM				합금강 / 프리하든강 Alloy Steels / Pre-hardened Steels NAK80 / KP4M				고경도강 Hardened Steels STAVAX / SKD11			
경도 Hardness		~30HRc				30 ~ 40HRc				40 ~ 45HRc				45 ~ 55HRc			
외경 Outside Diameter	유효장 Effective Length	RPM	FEED	Ap Axial Depth	Ae Radial Depth	RPM	FEED	Ap Axial Depth	Ae Radial Depth	RPM	FEED	Ap Axial Depth	Ae Radial Depth	RPM	FEED	Ap Axial Depth	Ae Radial Depth
ø 0.2	0.5	56,000	340	0.006	0.002	56,000	310	0.005	0.002	56,000	270	0.003	0.016	44,800	180	0.002	0.0118
"	1	50,900	290	0.005	0.016	50,900	260	0.005	0.016	50,900	230	0.004	0.02	40,800	160	0.003	0.0144
"	1.5	48,200	250	0.003	0.006	48,200	230	0.003	0.006	48,200	200	0.002	0.006	38,500	140	0.002	0.0054
ø 0.3	1	60,000	560	0.009	0.101	60,000	500	0.008	0.101	60,000	400	0.006	0.101	52,100	330	0.004	0.0909
"	1.5	50,800	460	0.008	0.057	50,800	410	0.007	0.057	50,800	360	0.005	0.057	42,700	260	0.004	0.0513
"	2	41,500	350	0.006	0.013	41,500	320	0.005	0.013	41,500	280	0.004	0.013	33,200	190	0.003	0.0117
"	3	31,900	240	0.002	0.004	31,900	220	0.002	0.004	31,900	190	0.001	0.004	25,500	130	0.001	0.0036
"	4	26,200	170	0.001	0.003	26,200	160	0.001	0.003	26,200	140	0.001	0.003	20,900	100	0.001	0.0027
"	5	20,400	100	0.001	0.002	20,400	90	0.001	0.002	20,400	80	0.001	0.002	16,300	60	0.001	0.0018
ø 0.4	1	52,700	660	0.012	0.054	57,700	640	0.010	0.054	48,100	470	0.008	0.054	38,500	320	0.005	0.0486
"	5	38,500	380	0.003	0.003	34,200	300	0.003	0.003	30,100	240	0.002	0.003	24,100	160	0.001	0.0027
"	10	33,700	260	0.001	0.001	27,300	190	0.001	0.001	24,600	150	0.001	0.001	19,700	100	0.001	0.0009
ø 0.5	2	56,800	900	0.020	0.098	54,000	760	0.016	0.098	40,600	510	0.014	0.098	32,500	350	0.010	0.0882
"	3	44,200	660	0.016	0.016	39,900	530	0.016	0.016	32,200	370	0.008	0.016	25,700	260	0.006	0.0144
"	4	40,600	580	0.009	0.012	36,100	460	0.008	0.012	29,700	330	0.008	0.012	23,700	230	0.005	0.0108
"	5	37,000	500	0.008	0.008	32,300	390	0.008	0.008	27,200	290	0.006	0.008	21,700	200	0.004	0.0072
"	6	33,400	420	0.005	0.004	28,500	320	0.005	0.004	24,700	250	0.003	0.004	19,700	170	0.002	0.0036
"	8	29,100	320	0.002	0.002	24,100	240	0.002	0.002	21,600	190	0.001	0.002	17,400	130	0.001	0.0018
"	10	26,100	250	0.001	0.001	21,200	180	0.001	0.001	19,600	150	0.001	0.001	15,600	100	0.001	0.0009
"	14	21,500	120	0.001	0.001	16,700	80	0.001	0.001	16,300	70	0.001	0.001	13,000	50	0.001	0.0009
ø 0.6	2	63,600	1,240	0.025	0.203	53,300	930	0.020	0.203	39,100	600	0.016	0.203	31,300	410	0.011	0.1827
"	3	52,500	990	0.018	0.114	44,000	740	0.016	0.114	33,500	500	0.013	0.114	26,800	340	0.009	0.1026
"	4	41,300	740	0.012	0.025	34,700	550	0.011	0.025	27,900	390	0.009	0.025	22,300	270	0.006	0.0225
"	5	36,700	630	0.010	0.017	30,900	470	0.009	0.017	25,500	340	0.007	0.017	20,400	240	0.005	0.0153
"	6	32,100	520	0.007	0.008	27,000	390	0.006	0.008	23,000	290	0.005	0.008	18,400	200	0.003	0.0072
"	8	26,800	390	0.004	0.003	22,600	300	0.004	0.003	20,000	230	0.003	0.003	16,000	160	0.002	0.0027
"	10	23,400	300	0.002	0.002	19,700	230	0.002	0.002	17,900	180	0.002	0.002	14,300	130	0.001	0.0018
"	12	20,900	240	0.002	0.001	17,600	180	0.001	0.001	16,400	150	0.001	0.001	13,100	100	0.001	0.0009
"	16	16,200	100	0.001	0.001	13,700	80	0.001	0.001	13,500	70	0.001	0.001	10,800	50	0.001	0.0009
ø 0.7	2	59,800	1,380	0.030	0.047	50,200	1,040	0.027	0.047	36,100	660	0.021	0.047	28,800	430	0.015	0.0423
"	4	38,900	840	0.017	0.038	32,700	630	0.015	0.038	25,800	440	0.012	0.038	20,600	290	0.009	0.0342
"	6	30,200	600	0.010	0.014	25,400	450	0.009	0.014	21,200	330	0.007	0.014	16,900	230	0.005	0.0126
"	8	25,300	460	0.006	0.006	21,300	350	0.005	0.006	18,400	260	0.004	0.006	14,700	190	0.003	0.0054
"	10	22,000	360	0.004	0.003	18,500	270	0.003	0.003	16,500	220	0.003	0.003	13,200	160	0.002	0.0027
ø 0.8	2	41,200	1,050	0.033	0.108	34,500	460	0.029	0.108	26,200	530	0.023	0.108	21,000	370	0.016	0.0972
"	4	37,100	930	0.027	0.08	31,100	700	0.024	0.08	24,100	480	0.019	0.08	19,300	330	0.013	0.072
"	6	28,800	680	0.015	0.024	24,200	510	0.013	0.024	19,800	370	0.010	0.024	15,800	250	0.007	0.0216
"	8	24,100	520	0.009	0.01	20,300	390	0.008	0.01	17,200	300	0.006	0.01	13,800	200	0.004	0.009
"	10	21,000	420	0.006	0.005	17,700	320	0.005	0.005	15,500	240	0.004	0.005	12,400	170	0.003	0.0045
"	12	18,700	340	0.004	0.003	15,800	260	0.003	0.003	14,100	200	0.003	0.003	11,300	140	0.002	0.0027
"	14	15,600	230	0.002	0.001	13,200	180	0.002	0.001	12,300	150	0.001	0.001	980	100	0.001	0.0009
ø 0.9	6	27,600	790	0.019	0.019	23,000	590	0.017	0.019	18,500	420	0.013	0.019	14,800	290	0.010	0.0171
"	8	23,000	600	0.012	0.012	19,300	450	0.011	0.012	16,100	330	0.008	0.012	12,900	230	0.006	0.0108
"	10	20,000	470	0.008	0.008	16,800	360	0.007	0.008	14,500	270	0.005	0.008	11,600	190	0.004	0.0072
ø 1.0	2	37,900	1,340	0.048	0.263	31,500	990	0.043	0.263	23,400	6,500	0.034	0.263	18,700	440	0.031	0.237
"	3	37,900	1,340	0.048	0.263	31,500	990	0.043	0.263	23,400	6,500	0.034	0.263	18,700	440	0.031	0.237
"	4	34,100	1,170	0.040	0.195	28,400	870	0.036	0.195	21,500	580	0.028	0.195	17,200	400	0.025	0.176
"	5	30,300	1,000	0.032	0.058	25,300	750	0.029	0.058	19,600	510	0.022	0.058	15,700	360	0.020	0.052
"	6	26,500	850	0.023	0.024	22,100	630	0.021	0.024	17,600	440	0.016	0.024	14,100	310	0.014	0.022
"	8	22,100	660	0.014	0.013	18,600	490	0.013	0.013	15,300	360	0.010	0.013	12,300	250	0.009	0.012
"	10	19,200	530	0.010	0.013	16,200	400	0.009	0.013	13,800	300	0.007	0.013	11,000	210	0.006	0.012
"	12	17,200	440	0.007	0.007	14,500	330	0.006	0.007	12,600	250	0.005	0.007	10,100	170	0.005	0.006
"	14	15,600	360	0.005	0.005	13,200	270	0.004	0.005	11,700	210	0.003	0.005	9,400	150	0.003	0.005
"	16	14,300	300	0.004	0.003	12,100	230	0.003	0.003	11,000	180	0.003	0.003	8,800	130	0.003	0.003
"	20	12,500	200	0.003	0.001	10,600	160	0.003	0.001	9,800	130	0.002	0.001	7,900	90	0.002	0.001
"	25	10,800	120	0.003	0.001	9,200	90	0.002	0.001	8,800	80	0.002	0.001	7,100	50	0.002	0.001
"	30	9,700	50	0.002	0.001	8,200	40	0.002	0.001	8,100	30	0.001	0.001	6,500	30	0.001	0.0009
ø 1.2	4	28,900	1,180	0.050	0.189	24,100	870	0.047	0.189	18,300	580	0.036	0.189	14,500	400	0.032	0.170
"	6	24,800	970	0.037	0.120	20,700	720	0.034	0.120	16,100	490	0.026	0.120	12,800	340	0.023	0.108
"	8	20,700	760	0.024	0.051	17,300	570	0.021	0.051	13,900	400	0.016	0.051	11,100	280	0.014	0.046
"	10	18,000	620	0.016	0.026	15,100	470	0.014	0.026	12,400	340	0.011	0.026	9,900	230	0.010	0.023
"	12	16,100	520	0.011	0.015	13,500	390	0.010	0.015	11,400	290	0.008	0.015	9,100	200	0.007	0.014
"	16	13,400	380	0.006	0.006	11,300	290	0.005	0.006	9,800	220	0.004	0.006	7,900	150	0.004	0.005
"	20	11,700	280	0.004	0.003	9,900	210	0.004	0.003	8,800	170	0.003	0.003	7,000	120	0.003	0.003
"	25	10,800	120	0.003	0.001	9,200	90	0.002	0.001	8,800	80	0.002	0.001	7,100	50	0.002	0.001
"	30	9,700	50	0.002	0.001	8,200	40	0.002	0.001	8,100	30	0.001	0.001	6,500	30	0.001	0.0009

피삭재 Material		구조용강/탄소강/회주철 Mild steels / Carbon Steels / Gray cast irons SS/SC/FC				공구강/금형강 Tool steels / Mold steels SCM/HPM				합금강/프리하든강 Alloy Steels / Pre-hardened Steels NAK80/KP4M				고경도강 Hardened Steels STAVAX/SKD11			
경도 Hardness		~30HRc				30 ~ 40HRc				40 ~ 45HRc				45 ~ 55HRc			
외경 Outside Diameter	유효장 Effective Length	RPM	FEED	Ap Axial Depth	Ae Radial Depth	RPM	FEED	Ap Axial Depth	Ae Radial Depth	RPM	FEED	Ap Axial Depth	Ae Radial Depth	RPM	FEED	Ap Axial Depth	Ae Radial Depth
∅ 1.4	6	23,300	1,070	0.052	0.222	19,400	800	0.047	0.222	14,800	540	0.060	0.222	11,900	370	0.054	0.200
"	8	19,500	850	0.035	0.094	16,300	640	0.032	0.094	12,900	440	0.025	0.094	10,300	310	0.023	0.085
"	10	16,900	710	0.025	0.048	14,200	530	0.022	0.048	11,500	380	0.017	0.048	9,200	260	0.015	0.043
"	14	13,700	510	0.013	0.018	11,500	390	0.012	0.018	9,700	290	0.009	0.018	7,800	200	0.008	0.016
"	16	12,600	450	0.010	0.012	10,600	340	0.009	0.012	9,100	250	0.007	0.012	7,300	180	0.006	0.011
"	20	10,300	300	0.006	0.005	8,700	230	0.005	0.005	7,800	180	0.004	0.005	6,200	120	0.004	0.005
∅ 1.5	4	26,600	1,340	0.073	0.462	22,100	1,000	0.065	0.462	16,300	640	0.051	0.462	13,000	440	0.046	0.416
"	6	22,800	1,120	0.057	0.293	19,000	840	0.051	0.293	14,400	550	0.040	0.293	11,500	380	0.036	0.264
"	8	19,000	900	0.041	0.124	15,900	670	0.037	0.124	12,500	460	0.029	0.124	10,000	320	0.026	0.112
"	10	16,600	750	0.030	0.063	13,800	560	0.027	0.063	11,200	390	0.021	0.063	8,900	270	0.019	0.057
"	12	14,800	630	0.023	0.037	12,400	470	0.020	0.037	10,200	340	0.016	0.037	8,200	240	0.014	0.033
"	14	13,400	550	0.017	0.023	11,200	410	0.016	0.023	9,500	300	0.012	0.023	7,600	210	0.011	0.021
"	16	12,300	480	0.013	0.015	10,300	360	0.012	0.015	8,900	270	0.009	0.015	7,100	190	0.008	0.014
"	18	11,500	420	0.011	0.011	9,600	310	0.010	0.011	8,400	240	0.007	0.011	6,700	170	0.006	0.010
"	20	10,700	370	0.009	0.008	9,000	280	0.008	0.008	7,900	220	0.006	0.008	6,300	150	0.005	0.007
"	25	9,300	270	0.005	0.004	7,800	200	0.005	0.004	7,100	160	0.004	0.004	5,700	110	0.004	0.004
"	30	8,300	200	0.004	0.002	7,000	150	0.004	0.002	6,500	120	0.003	0.002	5,200	90	0.003	0.002
∅ 1.6	10	16,100	780	0.035	0.082	13,500	580	0.032	0.082	10,800	410	0.025	0.082	8,600	280	0.018	0.074
"	14	13,000	580	0.020	0.030	10,900	430	0.018	0.030	9,100	320	0.014	0.030	7,300	220	0.010	0.027
"	18	11,100	450	0.013	0.014	9,300	340	0.012	0.014	8,000	260	0.009	0.014	6,400	180	0.006	0.013
∅ 2	4	23,000	1,500	0.070	0.966	20,000	1,200	0.060	0.966	14,000	750	0.052	0.966	12,000	500	0.040	0.869
"	6	20,300	1,350	0.064	0.926	17,400	1,030	0.058	0.926	12,500	650	0.045	0.926	10,000	450	0.032	0.833
"	8	17,000	1,090	0.054	0.391	14,500	830	0.048	0.391	10,800	540	0.038	0.391	8,700	380	0.027	0.352
"	10	14,800	920	0.045	0.200	12,600	700	0.040	0.200	9,700	470	0.031	0.200	7,800	330	0.022	0.180
"	12	13,200	790	0.037	0.116	11,200	600	0.034	0.116	8,900	420	0.026	0.116	7,100	290	0.019	0.104
"	14	12,000	700	0.031	0.073	10,200	530	0.028	0.073	8,200	370	0.022	0.073	6,600	260	0.016	0.066
"	16	11,100	620	0.026	0.049	9,400	470	0.024	0.049	7,700	340	0.018	0.049	6,100	230	0.013	0.044
"	18	10,300	550	0.022	0.034	8,700	420	0.020	0.034	7,200	310	0.015	0.034	5,800	210	0.011	0.031
"	20	9,600	500	0.018	0.025	8,100	380	0.016	0.025	6,900	280	0.013	0.025	5,500	190	0.009	0.023
"	22	8,700	420	0.014	0.018	7,500	320	0.014	0.018	6,500	250	0.010	0.018	5,200	170	0.008	0.016
"	25	8,400	390	0.012	0.013	7,100	290	0.011	0.013	6,200	230	0.008	0.013	4,900	160	0.006	0.012
"	30	7,500	310	0.008	0.007	6,300	230	0.007	0.007	5,600	180	0.005	0.007	4,500	130	0.004	0.006
∅ 2.5	8	15,000	1,340	0.077	0.954	12,800	1,020	0.069	0.954	9,600	670	0.054	0.954	7,700	460	0.039	0.859
"	10	13,100	1,140	0.068	0.488	11,100	860	0.061	0.488	8,600	590	0.048	0.488	6,900	400	0.034	0.439
"	12	11,800	1,000	0.060	0.283	10,000	750	0.054	0.283	7,900	520	0.042	0.283	6,300	360	0.030	0.255
"	16	9,900	790	0.045	0.119	8,400	590	0.040	0.119	6,800	430	0.031	0.119	5,500	290	0.022	0.107
"	20	8,700	650	0.033	0.061	7,300	490	0.030	0.061	6,100	360	0.023	0.061	4,900	250	0.017	0.055
"	25	7,600	520	0.022	0.031	6,400	390	0.019	0.031	5,500	300	0.015	0.031	4,400	210	0.011	0.028
"	30	6,800	430	0.014	0.018	5,700	320	0.012	0.018	5,000	250	0.010	0.018	4,000	1,700	0.007	0.016
"	35	6,200	380	0.009	0.012	5,200	280	0.008	0.012	4,800	190	0.007	0.012	3,800	1,400	0.005	0.011
"	40	5,700	290	0.005	0.008	4,800	220	0.004	0.008	4,400	170	0.003	0.008	3,500	120	0.002	0.007
"	50	5,000	190	0.001	0.004	4,200	140	0.001	0.004	3,900	120	0.001	0.004	3,100	80	0.001	0.004
∅ 3	6	13,200	1,470	0.103	1.978	10,900	1,080	0.093	1.978	8,000	700	0.072	1.978	6,400	480	0.052	1.780
"	10	11,600	1,270	0.092	1.013	9,600	930	0.083	1.013	7,200	620	0.064	1.013	5,800	430	0.046	0.912
"	12	10,500	1,110	0.081	0.586	8,700	830	0.073	0.586	6,700	560	0.057	0.586	5,300	380	0.041	0.527
"	16	8,900	900	0.064	0.247	7,400	670	0.058	0.247	5,900	470	0.045	0.247	4,700	320	0.032	0.222
"	20	7,800	750	0.050	0.127	6,600	560	0.045	0.127	5,300	400	0.035	0.127	4,300	280	0.025	0.114
"	25	6,900	620	0.036	0.065	5,800	460	0.032	0.065	4,800	340	0.025	0.065	3,900	230	0.018	0.059
"	30	6,200	520	0.026	0.038	5,200	390	0.023	0.038	4,500	290	0.018	0.038	3,600	200	0.013	0.034
"	35	5,700	440	0.018	0.024	4,800	330	0.016	0.024	4,200	250	0.013	0.024	3,300	170	0.009	0.022
"	40	5,300	370	0.013	0.016	4,500	280	0.012	0.016	3,900	220	0.009	0.016	3,100	150	0.006	0.014
"	45	5,000	330	0.008	0.012	4,200	230	0.008	0.012	3,700	180	0.006	0.012	2,900	130	0.005	0.011
"	50	4,700	270	0.006	0.008	3,900	200	0.005	0.008	3,600	160	0.004	0.008	2,800	110	0.003	0.007
"	60	4,500	250	0.003	0.005	3,600	180	0.003	0.005	3,200	130	0.003	0.005	2,500	90	0.002	0.005
∅ 4	8	10,000	1,600	0.140	1.990	8,800	1,100	0.140	1.990	6,800	770	0.093	1.990	5,300	500	0.070	1.791
"	10	9,200	1,400	0.120	1.960	8,000	1,000	0.120	1.960	5,900	690	0.085	1.960	4,700	460	0.066	1.764
"	12	8,500	1,280	0.112	1.852	7,100	950	0.101	1.852	5,100	600	0.078	1.852	4,100	410	0.056	1.667
"	16	7,200	1,050	0.093	0.781	6,000	770	0.084	0.781	4,400	510	0.065	0.781	3,600	350	0.046	0.703
"	20	6,300	880	0.077	0.400	5,200	650	0.069	0.400	4,000	440	0.054	0.400	3,200	300	0.038	0.360
"	25	5,600	750	0.061	0.205	4,600	540	0.055	0.205	3,600	380	0.042	0.205	2,900	260	0.030	0.185
"	30	5,000	630	0.048	0.119	4,100	460	0.043	0.119	3,300	330	0.033	0.119	2,600	230	0.024	0.107
"	35	4,600	540	0.038	0.075	3,800	400	0.034	0.075	3,100	290	0.026	0.075	2,500	200	0.019	0.068
"	40	4,200	470	0.030	0.050	3,500	350	0.027	0.050	2,900	250	0.021	0.050	2,300	180	0.015	0.045
"	45	3,900	410	0.023	0.035	3,300	300	0.021	0.035	2,700	230	0.016	0.035	2,200	160	0.012	0.032
"	50	3,700	360	0.018	0.026	3,100	270	0.016	0.026	2,600	200	0.013	0.026	2,100	140	0.009	0.023
"	55	3,500	320	0.015	0.020	2,950	250	0.015	0.020	2,500	180	0.010	0.020	2,000	130	0.007	0.018
"	60	3,300	280	0.011	0.015	2,800	210	0.010	0.015	2,400	160	0.008	0.015	1,900	110	0.006	0.014

피삭재 Material		구조용강 / 탄소강 / 회주철 Mild steels / Carbon Steels / Gray cast irons SS / SC / FC				공구강 / 금형강 Tool steels / Mold steels SCM / HPM				합금강 / 프리하든강 Alloy Steels / Pre-hardened Steels NAK80 / KP4M				고경도강 Hardened Steels STAVAX / SKD11			
경도 Hardness		~30HRc				30 ~ 40HRc				40 ~ 45HRc				45 ~ 55HRc			
외경 Outside Diameter	유효장 Effective Length	RPM	FEED	Ap Axial Depth	Ae Radial Depth	RPM	FEED	Ap Axial Depth	Ae Radial Depth	RPM	FEED	Ap Axial Depth	Ae Radial Depth	RPM	FEED	Ap Axial Depth	Ae Radial Depth
∅ 5	16	6,000	1,140	0.127	1.907	5,100	860	0.114	1.907	3,500	520	0.089	1.907	2,800	360	0.064	1.716
"	20	5,300	980	0.121	0.977	4,400	730	0.109	0.977	3,100	440	0.085	0.977	2,500	310	0.061	0.879
"	25	4,600	820	0.109	0.500	3,800	600	0.099	0.500	2,800	390	0.077	0.500	2,200	270	0.055	0.450
"	30	4,200	710	0.094	0.289	3,400	510	0.085	0.289	2,500	340	0.066	0.289	2,000	230	0.047	0.260
"	35	3,800	620	0.077	0.182	3,100	450	0.069	0.182	2,300	300	0.054	0.182	1,900	210	0.038	0.164
"	40	3,500	540	0.060	0.122	2,800	390	0.054	0.122	2,200	270	0.042	0.122	1,700	180	0.030	0.110
"	50	3,100	430	0.031	0.063	2,400	300	0.028	0.063	1,900	210	0.022	0.063	1,500	150	0.016	0.057
"	60	2,800	350	0.013	0.036	2,100	240	0.012	0.036	1,800	170	0.009	0.036	1,400	120	0.007	0.032
∅ 6	20	4,200	960	0.126	2.025	3,800	780	0.114	2.025	2,600	470	0.088	2.025	2,100	330	0.063	1.823
"	30	3,400	730	0.109	0.600	2,800	540	0.099	0.600	2,000	340	0.077	0.600	1,600	240	0.055	0.540
"	40	3,000	600	0.083	0.253	2,300	410	0.074	0.253	1,700	260	0.058	0.253	1,300	170	0.041	0.228
"	50	2,600	480	0.054	0.130	1,900	310	0.049	0.130	1,500	220	0.038	0.130	1,200	160	0.027	0.117
"	60	2,400	410	0.031	0.075	1,700	260	0.028	0.075	1,300	170	0.022	0.075	1,000	120	0.016	0.068
∅ 8	20	3,200	910	0.180	1.600	2,800	710	0.160	1.600	2,300	450	0.130	1.600	1,700	330	0.090	1.440
"	40	2,600	600	0.120	0.200	2,000	410	0.100	0.200	1,500	250	0.080	0.200	1,100	160	0.060	0.180
∅ 10	25	2,900	890	0.200	1.760	2,700	680	0.180	1.760	2,100	430	0.130	1.760	1,500	310	0.080	1.584
"	45	2,200	580	0.140	0.240	2,000	400	0.120	0.240	1,300	220	0.070	0.240	900	150	0.050	0.216

**절입량**  
Depth of Cut

Slotting

- Ap : Axial Depth
- D : Outside Diameter

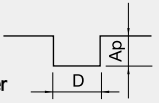

Side Milling

- Ap : Axial Depth
- Ae : Radial Depth

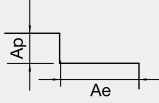

- 날 끝이 정밀하게 연삭되어 있습니다. 파손을 피하기 위해 가능하면 비접촉 방식으로 측정 하십시오.
- HRC60 이상 고경도강 가공 시 같은 직경의 같은 비율로 20% DOWN 시켜주십시오.
- 상기 절삭조건은 참고 수치이므로 실 가공시 가공 형상, 가공 목적, 적용 기계에 따라 조건 변경 요망합니다.
- 조건표가 기계의 최대 스피드 속도를 초과하거나 버 및 적열 현상이 발생할 때 스피드 속도와 이송속도를 비례하여 조정 하십시오.
- 진동이 적고 강성이 좋은 공작기계 사용 요망 합니다.(∅1이하 사용시 진동 허용 관리 5 $\mu$ m이내 일것.)
- 에어브로, 절삭유, 오일 미스트 콜러트를 추천하며, 칩을 잘 제거하고 가공시 발열과 발화에 주의 하십시오
- The edge of the flute precisely grinded. If you want to measure the tool, and to avoid damaging on the flutes, use non-contact measuring method.
- When milling workpiece, HRC over 60 hardened steel , reduce 20% of the RPM and feed compared to the same diameter.
- Use this table for your reference. Adjust the parameters depending on your machining geometry, machining purpose and CNC.
- Use a machine with low vibration and good rigidity ( $\varnothing 1$  or less, the vibration tolerance management should be within 5 $\mu$ m).
- Air blow or mist coolants are recommended and note for chip emission, heat, or ignition.

피삭재 Material		구조용강 / 탄소강 / 회주철 Mild steels / Carbon Steels / Gray cast irons SS / SC / FC				공구강 / 금형강 Tool steels / Mold steels SCM / HPM				합금강 / 프리하드강 Alloy Steels / Pre-hardened Steels NAK80 / KP4M				고경도강 Hardened Steels STAVAX / SKD11			
경도 Hardness		~30Hrc				30 ~ 40Hrc				40 ~ 45Hrc				45 ~ 55Hrc			
외경 Outside Diameter	유효장 Effective Length	RPM	FEED	Ap Axial Depth	Ae Radial Depth	RPM	FEED	Ap Axial Depth	Ae Radial Depth	RPM	FEED	Ap Axial Depth	Ae Radial Depth	RPM	FEED	Ap Axial Depth	Ae Radial Depth
ø 0.8	8	25,000	750	0.009	0.01	21,600	560	0.008	0.01	18,300	450	0.006	0.01	15,900	300	0.004	0.009
"	16	16,800	340	0.002	0.001	15,700	270	0.002	0.001	13,300	240	0.001	0.001	10,400	200	0.001	0.001
ø 1	8	24,000	720	0.014	0.024	20,300	490	0.013	0.024	16,900	390	0.010	0.024	14,200	265	0.007	0.022
"	16	15,800	325	0.004	0.003	14,300	250	0.003	0.003	12,200	220	0.003	0.003	9,200	178	0.002	0.003
"	25	12,600	165	0.003	0.001	11,200	120	0.002	0.001	10,800	105	0.002	0.001	8,300	88	0.001	0.001
ø 1.5	8	21,000	980	0.041	0.124	18,800	740	0.037	0.124	14,600	520	0.029	0.124	12,400	355	0.020	0.112
"	16	13,600	544	0.013	0.015	12,200	410	0.012	0.015	10,500	322	0.009	0.015	8,000	230	0.007	0.014
"	25	11,400	318	0.005	0.004	10,500	240	0.005	0.004	8,600	196	0.004	0.004	6,200	138	0.003	0.004
ø 2	8	19,600	1,197	0.054	0.391	17,000	970	0.048	0.391	12,800	630	0.038	0.391	10,600	470	0.027	0.352
"	16	12,300	740	0.026	0.049	11,600	574	0.024	0.049	9,800	378	0.018	0.049	7,300	268	0.013	0.044
"	25	10,100	456	0.012	0.013	9,700	348	0.011	0.013	7,900	262	0.008	0.013	6,400	184	0.006	0.012
ø 2.5	10	16,600	1,240	0.068	0.488	14,300	1,035	0.061	0.488	10,200	689	0.048	0.488	8,350	510	0.034	0.439
"	16	11,600	890	0.045	0.119	9,800	710	0.040	0.119	7,220	480	0.031	0.119	6,700	326	0.022	0.107
"	25	8,700	630	0.022	0.031	8,300	460	0.019	0.031	6,360	338	0.015	0.031	5,500	273	0.011	0.028
ø 3	8	14,800	1,390	0.092	0.350	12,100	1,100	0.083	0.350	8,800	736	0.064	0.350	6,900	553	0.046	0.315
"	16	10,200	968	0.064	0.247	8,600	816	0.058	0.247	6,300	543	0.045	0.247	5,890	362	0.032	0.222
"	25	7,600	740	0.036	0.038	7,100	518	0.032	0.038	5,880	397	0.025	0.038	3,900	293	0.018	0.034
"	35	6,200	415	0.018	0.024	5,300	374	0.016	0.024	4,730	322	0.013	0.024	3,300	216	0.009	0.022
ø 4	8	12,300	1,830	0.140	0.950	10,200	1,210	0.140	0.950	7,400	848	0.093	0.900	6,300	500	0.070	0.810
"	16	8,600	1,240	0.093	0.580	7,200	860	0.084	0.580	5,100	573	0.065	0.580	5,150	397	0.046	0.522
"	25	6,400	890	0.061	0.205	5,000	590	0.055	0.205	4,180	433	0.042	0.205	3,180	304	0.030	0.185
"	40	4,950	510	0.030	0.050	3,900	385	0.027	0.050	3,300	341	0.021	0.050	2,770	208	0.015	0.045
ø 5	16	7,200	1,280	0.127	1.250	6,400	944	0.114	1.250	4,387	554	0.089	1.250	4,220	378	0.064	1.125
"	25	5,400	955	0.109	0.500	4,600	665	0.099	0.500	3,668	412	0.077	0.500	2,740	280	0.055	0.450
"	40	4,100	660	0.060	0.122	3,300	470	0.054	0.122	3,655	298	0.042	0.122	2,320	180	0.030	0.110
ø 6	20	4,880	1,088	0.126	2.025	4,433	726	0.114	2.025	2,980	528	0.088	2.025	2,640	356	0.063	1.823
"	40	3,800	720	0.083	0.253	2,950	497	0.074	0.253	2,100	326	0.058	0.253	2,078	226	0.041	0.228
ø 8	20	4,460	980	0.180	1.600	3,600	787	0.160	1.600	2,540	487	0.130	1.600	2,430	343	0.090	1.440
"	40	3,400	780	0.120	0.200	2,460	516	0.100	0.200	1,890	297	0.080	0.200	1,770	211	0.060	0.180
ø 10	25	3,400	926	0.200	1.760	3,160	726	0.180	1.760	2,360	467	0.130	1.760	1,650	326	0.080	1.584
"	35	2,170	640	0.140	0.240	2,120	615	0.120	0.240	1,780	412	0.090	0.240	1,180	192	0.070	0.216
ø 12	30	2,500	710	0.220	1.840	2,300	580	0.200	1.840	2,000	400	0.140	1.840	1,400	280	0.080	1.656
"	40	1,880	526	0.120	0.280	1,820	474	0.110	0.280	1,690	345	0.080	0.280	1,020	184	0.060	0.252

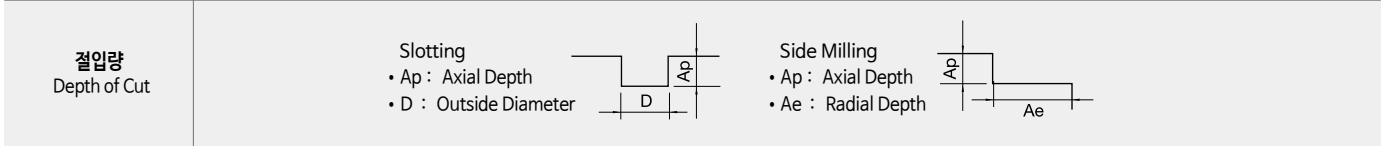

- 날 끝이 정밀하게 연삭되어 있습니다. 파손을 피하기 위해 가능하면 비접촉 방식으로 측정하십시오.
- HRC60 이상 고경도강 가공 시 같은 직경의 같은 비율로 20% DOWN 시켜주십시오.
- 상기 절삭조건은 참고 수치이므로 실 가공시 가공 형상, 가공 목적, 적용 기계에 따라 조건 변경 요망합니다.
- 조건표가 기계의 최대 스피들 속도를 초과하거나 버 및 적열 현상이 발생할 때 스피들 속도와 이송속도를 비례하여 조정하십시오.
- 진동이 적고 강성이 좋은 공작기계 사용 요망 합니다.(ø1이하 사용자 진동 허용 관리 5µm 이내 일것.)
- 에어브로, 절삭유, 오일 미스트 콜러트를 추천하며, 칩을 잘 제거하고 가공시 발열과 발화에 주의 하십시오
- The edge of the flute precisely grinded. If you want to measure the tool, and to avoid damaging on the flutes, use non-contact measuring method.
- When milling workpiece, HRC over 60 hardened steel , reduce 20% of the RPM and feed compared to the same diameter.
- Use this table for your reference. Adjust the parameters depending on your machining geometry, machining purpose and CNC.
- Use a machine with low vibration and good rigidity (ø1 or less, the vibration tolerance management should be within 5µm).
- Air blow or mist coolants are recommended and note for chip emission, heat, or ignition.

## 홈절삭 Slotting

피삭재 Material	공구강 / 금형강 Tool steels / Mold steels SCM/HPM		합금강 / 프리하든강 Alloy Steels / Pre-hardened Steels NAK80 / KP4M		고경도강 Hardened Steels STAVAX / SKD11		열처리 / 고경도강 Heat-treated steels / Hardened Steels SKD11 / SKD61	
	30 ~ 40Hrc		40 ~ 45Hrc		45 ~ 55Hrc		55 ~ 62Hrc	
외경 Outside Diameter	RPM	FEED	RPM	FEED	RPM	FEED	RPM	FEED
∅0.1	50,000	150	45,000	150	40,000	135	33,000	75
∅0.2	50,000	195	45,000	173	40,000	143	33,000	90
∅0.3	50,000	285	45,000	210	40,000	173	33,000	105
∅0.4	50,000	353	45,000	270	40,000	210	33,000	135
∅0.5	50,000	555	45,000	420	40,000	330	33,000	210
∅0.6	50,000	705	45,000	540	40,000	428	30,000	240
∅0.8	50,000	900	40,000	660	30,000	443	25,000	278
∅0.9	49,000	983	39,000	780	27,800	495	22,700	308
∅1	48,000	1,125	38,000	855	25,500	540	20,500	323
∅2	33,300	1,275	26,000	1,020	17,500	630	14,500	390
∅3	21,800	1,275	17,300	1,020	11,500	630	9,500	390
∅4	16,700	1,320	13,200	1,050	8,800	660	7,200	405
∅5	15,700	1,500	12,500	1,208	8,300	750	6,400	428
∅6	13,100	1,425	10,350	1,155	6,900	720	5,300	420
∅8	9,880	1,395	7,800	1,080	5,200	668	4,000	383
∅10	7,800	1,275	6,150	1,020	4,100	623	3,200	360
∅12	6,650	1,275	5,250	1,020	3,500	623	2,650	360
∅16	5,540	1,170	4,340	915	2,600	540	1,840	270
∅18	5,540	1,170	4,340	915	2,600	540	1,840	270
∅20	4,640	1,080	4,340	855	2,100	450	1,460	270

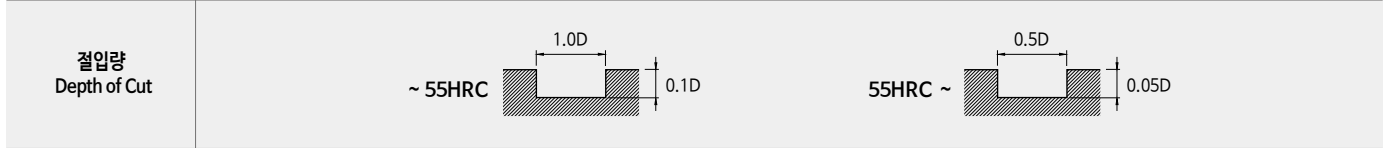

## 측면절삭 Side Cutting

피삭재 Material	공구강 / 금형강 Tool steels / Mold steels SCM/HPM		합금강 / 프리하든강 Alloy Steels / Pre-hardened Steels NAK80 / KP4M		고경도강 Hardened Steels STAVAX / SKD11		열처리 / 고경도강 Heat-treated steels / Hardened Steels SKD11 / SKD61	
	30 ~ 40Hrc		40 ~ 45Hrc		45 ~ 55Hrc		55 ~ 62Hrc	
외경 Outside Diameter	RPM	FEED	RPM	FEED	RPM	FEED	RPM	FEED
∅1	48,000	788	38,000	615	25,500	383	20,500	233
∅2	33,300	900	26,000	728	17,500	450	14,500	278
∅3	21,800	900	17,300	728	11,500	450	9,500	278
∅4	16,700	938	13,200	750	8,800	469	7,200	289
∅5	15,700	1088	12,500	863	8,300	533	6,400	308
∅6	13,100	1013	10,350	825	6,900	518	5,300	300
∅8	9,880	990	7,800	773	5,200	476	4,000	274
∅10	7,800	900	6,150	728	4,100	443	3,200	255
∅12	6,650	900	5,250	728	3,500	443	2,650	255
∅16	5,540	750	4,340	660	2,600	398	1,840	255
∅18	5,540	750	4,200	660	2,450	398	1,650	225
∅20	4,640	713	3,650	600	2,100	375	1,460	221

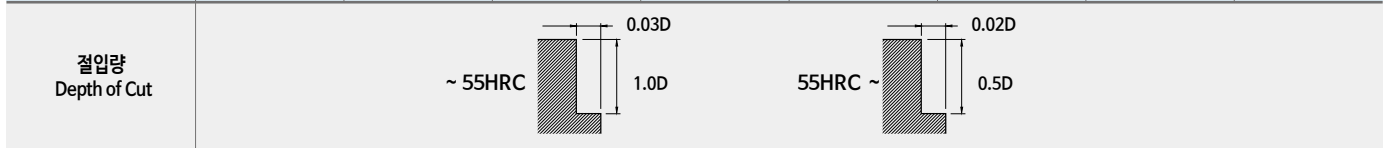

- 날 끝이 정밀하게 연삭되어 있습니다. 파손을 피하기 위해 가능하면 비접촉 방식으로 측정하십시오.
- HRC60 이상 고경도강 가공 시 같은 직경의 같은 비율로 20% DOWN 시켜주십시오.
- 상기 절삭조건은 참고 수치이므로 실 가공시 가공 형상, 가공 목적, 적용 기계에 따라 조건 변경 요망합니다.
- 조건표가 기계의 최대 스피들 속도를 초과하거나 버 및 적열 현상이 발생할 때 스피들 속도와 이송속도를 비례하여 조정하십시오.
- 진동이 적고 강성이 좋은 공작기계 사용 요망 합니다(∅1이하 사용시 진동 허용 관리 5μm이내 일것.)
- 에어브로, 절삭유, 오일미스트쿨러를추천하며, 칩을 잘 제거하고 가공시 발열과 발화에 주의 하십시오
- The edge of the flute precisely grinded. If you want to measure the tool, and to avoid damaging on the flutes, use non-contact measuring method.
- When milling workpiece, HRC over 60 hardened steel , reduce 20% of the RPM and feed compared to the same diameter.
- Use this table for your reference. Adjust the parameters depending on your machining geometry, machining purpose and CNC.
- Use a machine with low vibration and good rigidity (∅1 or less, the vibration tolerance management should be within 5μm).
- Air blow or mist coolants are recommended and note for chip emission, heat, or ignition.

홈절삭 Slotting																
피삭재 Material	공구강 / 금형강 Tool steels / Mold steels SCM/HPM				합금강/프리하든강 Alloy Steels / Pre-hardened Steels NAK80 / KP4M				고경도강 Hardened Steels STAVAX / SKD11				열처리 / 고경도강 Heat-treated steels / Hardened Steels SKD11 / SKD61			
경도 Hardness	30 ~ 40HRC				40 ~ 45HRC				45 ~ 55HRC				55 ~ 62HRC			
외경 Outside Diameter	RPM	FEED	Ap Axial Depth	Ae Radial Depth	RPM	FEED	Ap Axial Depth	Ae Radial Depth	RPM	FEED	Ap Axial Depth	Ae Radial Depth	RPM	FEED	Ap Axial Depth	Ae Radial Depth
ø 0.3	50,000	238	0.03	0.3	45,000	175	0.03	0.3	40,000	144	0.02	0.150	33,000	88	0.01	0.075
ø 0.4	50,000	294	0.04	0.4	45,000	225	0.04	0.4	40,000	175	0.02	0.200	33,000	113	0.01	0.100
ø 0.5	50,000	463	0.05	0.5	45,000	350	0.05	0.5	40,000	275	0.03	0.250	33,000	175	0.01	0.125
ø 0.6	50,000	588	0.06	0.6	45,000	450	0.06	0.6	40,000	356	0.03	0.300	30,000	200	0.02	0.150
ø 0.8	50,000	750	0.08	0.8	40,000	550	0.08	0.8	30,000	369	0.04	0.400	25,000	231	0.02	0.200
ø 0.9	49,000	819	0.09	0.9	39,000	650	0.09	0.9	27,800	413	0.05	0.450	22,700	256	0.02	0.225
ø 1	48,000	1,313	0.1	1.0	38,000	855	0.1	1.0	25,500	538	0.05	0.500	20,500	325	0.03	0.250
ø 2	33,300	1,488	0.2	2.0	26,000	1,020	0.2	2.0	17,500	625	0.10	1.000	14,500	388	0.05	0.500
ø 3	21,800	1,488	0.3	3.0	17,300	1,020	0.3	3.0	11,500	625	0.15	1.500	9,500	388	0.08	0.750
ø 4	16,700	1,540	0.4	4.0	13,200	1,050	0.4	4.0	8,800	663	0.20	2.000	7,200	406	0.10	1.000
ø 5	15,700	1,750	0.5	5.0	12,500	1,208	0.5	5.0	8,300	750	0.25	2.500	6,400	425	0.13	1.250
ø 6	13,100	1,663	0.6	6.0	10,350	1,155	0.6	6.0	6,900	719	0.30	3.000	5,300	419	0.15	1.500
ø 8	9,880	1,625	0.8	8.0	7,800	1,080	0.8	8.0	5,200	669	0.40	4.000	4,000	375	0.20	2.000
ø 10	7,800	1,488	1.0	10.0	6,150	1,020	1.0	10.0	4,100	625	0.50	5.000	3,200	363	0.25	2.500
ø 12	6,650	1,488	1.2	12.0	5,250	1,020	1.2	12.0	3,500	625	0.60	6.000	2,650	363	0.30	3.000
ø 16	5,540	1,363	1.6	16.0	4,340	915	1.6	16.0	2,600	538	0.80	8.000	1,840	269	0.40	4.000
ø 18	5,540	1,363	1.8	18.0	4,340	913	1.8	18.0	2,600	538	0.90	9.000	1,840	269	0.45	4.500
ø 20	4,640	1,260	2.0	20.0	4,340	912	2.0	20.0	2,600	538	1.00	10.000	1,840	269	0.50	5.000

절입량  
Depth of Cut

Slotting  
• Ap : Axial Depth  
• D : Outside Diameter

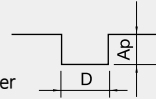

측면절삭 Side Cutting																
피삭재 Material	공구강 / 금형강 Tool steels / Mold steels SCM/HPM				합금강/프리하든강 Alloy Steels / Pre-hardened Steels NAK80 / KP4M				고경도강 Hardened Steels STAVAX / SKD11				열처리 / 고경도강 Heat-treated steels / Hardened Steels SKD11 / SKD61			
경도 Hardness	30 ~ 40HRC				40 ~ 50HRC				45 ~ 55HRC				55 ~ 62HRC			
외경 Outside Diameter	RPM	FEED	Ap Axial Depth	Ae Radial Depth	RPM	FEED	Ap Axial Depth	Ae Radial Depth	RPM	FEED	Ap Axial Depth	Ae Radial Depth	RPM	FEED	Ap Axial Depth	Ae Radial Depth
ø 0.3	50,000	214	0.3	0.009	45,000	158	0.3	0.009	40,000	129	0.15	0.006	33,000	79	0.08	0.003
ø 0.4	50,000	264	0.4	0.012	45,000	203	0.4	0.012	40,000	158	0.20	0.008	33,000	101	0.10	0.004
ø 0.5	50,000	416	0.5	0.015	45,000	315	0.5	0.015	40,000	248	0.25	0.010	33,000	158	0.13	0.005
ø 0.6	50,000	529	0.6	0.018	45,000	405	0.6	0.018	40,000	321	0.30	0.012	30,000	180	0.15	0.006
ø 0.8	50,000	675	0.8	0.024	40,000	495	0.8	0.024	30,000	332	0.40	0.016	25,000	208	0.20	0.008
ø 0.9	49,000	737	0.9	0.027	39,000	585	0.9	0.027	27,800	371	0.45	0.018	22,700	231	0.23	0.009
ø 1	48,000	1,181	1.0	0.030	38,000	770	1.0	0.030	25,500	484	0.50	0.020	20,500	293	0.25	0.010
ø 2	33,300	1,339	2.0	0.060	26,000	918	2.0	0.060	17,500	563	1.00	0.040	14,500	349	0.50	0.020
ø 3	21,800	1,339	3.0	0.090	17,300	918	3.0	0.090	11,500	563	1.50	0.060	9,500	349	0.75	0.030
ø 4	16,700	1,386	4.0	0.120	13,200	945	4.0	0.120	8,800	596	2.00	0.080	7,200	366	1.00	0.040
ø 5	15,700	1,575	5.0	0.150	12,500	1,087	5.0	0.150	8,300	675	2.50	0.100	6,400	383	1.25	0.050
ø 6	13,100	1,496	6.0	0.180	10,350	1,040	6.0	0.180	6,900	647	3.00	0.120	5,300	377	1.50	0.060
ø 8	9,880	1,463	8.0	0.240	7,800	972	8.0	0.240	5,200	602	4.00	0.160	4,000	338	2.00	0.080
ø 10	7,800	1,339	10.0	0.300	6,150	918	10.0	0.300	4,100	563	5.00	0.200	3,200	326	2.50	0.100
ø 12	6,650	1,339	12.0	0.360	5,250	918	12.0	0.360	3,500	563	6.00	0.240	2,650	326	3.00	0.120
ø 16	5,540	1,226	16.0	0.480	4,340	824	16.0	0.480	2,600	484	8.00	0.320	1,840	242	4.00	0.160
ø 18	5,540	1,226	18.0	0.540	4,340	821	18.0	0.540	2,600	484	9.00	0.360	1,840	242	4.50	0.180
ø 20	4,640	1,134	20.0	0.600	4,340	821	20.0	0.600	2,600	484	10.00	0.400	1,840	242	5.00	0.200

절입량  
Depth of Cut

Side Milling  
• Ap : Axial Depth  
• Ae : Radial Depth

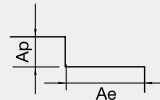

- 날 끝이 정밀하게 연삭되어 있습니다. 파손을 피하기 위해 가능하면 비접촉 방식으로 측정 하십시오.
- HRC60 이상 고경도강 가공 시 같은 직경의 같은 비율로 20% DOWN 시켜주십시오.
- 상기 절삭조건은 참고 수치이므로 실 가공시 가공 형상, 가공 목적, 적용 기계에 따라 조건 변경 요망합니다.
- 조건표가 기계의 최대 스피들 속도를 초과하거나 버 및 적열 현상이 발생할 때 스피들 속도와 이송속도를 비례하여 조정 하십시오.
- 진동이 적고 강성이 좋은 공작기계 사용 요망 합니다.(ø1이하 사용자 진동 허용 관리 5µm 이내 일것.)
- 에어브로, 절삭유, 오일미스트콜러너트를추천하며, 칩을 잘 제거하고 가공시 발열과 발화에 주의 하십시오

- The edge of the flute precisely grinded. If you want to measure the tool, and to avoid damaging on the flutes, use non-contact measuring method.
- When milling workpiece, HRC over 60 hardened steel , reduce 20% of the RPM and feed compared to the same diameter.
- Use this table for your reference. Adjust the parameters depending on your machining geometry, machining purpose and CNC.
- Use a machine with low vibration and good rigidity (ø1 or less, the vibration tolerance management should be within 5µm).
- Air blow or mist coolants are recommended and note for chip emission, heat, or ignition.

## 홈절삭 Slotting

피삭재 Material	공구강/금형강 Tool steels / Mold steels SCM/HPM		합금강/프리하든강 Alloy Steels / Pre-hardened Steels NAK80 / KP4M		고경도강 Hardened Steels STAVAX / SKD11		열처리 / 고경도강 Heat-treated steels / Hardened Steels SKD11 / SKD61	
	30 ~ 40Hrc		40 ~ 45Hrc		45 ~ 55Hrc		55 ~ 62Hrc	
외경 Outside Diameter	RPM	FEED	RPM	FEED	RPM	FEED	RPM	FEED
Ø1	40,000	293	40,000	264	40,000	237	40,000	71
Ø1.5	35,000	320	35,000	288	35,000	259	32,000	78
Ø2	32,000	330	24,000	297	15,000	267	17,500	80
Ø3	21,000	340	17,000	306	10,500	275	13,000	83
Ø4	17,000	460	13,500	414	8,500	373	8,000	112
Ø5	14,500	520	11,500	468	7,500	421	6,750	126
Ø6	12,500	550	10,000	495	6,500	446	5,500	134
Ø8	9,500	630	7,500	567	5,000	510	4,500	153
Ø10	8,000	829	6,500	721	4,000	577	3,550	173
Ø12	6,500	761	5,500	662	3,350	529	3,000	159
Ø16	5,000	761	4,100	662	2,500	529	2,250	159
Ø20	4,000	702	3,250	611	2,000	489	1,800	147
Ø25	3,250	630	2,600	548	1,600	438	1,400	132

절입량  
Depth of Cut

~ 50HRC

50HRC ~

## 측면절삭 Side Cutting

피삭재 Material	공구강/금형강 Tool steels / Mold steels SCM/HPM		합금강/프리하든강 Alloy Steels / Pre-hardened Steels NAK80 / KP4M		고경도강 Hardened Steels STAVAX / SKD11		열처리 / 고경도강 Heat-treated steels / Hardened Steels SKD11 / SKD61	
	30 ~ 40Hrc		40 ~ 45Hrc		45 ~ 55Hrc		55 ~ 62Hrc	
외경 Outside Diameter	RPM	FEED	RPM	FEED	RPM	FEED	RPM	FEED
Ø1	40,000	337	40,000	286	40,000	229	40,000	195
Ø1.5	35,000	368	35,000	313	35,000	250	35,000	213
Ø2	32,000	380	24,000	323	15,000	258	17,500	219
Ø3	21,000	391	17,000	332	10,500	266	13,000	226
Ø4	17,000	529	13,500	450	8,500	360	8,000	306
Ø5	14,500	598	11,500	508	7,500	407	6,750	346
Ø6	12,500	633	10,000	538	6,500	430	5,500	366
Ø8	9,500	725	7,500	616	5,000	493	4,500	419
Ø10	8,000	765	6,500	650	4,000	520	3,550	442
Ø12	6,500	638	5,500	542	3,350	434	3,000	368
Ø16	5,000	638	4,100	542	2,500	434	2,250	368
Ø20	4,000	606	3,250	515	2,000	412	1,800	350
Ø25	3,250	570	2,600	485	1,600	388	1,400	329

절입량  
Depth of Cut

~ 50HRC

50HRC ~

- 날 끝이 정밀하게 연삭되어 있습니다. 파손을 피하기 위해 가능하면 비접촉 방식으로 측정 하십시오.
- 상기 조건표는 2날 기준이며, 4날시 회전수는 유지하고, 피드는 안정적인 속도 내에서 최대 50% 까지 UP 해주십시오.
- HRC55 이상 고경도강 가공시 같은 직경의 같은 비율로 20% DOWN 해주십시오.
- 상기 절삭조건은 참고 수치이므로 실 가공시 가공 형상, 가공 목적, 적용 기계에 따라 조건변경 요망 합니다.
- 조건표가 기계의 최대 스피들 속도를 초과하거나 버 및 적열 현상이 발생할 때 스피들 속도와 이송속도를 비례하여 조정 하십시오.
- 진동이 적고 강성이 좋은 공작기계 사용 요망 합니다.(Ø1이하 사용시 진동 허용 관리 5µm이내 일것.)
- 에어브로, 절삭유, 오일미스트쿨러를추천하며, 칩을 잘 제거하고 가공시 발열과 발화에 주의 하십시오
- The edge of the flute precisely grinded. If you want to measure the tool, and to avoid damaging on the flutes, use non-contact measuring method.
- The parameters on the table is based on 2 flutes. For using 4 flutes, use the same RPM and raise up the feed up to 50% in stable milling condition.
- When milling workpiece, HRC over 60 hardened steel , reduce 20% of the RPM and feed compared to the same diameter.
- When milling workpiece, HRC over 60 hardened steel, reduce 20% of the RPM and feed compared to the same diameter.
- Use this table for your reference. Adjust the parameters depending on your machining geometry, machining purpose and CNC.
- Use a machine with low vibration and good rigidity (Ø1 or less, the vibration tolerance management should be within 5µm).
- Air blow or mist coolants are recommended and note for chip emission, heat, or ignition.

■ 6&8EM은 RPM 동일, FEED만 최대 50% Up 적용.

■ Use the same RPM and raise up the feed up to 50% for 6&8HEM.

• RPM : rev./min • Feed : mm/min

## 측면절삭 Side Cutting

피삭재 Material	공구강 / 금형강 Tool steels / Mold steels SCM/HPM				합금강/프리하든강 Alloy Steels / Pre-hardened Steels NAK80 / KP4M				고경도강 Hardened Steels STAVAX / SKD11				열처리 / 고경도강 Heat-treated steels / Hardened Steels SKD11 / SKD61						
	경도 Hardness				30 ~ 40HRC				40 ~ 45HRC				50 ~ 55HRC				55 ~ 62HRC		
외경 Outside Diameter	RPM	FEED	Ap	Ae	RPM	FEED	Ap	Ae	RPM	FEED	Ap	Ae	RPM	FEED	Ap	Ae			
			Axial Depth	Radial Depth			Axial Depth	Radial Depth			Axial Depth	Radial Depth			Axial Depth	Radial Depth			
ø 1	24,000	149	1.5	0.05	9,600	33	0.5	0.03	19,200	111	1.5	0.05	9,300	28	0.5	0.03			
ø 1.5	24,000	186	2.25	0.075	9,600	42	0.75	0.045	19,200	139	2.25	0.075	9,000	36	0.75	0.045			
ø 2	24,000	248	3	0.1	9,600	56	1	0.06	19,200	186	3	0.1	8,200	47	1	0.06			
ø 3	23,040	564	4.5	0.15	9,216	127	1.5	0.09	18,432	423	4.5	0.15	7,373	108	1.5	0.09			
ø 4	17,280	653	6	0.2	6,912	147	2	0.12	13,824	490	6	0.2	5,530	125	2	0.12			
ø 5	8,640	743	7.5	0.25	3,456	167	2.5	0.15	6,912	557	7.5	0.25	2,765	142	2.5	0.15			
ø 6	6,480	861	9	0.3	2,592	194	3	0.18	5,184	646	9	0.3	2,074	165	3	0.18			
ø 8	5,184	861	12	0.4	2,074	194	4	0.24	4,147	646	12	0.4	1,659	165	4	0.24			
ø 10	4,320	861	15	0.5	1,728	194	5	0.3	3,456	646	15	0.5	1,382	165	5	0.30			
ø 12	3,240	713	18	0.6	1,296	160	6	0.36	2,592	535	18	0.6	1,037	136	6	0.36			
ø 16	2,592	535	24	0.8	1,037	120	8	0.48	2,074	401	24	0.8	829	102	8	0.48			
ø 20	2,318	431	30	1	927	97	10	0.6	1,854	323	30	1	742	82	10	0.60			
ø 25	3,090	386	37.5	1.25	1,236	87	12.5	0.75	2,472	290	37.5	1.25	989	74	12.5	0.75			

절입량  
Depth of Cut

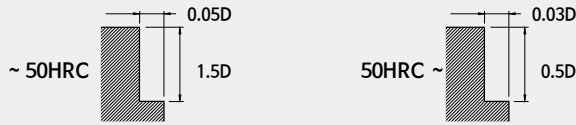

- 날 끝이 정밀하게 연삭되어 있습니다. 파손을 피하기 위해 가능하면 비접촉 방식으로 측정하십시오.
- 상기 조건표는 4날 기준이며, 6&8날시 회전수는 유지하고 피드는 안정적인 속도 내에서 최대 50%까지 UP 해주십시오.
- HRC62 이상 고경도강 가공시 같은 직경의 같은 비율로 20% DOWN 시켜주십시오.
- 유효장이 길게 체결할시 회전수와 피드를 같은 비율로 DOWN 해주십시오.
- 상기 절삭조건은 참고 수치이므로 실 가공시 가공 형상, 가공 목적, 적용 기계에 따라 조건변경 요망 합니다.
- 조건표가 기계의 최대 스피들 속도를 초과하거나 버 및 적열 현상이 발생할 때 스피들 속도와 이송속도를 비례하여 조정 하십시오.
- 에어브로, 절삭유, 오일미스트쿨러를추천하며, 칩을 잘 제거하고 가공시 발열과 발화에 주의 하십시오
- The edge of the flute precisely grinded. If you want to measure the tool, and to avoid damaging on the flutes, use non-contact measuring method.
- The parameters on the table is based on 4flutes. For using 6 or 8flutes, use the same RPM and raise up the feed up to 50% in stable milling condition.
- When milling workpiece, HRC over 60 hardened steel , reduce 20% of the RPM and feed compared to the same diameter.
- Use this table for your reference. Adjust the parameters depending on your machining geometry, machining purpose and CNC.
- If the table over the maximum RPM and feed of your machine, or found red heat on the material, adjust RPM and feed in the same proportion.
- Air blow or mist coolants are recommended and note for chip emission, heat, or ignition.



피삭재 Material		동 Copper C1100				합금강 / 프리하드강 Alloy Steels / Prehardened Steels NAK80/KP4M				고경도강 Hardened Steels STAVAX/SKD11				열처리 / 고경도강 Heat-treated steels / Hardened Steels SKD11 / SKD61			
경도 Hardness		40 ~ 45HRC								45 ~ 55HRC				55 ~ 62HRC			
외경 Outside Diameter	유효장 Effective Length	RPM	FEED	Ap Axial Depth	Ae Radial Depth	RPM	FEED	Ap Axial Depth	Ae Radial Depth	RPM	FEED	Ap Axial Depth	Ae Radial Depth	RPM	FEED	Ap Axial Depth	Ae Radial Depth
∅ 0.2	1	50,000	800	0.026	0.020	50,000	263	0.006	0.020	34,500	197	0.004	0.020	14,950	108	0.001	0.015
"	1.5	50,000	750	0.017	0.010	50,000	210	0.005	0.010	26,450	158	0.003	0.010	11,730	87	0.001	0.007
∅ 0.3	1	50,000	800	0.029	0.020	50,000	224	0.007	0.020	34,500	168	0.005	0.015	21,505	92	0.004	0.015
"	3	50,000	650	0.029	0.015	50,000	182	0.006	0.015	24,150	137	0.003	0.010	14,605	75	0.002	0.010
∅ 0.4	1	47,150	800	0.047	0.062	50,000	224	0.013	0.070	39,675	168	0.011	0.070	23,575	92	0.004	0.070
"	3	33,350	700	0.026	0.053	26,450	196	0.008	0.026	26,450	147	0.007	0.026	15,755	81	0.003	0.026
∅ 0.5	1	48,300	850	0.079	0.114	48,300	238	0.033	0.119	39,100	179	0.029	0.119	24,150	98	0.013	0.119
"	3	31,050	750	0.056	0.088	31,050	210	0.022	0.110	25,415	158	0.020	0.110	15,755	87	0.008	0.110
"	5	25,760	700	0.026	0.044	25,760	196	0.011	0.010	20,700	147	0.010	0.010	12,995	81	0.004	0.010
∅ 0.6	2	27,945	850	0.111	0.158	27,945	238	0.010	0.214	23,000	179	0.010	0.214	14,835	98	0.004	0.214
"	6	16,445	750	0.035	0.044	16,445	210	0.003	0.010	13,570	158	0.003	0.010	8,740	87	0.001	0.010
∅ 0.8	4	17,250	900	0.129	0.194	17,020	252	0.014	0.114	14,720	189	0.015	0.114	9,890	104	0.007	0.114
"	8	12,650	750	0.029	0.098	12,650	210	0.005	0.088	10,695	158	0.005	0.088	7,475	87	0.002	0.088
∅ 1	4	13,800	950	0.196	0.396	13,800	266	0.029	0.264	11,730	200	0.029	0.264	8,280	110	0.017	0.264
"	10	8,625	750	0.047	0.308	8,625	210	0.011	0.123	7,475	158	0.011	0.123	5,290	87	0.006	0.123
"	16	6,900	650	0.018	0.220	6,900	182	0.004	0.026	5,980	137	0.004	0.026	4,255	75	0.002	0.026
∅ 1.2	6	9,200	1,035	0.182	0.457	9,200	575	0.018	0.088	8,165	483	0.018	0.088	6,095	59	0.011	0.088
"	12	6,670	662	0.053	0.396	6,670	368	0.007	0.070	5,980	299	0.007	0.070	4,370	37	0.004	0.070
∅ 1.5	4	12,880	1,925	0.293	0.660	12,880	1,070	0.044	0.440	11,730	920	0.044	0.440	8,970	121	0.032	0.440
"	10	8,280	1,325	0.147	0.554	8,280	736	0.031	0.282	7,590	633	0.031	0.282	5,865	83	0.022	0.282
"	20	5,865	725	0.041	0.352	6,350	403	0.005	0.106	4,160	345	0.005	0.106	3,870	45	0.003	0.106
∅ 2	6	12,535	1,801	0.314	0.836	12,535	1,001	0.042	0.792	11,730	909	0.042	0.792	9,430	130	0.035	0.792
"	12	9,200	1,449	0.182	0.704	9,200	805	0.030	0.440	8,280	725	0.030	0.440	6,785	105	0.025	0.440
"	20	6,900	1,139	0.091	0.651	6,200	633	0.017	0.194	3,520	564	0.017	0.194	3,226	82	0.014	0.194
"	30	5,865	973	0.049	0.440	3,300	541	0.005	0.132	2,860	495	0.005	0.132	2,386	68	0.002	0.132
∅ 2.5	10	10,350	1,801	0.331	0.836	10,350	1,001	0.051	0.528	9,775	943	0.051	0.528	8,165	151	0.047	0.528
"	30	6,210	787	0.067	0.616	6,210	437	0.011	0.176	5,865	414	0.011	0.176	4,830	65	0.010	0.176
∅ 3	12	10,350	2,029	0.381	0.831	10,350	1,127	0.103	0.616	9,775	874	0.103	0.655	8,740	196	0.073	0.655
"	20	8,165	1,553	0.254	0.762	6,050	863	0.071	0.567	3,420	667	0.071	0.567	3,108	147	0.043	0.567
"	30	6,900	1,263	0.137	0.674	3,300	702	0.049	0.371	2,890	541	0.049	0.371	2,440	115	0.028	0.352
∅ 4	12	8,740	1,904	0.401	1.525	8,740	1,058	0.081	1.124	7,360	920	0.081	1.124	6,210	210	0.083	1.124
"	20	6,785	1,458	0.375	1.325	5,880	810	0.053	0.880	5,750	840	0.053	0.880	4,830	194	0.057	0.880
"	30	5,750	752	0.196	1.210	2,950	418	0.028	0.671	2,540	656	0.028	0.671	2,160	149	0.030	0.708
"	45	4,715	500	0.096	1.118	2,300	278	0.007	0.326	2,015	322	0.007	0.326	1,800	75	0.007	0.326
∅ 5	15	7,705	3,064	0.697	2.277	7,705	1,702	0.106	1.346	5,520	1,139	0.106	1.346	4,600	342	0.110	1.346
"	30	5,290	1,470	0.342	1.760	2,780	817	0.053	1.035	3,795	541	0.053	1.035	3,220	164	0.055	1.035
∅ 6	20	5,980	2,194	0.600	2.194	5,460	1,219	0.476	1.356	3,565	1,035	0.186	1.356	3,105	393	0.145	1.356
"	40	4,600	1,635	0.565	2.049	2,380	909	0.410	1.304	2,160	759	0.164	1.304	2,040	304	0.123	1.304
∅ 8	22	5,520	1,946	0.528	2.542	5,520	1,081	0.419	1.518	3,220	909	0.164	1.518	2,760	346	0.128	1.518
"	40	4,140	1,449	0.497	2.277	2,120	805	0.361	1.323	2,080	667	0.144	1.323	1,955	268	0.108	1.323
∅ 10	24	4,600	1,656	0.449	2.887	4,485	920	0.356	1.645	2,760	771	0.139	1.645	2,300	294	0.108	1.645
"	45	3,450	1,221	0.423	2.438	3,450	679	0.307	1.334	1,955	564	0.122	1.334	1,725	228	0.092	1.334
∅ 12	26	3,795	1,387	0.377	3.013	3,795	771	0.299	2.024	2,300	644	0.117	2.024	1,955	247	0.091	2.024
"	50	2,875	1,035	0.355	2.415	2,875	575	0.258	1.403	1,725	483	0.103	1.403	1,380	191	0.077	1.403
∅ 16	35	2,990	1,097	0.302	2.921	2,990	610	0.239	2.162	1,725	518	0.094	2.162	1,610	198	0.073	2.162

**절입량**  
Depth of Cut

Slotting  
• Ap : Axial Depth  
• D : Outside Diameter

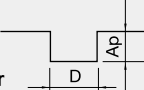

Side Milling

• Ap : Axial Depth  
• Ae : Radial Depth



경사진면절삭  
Inclined Cutting

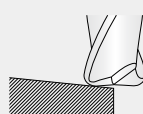

- HRC62 이상인 경우 같은 직경의 같은 비율로 20% DOWN 시켜주십시오.
- 유효장이 긴 경우에는 회전수와 이송 속도를 최대 30% 이하로 줄이십시오.
- Ae값 설정시 코너R 치수를 고려 해주십시오.
- 곡면 절삭시 날경의 코너R 보다 낮은 이동 PITCH를 설정 하십시오.
- 곡면 절삭시 안정적인 속도내 에서 피드를 최대 30%까지 UP 해주십시오.
- When milling workpiece HRC over 62, reduce 20% of the RPM and feed with the same diameter.
- If the effective length is long, reduce the RPM and feed maximum 30%.
- Consider the corner radius value when you set up the Ae value.
- For curved milling, set up the lower value of the pitch than the corner radius value of tool diameter.
- For curved milling, raise up the feed up to 30% in stable milling condition.

피삭재 Material		합금강 / 프리하든강 Alloy Steels / Prehardened Steels NAK80/KP4M				고경도강 Hardened Steels STAVAX/SKD11			
경도 Hardness		40 ~ 45HRC				45 ~ 55HRC			
외경 Outside Diameter	유효장 Effective Length	RPM	FEED	Ap Axial Depth	Ae Radial Depth	RPM	FEED	Ap Axial Depth	Ae Radial Depth
∅ 1	4	13,455	1,265	0.038	0.264	11,730	1,046	0.030	0.238
"	10	8,625	495	0.011	0.123	7,475	495	0.009	0.098
∅ 1.2	4	12,880	1,380	0.031	0.440	11,730	1,070	0.023	0.293
"	10	8,855	782	0.017	0.176	7,130	587	0.009	0.147
∅ 1.5	6	11,385	1,265	0.040	0.475	10,350	1,150	0.037	0.435
"	12	9,280	817	0.028	0.317	6,790	759	0.025	0.290
∅ 2	6	12,650	1,265	0.063	0.713	11,730	1,173	0.059	0.633
"	12	9,970	1,012	0.045	0.396	8,280	943	0.043	0.396
∅ 2.5	10	10,580	1,380	0.065	0.528	9,775	1,150	0.065	0.528
"	20	8,160	1,150	0.047	0.264	7,845	655	0.030	0.220
∅ 3	10	11,040	2,070	0.094	0.684	10,235	2,070	0.059	0.684
"	20	7,340	1,495	0.057	0.567	6,230	1,495	0.035	0.567
∅ 4	13	9,085	1,576	0.105	1.150	7,590	1,530	0.082	1.150
"	20	7,130	1,380	0.069	0.920	5,980	1,288	0.054	0.920
"	30	6,325	1,104	0.043	0.745	5,290	1,058	0.033	0.745
∅ 6	20	5,635	1,691	0.176	2.305	3,335	978	0.176	1.281
"	40	2,875	782	0.098	1.320	1,610	460	0.098	0.733
∅ 8	22	4,600	1,840	0.212	2.921	2,760	782	0.212	1.518
∅ 10	24	3,680	2,013	0.253	3.140	2,185	621	0.242	1.645
∅ 12	26	2,875	2,070	0.276	3.105	1,725	495	0.265	1.714

**절입량**  
Depth of Cut

Slotting

- Ap : Axial Depth
- D : Outside Diameter

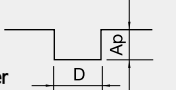

Side Milling

- Ap : Axial Depth
- Ae : Radial Depth

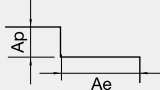

경사진면절삭  
Inclined Cutting

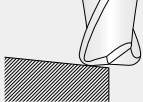

- HRC62 이상인 경우 같은 직경의 같은 비율로 20% DOWN 시켜주십시오.
- 유효장이 긴 경우에는 회전수와 이송 속도를 최대30% 이하로 줄이십시오.
- Ae값 설정시 코너R 치수를 고려해 주십시오.
- 곡면 절삭시 날경의 코너R 보다 낮은 이동 PITCH를 설정 하십시오.
- 곡면 절삭시 안정적인 속도 내에서 피드를 최대 30%까지 UP 해주십시오.
- When milling workpiece HRC over 62, reduce 20% of the RPM and feed with the same diameter.
- If the effective length is long, reduce the RPM and feed maximum 30%.
- Consider the corner radius value when you set up the Ae value.
- For curved milling, set up the lower value of the pitch than the corner radius value of tool diameter.
- For curved milling, raise up the feed up to 30% in stable milling condition.

## 홈절삭 Slotting

피삭재 Material	공구강/금형강 Tool steels / Mold steels SCM/HPM				합금강/프리하든강 Alloy Steels / Pre-hardened Steels NAK80 / KP4M				고경도강 Hardened Steels STAVAX / SKD11				열처리 / 고경도강 Heat-treated steels / Hardened Steels SKD11 / SKD61			
	경도 Hardness 30 ~ 40HRC				40 ~ 45HRC				45 ~ 55HRC				55 ~ 62HRC			
외경 Outside Diameter	RPM	FEED	Ap	Ae	RPM	FEED	Ap	Ae	RPM	FEED	Ap	Ae	RPM	FEED	Ap	Ae
			Axial Depth	Radial Depth			Axial Depth	Radial Depth			Axial Depth	Radial Depth			Axial Depth	Radial Depth
ø 0.4	50,000	1,065	0.020	0.32	45,000	507	0.020	0.32	40,000	221	0.008	0.20	33,000	187	0.008	0.20
ø 0.5	50,000	1,217	0.025	0.4	45,000	580	0.025	0.4	40,000	252	0.01	0.25	33,000	214	0.01	0.25
ø 0.6	50,000	1,369	0.03	0.48	45,000	652	0.03	0.48	40,000	284	0.012	0.3	30,000	241	0.012	0.3
ø 0.8	50,000	1,521	0.04	0.64	45,000	725	0.04	0.64	30,000	315	0.016	0.4	25,000	268	0.016	0.4
ø 1	48,000	3,773	0.05	0.8	38,000	1,797	0.05	0.8	25,500	781	0.02	0.5	20,500	664	0.02	0.5
ø 2	33,300	4,503	0.1	1.6	26,000	2,145	0.1	1.6	17,500	932	0.04	1	14,500	793	0.04	1
ø 3	21,800	4,564	0.15	2.4	17,300	2,174	0.15	2.4	11,500	945	0.06	1.5	9,500	803	0.06	1.5
ø 4	16,700	4,686	0.2	3.2	13,200	2,231	0.2	3.2	8,800	970	0.08	2	7,200	825	0.08	2
ø 5	15,700	4,990	0.25	4	12,500	2,376	0.25	4	8,300	1,033	0.1	2.5	6,400	878	0.1	2.5
ø 6	13,100	4,869	0.3	4.8	10,350	2,318	0.3	4.8	6,900	1,008	0.12	3	5,300	857	0.12	3
ø 8	9,880	4,443	0.4	6.4	7,800	2,116	0.4	6.4	5,200	920	0.16	4	4,000	782	0.16	4
ø 10	7,800	4,138	0.5	8	6,150	1,971	0.5	8	4,100	857	0.2	5	3,200	728	0.2	5
ø 12	6,650	4,138	0.6	9.6	5,250	1,971	0.6	9.6	3,500	857	0.24	6	2,650	728	0.24	6
ø 16	6,150	2,400	0.8	12.8	5,500	1,811	0.8	12.8	3,210	788	0.32	8	2,420	669	0.32	8

절입량  
Depth of Cut

~ 45HRC

45HRC ~

## 측면절삭 Side Cutting

피삭재 Material	공구강/금형강 Tool steels / Mold steels SCM/HPM				합금강/프리하든강 Alloy Steels / Pre-hardened Steels NAK80 / KP4M				고경도강 Hardened Steels STAVAX / SKD11				열처리 / 고경도강 Heat-treated steels / Hardened Steels SKD11 / SKD61			
	경도 Hardness 30 ~ 40HRC				40 ~ 45HRC				45 ~ 55HRC				55 ~ 62HRC			
외경 Outside Diameter	RPM	FEED	Ap	Ae	RPM	FEED	Ap	Ae	RPM	FEED	Ap	Ae	RPM	FEED	Ap	Ae
			Axial Depth	Radial Depth			Axial Depth	Radial Depth			Axial Depth	Radial Depth			Axial Depth	Radial Depth
ø 0.4	50,000	1,438	0.4	0.012	45,000	735	0.4	0.012	40,000	265	0.20	0.008	33,000	252	0.20	0.008
ø 0.5	50,000	1,643	0.5	0.015	45,000	841	0.5	0.015	40,000	302	0.25	0.01	33,000	289	0.25	0.01
ø 0.6	50,000	1,848	0.6	0.018	45,000	945	0.6	0.018	40,000	341	0.30	0.012	30,000	325	0.30	0.012
ø 0.8	50,000	2,053	0.8	0.024	40,000	1,051	0.8	0.024	30,000	378	0.40	0.016	25,000	362	0.40	0.016
ø 1	48,000	5,094	1	0.03	38,000	2,606	1	0.03	25,500	937	0.50	0.02	20,500	896	0.50	0.02
ø 2	33,300	6,079	2	0.06	26,000	3,110	2	0.06	17,500	1,118	1.00	0.04	14,500	1,071	1.00	0.04
ø 3	21,800	6,161	3	0.09	17,300	3,152	3	0.09	11,500	1,134	1.50	0.06	9,500	1,804	1.50	0.06
ø 4	16,700	6,326	4	0.12	13,200	3,235	4	0.12	8,800	1,164	2.00	0.08	7,200	1,114	2.00	0.08
ø 5	15,700	6,737	5	0.15	12,500	3,445	5	0.15	8,300	1,240	2.50	0.1	6,400	1,185	2.50	0.1
ø 6	13,100	6,573	6	0.18	10,350	3,361	6	0.18	6,900	1,210	3.00	0.12	5,300	1,157	3.00	0.12
ø 8	9,880	5,998	8	0.24	7,800	3,068	8	0.24	5,200	1,104	4.00	0.16	4,000	1,056	4.00	0.16
ø 10	7,800	5,586	10	0.3	6,150	2,858	10	0.3	4,100	1,028	5.00	0.2	3,200	983	5.00	0.2
ø 12	6,650	5,586	12	0.36	5,250	2,858	12	0.36	3,500	1,028	6.00	0.24	2,650	983	6.00	0.24
ø 16	6,280	3,240	16	0.48	5,100	2,626	16	0.48	3,410	946	8.00	0.32	2,440	903	8.00	0.32

절입량  
Depth of Cut

~ 45HRC

45HRC ~

- HRC62 이상인 경우 같은 직경의 같은 비율로 20% DOWN 시켜 주십시오.
- 유효장이 긴 경우에는 회전수와 이송 속도를 최대 30% 이하로 줄이십시오.
- 곡면 절삭시 날경의 코너R 보다 낮은 이동 PITCH를 설정 하십시오.
- 곡면 절삭시 안정적인 속도 내에서 피드를 최대 30% 까지 UP 해주십시오.
- 상기 절삭 조건표는 2날시 기준이며, 4날시 회전수는 유지하고, 피드는 안정적인 속도 내에서 최대 30%까지 UP 해주십시오.
- 홈 절삭시 날경의 코너R 대비 Ae 값을 설정 하십시오.
- 상기 절삭조건은 참고 수치이므로 실 가공시 가공 형상, 가공 목적, 적용 기계에 따라 조건변경 요망 합니다.
- 피삭재와 절삭 형상을 위한 적절한 클린트 사용과 가공시 발열, 발화에 주의 하십시오.

- When milling workpiece HRC over 62, reduce 20% of the RPM and feed with the same diameter.
- If the effective length is long, reduce the RPM and feed maximum 30%.
- For curved milling, set up the lower value of the pitch than the corner radius value of tool diameter.
- For curved milling, raise up the feed up to 30% in stable milling condition.
- The parameters on the table is based on 2flutes. For using 4flutes, use the same RPM and raise up the feed up to 50% in stable milling condition.
- For groove milling, set up the Ae value by considering of corner radius value.
- Use this table for your reference. Adjust the parameters depending on your machining geometry, machining purpose and CNC.
- Air blow or mist coolants are recommended and note for chip emission, heat, or ignition.

## 홈절삭 Slotting

피삭재 Material	구조용강 / 탄소강 / 회주철 Mild steels / Carbon Steels / Gray cast irons SS/SC/FC				공구강 / 금형강 Tool steels / Mold steels SCM/HPM				합금강 / 프리하든강 Alloy Steels / Pre-hardened Steels NAK80 / KP4M				고경도강 Hardened Steels STAVAX / SKD11			
	경도 Hardness	~30HRc				30 ~ 40HRc				40 ~ 45HRc				45 ~ 55HRc		
외경 Outside Diameter	RPM	FEED	Ap Axial Depth	Ae Radial Depth	RPM	FEED	Ap Axial Depth	Ae Radial Depth	RPM	FEED	Ap Axial Depth	Ae Radial Depth	RPM	FEED	Ap Axial Depth	Ae Radial Depth
ø 1	19,250	150	0.50	1	19,250	150	0.50	1	17,280	122	0.50	1	15,552	98	0.2	0.8
ø 1.5	12,845	230	0.75	2	12,800	220	0.75	2	11,520	178	0.75	2	10,368	142	0.3	1.2
ø 2	9,600	345	1.00	2	9,500	330	1.00	2	8,550	267	1.00	2	7,695	212	0.4	1.6
ø 3	6,400	490	1.50	3	6,400	440	1.50	3	5,800	360	1.50	3	5,300	240	0.6	2.4
ø 4	4,800	550	2.00	4	4,800	500	2.00	4	4,400	410	2.00	4	4,000	280	0.8	3.2
ø 5	3,850	600	2.50	5	3,800	550	2.50	5	3,420	446	2.50	5	3,078	356	1.0	4.0
ø 6	3,200	610	3.00	6	3,200	550	3.00	6	2,900	450	3.00	6	2,700	310	1.2	4.8
ø 8	2,400	650	4.00	8	2,400	590	4.00	8	2,200	480	4.00	8	2,000	330	1.6	6.4
ø 10	1,900	580	5.00	10	1,900	520	5.00	10	1,800	440	5.00	10	1,600	290	2.0	8.0
ø 12	1,600	540	6.00	12	1,600	480	6.00	12	1,500	400	6.00	12	1,300	260	2.4	9.6
ø 16	1,200	520	8.00	16	1,200	510	8.00	16	1,080	413	8.00	16	972	328	3.2	12.8
ø 20	960	510	10.00	20	950	500	10.00	20	855	405	10.00	20	770	324	4.0	16.0

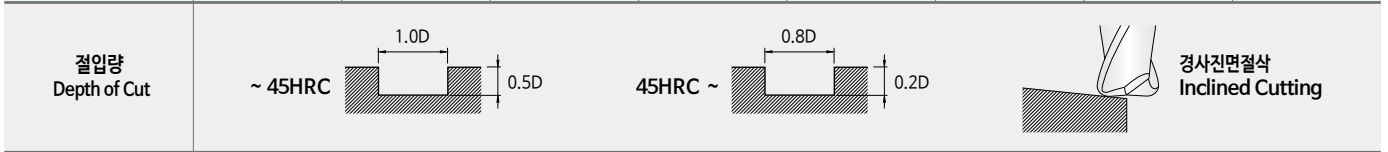

## 측면절삭 Side Cutting

피삭재 Material	구조용강 / 탄소강 / 회주철 Mild steels / Carbon Steels / Gray cast irons SS/SC/FC				공구강 / 금형강 Tool steels / Mold steels SCM/HPM				합금강 / 프리하든강 Alloy Steels / Pre-hardened Steels NAK80 / KP4M				고경도강 Hardened Steels STAVAX / SKD11			
	경도 Hardness	~30HRc				30 ~ 40HRc				40 ~ 45HRc				45 ~ 55HRc		
외경 Outside Diameter	RPM	FEED	Ap Axial Depth	Ae Radial Depth	RPM	FEED	Ap Axial Depth	Ae Radial Depth	RPM	FEED	Ap Axial Depth	Ae Radial Depth	RPM	FEED	Ap Axial Depth	Ae Radial Depth
ø 1	28,790	115	1	0.1	25,911	104	1	0.1	22,024	88	0.5	0.03	17,619	70	0.5	0.03
ø 1.5	19,200	403	2	0.2	17,280	363	2	0.2	14,688	308	0.8	0.045	11,750	247	0.8	0.045
ø 2	14,400	690	2	0.2	12,960	621	2	0.2	11,016	528	1.0	0.06	8,813	422	1.0	0.06
ø 3	9,600	860	3	0.3	9,600	770	3	0.3	8,500	610	1.5	0.09	7,400	460	1.5	0.09
ø 4	7,200	920	4	0.4	7,200	830	4	0.4	6,400	660	2.0	0.12	5,600	500	2.0	0.12
ø 5	5,750	960	5	0.5	5,175	864	5	0.5	4,399	734	2.5	0.15	3,519	588	2.5	0.15
ø 6	4,800	1,080	6	0.6	4,800	970	6	0.6	5,100	720	3.0	0.18	3,700	580	3.0	0.18
ø 8	3,600	1,150	8	0.8	3,600	1,040	8	0.8	4,200	750	4.0	0.24	2,800	630	4.0	0.24
ø 10	2,900	1,070	10	1.0	2,900	960	10	1.0	2,500	740	5.0	0.3	2,200	570	5.0	0.3
ø 12	2,400	1,000	12	1.2	2,400	900	12	1.2	2,100	700	6.0	0.36	1,900	550	6.0	0.36
ø 16	1,800	1,000	16	1.6	1,620	900	16	1.6	1,377	765	8.0	0.48	1,102	612	8.0	0.48
ø 20	1,440	930	20	2.0	1,296	837	20	2.0	1,102	711	10.0	0.6	881	569	10.0	0.6

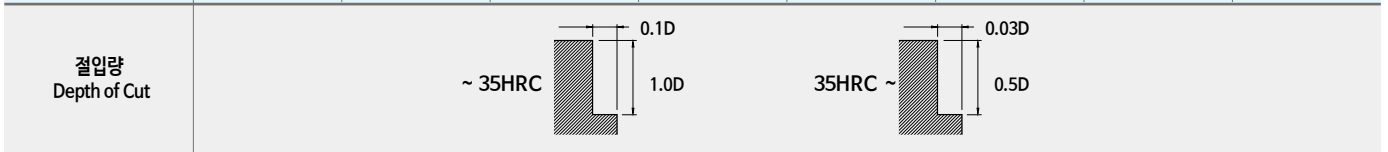

- 상기 조건표는 4날 기준이며, 6날 가공시 회전수는 유지하고, 안정적인 속도 내에서 피드를 최대 30%까지 UP 해주십시오.
- 유효장이 긴 경우에는 회전수와 이송 속도를 최대30% 이하로 줄이십시오.
- 측면 절삭시 코너R 참고하여 절삭 하시기 바랍니다.
- 곡면 절삭시 날경의 코너R 보다 낮은 이동 PITCH를 설정 하십시오.
- 곡면 절삭시 안정적인 속도 내에서 피드를 최대 30%까지 UP 해주십시오.
- 상기 절삭조건은 참고 수치이므로 실 가공시 가공 형상, 가공 목적, 적용 기계에 따라 조건변경 요망 합니다.
- 조건표가 기계의 최대 스피indle 속도를 초과하거나 버 및 적열 현상이 발생할 때 스피indle 속도와 이송 속도를 비례하여 조정 하십시오.
- 소재 및 가공 형상에 적합한 절삭유를 사용 하십시오.
- The parameters on the table is based on 4flutes. For using 6flutes, use the same RPM and raise up the feed up to 30% in stable milling condition.
- If the effective length is long, reduce the RPM and feed maximum 30%.
- For side milling, refer to the corner radius value.
- For curved milling, set up the lower value of the pitch than the corner radius value of tool diameter.
- For curved milling, raise up the feed up to 30% in stable milling condition.
- Use this table for your reference. Adjust the parameters depending on your machining geometry, machining purpose and CNC.
- If the table over the maximum RPM and feed of your machine, or found red heat on the material, adjust RPM and feed in the same proportion.
- Use suitable cutting oil for material and machining geometry.

피삭재 Material		구조용강 / 탄소강 / 회주철 Mild steels / Carbon Steels / Gray cast irons SS / SC / FC				공구강 / 금형강 Tool steels / Mold steels SCM / HPM				합금강 / 프리하드강 Alloy Steels / Pre-hardened Steels NAK80 / KP4M				고경도강 Hardened Steels STAVAX / SKD11			
경도 Hardness		~ 30HRc				30 ~ 40HRc				40 ~ 45HRc				45 ~ 55HRc			
외경 Outside Diameter	반경 Radius	RPM	FEED	Ap Axial Depth	Ae Radial Depth	RPM	FEED	Ap Axial Depth	Ae Radial Depth	RPM	FEED	Ap Axial Depth	Ae Radial Depth	RPM	FEED	Ap Axial Depth	Ae Radial Depth
ø 1	R0.2	42,840	7,871	0.02	0.4	35,700	6,845	0.02	0.4	29,750	5,738	0.015	0.3	22,500	4,835	0.015	0.3
ø 1.5	R0.5	40,800	8,073	0.02	0.6	34,000	7,020	0.02	0.6	25,500	5,738	0.023	0.5	18,900	4,837	0.023	0.5
ø 2	R0.5	27,540	8,477	0.03	0.8	22,950	7,371	0.03	0.8	20,400	5,739	0.03	0.6	14,400	4,839	0.03	0.6
ø 3	R0.5	18,360	9,082	0.05	1.2	15,300	7,898	0.05	1.2	13,600	5,740	0.045	0.9	9,900	4,841	0.045	0.9
ø 4	R0.5	16,320	10,091	0.06	1.6	13,600	8,775	0.06	1.6	11,050	5,741	0.06	1.2	8,100	4,843	0.06	1.2
"	R1.0	14,280	9,587	0.06	1.6	11,900	8,336	0.06	1.6	10,200	5,742	0.06	1.2	7,200	4,845	0.06	1.2
ø 5	R0.5	12,240	12,110	0.08	2.0	10,200	10,530	0.08	2.0	9,350	5,743	0.075	1.5	6,570	4,846	0.075	1.5
"	R1.0	11,220	11,100	0.08	2.0	9,350	9,653	0.08	2.0	8,160	5,743	0.075	1.5	5,760	4,848	0.075	1.5
ø 6	R0.3	11,118	13,320	0.09	2.4	9,265	11,583	0.09	2.4	8,500	5,744	0.09	1.8	5,850	4,850	0.09	1.8
"	R0.5	10,812	13,119	0.09	2.4	9,010	11,408	0.09	2.4	8,075	5,745	0.09	1.8	5,670	4,852	0.09	1.8
"	R1.0	12,907	12,715	0.09	2.4	10,756	11,057	0.09	2.4	7,650	5,747	0.09	1.8	5,220	4,854	0.09	1.8
"	R1.5	9,180	11,100	0.09	2.4	7,650	9,653	0.09	2.4	6,800	5,747	0.09	1.8	4,770	4,856	0.09	1.8
ø 8	R0.3	8,568	13,623	0.12	3.2	7,140	11,846	0.12	3.2	6,205	5,748	0.12	2.4	4,230	4,858	0.09	2.4
"	R0.5	8,364	13,119	0.12	3.2	6,970	11,408	0.12	3.2	6,035	5,748	0.12	2.4	4,140	4,859	0.12	2.4
"	R1.0	8,160	12,110	0.12	3.2	6,800	10,530	0.12	3.2	5,695	5,749	0.12	2.4	4,068	4,861	0.12	2.4
"	R2.0	7,140	11,100	0.12	3.2	5,950	9,653	0.12	3.2	5,100	5,750	0.12	2.4	3,600	4,863	0.12	2.4
ø 10	R0.3	6,620	13,098	0.15	4.0	5,517	11,390	0.15	4.0	4,814	5,751	0.15	3.0	3,398	4,865	0.15	3.0
"	R0.5	6,452	12,765	0.15	4.0	5,376	11,100	0.15	4.0	4,692	8,752	0.15	3.0	3,312	4,867	0.15	3.0
"	R1.0	6,283	12,432	0.15	4.0	5,236	10,811	0.15	4.0	4,570	5,753	0.15	3.0	3,226	4,869	0.15	3.0
"	R2.0	5,610	11,100	0.15	4.0	4,675	9,653	0.15	4.0	4,080	5,754	0.15	3.0	2,880	4,871	0.15	3.0
ø 12	R0.5	5,537	11,908	0.18	4.8	4,614	10,355	0.18	4.8	4,112	5,754	0.18	3.6	2,867	4,872	0.18	3.6
"	R1.0	5,396	11,605	0.18	4.8	4,497	10,091	0.18	4.8	4,008	5,755	0.18	3.6	2,795	4,874	0.18	3.6
"	R2.0	5,255	11,302	0.18	4.8	4,379	9,828	0.18	4.8	3,903	5,756	0.18	3.6	2,722	4,876	0.18	3.6
"	R3.0	4,692	10,091	0.18	4.8	3,910	8,775	0.18	4.8	3,485	5,757	0.18	3.6	2,430	4,878	0.18	3.6
ø 16	R1.0	4,092	10,479	0.24	6.4	3,410	9,112	0.24	6.4	3,009	5,758	0.24	4.8	2,124	4,880	0.24	4.8
"	R2.0	3,468	8,880	0.24	6.4	2,890	7,722	0.24	6.4	2,550	5,759	0.24	4.8	1,800	4,882	0.24	4.8

절입량  
Depth of Cut

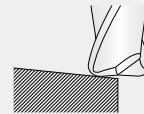
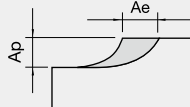

경사진면절삭  
Inclined Cutting

## ■ Coefficients respective of tool overhang

Type	Overhang	Revolution	Feed rate	Depth of Cut ap
Straight	L/D ≤ 5	100%	100%	100%
	L/D = 6	90%	80%	80%
	L/D = 7	80%	70%	70%
Taper neck	L/D = 6	100%	100%	100%
	L/D = 8	90%	80%	80%
	L/D ≥ 10	80%	70%	70%

- 상기 조건표는 4날 기준이며, 6날 가공시 회전수는 유지하고, 안정적인 속도 내에서 피드를 최대 30%까지 UP 해주십시오.
- 유효장이 긴 경우에는 회전수와 이송 속도를 최대30% 이하로 줄이십시오.
- 측면 절삭시 코너R 참고하여 절삭 하시기 바랍니다.
- 곡면 절삭시 날경의 코너R 보다 낮은 이동 PITCH를 설정 하십시오.
- 곡면 절삭시 안정적인 속도 내에서 피드를 최대 30%까지 UP 해주십시오.
- 상기 절삭조건은 참고 수치이므로 실 가공시 가공 형상, 가공 목적, 적용 기계에 따라 조건변경 요망 합니다.
- 적용 기계의 회전 속도가 부족한 경우에는 회전 속도와 이송 속도를 같은 비율로 줄여서 적용합니다.
- 유효장 길이가 긴 경우, 위 표와같이 RPM과 FEED를 낮춰주세요.
- 절입깊이가 얇은 경우, RPM과 FEED를 증가해주세요.
- 원활한 칩배출을 위하여 에어브로우나 오일 미스트를 추천합니다.
- The parameters on the table is based on 4flutes. For using 6flutes, use the same RPM and raise up the feed up to 30% in stable milling condition.
- If the effective length is long, reduce the RPM and feed maximum 30%.
- For side milling, refer to the corner radius value.
- For curved milling, set up the lower value of the pitch than the corner radius value of tool diameter.
- For curved milling, raise up the feed up to 30% in stable milling condition.
- Use this table for your reference. Adjust the parameters depending on your machining geometry, machining purpose and CNC.
- If the table over the maximum RPM and feed of your machine, adjust RPM and feed in the same proportion.
- If the effective length is long, refer to the table (Coefficients respective of tool overhang) and adjust the RPM and feed.
- If you use small value of Ap, raise up the RPM and feed.
- Air blow or oil mist is recommended for smooth chip emission.

## 홈절삭 Slotting

피삭재 Material	일반구조강 / 쾌삭강 Mild steels / Free cutting steel HP / SM				구조용강 / 탄소강 / 회주철 Structural steel / Carbon Steels / Gray cast iron SS / SC / FC				공구강 / 금형강 Tool steels / Mold steels SCM / HPM				합금강 / 프리하드강 / 스테인레스강 Alloy Steels / Pre-hardened Steels / Stainless Steel NAK80 / KP4M / SUS304 / SUS316			
	경도 Hardness ~ 200HB				~ 30HRC				30 ~ 40HRC				40 ~ 45HRC			
외경 Outside Diameter	RPM	FEED	Ap	Ae	RPM	FEED	Ap	Ae	RPM	FEED	Ap	Ae	RPM	FEED	Ap	Ae
			Axial Depth	Radial Depth			Axial Depth	Radial Depth			Axial Depth	Radial Depth			Axial Depth	Radial Depth
ø 4	4,000	211	0.25	4	4,000	430	2.8	4	3,800	200	2.8	4	2,800	110	2	4
ø 5	4,000	242	0.35	5	4,000	430	3.5	5	3,400	220	3.5	5	2,500	130	2.5	5
ø 6	3,600	281	0.40	6	3,600	430	4.2	6	3,000	240	4.2	6	2,300	150	3	6
ø 8	2,700	338	0.55	8	2,700	430	5.6	8	2,200	270	5.6	8	1,800	180	4	8
ø 10	2,200	380	0.70	10	2,200	430	7	10	1,800	290	7	10	1,400	185	5	10
ø 12	1,800	332	0.85	12	1,800	430	8.4	12	1,500	300	8.4	12	1,200	190	6	12
ø 16	1,400	305	1.10	16	1,400	430	11.2	16	1,100	310	11.2	16	900	200	8	16
ø 20	1,100	281	1.40	20	1,100	430	14	20	900	310	14	20	700	185	10	20

절입량  
Depth of Cut

~ 30HRC

30HRC ~

## 측면절삭 Side Cutting

피삭재 Material	일반구조강 / 쾌삭강 Mild steels / Free cutting steel HP / SM				구조용강 / 탄소강 / 회주철 Structural steel / Carbon Steels / Gray cast iron SS / SC / FC				공구강 / 금형강 Tool steels / Mold steels SCM / HPM				합금강 / 프리하드강 / 스테인레스강 Alloy Steels / Pre-hardened Steels / Stainless Steel NAK80 / KP4M / SUS304 / SUS316			
	경도 Hardness ~ 200HB				~ 30HRC				30 ~ 40HRC				40 ~ 45HRC			
외경 Outside Diameter	RPM	FEED	Ap	Ae	RPM	FEED	Ap	Ae	RPM	FEED	Ap	Ae	RPM	FEED	Ap	Ae
			Axial Depth	Radial Depth			Axial Depth	Radial Depth			Axial Depth	Radial Depth			Axial Depth	Radial Depth
ø 4	5,000	469	6	0.12	4,200	398	6	0.12	3,600	359	6	0.12	2,800	305	4	0.08
ø 5	5,000	538	7.5	0.15	4,200	457	7.5	0.15	3,200	411	7.5	0.15	2,400	350	5	0.10
ø 6	4,200	625	9	0.18	3,600	531	9	0.18	2,800	478	9	0.18	2,100	406	6	0.12
ø 8	3,200	750	12	0.24	2,700	638	12	0.24	2,100	574	12	0.24	1,600	488	8	0.16
ø 10	2,600	844	15	0.3	2,200	717	15	0.3	1,600	645	15	0.3	1,300	549	10	0.20
ø 12	2,100	738	18	0.36	1,800	627	18	0.36	1,400	564	18	0.36	1,100	480	12	0.24
ø 16	1,600	678	21	0.48	1,400	576	21	0.48	1,000	519	21	0.48	800	441	16	0.32
ø 20	1,300	625	30	0.6	1,100	531	30	0.6	800	478	30	0.6	640	406	20	0.40

절입량  
Depth of Cut

~ 38HRC

38HRC ~

- 가능한 공구 길이 측정시 유압식 측정이 아닌 레이저식 도구 세터를 사용 하십시오.
- 가공 진입시 가능한 피삭재 밖에서 진입 하십시오.
- 유효장이가 긴 경우에는 회전수와 이송속도를 최대 30% 이하로 줄이십시오.
- 상기 절삭조건은 참고 수치이므로 실 가공시 가공 형상, 가공 목적, 적용 기계에 따라 조건변경 요망 합니다.
- 공작기계와 가공물의 강성이 없는 경우, 진동이 발생할시 조건표에 회전속도와 이송속도를 같은 비율로 줄여서 적용 합니다.
- 피삭재와 가공 모양에 따라 적절한 콜런트를 사용 하십시오.
- 스테인레스, 내열합금강 등의 절단 가공시 수용성 절삭유가 가장 효과적 입니다.
- Use laser tool measurement instead of hydraulic measurement when measuring tool length as possible.
- When entering the tool to the workpiece, enter the tool from outside to the workpiece.
- If the effective length is long, reduce the RPM and feed maximum 30%.
- Use this table for your reference. Adjust the parameters depending on your machining geometry, machining purpose and CNC.
- In case of workpiece and machine do not have enough rigidity and make vibration, reduce the RPM and feed in same proportion.
- Depending on the workpiece and shape, use adequate coolant.
- For stainless and heat resistant alloy, water-soluble oil is the most effective.

## 홈절삭 Slotting

피삭재 Material	일반구조강 / 쾌삭강 Mild steels / Free cutting steel HP/SM				구조용강 / 탄소강 / 회주철 Structural steel / Carbon Steels / Gray cast iron SS/SC/FC				공구강 / 금형강 Tool steels / Mold steels SCM/HPM				합금강 / 프리하드강 / 스테인레스강 Alloy Steels / Pre-hardened Steels / Stainless Steel NAK80 / KP4M / SUS304 / SUS316			
	경도 Hardness		~ 200HB		~ 30HRc		~ 30HRc		30 ~ 40HRc		30 ~ 40HRc		40 ~ 45HRc			
외경 Outside Diameter	RPM	FEED	Ap	Ae	RPM	FEED	Ap	Ae	RPM	FEED	Ap	Ae	RPM	FEED	Ap	Ae
			Axial Depth	Radial Depth			Axial Depth	Radial Depth			Axial Depth	Radial Depth			Axial Depth	Radial Depth
ø 4	4,600	264	3.2	4	4,400	224	3.2	4	3,200	179	3.2	4	2,800	117	2.4	4
ø 5	4,600	302	4	5	4,000	257	4	5	2,900	206	4	5	2,500	134	3.0	5
ø 6	4,100	352	4.8	6	3,500	299	4.8	6	2,700	239	4.8	6	2,200	155	3.6	6
ø 8	3,100	422	6.4	8	2,500	359	6.4	8	2,100	287	6.4	8	1,700	186	4.8	8
ø 10	2,500	475	8	10	2,100	403	8	10	1,600	323	8	10	1,300	210	6.0	10
ø 12	2,100	415	9.6	12	1,700	353	9.6	12	1,400	282	9.6	12	1,100	183	7.2	12
ø 16	1,600	381	12.8	16	1,300	324	12.8	16	1,000	259	12.8	16	800	169	9.6	16
ø 20	1,300	352	16	20	1,000	299	16	20	800	239	16	20	650	155	12	20

절입량  
Depth of Cut

~ 38HRC

38HRC ~

## 측면절삭 Side Cutting

피삭재 Material	일반구조강 / 쾌삭강 Mild steels / Free cutting steel HP/SM				구조용강 / 탄소강 / 회주철 Structural steel / Carbon Steels / Gray cast iron SS/SC/FC				공구강 / 금형강 Tool steels / Mold steels SCM/HPM				합금강 / 프리하드강 / 스테인레스강 Alloy Steels / Pre-hardened Steels / Stainless Steel NAK80 / KP4M / SUS304 / SUS316			
	경도 Hardness		~ 200HB		~ 30HRc		~ 30HRc		30 ~ 40HRc		30 ~ 40HRc		40 ~ 45HRc			
외경 Outside Diameter	RPM	FEED	Ap	Ae	RPM	FEED	Ap	Ae	RPM	FEED	Ap	Ae	RPM	FEED	Ap	Ae
			Axial Depth	Radial Depth			Axial Depth	Radial Depth			Axial Depth	Radial Depth			Axial Depth	Radial Depth
ø 4	5,800	539	6	2	4,800	458	6	2	4,800	458	6	2	3,200	351	4	1.6
ø 5	5,800	318	7.5	2.5	4,800	525	7.5	2.5	4,800	525	7.5	2.5	2,800	402	5	2.0
ø 6	4,800	719	9	3	4,200	611	9	3	4,200	611	9	3	2,400	467	6	2.4
ø 8	3,700	863	12	4	3,100	733	12	4	3,100	733	12	4	1,800	561	8	3.2
ø 10	3,000	970	15	5	2,500	825	15	5	2,500	825	15	5	1,500	631	10	4.0
ø 12	2,400	848	18	6	2,100	721	18	6	2,100	721	18	6	1,300	551	12	4.8
ø 16	1,850	780	24	8	1,600	663	24	8	1,600	663	24	8	1,000	507	16	6.4
ø 20	1,500	719	30	10	1,300	611	30	10	1,300	611	30	10	750	467	20	8.0

절입량  
Depth of Cut

~ 38HRC

38HRC ~

- 가능한 공구 길이 측정시 유압식 측정이 아닌 레이저식 도구 세터를 사용 하십시오.
- 가공 진입시 가능한 피삭재 밖에서 진입 하십시오.
- 유효장이 긴 경우에는 회전수와 이송속도를 최대 30% 이하로 줄이십시오.
- 상기 절삭조건은 참고 수치이므로 실 가공시 가공 형상, 가공 목적, 적용 기계에 따라 조건변경 요망 합니다.
- 공작기계와 가공물의 강성이 없는 경우, 진동이 발생할시 조건표에 회전속도와 이송속도를 같은 비율로 줄여서 적용 합니다.
- 피삭재와 가공 모양에 따라 적절한 콜러트를 사용 하십시오.
- 스테인레스, 내열합금강 등의 절단 가공시 수용성 절삭유가 가장 효과적 입니다.
- Use laser tool measurement instead of hydraulic measurement when measuring tool length as possible.
- When entering the tool to the workpiece, enter the tool from outside to the workpiece.
- If the effective length is long, reduce the RPM and feed maximum 30%.
- Use this table for your reference. Adjust the parameters depending on your machining geometry, machining purpose and CNC.
- In case of workpiece and machine do not have enough rigidity and make vibration, reduce the RPM and feed in same proportion.
- Depending on the workpiece and shape, use adequate coolant.
- For stainless and heat resistant alloy, water-soluble oil is the most effective.

피삭재 Material		공구강 / 금형강 Tool steels / Mold steels SCM / HPM				합금강 / 프리하든강 Alloy Steels / Pre-hardened Steels NAK80 / KP4M				고경도강 Hardened Steels STAVX / SKD11			
경도 Hardness		30 ~ 40HRc				40 ~ 45HRc				45 ~ 55HRc			
반경 Corner Radius	유효장 Effective Length	RPM	FEED	Ap Axial Depth	Ae Radial Depth	RPM	FEED	Ap Axial Depth	Ae Radial Depth	RPM	FEED	Ap Axial Depth	Ae Radial Depth
R0.1	0.5	54,000	430	0.010	0.010	48,000	350	0.006	0.007	48,000	280	0.006	0.007
"	1	54,000	380	0.008	0.008	48,000	330	0.005	0.005	48,000	250	0.005	0.005
"	1.5	47,000	320	0.006	0.006	47,000	250	0.004	0.004	47,000	200	0.004	0.004
"	2	42,000	290	0.004	0.004	42,000	200	0.003	0.003	42,000	200	0.003	0.003
R0.15	1	54,000	640	0.014	0.015	48,000	480	0.010	0.010	41,000	370	0.009	0.010
"	2	49,000	530	0.011	0.011	43,000	370	0.008	0.008	37,000	270	0.008	0.008
"	3	43,000	460	0.009	0.010	38,000	320	0.007	0.006	32,000	240	0.006	0.006
"	4	37,000	300	0.004	0.006	28,000	200	0.003	0.004	24,000	160	0.003	0.004
R0.2	1	54,000	870	0.023	0.036	48,000	660	0.018	0.024	37,000	450	0.015	0.024
"	2	54,000	790	0.022	0.036	48,000	590	0.018	0.024	37,000	400	0.015	0.020
"	3	50,000	660	0.017	0.018	41,000	420	0.012	0.012	31,000	280	0.011	0.012
"	4	50,000	640	0.012	0.018	38,000	400	0.009	0.012	30,000	270	0.009	0.012
"	5	37,000	410	0.009	0.018	29,000	330	0.008	0.012	26,000	260	0.007	0.012
"	6	37,000	360	0.006	0.010	29,000	260	0.005	0.006	26,000	200	0.004	0.006
"	8	27,000	200	0.003	0.006	27,000	170	0.003	0.003	23,000	150	0.002	0.003
R0.25	1	57,000	1,380	0.029	0.054	42,000	830	0.023	0.036	32,000	550	0.018	0.036
"	2	57,000	1,250	0.028	0.054	42,000	750	0.022	0.036	32,000	500	0.018	0.036
"	3	55,000	1,010	0.021	0.036	38,000	580	0.017	0.024	31,000	400	0.014	0.024
"	4	55,000	1,010	0.021	0.036	38,000	580	0.017	0.024	31,000	400	0.014	0.024
"	5	48,000	800	0.016	0.018	33,000	480	0.012	0.012	30,000	390	0.009	0.012
"	6	36,000	610	0.009	0.018	28,000	400	0.008	0.012	27,000	330	0.005	0.012
"	8	36,000	590	0.009	0.018	28,000	400	0.008	0.012	27,000	330	0.005	0.012
"	10	36,000	460	0.009	0.018	28,000	400	0.008	0.012	27,000	330	0.005	0.012
"	12	24,000	280	0.004	0.010	26,000	280	0.004	0.006	24,000	280	0.002	0.006
R0.3	1	57,000	1,670	0.035	0.144	37,000	840	0.027	0.096	27,000	540	0.023	0.096
"	2	57,000	1,540	0.034	0.144	37,000	770	0.027	0.096	27,000	500	0.021	0.096
"	3	57,000	1,540	0.034	0.144	37,000	770	0.027	0.096	27,000	500	0.021	0.096
"	4	54,000	1,130	0.026	0.108	35,000	600	0.020	0.072	26,000	380	0.016	0.072
"	5	46,000	960	0.019	0.072	28,000	460	0.016	0.048	26,000	370	0.012	0.048
"	6	46,000	960	0.019	0.072	28,000	460	0.016	0.048	26,000	370	0.012	0.048
"	8	30,000	570	0.010	0.054	24,000	400	0.009	0.036	23,000	320	0.006	0.036
"	10	30,000	490	0.007	0.036	24,000	330	0.006	0.024	23,000	290	0.004	0.024
"	12	30,000	490	0.007	0.036	24,000	330	0.006	0.024	23,000	290	0.004	0.024
"	14	20,000	300	0.004	0.027	22,000	300	0.004	0.018	20,000	250	0.002	0.018
R0.35	2	56,000	1,800	0.050	0.162	35,000	740	0.039	0.108	27,000	500	0.031	0.108
"	4	54,500	1,500	0.045	0.063	33,000	600	0.035	0.096	26,500	410	0.029	0.096
"	8	32,000	800	0.019	0.072	12,215	420	0.020	0.048	22,500	355	0.012	0.048
"	10	26,500	540	0.017	0.063	22,500	380	0.014	0.042	21,500	330	0.011	0.042
"	12	23,000	420	0.017	0.063	21,500	380	0.012	0.032	21,500	320	0.010	0.042
R0.4	2	55,000	2,060	0.063	0.180	33,000	710	0.050	0.120	27,000	500	0.041	0.120
"	4	55,000	1,860	0.063	0.180	31,000	600	0.050	0.120	27,000	440	0.041	0.120
"	6	47,000	1,410	0.038	0.108	28,000	570	0.030	0.072	22,000	390	0.024	0.072
"	8	34,000	1,040	0.027	0.090	21,000	430	0.021	0.060	22,000	390	0.018	0.060
"	10	23,000	600	0.027	0.090	21,000	430	0.021	0.060	20,000	370	0.017	0.060
"	12	16,000	350	0.027	0.090	19,000	430	0.018	0.040	20,000	350	0.016	0.060
R0.45	6	50,500	1,900	0.067	0.190	32,000	685	0.054	0.130	24,500	460	0.043	0.180
R0.5	2	46,000	2,000	0.072	0.360	32,000	770	0.057	0.240	22,000	480	0.045	0.240
"	3	46,000	2,000	0.072	0.360	32,000	770	0.057	0.240	22,000	480	0.045	0.240
"	4	46,000	2,000	0.071	0.360	32,000	770	0.057	0.240	22,000	480	0.045	0.240
"	5	46,000	2,000	0.071	0.360	32,000	770	0.057	0.240	22,000	480	0.045	0.240
"	6	39,000	1,500	0.071	0.180	26,000	760	0.055	0.120	17,600	480	0.045	0.120
"	8	39,000	1,500	0.043	0.180	26,000	760	0.034	0.120	17,600	480	0.027	0.120
"	10	29,000	1,110	0.028	0.090	17,600	530	0.024	0.060	16,500	420	0.018	0.060
"	12	18,700	660	0.027	0.090	17,600	530	0.024	0.060	16,500	420	0.018	0.060
"	14	18,700	640	0.022	0.090	15,400	440	0.018	0.060	14,300	360	0.014	0.060
"	16	18,700	640	0.022	0.090	15,400	440	0.018	0.060	14,300	360	0.014	0.060
"	18	18,700	540	0.017	0.090	14,300	440	0.013	0.060	13,200	360	0.009	0.060
"	20	18,700	540	0.017	0.054	14,300	360	0.013	0.036	13,200	300	0.009	0.036
"	22	18,700	540	0.017	0.054	14,300	360	0.013	0.036	13,200	300	0.009	0.036
"	25	18,700	540	0.016	0.052	14,300	360	0.013	0.030	13,200	300	0.009	0.030
R0.6	4	38,000	2,000	0.085	0.360	26,000	770	0.068	0.240	18,200	480	0.054	0.240
"	6	38,000	2,000	0.085	0.360	26,000	770	0.068	0.240	18,200	480	0.054	0.240
"	8	32,000	1,490	0.084	0.360	21,000	700	0.067	0.240	15,100	440	0.054	0.240
"	10	24,000	1,080	0.036	0.180	16,400	530	0.027	0.120	15,100	420	0.022	0.120
"	12	24,000	1,080	0.036	0.180	15,300	530	0.027	0.120	14,100	420	0.022	0.120
"	16	15,400	580	0.024	0.144	13,100	460	0.019	0.096	11,900	380	0.016	0.096
"	20	15,400	580	0.017	0.090	12,100	380	0.013	0.060	11,000	320	0.009	0.060
"	24	15,400	580	0.010	0.060	11,100	320	0.009	0.040	9,800	290	0.007	0.040



피삭재 Material		공구강 / 금형강 Tool steels / Mold steels SCM/HPM				합금강 / 프리하드강 Alloy Steels / Pre-hardened Steels NAK80 / KP4M				고경도강 Hardened Steels STAVX / SKD11			
경도 Hardness		30 ~ 40HRc				40 ~ 45HRc				45 ~ 55HRc			
반경 Corner Radius	유효장 Effective Length	RPM	FEED	Ap	Ae	RPM	FEED	Ap	Ae	RPM	FEED	Ap	Ae
				Axial Depth	Radial Depth			Ap	Radial Depth			Ap	Radial Depth
R 0.7	6	28,000	1,470	0.099	0.270	17,600	680	0.076	0.180	13,600	440	0.063	0.180
"	8	28,000	1,470	0.099	0.270	17,600	680	0.079	0.180	13,600	440	0.063	0.180
"	12	19,800	1,080	0.042	0.270	13,800	530	0.033	0.180	13,600	420	0.027	0.180
"	16	13,200	620	0.033	0.180	13,100	480	0.027	0.120	11,900	390	0.021	0.120
R 0.75	3	30,000	2,200	0.171	0.324	21,000	1060	0.137	0.216	14,800	660	0.110	0.216
"	4	30,000	2,200	0.171	0.324	21,000	1060	0.137	0.216	14,800	660	0.110	0.216
"	6	30,000	1,980	0.147	0.324	21,000	940	0.117	0.216	14,800	580	0.090	0.216
"	8	26,000	1,500	0.106	0.270	16,300	700	0.084	0.180	12,100	450	0.069	0.180
"	10	26,000	1,500	0.106	0.270	16,300	700	0.084	0.180	12,100	450	0.069	0.180
"	12	26,000	1,500	0.106	0.270	16,300	700	0.084	0.180	12,100	450	0.069	0.180
"	14	18,700	1,100	0.045	0.180	12,600	530	0.036	0.120	12,100	440	0.027	0.120
"	16	12,100	620	0.036	0.180	12,400	480	0.027	0.120	11,600	390	0.022	0.120
"	18	12,100	620	0.036	0.180	12,400	480	0.027	0.120	11,600	390	0.022	0.120
"	20	12,100	620	0.019	0.090	12,400	480	0.016	0.060	11,600	390	0.012	0.060
"	22	12,100	620	0.019	0.090	12,400	480	0.016	0.060	11,000	390	0.012	0.060
"	25	11,000	500	0.019	0.090	12,400	440	0.016	0.060	11,000	390	0.012	0.060
"	30	10,700	450	0.019	0.090	10,900	400	0.016	0.060	11,000	390	0.012	0.060
R 0.8	6	27,040	2,600	0.220	0.580	18,900	1200	0.180	0.390	1,650	760	0.150	0.390
"	8	26,000	1,970	0.157	0.324	18,900	940	0.126	0.216	13,800	580	0.102	0.216
"	12	25,000	1,490	0.112	0.180	15,100	700	0.090	0.120	11,500	440	0.072	0.120
"	16	17,600	110	0.046	0.144	12,300	530	0.036	0.096	11,400	440	0.030	0.096
"	20	11,000	630	0.036	0.090	11,500	480	0.030	0.060	10,900	400	0.024	0.060
R 0.9	6	32,000	2,600	0.230	0.300	18,400	1200	0.185	0.320	18,400	738	0.150	0.320
"	8	26,000	1,950	0.165	0.270	16,300	930	0.132	0.240	13,800	570	0.108	0.240
"	12	21,000	1,480	0.120	0.270	13,800	700	0.094	0.180	10,300	440	0.077	0.180
"	16	15,400	1,080	0.048	0.180	10,800	530	0.039	0.120	9,900	420	0.031	0.120
"	20	10,500	630	0.039	0.090	10,200	480	0.031	0.060	9,700	400	0.025	0.060
R 1	4	22,000	2,140	0.232	0.540	18,500	1260	0.185	0.360	13,200	960	0.150	0.360
"	6	22,000	2,140	0.232	0.540	18,500	1260	0.185	0.360	13,200	960	0.150	0.360
"	8	22,000	1,920	0.185	0.360	18,500	1120	0.147	0.240	13,200	870	0.120	0.240
"	10	22,000	1,920	0.185	0.360	18,500	1120	0.147	0.240	13,200	870	0.120	0.240
"	12	18,700	1,470	0.166	0.360	16,000	990	0.133	0.240	11,700	780	0.107	0.240
"	14	18,700	1,470	0.166	0.360	16,000	990	0.133	0.240	11,700	780	0.107	0.240
"	16	18,700	1,470	0.148	0.360	16,000	990	0.118	0.240	11,700	780	0.090	0.240
"	18	14,300	1,070	0.093	0.180	14,700	580	0.074	0.120	11,600	580	0.061	0.120
"	20	14,300	1,070	0.093	0.180	14,700	580	0.074	0.120	11,600	580	0.061	0.120
"	22	9,500	630	0.074	0.180	10,600	450	0.058	0.120	10,200	450	0.045	0.120
"	25	9,500	630	0.074	0.180	10,600	450	0.058	0.120	10,200	450	0.045	0.120
"	30	9,500	530	0.033	0.090	10,600	450	0.026	0.060	10,200	380	0.021	0.060
R 1.25	8	18,400	2,400	0.232	0.360	14,500	1400	0.185	0.240	9,700	1080	0.150	0.240
"	10	18,400	2,400	0.232	0.360	14,500	1400	0.185	0.240	9,700	1080	0.150	0.240
"	16	16,100	1,810	0.208	0.360	13,500	1230	0.166	0.240	8,400	980	0.135	0.240
"	20	11,500	1,330	0.116	0.180	10,200	950	0.093	0.120	8,400	980	0.074	0.120
"	25	6,900	770	0.093	0.180	8,400	540	0.074	0.120	8,400	560	0.061	0.120
"	30	6,900	770	0.040	0.090	8,400	540	0.033	0.060	8,400	560	0.026	0.060
R 1.5	6	15,000	2,890	0.278	0.540	12,900	1680	0.222	0.360	9,200	1300	0.180	0.360
"	8	15,000	2,890	0.278	0.540	12,900	1680	0.222	0.360	9,200	1300	0.180	0.360
"	10	15,000	2,600	0.278	0.540	12,900	1680	0.222	0.360	9,200	1300	0.180	0.360
"	12	15,000	2,600	0.278	0.540	12,900	1510	0.222	0.360	9,200	1170	0.180	0.360
"	16	12,700	1,970	0.029	0.504	11,300	1330	0.166	0.360	8,100	1040	0.135	0.360
"	20	12,700	1,970	0.029	0.504	11,300	1330	0.166	0.360	8,100	1040	0.135	0.360
"	25	10,100	1,450	0.139	0.270	8,800	1040	0.111	0.180	8,100	1040	0.090	0.180
"	30	10,100	1,450	0.139	0.270	8,800	780	0.111	0.180	8,100	780	0.090	0.180
"	35	6,600	840	0.073	0.270	7,900	620	0.055	0.180	7,500	650	0.045	0.180
"	40	6,600	840	0.073	0.270	7,900	620	0.055	0.180	7,500	520	0.045	0.180
"	45	4,500	500	0.040	0.270	6,200	500	0.035	0.180	7,000	450	0.023	0.180
R 2	8	11,500	2,710	0.370	0.900	9,700	1560	0.297	0.600	6,800	1210	0.241	0.600
"	10	11,500	2,710	0.370	0.900	9,700	1560	0.297	0.600	6,800	1210	0.241	0.600
"	12	11,500	2,710	0.390	0.900	9,700	1560	0.297	0.600	6,800	1210	0.241	0.600
"	16	11,500	2,710	0.390	0.900	9,700	1560	0.297	0.600	6,800	1210	0.241	0.600
"	20	11,500	2,710	0.390	0.900	9,700	1560	0.297	0.600	6,800	1210	0.241	0.600
"	25	10,300	1,850	0.279	0.540	8,400	1250	0.223	0.360	6,000	980	0.180	0.360
"	30	10,300	1,850	0.279	0.540	8,400	1250	0.223	0.360	6,000	980	0.180	0.360
"	35	7,500	1,360	0.185	0.540	6,600	950	0.148	0.360	6,000	700	0.120	0.360
"	40	7,500	1,360	0.185	0.540	6,600	950	0.148	0.360	6,000	700	0.120	0.360
"	45	5,000	780	0.093	0.360	5,900	470	0.074	0.240	5,600	490	0.060	0.240

피삭재 Material		공구강/금형강 Tool steels / Mold steels SCM/HPM				합금강/프리하든강 Alloy Steels / Pre-hardened Steels NAK80 / KP4M				고경도강 Hardened Steels STAVX / SKD11			
경도 Hardness		30 ~ 40Hrc				40 ~ 45Hrc				45 ~ 55Hrc			
반경 Corner Radius	유효장 Effective Length	RPM	FEED	Ap Axial Depth	Ae Radial Depth	RPM	FEED	Ap Axial Depth	Ae Radial Depth	RPM	FEED	Ap Axial Depth	Ae Radial Depth
R 2.5	16	9,600	2,590	0.406	0.900	7,800	1350	0.324	0.800	5,600	1050	0.252	0.800
"	20	9,600	2,100	0.406	0.900	7,800	1240	0.324	0.600	5,600	950	0.252	0.600
"	25	9,600	2,100	0.406	0.900	7,800	1240	0.324	0.600	5,600	950	0.252	0.600
"	30	8,200	1,320	0.305	0.900	7,800	760	0.243	0.600	4,800	600	0.197	0.600
"	40	7,000	830	0.230	0.900	7,800	470	0.200	0.600	4,300	380	0.154	0.600
R 3	15	8,000	2,530	0.555	1.800	7,400	1670	0.443	1.200	5,200	1300	0.360	1.200
R 4	25	9,000	2,400	0.600	1.500	7,200	1200	0.500	1.000	5,200	920	0.350	1.000
R 5	30	7,800	1,300	0.300	0.900	6,800	720	0.230	0.600	4,600	570	0.190	0.570
R 6	30	7,410	1,235	0.285	0.855	6,350	684	0.210	0.570	4,370	541	0.181	0.550

**절입량**  
Depth of Cut

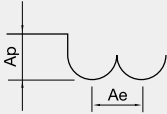

Ap : Axial Depth 축방향의절입깊이(mm)  
 Ae : Radial Depth 반경방향의절입깊이(mm)  
 D : Outside Diameter 외경(mm)  
 n : Speed 회전속도 (min<sup>-1</sup>)  
 Vf : Feed 이송속도 (mm/min)

- HRC52 이상 고경도강 가공시 같은 직경의 같은 비율로 20% DOWN 시켜주십시오.
- 유효장이 없는 절삭조건은 같은 직경에 더 짧은 유효장 대비 같은 비율로 DOWN 해주십시오.
- 유효장 길이가 긴 경우, RPM과 FEED를 동일 비율로 낮춰주세요.
- 에어브로 혹은 미스트 쿨러트를 추천하며, 동가공시 습식 쿨러트 추천 합니다.
- 상기 절삭조건은 참고 수치이므로 실 가공시 가공 형상, 가공 목적, 적용 기계에 따라 조건변경 요망 합니다.
- 진동이 적고 강성이 좋은 공작기계 사용 요망 합니다 (Ø1이하 사용시 진동 허용 관리 5µm이내 일것.)
- 칩 제거 주의 및 가공시 발열, 발화에 주의 하십시오.
- When milling workpiece HRC over 52 hardened steel , reduce 20% of the RPM and feed compared to the same diameter.
- If the effective length of your tool does not show above the table, use the shorten effective length of parameter and reduce the parameters in the same proportion.
- In case of long effective length, reduce the RPM and feed in same proportion.
- Air blow or oil mist is recommended for smooth chip emission, and dry milling is recommended for copper material.
- Use this table for your reference. Adjust the parameters depending on your machining geometry, machining purpose and CNC.
- Use a machine with low vibration and good rigidity (Ø1 or less, the vibration tolerance management should be within 5µm).
- During the chip evacuation, note for heat and ignition.

피삭재 Material	공구강 / 금형강 Tool steels / Mold steels SCM/HPM				합금강/프리하든강 Alloy Steels / Pre-hardened Steels NAK80 / KP4M				고경도강 Hardened Steels STAVX / SKD11			
경도 Hardness	30 ~ 40HRc				40 ~ 45HRc				45 ~ 55HRc			
반경 Corner Radius	RPM	FEED	Ap Axial Depth	Ae Radial Depth	RPM	FEED	Ap Axial Depth	Ae Radial Depth	RPM	FEED	Ap Axial Depth	Ae Radial Depth
R 0.15	35,100	650	0.100	0.015	31,200	478	0.093	0.015	25,740	364	0.088	0.015
R 0.2	35,100	765	0.200	0.020	31,200	582	0.186	0.020	25,740	468	0.176	0.020
R 0.25	35,100	1165	0.300	0.025	31,200	915	0.279	0.025	25,740	728	0.264	0.025
R 0.3	35,100	1498	0.350	0.030	31,200	1186	0.326	0.030	23,400	832	0.308	0.030
R 0.35	31,200	1830	0.400	0.040	23,400	1227	0.372	0.040	19,500	962	0.352	0.040
R0.4	30,420	2163	0.450	0.045	21,684	1373	0.419	0.045	17,706	1066	0.396	0.045
R0.5	29,640	2371	0.450	0.050	19,890	1498	0.419	0.050	15,990	1118	0.396	0.050
R0.75	24,960	2600	0.525	0.075	16,770	1622	0.488	0.075	13,650	1235	0.462	0.075
R 1	20,280	2829	0.600	0.100	13,650	1747	0.558	0.100	11,310	1352	0.528	0.100
R1.25	16,887	2829	0.700	0.125	11,310	1747	0.651	0.125	9,360	1352	0.616	0.125
R1.5	13,494	2829	0.800	0.150	8,970	1747	0.744	0.150	7,410	1352	0.704	0.150
R2	10,296	2912	1.000	0.200	6,864	1830	0.930	0.200	5,616	1404	0.880	0.200
R2.5	9,750	3349	1.200	0.250	6,474	2080	1.116	0.250	4,992	1482	1.056	0.250
R3	8,073	3203	1.500	0.300	5,382	1997	1.395	0.300	4,134	1456	1.320	0.300
R4	6,084	2995	2.000	0.400	4,056	1851	1.860	0.400	3,120	1326	1.760	0.400
R5	4,797	2829	2.500	1.000	3,198	1726	2.325	1.000	2,496	1248	2.200	1.000
R6	4,095	2829	3.000	1.200	2,730	1726	2.790	1.200	2,067	1248	2.640	1.200
R8	3,385	2538	4.000	1.600	2,028	1498	3.720	1.600	1,435	935	3.520	1.600

**절입량**  
Depth of Cut

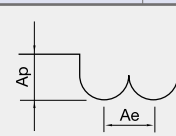

Ap : Axial Depth 축방향의절입깊이(mm)  
 Ae : Radial Depth 반경방향의절입깊이(mm)  
 D : Outside Diameter 외경(mm)  
 n : Speed 회전속도 (min<sup>-1</sup>)  
 Vf : Feed 이송속도 (mm/min)

- HRC52 이상 고경도강 가공시 같은 직경의 같은 비율로 20% DOWN 시켜주십시오.
- 유효장이 없는 절삭조건은 같은 직경에 더 짧은 유효장 대비 같은 비율로 DOWN 해주십시오.
- 유효장 길이가 긴 경우, RPM과 FEED를 동일 비율로 낮춰주세요.
- 에어브로 혹은 미스트 콜러트를 추천하며, 동가공시 습식 콜러트 추천 합니다.
- 상기 절삭조건은 참고 수치이므로 실 가공시 가공 형상, 가공 목적, 적용 기계에 따라 조건변경 요망 합니다.
- 진동이 적고 강성이 좋은 공작기계 사용 요망 합니다 (Ø1이하 사용시 진동 허용 관리 5µm이내 일것.)
- 칩 제거 주의 및 가공시 발열, 발화에 주의 하십시오.
- When milling workpiece HRC over 52 hardened steel , reduce 20% of the RPM and feed compared to the same diameter.
- If the effective length of your tool does not show above the table, use the shorten effective length of parameter and reduce the parameters in the same proportion.
- In case of long effective length, reduce the RPM and feed in same proportion.
- Air blow or oil mist is recommended for smooth chip emission, and dry milling is recommended for copper material.
- Use this table for your reference. Adjust the parameters depending on your machining geometry, machining purpose and CNC.
- Use a machine with low vibration and good rigidity (Ø1 or less, the vibration tolerance management should be within 5µm).
- During the chip evacuation, note for heat and ignition.

## 홈절삭 Slotting

피삭재 Material	공구강 / 금형강 Tool steels / Mold steels SCM / HPM				합금강 / 프리하든강 Alloy Steels / Pre-hardened Steels NAK80 / KP4M				고경도강 Hardened Steels STAVX / SKD11			
	경도 Hardness 30 ~ 40Hrc				40 ~ 45Hrc				45 ~ 55Hrc			
외경 Outside Diameter	RPM	FEED	Ap Axial Depth	Ae Radial Depth	RPM	FEED	Ap Axial Depth	Ae Radial Depth	RPM	FEED	Ap Axial Depth	Ae Radial Depth
Ø 0.2	50,000	230	0.02	0.20	45,000	207	0.01	0.10	40,000	176	0.01	0.10
Ø 0.5	50,000	660	0.05	0.50	45,000	594	0.03	0.25	40,000	505	0.03	0.25
Ø 0.7	50,000	810	0.07	0.70	45,000	729	0.04	0.35	37,500	620	0.04	0.35
Ø 0.9	49,000	1,180	0.09	0.90	39,000	1062	0.05	0.45	27,800	903	0.05	0.45
Ø 1	48,000	1,350	0.10	1.00	38,000	1215	0.05	0.50	25,500	1033	0.05	0.50
Ø 1.5	42,000	1,440	0.15	1.50	30,000	1296	0.08	0.75	21,500	1102	0.08	0.75
Ø 2	33,300	1,530	0.20	2.00	26,000	1377	0.10	1.00	17,500	1170	0.10	1.00
Ø 2.5	26,500	1,530	0.25	2.50	22,500	1377	0.13	1.25	15,800	1170	0.13	1.25
Ø 3	21,800	1,800	0.30	3.00	17,300	1620	0.15	1.50	11,500	1377	0.15	1.50
Ø 4	16,700	2,160	0.40	4.00	13,200	1944	0.20	2.00	8,800	1652	0.20	2.00
Ø 5	15,700	2,610	0.50	5.00	12,500	2349	0.25	2.50	8,300	1997	0.25	2.50
Ø 6	13,100	2,700	0.60	6.00	10,350	2430	0.30	3.00	6,900	2066	0.30	3.00
Ø 8	9,880	2,375	0.80	8.00	7,800	2137	0.40	4.00	5,200	1817	0.40	4.00
Ø 10	7,800	2,050	1.00	10.00	6,150	1845	0.50	5.00	4,100	1568	0.50	5.00
Ø 12	6,650	1,710	1.20	12.00	5,250	1539	0.60	6.00	3,500	1308	0.60	6.00
Ø 16	5,540	1,670	1.60	16.00	4,340	1503	0.80	8.00	2,600	1278	0.80	8.00

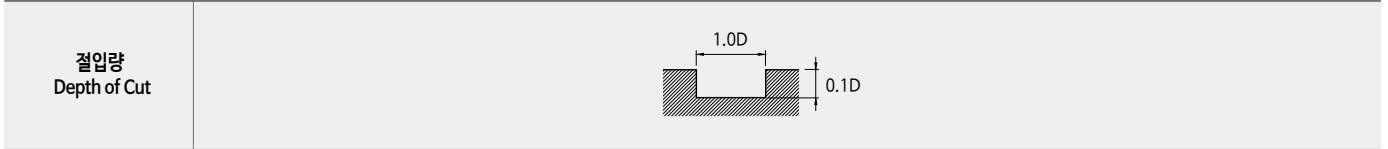

## 측면절삭 Side Cutting

피삭재 Material	공구강 / 금형강 Tool steels / Mold steels SCM / HPM				합금강 / 프리하든강 Alloy Steels / Pre-hardened Steels NAK80 / KP4M				고경도강 Hardened Steels STAVX / SKD11			
	경도 Hardness 30 ~ 40Hrc				40 ~ 45Hrc				45 ~ 55Hrc			
외경 Outside Diameter	RPM	FEED	Ap Axial Depth	Ae Radial Depth	RPM	FEED	Ap Axial Depth	Ae Radial Depth	RPM	FEED	Ap Axial Depth	Ae Radial Depth
Ø 1	48,000	1,260	1.00	0.03	38,000	980	0.50	0.02	25,500	610	0.50	0.02
Ø 2	33,300	1,440	2.00	0.06	26,000	1160	1.00	0.04	17,500	720	1.00	0.04
Ø 3	21,800	1,440	3.00	0.09	17,300	1160	1.50	0.06	11,500	720	1.50	0.06
Ø 4	16,700	1,500	4.00	0.12	13,200	1200	2.00	0.08	8,800	750	2.00	0.08
Ø 5	15,700	1,740	5.00	0.15	12,500	1380	2.50	0.10	8,300	850	2.50	0.10
Ø 6	13,100	1,620	6.00	0.18	10,350	1320	3.00	0.12	6,900	830	3.00	0.12
Ø 8	9,880	1,584	8.00	0.24	7,800	1230	4.00	0.16	5,200	760	4.00	0.16
Ø 10	7,800	1,440	10.00	0.30	6,150	1160	5.00	0.20	4,100	700	5.00	0.20
Ø 12	6,650	1,440	12.00	0.36	5,250	1160	6.00	0.24	3,500	700	6.00	0.24
Ø 16	5,540	1,200	16.00	0.39	4,340	1055	8.00	0.32	2,600	630	8.00	0.32

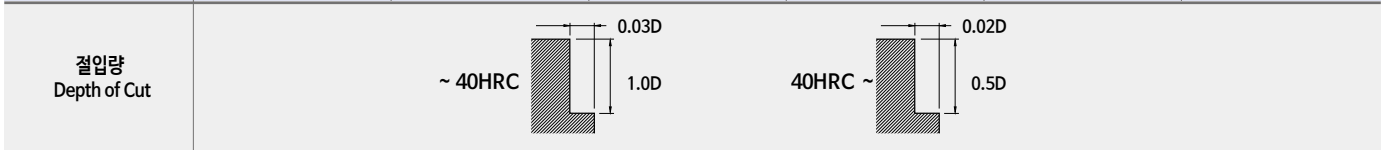

- 날 끝이 정밀하게 연삭되어 있습니다. 파손을 피하기 위해 가능하면 비접촉 방식으로 측정하십시오.
- HRC52 이상 고경도강 가공시 같은 직경 같은 비율로 20% DOWN 시켜주십시오.
- 상기 절삭 조건표는 2날 기준이며, 4날시 회전수는 유지하고, 피드는 안정적인 속도 내에서 최대 30%까지 UP 해주십시오.
- 상기 절삭조건은 참고 수치이므로 실 가공시 가공 형상, 가공 목적, 적용 기계에 따라 조건변경 요망 합니다.
- 조건표가 기계의 최대 스피드 속도를 초과하거나 버 및 적열 현상이 발생할때 스피드 속도와 이송속도를 비례하여 조정 하십시오.
- 진동이 적고 강성이 좋은 공작기계 사용 요망 합니다 (Ø1이하 사용시 진동 허용 관리 5µm 이내 일것.)
- 에어브로, 절삭유, 오일 미스트 콜러트를 추천하며, 칩을 잘 제거하고 가공시 발열과 발화에 주의 하십시오

- The edge of the flute precisely grinded. If you want to measure the tool, and to avoid damaging on the flutes, use non-contact measuring method.
- When milling workpiece HRC over 52 hardened steel , reduce 20% of the RPM and feed compared to the same diameter.
- The parameters on the table is based on 2flutes. For using 4flutes, use the same RPM and raise up the feed up to 30% in stable milling condition.
- Use this table for your reference. Adjust the parameters depending on your machining geometry, machining purpose and CNC.
- If the table over the maximum RPM and feed of your machine, or found red heat on the material, adjust RPM and feed in the same proportion.
- Use a machine with low vibration and good rigidity (Ø1 or less, the vibration tolerance management should be within 5µm).
- Air blow or mist coolants are recommended and note for chip emission, heat, or ignition.

홈절삭 Slotting												
피삭재 Material	공구강 / 금형강 Tool steels / Mold steels SCM / HPM				합금강 / 프리하든강 Alloy Steels / Pre-hardened Steels NAK80 / KP4M				고경도강 Hardened Steels STAVX / SKD11			
경도 Hardness	30 ~ 40HRC				40 ~ 45HRC				45 ~ 55HRC			
외경 Outside Diameter	RPM	FEED	Ap Axial Depth	Ae Radial Depth	RPM	FEED	Ap Axial Depth	Ae Radial Depth	RPM	FEED	Ap Axial Depth	Ae Radial Depth
∅ 1	13,000	75	1	0.03	9,000	65	0.50	0.02	5,700	41	0.05	0.50
∅ 1.5	10,000	75	2	0.045	6,000	65	0.75	0.03	4,500	41	0.08	0.75
∅ 2	6,400	188	2	0.06	4,800	162	1.00	0.04	3,000	102	0.10	1.00
∅ 3	4,200	375	3	0.09	3,400	324	1.50	0.06	2,100	204	0.15	1.50
∅ 4	3,400	413	4	0.12	2,700	356	2.00	0.08	1,700	204	0.20	2.00
∅ 5	2,900	563	5	0.15	2,300	486	2.50	0.10	1,500	306	0.25	2.50
∅ 6	2,500	788	6	0.18	2,000	680	3.00	0.12	1,300	428	0.30	3.00
∅ 8	1,900	813	8	0.24	1,500	702	4.00	0.16	1,000	442	0.40	4.00
∅ 10	1,600	750	10	0.3	1,300	648	5.00	0.20	800	408	0.50	5.00
∅ 12	1,300	731	12	0.36	1,100	632	6.00	0.24	670	398	0.60	6.00

~ 40HRC

40HRC ~

측면절삭 Side Cutting												
피삭재 Material	공구강 / 금형강 Tool steels / Mold steels SCM / HPM				합금강 / 프리하든강 Alloy Steels / Pre-hardened Steels NAK80 / KP4M				고경도강 Hardened Steels STAVX / SKD11			
경도 Hardness	30 ~ 40HRC				40 ~ 50HRC				50 ~ 52HRC			
외경 Outside Diameter	RPM	FEED	Ap Axial Depth	Ae Radial Depth	RPM	FEED	Ap Axial Depth	Ae Radial Depth	RPM	FEED	Ap Axial Depth	Ae Radial Depth
∅ 1	13,000	75	1	0.030	9,000	65	0.5	0.02	5,700	49	0.50	0.02
∅ 1.5	10,000	75	2	0.045	6,000	65	0.75	0.03	4,500	49	0.75	0.03
∅ 2	6,400	188	2	0.060	4,800	162	1.00	0.04	3,000	122	1.00	0.04
∅ 3	4,200	375	3	0.090	3,400	324	1.50	0.06	2,100	245	1.50	0.06
∅ 4	3,400	413	4	0.120	2,700	356	2.00	0.08	1,700	269	2.00	0.08
∅ 5	2,900	563	5	0.150	2,300	486	2.50	0.10	1,500	367	2.50	0.10
∅ 6	2,500	788	6	0.180	2,000	680	3.00	0.12	1,300	514	3.00	0.12
∅ 8	1,900	813	8	0.240	1,500	702	4.00	0.16	1,000	530	4.00	0.16
∅ 10	1,600	750	10	0.300	1,300	648	5.00	0.20	800	490	5.00	0.20
∅ 12	1,300	731	12	0.360	1,100	632	6.00	0.24	670	477	6.00	0.24

~ 40HRC

40HRC ~

- 날 끝이 정밀하게 연삭되어 있습니다. 파손을 피하기 위해 가능하면 비접촉 방식으로 측정 하십시오.
- HRC55 이상 고경도강 가공시 같은 직경 같은 비율로 20% DOWN 시켜주십시오.
- 상기 절삭 조건표는 3날 기준이며, 4날시 회전수는 유지하고, 피드는 안정적인 속도 내에서 최대 50%까지 UP 해주십시오.
- 상기 절삭조건은 참고 수치이므로 실 가공시 가공 형상, 가공 목적, 적용 기계에 따라 조건변경 요망 합니다.
- 조건표가 기계의 최대 스피들 속도를 초과 하거나 버 및 적열 현상이 발생할때 스피들 속도와 이송속도를 비례하여 조정 하십시오.
- 에어브로, 절삭유, 오일 미스트 쿨러트를 추천하며, 칩을 잘 제거하고 가공시 발열과 발화에 주의 하십시오
- The edge of the flute precisely grinded. If you want to measure the tool, and to avoid damaging on the flutes, use non-contact measuring method.
- When milling workpiece HRC over 55 hardened steel , reduce 20% of the RPM and feed compared to the same diameter.
- The parameters on the table is based on 3flutes. For using 4flutes, use the same RPM and raise up the feed up to 50% in stable milling condition.
- Use this table for your reference. Adjust the parameters depending on your machining geometry, machining purpose and CNC.
- If the table over the maximum RPM and feed of your machine, or found red heat on the material, adjust RPM and feed in the same proportion.
- Air blow or mist coolants are recommended and note for chip emission, heat, or ignition.

측면절삭 Side Cutting												
피삭재 Material	공구강/금형강 Tool steels / Mold steels SCM/HPM				합금강/프리하든강 Alloy Steels / Pre-hardened Steels NAK80 / KP4M				고경도강 Hardened Steels STAVX / SKD11			
경도 Hardness	30 ~ 40HRC				40 ~ 45HRC				45 ~ 55HRC			
외경 Outside Diameter	RPM	FEED	Ap Axial Depth	Ae Radial Depth	RPM	FEED	Ap Axial Depth	Ae Radial Depth	RPM	FEED	Ap Axial Depth	Ae Radial Depth
∅ 1	40,000	432	1.5	0.050	40,000	396	0.5	0.03	40,000	277	0.50	0.03
∅ 1.5	40,000	540	2.3	0.075	40,000	450	0.75	0.05	38,500	315	0.75	0.05
∅ 2	40,000	720	3.0	0.100	38,000	648	1.00	0.06	36,500	450	1.00	0.06
∅ 3	38,400	1,643	4.5	0.150	34,560	1,476	1.50	0.09	27,650	1,035	1.50	0.09
∅ 4	28,800	1,899	6.0	0.200	25,920	1,710	2.00	0.12	20,730	1,197	2.00	0.12
∅ 5	24,000	2,160	7.5	0.250	21,600	1,944	2.50	0.15	17,280	1,359	2.50	0.15
∅ 6	19,200	2,507	9.0	0.300	17,280	2,255	2.50	0.18	13,820	1,575	2.50	0.18
∅ 8	14,400	2,507	12.0	0.400	12,960	2,255	3.00	0.24	10,370	1,575	3.00	0.24
∅ 10	11,520	2,507	15.0	0.500	10,360	2,255	4.00	0.30	8,290	1,575	4.00	0.30
∅ 12	9,600	2,070	18.0	0.600	8,640	1,863	6.00	0.36	6,900	1,305	6.00	0.36
∅ 14	8,950	1,859	21.0	0.700	8,140	1,683	7.00	0.42	6,120	1,107	7.00	0.42
∅ 16	7,200	1,557	24.0	0.800	6,480	1,400	8.00	0.48	5,190	981	8.00	0.48

절입량  
Depth of Cut

- 날 끝이 정밀하게 연삭되어 있습니다. 파손을 피하기 위해 가능하면 비접촉 방식으로 측정하십시오.
- HRC52 이상 고경도강 가공시 같은 직경의 같은 비율로 20% DOWN 시켜주십시오.
- 유효장이 길게 체결할시 회전수와 피드를 같은 비율로 DOWN 해주십시오.
- 상기 절삭조건은 참고 수치이며 실 가공시 가공 형상, 가공 목적, 적용 기계에 따라 조건변경 요망 합니다.
- 조건표가 기계의 최대 스피들 속도를 초과 하거나 버 및 적열 현상이 발생할때 스피들 속도와 이송속도를 비례하여 조정 하십시오.
- 에어브로, 절삭유, 오일 미스트 콜러트를 추천하며, 칩을 잘 제거하고 가공시 발열과 발화에 주의 하십시오
- The edge of the flute precisely grinded. If you want to measure the tool, and to avoid damaging on the flutes, use non-contact measuring method.
- When milling workpiece HRC over 52 hardened steel , reduce 20% of the RPM and feed compared to the same diameter.
- If you clamp the endmill with long overhang of effective length, reduce the RPM and feed in the same proportion.
- Use this table for your reference. Adjust the parameters depending on your machining geometry, machining purpose and CNC.
- If the table over the maximum RPM and feed of your machine, or found red heat on the material, adjust RPM and feed in the same proportion.
- Air blow or mist coolants are recommended and note for chip emission, heat, or ignition.

홈절삭 Slotting												
피삭재 Material	공구강 / 금형강 Tool steels / Mold steels SCM / HPM				합금강 / 프리하든강 Alloy Steels / Pre-hardened Steels NAK80 / KP4M				고경도강 Hardened Steels STAVX / SKD11			
경도 Hardness	30 ~ 40Hrc				40 ~ 45Hrc				45 ~ 55Hrc			
외경 Outside Diameter	RPM	FEED	Ap Axial Depth	Ae Radial Depth	RPM	FEED	Ap Axial Depth	Ae Radial Depth	RPM	FEED	Ap Axial Depth	Ae Radial Depth
∅ 1	43,200	1,224	0.05	1.0	24,200	990	0.02	0.8	22,950	660	0.02	0.80
∅ 1.5	28,250	1,296	0.08	1.5	23,850	1,090	0.03	1.2	20,340	726	0.03	1.20
∅ 2	29,970	1,458	0.10	2.0	15,570	1,200	0.04	1.6	15,750	776	0.04	1.60
∅ 3	19,620	1,482	0.15	3.0	11,880	1,230	0.06	2.4	10,350	792	0.06	2.40
∅ 4	15,030	1,518	0.20	4.0	11,250	1,310	0.08	3.2	7,920	809	0.08	3.20
∅ 5	14,130	1,620	0.25	5.0	9,315	1,280	0.10	4.0	7,470	858	0.10	4.00
∅ 6	11,790	1,578	0.30	6.0	7,020	1,170	0.12	4.8	6,210	842	0.12	4.80
∅ 8	8,890	1,440	0.40	8.0	5,530	1,090	0.16	6.4	4,680	776	0.16	6.40
∅ 10	7,020	1,344	0.50	10.0	4,720	1,090	0.20	8.0	3,690	726	0.20	8.00
∅ 12	5,985	1,344	0.60	12.0	4,350	1,050	0.24	9.6	3,150	726	0.24	9.60

~ 40HRC

40HRC ~

경사진면절삭  
Inclined Cutting

측면절삭 Side Cutting												
피삭재 Material	공구강 / 금형강 Tool steels / Mold steels SCM / HPM				합금강 / 프리하든강 Alloy Steels / Pre-hardened Steels NAK80 / KP4M				고경도강 Hardened Steels STAVX / SKD11			
경도 Hardness	30 ~ 40Hrc				40 ~ 45Hrc				45 ~ 55Hrc			
외경 Outside Diameter	RPM	FEED	Ap Axial Depth	Ae Radial Depth	RPM	FEED	Ap Axial Depth	Ae Radial Depth	RPM	FEED	Ap Axial Depth	Ae Radial Depth
∅ 1	43,200	870	1.5	0.050	34,200	702	0.5	0.03	22,950	470	0.50	0.03
∅ 1.5	37,080	980	2.3	0.075	29,250	801	0.75	0.05	19,350	550	0.75	0.05
∅ 2	29,970	1,280	3.0	0.100	23,400	1,035	1.00	0.06	15,750	690	1.00	0.06
∅ 3	19,620	1,300	4.5	0.150	15,570	1,062	1.50	0.09	13,500	700	1.50	0.09
∅ 4	15,030	1,330	6.0	0.200	11,880	1,080	2.00	0.12	7,920	720	2.00	0.12
∅ 5	14,130	1,550	7.5	0.250	11,250	1,260	2.50	0.15	7,470	840	2.50	0.15
∅ 6	11,790	1,440	9.0	0.300	9,310	1,170	2.50	0.18	6,210	780	2.50	0.18
∅ 8	8,890	1,410	12.0	0.400	7,020	1,143	3.00	0.24	4,680	760	3.00	0.24
∅ 10	7,020	1,280	15.0	0.500	5,530	1,035	4.00	0.30	3,690	690	4.00	0.30
∅ 12	5,980	1,280	18.0	0.600	4,720	1,035	6.00	0.36	3,150	690	6.00	0.36

~ 40HRC

40HRC ~

- 상기 절삭조건표는 2날 기준이며, 4날시 회전수는 유지하고 피드는 안정적인 속도 내에서 최대30%까지 UP 해주십시오.
- HRC52 이상인 경우 같은 직경의 같은 비율로 20% DOWN 시켜주십시오.
- 유효장이 긴 경우에는 회전수와 이송속도를 최대30% 이하로 줄이십시오.
- 곡면 절삭시 날경의 코너R 보다 낮은 이동PITCH를 설정 하십시오.
- 곡면 절삭시 안정적인 속도 내에서 피드를 최대 30%까지 UP 해주십시오.
- 홈 절삭시 날경의 코너R 대비 Ae 값을 설정 하십시오.
- 상기 절삭조건은 참고 수치이며 실 가공시 가공 형상, 가공 목적, 적용 기계에 따라 조건변경 요망 합니다.
- 피삭재와 절삭형상을 위한 적절한 쿨런트 사용과 가공시 발열, 발화에 주의 하십시오.
- The parameters on the table is based on 2 flutes. For using 4 flutes, use the same RPM and raise up the feed up to 30% in stable milling condition.
- When milling workpiece HRC over 52 hardened steel, reduce 20% of the RPM and feed compared to the same diameter.
- If the effective length is long, reduce the RPM and feed maximum 30%.
- For curved milling, set up the lower value of the pitch than the corner radius value of tool diameter.
- For curved milling, raise up the feed up to 30% in stable milling condition.
- For groove milling, set up the Ae value by considering of corner radius value.
- Use this table for your reference. Adjust the parameters depending on your machining geometry, machining purpose and CNC.
- Use the adequate coolant for work material and machining geometry and note for heat and ignition.

피삭재 Material		공구강/금형강 Tool steels / Mold steels SCM/HPM				합금강/프리하드강 Alloy Steels / Pre-hardened Steels NAK80 / KP4M				고경도강 Hardened Steels STAVAX / SKD11			
경도 Hardness		30 ~ 40Hrc				40 ~ 45Hrc				45 ~ 55Hrc			
외경 Outside Diameter	반경 Corner Radius	RPM	FEED	Ap Axial Depth	Ae Radial Depth	RPM	FEED	Ap Axial Depth	Ae Radial Depth	RPM	FEED	Ap Axial Depth	Ae Radial Depth
∅ 1	R0.2	40,500	4,361	0.02	0.40	37,800	4,858	0.02	0.30	31,500	3,207	0.02	0.30
∅ 1.5	R0.5	36,000	5,607	0.03	0.60	36,000	4,984	0.02	0.45	27,000	3,302	0.02	0.45
∅ 2	R0.5	29,700	6,230	0.04	0.80	24,300	5,236	0.03	0.60	21,600	3,535	0.03	0.60
∅ 3	R0.5	19,800	6,853	0.06	1.20	16,200	5,607	0.05	0.90	14,400	4,007	0.05	0.90
∅ 4	R0.5	17,100	8,099	0.08	1.60	14,400	6,230	0.06	1.20	11,700	4,717	0.06	1.20
"	R1.0	15,300	7,476	0.08	1.60	12,600	5,915	0.06	1.20	10,800	4,150	0.06	1.20
∅ 5	R0.5	13,500	8,722	0.10	2.00	10,800	7,476	0.08	1.50	9,900	4,717	0.08	1.50
"	R1.0	11,700	8,099	0.10	2.00	9,900	6,853	0.08	1.50	8,640	4,479	0.08	1.50
∅ 6	R0.5	11,680	9,555	0.12	2.40	9,540	8,099	0.09	1.80	8,550	5,660	0.09	1.80
"	R1.0	11,340	7,847	0.12	2.40	8,930	7,476	0.09	1.80	8,100	5,189	0.09	1.80
"	R1.5	9,900	8,099	0.12	2.40	8,100	6,853	0.09	1.80	7,200	4,526	0.09	1.80
∅ 8	R0.5	7,920	10,249	0.16	3.20	7,380	7,882	0.12	2.40	6,390	6,132	0.12	2.40
"	R1.0	7,560	9,345	0.16	3.20	7,200	7,672	0.12	2.40	6,030	5,189	0.12	2.40
"	R2.0	7,380	8,099	0.16	3.20	6,300	6,853	0.12	2.40	5,400	4,526	0.12	2.40
∅ 10	R0.5	6,730	9,310	0.20	4.00	5,700	7,882	0.15	3.00	4,970	5,152	0.15	3.00
"	R1.0	6,550	9,072	0.20	4.00	5,540	7,672	0.15	3.00	4,840	5,019	0.15	3.00
"	R2.0	5,850	8,099	0.20	4.00	4,950	6,853	0.15	3.00	4,320	4,479	0.15	3.00
∅ 12	R0.5	6,300	9,345	0.24	4.80	4,880	7,351	0.18	3.60	4,350	5,009	0.18	3.60
"	R1.0	5,760	8,722	0.24	4.80	4,760	7,161	0.18	3.60	4,240	4,881	0.18	3.60
"	R2.0	5,400	7,784	0.24	4.80	4,640	6,979	0.18	3.60	4,130	4,754	0.18	3.60
"	R3.0	4,950	7,476	0.24	4.80	4,140	6,230	0.18	3.60	3,690	4,245	0.18	3.60

절입량  
Depth of Cut

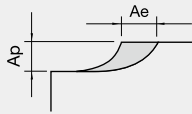

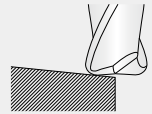

경사진면절삭  
Inclined Cutting

### ■ Coefficients respective of tool overhang

Type	Overhang	Revolution	Feed rate	Depth of Cut ap
Straight	L/D ≤ 5	100%	100%	100%
	L/D = 6	90%	80%	80%
	L/D = 7	80%	70%	70%
Taper neck	L/D = 6	100%	100%	100%
	L/D = 8	90%	80%	80%
	L/D ≥ 10	80%	70%	70%

- 유효장이 긴 경우에는 회전수와 이송속도를 최대30% 이하로 줄이십시오.
- 측면 절삭시 코너R 참고하여 절삭 하시기 바랍니다.
- 곡면 절삭시 날경의 코너R 보다 낮은 이동 PITCH를 설정 하십시오.
- 곡면 절삭시 안정적인 속도 내에서 피드를 최대 30%까지 UP 해주십시오.
- 상기 절삭조건은 참고 수치이므로 실 가공시 가공 형상, 가공 목적, 적용 기계에 따라 조건변경 요망 합니다.
- 적용 기계의 회전 속도가 부족한 경우에는 회전 속도와 이송 속도를 같은 비율로 줄여서 적용합니다.
- 유효장 길이가 긴 경우, 위 표와같이 RPM과 FEED를 낮춰주세요.
- 절입깊이가 얇은 경우, RPM과 FEED를 증가해주세요.
- 원활한 칩배출을 위하여 에어브로우나 오일 미스트를 추천합니다.
- If the effective length is long, reduce the RPM and feed maximum 30%.
- For side milling, refer to the corner radius value.
- For curved milling, set up the lower value of the pitch than the corner radius value of tool diameter.
- For curved milling, raise up the feed up to 30% in stable milling condition.
- Use this table for your reference. Adjust the parameters depending on your machining geometry, machining purpose and CNC.
- If the table over the maximum RPM and feed of your machine, adjust RPM and feed in the same proportion.
- If the effective length is long, refer to the table (Coefficients respective of tool overhang) and adjust the RPM and feed.
- If you use small value of Ap, raise up the RPM and feed.
- Air blow or oil mist is recommended for smooth chip emission.



피삭재 Material		동 Copper alloys C1100				합금강 / 프리하드강 Alloy Steels / Prehardened Steels NAK80/KP4M				고경도강 Hardened Steels STAVAX/SKD11			
경도 Hardness						40 ~ 45HRc				45 ~ 55HRc			
반경 Radius	유효장 Effective Length	RPM	FEED	Ap Axial Depth	Ae Radial Depth	RPM	FEED	Ap Axial Depth	Ae Radial Depth	RPM	FEED	Ap Axial Depth	Ae Radial Depth
R0.05	—	54,000	85	0.004	0.004	48,000	75	0.004	0.004	48,000	55	0.002	0.002
	0.5	54,000	430	0.010	0.010	48,000	350	0.006	0.007	48,000	280	0.006	0.007
R0.1	1	54,000	380	0.008	0.008	48,000	330	0.005	0.005	48,000	250	0.005	0.005
	1.5	47,000	320	0.006	0.006	47,000	250	0.004	0.004	47,000	200	0.004	0.004
R0.15	2	42,000	290	0.004	0.004	42,000	200	0.003	0.003	42,000	200	0.003	0.003
	1.5	54,000	640	0.014	0.015	48,000	480	0.010	0.010	41,000	370	0.009	0.010
	2	49,000	530	0.011	0.011	43,000	370	0.008	0.008	37,000	270	0.008	0.008
	3	43,000	460	0.009	0.010	38,000	320	0.007	0.006	32,000	240	0.006	0.006
	4	37,000	300	0.004	0.006	28,000	200	0.003	0.004	24,000	160	0.003	0.004
R0.2	5	31,000	200	0.002	0.004	26,000	125	0.001	0.003	18,000	110	0.002	0.003
	1	54,000	870	0.023	0.036	48,000	660	0.018	0.024	37,000	450	0.015	0.024
	2	54,000	790	0.022	0.036	48,000	590	0.018	0.024	37,000	400	0.015	0.020
	3	50,000	660	0.017	0.018	41,000	420	0.012	0.012	31,000	280	0.011	0.012
	4	50,000	640	0.012	0.018	38,000	400	0.009	0.012	30,000	270	0.009	0.012
	5	37,000	410	0.009	0.018	29,000	330	0.008	0.012	26,000	260	0.007	0.012
	6	37,000	360	0.006	0.010	29,000	260	0.005	0.006	26,000	200	0.004	0.006
	8	27,000	200	0.003	0.006	27,000	170	0.003	0.003	23,000	150	0.002	0.003
R0.25	10	20,000	110	0.002	0.004	25,000	110	0.002	0.002	20,000	110	0.001	0.002
	1	57,000	1,380	0.029	0.054	42,000	830	0.023	0.036	32,000	550	0.018	0.036
	2	57,000	1,250	0.028	0.054	42,000	750	0.022	0.036	32,000	500	0.018	0.036
	3	55,000	1,010	0.021	0.036	38,000	580	0.017	0.024	31,000	400	0.014	0.024
	4	55,000	1,010	0.021	0.036	38,000	580	0.017	0.024	31,000	400	0.014	0.024
	5	48,000	800	0.016	0.018	33,000	480	0.012	0.012	30,000	390	0.009	0.012
	6	36,000	610	0.009	0.018	28,000	400	0.008	0.012	27,000	330	0.005	0.012
	8	36,000	590	0.009	0.018	28,000	400	0.008	0.012	27,000	330	0.005	0.012
	10	36,000	460	0.009	0.018	28,000	400	0.008	0.012	27,000	330	0.005	0.012
	12	24,000	280	0.004	0.010	26,000	280	0.004	0.006	24,000	280	0.002	0.006
R0.3	14	16,000	170	0.001	0.006	24,000	200	0.002	0.003	21,000	240	0.001	0.003
	1	57,000	1,670	0.035	0.144	37,000	840	0.027	0.096	27,000	540	0.023	0.096
	2	57,000	1,540	0.034	0.144	37,000	770	0.027	0.096	27,000	500	0.021	0.096
	3	57,000	1,540	0.034	0.144	37,000	770	0.027	0.096	27,000	500	0.021	0.096
	4	54,000	1,130	0.026	0.108	35,000	600	0.020	0.072	26,000	380	0.016	0.072
	5	46,000	960	0.019	0.072	28,000	460	0.016	0.048	26,000	370	0.012	0.048
	6	46,000	960	0.019	0.072	28,000	460	0.016	0.048	26,000	370	0.012	0.048
	8	30,000	570	0.010	0.054	24,000	400	0.009	0.036	23,000	320	0.006	0.036
	10	30,000	490	0.007	0.036	24,000	330	0.006	0.024	23,000	290	0.004	0.024
R0.35	12	30,000	490	0.007	0.036	24,000	330	0.006	0.024	23,000	290	0.004	0.024
	14	20,000	300	0.004	0.027	22,000	300	0.004	0.018	20,000	250	0.002	0.018
	16	13,000	180	0.002	0.020	21,000	260	0.002	0.014	18,000	220	0.001	0.014
	2	56,000	1,800	0.050	0.162	35,000	740	0.039	0.108	27,000	500	0.031	0.108
	4	54,500	1,500	0.045	0.063	33,000	600	0.035	0.062	26,500	410	0.029	0.096
	8	32,000	800	0.019	0.072	25,000	420	0.020	0.048	22,500	355	0.012	0.048
	10	26,500	540	0.017	0.063	22,500	380	0.014	0.042	21,500	330	0.011	0.042
R0.4	12	23,000	420	0.017	0.063	21,500	380	0.012	0.032	21,500	320	0.010	0.042
	2	55,000	2,060	0.063	0.180	33,000	710	0.050	0.120	27,000	500	0.041	0.120
	4	55,000	1,860	0.063	0.180	31,000	600	0.050	0.120	27,000	440	0.041	0.120
	6	47,000	1,410	0.038	0.108	28,000	570	0.030	0.072	22,000	390	0.024	0.072
	8	34,000	1,040	0.027	0.090	21,000	430	0.021	0.060	22,000	390	0.018	0.060
	10	23,000	600	0.027	0.090	21,000	430	0.021	0.060	20,000	370	0.017	0.060
	12	16,000	350	0.027	0.090	19,000	430	0.018	0.040	20,000	350	0.016	0.060
	14	11,000	200	0.027	0.090	19,000	430	0.015	0.027	20,000	330	0.015	0.060
R0.45	16	7,600	115	0.027	0.090	16,000	430	0.013	0.018	20,000	310	0.014	0.060
	4	50,500	1,900	0.067	0.190	32,000	685	0.054	0.130	24,500	460	0.043	0.180
	2	46,000	2,000	0.072	0.360	32,000	770	0.057	0.240	22,000	480	0.045	0.240
	3	46,000	2,000	0.072	0.360	32,000	770	0.057	0.240	22,000	480	0.045	0.240
	4	46,000	2,000	0.071	0.360	32,000	770	0.057	0.240	22,000	480	0.045	0.240
	5	46,000	2,000	0.071	0.360	32,000	770	0.057	0.240	22,000	480	0.045	0.240
	6	39,000	1,500	0.071	0.180	26,000	760	0.055	0.120	17,600	480	0.035	0.120
	8	39,000	1,500	0.043	0.180	26,000	760	0.034	0.120	17,600	480	0.027	0.120
	10	29,000	1,110	0.028	0.090	17,600	530	0.024	0.060	16,500	420	0.018	0.060
	12	18,700	660	0.027	0.090	17,600	530	0.024	0.060	16,500	420	0.018	0.060
R0.5	14	18,700	640	0.022	0.090	15,400	440	0.018	0.060	14,300	360	0.014	0.060
	16	18,700	640	0.022	0.090	15,400	440	0.018	0.060	14,300	360	0.014	0.060
	18	18,700	540	0.017	0.090	14,300	440	0.013	0.060	13,200	360	0.009	0.060
	20	18,700	540	0.017	0.054	14,300	360	0.013	0.036	13,200	300	0.009	0.036
	22	18,700	540	0.017	0.054	14,300	360	0.013	0.036	13,200	300	0.009	0.036
	25	18,700	540	0.016	0.052	14,300	360	0.013	0.030	13,200	300	0.009	0.030

피삭재 Material		동 합금 Copper alloys C1100				합금강 / 프리하드강 Alloy Steels / Prehardened Steels NAK80/KP4M				고경도강 Hardened Steels STAVAX/SKD11			
경도 Hardness						40 ~ 45Hrc				45 ~ 55Hrc			
반경 Radius	유효장 Effective Length	RPM	FEED	Ap Axial Depth	Ae Radial Depth	RPM	FEED	Ap Axial Depth	Ae Radial Depth	RPM	FEED	Ap Axial Depth	Ae Radial Depth
R0.6	4	38,000	2,000	0.085	0.360	26,000	770	0.068	0.240	18,200	480	0.054	0.240
	6	38,000	2,000	0.085	0.360	26,000	770	0.068	0.240	18,200	480	0.054	0.240
	8	32,000	1,490	0.084	0.360	21,000	700	0.067	0.240	15,100	440	0.054	0.240
	10	24,000	1,080	0.036	0.180	16,400	530	0.027	0.120	15,100	420	0.022	0.120
	12	24,000	1,080	0.036	0.180	15,300	530	0.027	0.120	14,100	420	0.022	0.120
	16	15,400	580	0.024	0.144	13,100	460	0.019	0.096	11,900	380	0.016	0.096
	20	15,400	580	0.017	0.090	12,100	380	0.013	0.060	11,000	320	0.009	0.060
24	15,400	580	0.010	0.060	11,100	320	0.009	0.040	9,800	290	0.007	0.040	
R0.7	6	28,000	1,470	0.099	0.270	17,600	680	0.076	0.180	13,600	440	0.063	0.180
	8	28,000	1,470	0.099	0.270	17,600	680	0.079	0.180	13,600	440	0.063	0.180
	12	19,800	1,080	0.042	0.270	13,800	530	0.033	0.180	13,600	420	0.027	0.180
	16	13,200	620	0.033	0.180	13,100	480	0.027	0.120	11,900	390	0.021	0.120
R0.75	3	30,000	2,200	0.171	0.324	21,000	1060	0.137	0.216	14,800	660	0.110	0.216
	4	30,000	2,200	0.171	0.324	21,000	1060	0.137	0.216	14,800	660	0.110	0.216
	6	30,000	1,980	0.147	0.324	21,000	940	0.117	0.216	14,800	580	0.090	0.216
	8	26,000	1,500	0.106	0.270	16,300	700	0.084	0.180	12,100	450	0.069	0.180
	10	26,000	1,500	0.106	0.270	16,300	700	0.084	0.180	12,100	450	0.069	0.180
	12	26,000	1,500	0.106	0.270	16,300	700	0.084	0.180	12,100	450	0.069	0.180
	14	18,700	1,100	0.045	0.180	12,600	530	0.036	0.120	12,100	440	0.027	0.120
	16	12,100	620	0.036	0.180	12,400	480	0.027	0.120	11,600	390	0.022	0.120
	18	12,100	620	0.036	0.180	12,400	480	0.027	0.120	11,600	390	0.022	0.120
	20	12,100	620	0.019	0.090	12,400	480	0.016	0.060	11,600	390	0.012	0.060
	22	12,100	620	0.019	0.090	12,400	480	0.016	0.060	11,000	390	0.012	0.060
	25	11,000	500	0.019	0.090	12,400	440	0.016	0.060	11,000	390	0.012	0.060
	30	10,700	450	0.019	0.090	10,900	400	0.016	0.060	11,000	390	0.012	0.060
35	10,700	410	0.019	0.090	9,000	380	0.016	0.060	11,000	390	0.012	0.060	
R0.8	6	27,040	2,600	0.220	0.580	18,900	1200	0.180	0.390	16,500	760	0.150	0.390
	8	26,000	1,970	0.157	0.324	18,900	940	0.126	0.216	13,800	580	0.102	0.216
	12	25,000	1,490	0.112	0.180	15,100	700	0.090	0.120	11,500	440	0.072	0.120
	16	17,600	1,100	0.046	0.144	12,300	530	0.036	0.096	11,400	440	0.030	0.096
	20	11,000	630	0.036	0.090	11,500	480	0.030	0.060	10,900	400	0.024	0.060
R0.9	6	32,000	2,600	0.230	0.210	18,400	1200	0.185	0.320	18,400	738	0.150	0.320
	8	26,000	1,950	0.165	0.270	16,300	930	0.132	0.240	13,800	570	0.108	0.240
	12	21,000	1,480	0.120	0.270	13,800	700	0.094	0.180	10,300	440	0.077	0.180
	16	15,400	1,080	0.048	0.180	10,800	530	0.039	0.120	9,900	420	0.031	0.120
	20	10,500	630	0.039	0.090	10,200	480	0.031	0.060	9,700	400	0.025	0.060
R1	4	22,000	2,140	0.232	0.540	18,500	1260	0.185	0.360	13,200	960	0.150	0.360
	6	22,000	2,140	0.232	0.540	18,500	1260	0.185	0.360	13,200	960	0.150	0.360
	8	22,000	1,920	0.185	0.360	18,500	1120	0.147	0.240	13,200	870	0.120	0.240
	10	22,000	1,920	0.185	0.360	18,500	1120	0.147	0.240	13,200	870	0.120	0.240
	12	18,700	1,470	0.166	0.360	16,000	990	0.133	0.240	11,700	780	0.107	0.240
	14	18,700	1,470	0.166	0.360	16,000	990	0.133	0.240	11,700	780	0.107	0.240
	16	18,700	1,470	0.148	0.360	16,000	990	0.118	0.240	11,700	780	0.090	0.240
	18	14,300	1,070	0.093	0.180	14,700	580	0.074	0.120	11,600	580	0.061	0.120
	20	14,300	1,070	0.093	0.180	14,700	580	0.074	0.120	11,600	580	0.061	0.120
	22	9,500	630	0.074	0.180	10,600	450	0.058	0.120	10,200	450	0.045	0.120
	25	9,500	630	0.074	0.180	10,600	450	0.058	0.120	10,200	450	0.045	0.120
	30	9,500	530	0.033	0.090	10,600	450	0.026	0.060	10,200	380	0.021	0.060
	35	9,500	530	0.026	0.090	10,600	380	0.019	0.060	10,200	380	0.017	0.060
40	9,500	530	0.026	0.090	10,600	380	0.019	0.060	10,200	380	0.017	0.060	
45	9,500	445	0.011	0.045	10,000	380	0.009	0.030	10,200	320	0.008	0.030	
R1.25	8	18,400	2,400	0.232	0.360	14,500	1400	0.185	0.240	9,700	1080	0.150	0.240
	10	18,400	2,400	0.232	0.360	14,500	1400	0.185	0.240	9,700	1080	0.150	0.240
	16	16,100	1,810	0.208	0.360	13,500	1230	0.166	0.240	8,400	980	0.135	0.240
	20	11,500	1,330	0.116	0.180	10,200	950	0.093	0.120	8,400	980	0.074	0.120
	25	6,900	770	0.093	0.180	8,400	540	0.074	0.120	8,400	560	0.061	0.120
	30	6,900	770	0.040	0.090	8,400	540	0.033	0.060	8,400	560	0.026	0.060
35	6,900	770	0.018	0.050	8,400	540	0.015	0.030	8,400	560	0.011	0.030	
R1.5	6	15,000	2,890	0.278	0.540	12,900	1680	0.222	0.360	9,200	1300	0.180	0.360
	8	15,000	2,890	0.278	0.540	12,900	1680	0.222	0.360	9,200	1300	0.180	0.360
	10	15,000	2,600	0.278	0.540	12,900	1680	0.222	0.360	9,200	1300	0.180	0.360
	12	15,000	2,600	0.278	0.540	12,900	1510	0.222	0.360	9,200	1170	0.180	0.360
	16	12,700	1,970	0.290	0.504	11,300	1330	0.166	0.360	8,100	1040	0.135	0.360
	20	12,700	1,970	0.290	0.504	11,300	1330	0.166	0.360	8,100	1040	0.135	0.360
	25	10,100	1,450	0.139	0.270	8,800	1040	0.111	0.180	8,100	1040	0.090	0.180
	30	10,100	1,450	0.139	0.270	8,800	780	0.111	0.180	8,100	780	0.090	0.180
35	6,600	840	0.073	0.270	7,900	620	0.055	0.180	7,500	650	0.045	0.180	

피삭재 Material		동 합금 Copper alloys C1100				합금강 / 프리하든강 Alloy Steels / Prehardened Steels NAK80/KP4M				고경도강 Hardened Steels STAVAX/SKD11			
경도 Hardness						40 ~ 45HRC				45 ~ 55HRC			
반경 Radius	유효장 Effective Length	RPM	FEED	Ap Axial Depth	Ae Radial Depth	RPM	FEED	Ap Axial Depth	Ae Radial Depth	RPM	FEED	Ap Axial Depth	Ae Radial Depth
R1.5	40	6,600	840	0.073	0.270	7,900	620	0.055	0.180	7,500	520	0.045	0.180
	45	4,500	500	0.040	0.270	6,200	500	0.035	0.100	7,000	450	0.023	0.180
	50	4,300	490	0.040	0.270	6,200	500	0.030	0.090	7,000	350	0.023	0.180
	60	3,700	420	0.034	0.160	5,900	450	0.030	0.080	6,000	300	0.020	0.150
	8	11,500	2,710	0.370	0.900	9,700	1560	0.297	0.600	6,800	1210	0.241	0.600
	10	11,500	2,710	0.370	0.900	9,700	1560	0.297	0.600	6,800	1210	0.241	0.600
	12	11,500	2,710	0.390	0.900	9,700	1560	0.297	0.600	6,800	1210	0.241	0.600
	16	11,500	2,710	0.390	0.900	9,700	1560	0.297	0.600	6,800	1210	0.241	0.600
	20	11,500	2,710	0.390	0.900	9,700	1560	0.297	0.600	6,800	1210	0.241	0.600
	25	10,300	1,850	0.279	0.540	8,400	1250	0.223	0.360	6,000	980	0.180	0.360
R2	30	10,300	1,850	0.279	0.540	8,400	1250	0.223	0.360	6,000	980	0.180	0.361
	35	7,500	1,360	0.185	0.540	6,600	950	0.148	0.360	6,000	700	0.120	0.360
	40	7,500	1,360	0.185	0.540	6,600	950	0.148	0.360	6,000	700	0.120	0.360
	45	5,000	780	0.093	0.360	5,900	470	0.074	0.240	5,600	490	0.060	0.240
	50	5,000	780	0.093	0.360	5,900	470	0.074	0.240	5,600	490	0.060	0.240
	55	4,500	640	0.090	0.330	5,200	375	0.068	0.225	5,400	370	0.050	0.251
	60	4,000	500	0.078	0.300	5,000	280	0.062	0.210	5,200	250	0.040	0.180
	15	9,600	2,590	0.406	0.900	7,800	1350	0.324	0.800	5,600	1050	0.252	0.800
	20	9,600	2,100	0.406	0.900	7,800	1240	0.324	0.600	5,600	950	0.252	0.600
	25	9,600	2,100	0.406	0.900	7,800	1240	0.324	0.600	5,600	950	0.252	0.600
	30	8,200	1,320	0.305	0.900	7,800	760	0.243	0.600	4,800	600	0.197	0.600
	40	7,000	830	0.230	0.900	7,800	470	0.200	0.600	4,300	380	0.154	0.600
R2.5	45	5,000	520	0.173	0.900	6,800	290	0.165	0.600	3,900	240	0.120	0.600
	50	4,500	330	0.131	0.900	6,800	180	0.135	0.600	3,500	150	0.094	0.600
	60	4,000	300	0.099	0.800	6,800	110	0.112	0.600	3,300	100	0.074	0.600
	15	8,000	2,530	0.555	1.800	7,400	2088	0.443	1.200	5,200	1300	0.360	1.200
R3	30	8,000	1,810	0.418	1.080	7,400	1875	0.334	0.720	4,600	1170	0.270	0.720
	25	9,000	2,400	0.600	1.500	7,200	1500	0.500	1.000	5,200	920	0.350	1.000
R4	30	7,700	1,500	0.450	1.200	7,200	925	0.380	0.800	4,500	580	0.300	0.800
	30	7,800	1,300	0.300	0.900	6,800	900	0.230	0.600	4,600	570	0.190	0.570
R5	35	7,125	1,292	0.176	0.513	6,800	860	0.140	0.340	5,700	665	0.110	0.340
	30	7,410	1,235	0.285	0.855	6,350	855	0.210	0.570	4,370	541	0.181	0.550
R6	40	6,800	1,100	0.260	0.780	6,350	788	0.200	0.520	4,020	500	0.160	0.500

절입량  
Depth of Cut

- Ap : Axial Depth
- Ae : Radial Depth
- D : Outside Diameter
- n : Speed
- Vf : Feed

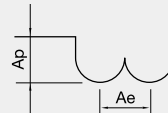

- 유효장 길이가 긴 경우, RPM과 FEED를 동일 비율로 낮춰주세요.
- 절삭조건이 없는 직경 및 유효장은 비슷한 직경 및 유효장에 비례하여 UP&DOWN 하여 설정 하십시오.
- HRC52 이상 고경도강 가공시 같은 직경의 같은 비율로 20% DOWN 시켜주세요.
- 상기 절삭조건은 참고 수치이므로 실 가공시 가공 형상, 가공 목적, 적용 기계에 따라 조건변경 요망 합니다.
- 적용 기계의 회전 속도가 부족한 경우에는 회전 속도와 이송 속도를 같은 비율로 줄여서 적용합니다.
- 진동이 적고 강성이 좋은 공작기계 사용 요망 합니다 (Ø1이하 사용시 진동 허용 관리 5µm 이내 일것.)
- 원활한 칩배출을 위하여 에어브로 혹은 미스트 콜러트 사용을 추천하며, 동 가공시 습식 콜러트를 추천 합니다.
- If the effective length is long, reduce the RPM and feed in the same proportion.
- If the effective length or overall length of your tool are not show above the table, adjust your parameter with upper or lower diameter of parameter.
- When milling workpiece HRC over 52 hardened steel , reduce 20% of the RPM and feed compared to the same diameter.
- Use this table for your reference. Adjust the parameters depending on your machining geometry, machining purpose and CNC.
- If the table over the maximum RPM and feed of your machine, adjust RPM and feed in the same proportion.
- Use a machine with low vibration and good rigidity (Ø1 or less, the vibration tolerance management should be within 5µm).
- Air blow or oil mist is recommended for smooth chip emission, and wet coolant milling is recommended for copper material.

피삭재 Material		동 합금 Copper alloys C1100				합금강 / 프리하드강 Alloy Steels / Prehardened Steels NAK80/KP4M				고경도강 Hardened Steels STAVAX/SKD11			
경도 Hardness		40 ~ 45HRC								45 ~ 55HRC			
반경 Radius	유효장 Effective Length	RPM	FEED	Ap Axial Depth	Ae Radial Depth	RPM	FEED	Ap Axial Depth	Ae Radial Depth	RPM	FEED	Ap Axial Depth	Ae Radial Depth
R0.05	0.2	54,000	360	0.010	0.050	43,200	306	0.009	0.045	34,560	245	0.007	0.036
R0.075	0.15	54,000	456	0.010	0.030	43,200	388	0.009	0.027	34,560	310	0.007	0.022
R0.1	0.2	54,000	516	0.012	0.008	43,200	439	0.011	0.007	34,560	351	0.009	0.006
	0.4	54,000	516	0.005	0.008	43,200	439	0.005	0.007	34,560	351	0.004	0.006
R0.1.5	0.3	54,000	864	0.020	0.013	43,200	734	0.018	0.012	34,560	588	0.014	0.009
	0.6	54,000	864	0.010	0.013	43,200	734	0.009	0.012	34,560	588	0.007	0.009
R0.2	0.4	54,000	1,044	0.028	0.016	43,200	887	0.025	0.014	34,560	710	0.020	0.012
	0.8	54,000	1,044	0.014	0.016	43,200	887	0.013	0.014	34,560	710	0.010	0.012
R0.25	0.5	56,000	1,500	0.035	0.022	44,800	1,275	0.032	0.020	35,840	1,020	0.025	0.016
R0.3	0.6	58,000	1,812	0.042	0.026	46,400	1,540	0.038	0.023	37,120	1,232	0.030	0.019
R0.35	0.7	55,000	2,028	0.049	0.031	44,000	1,724	0.044	0.028	35,200	1,379	0.035	0.022
R0.4	0.8	52,000	2,244	0.056	0.036	41,600	1,907	0.050	0.032	33,280	1,526	0.040	0.026
	2	52,000	2,244	0.033	0.036	41,600	1,907	0.015	0.032	33,280	1,526	0.012	0.026
R0.5	1	41,000	1,992	0.063	0.040	32,800	1,693	0.057	0.036	26,240	1,355	0.045	0.029
	2.5	41,000	1,992	0.022	0.040	32,800	1,693	0.020	0.036	26,240	1,355	0.016	0.029
R0.6	3	34,000	2,088	0.065	0.040	27,200	1,775	0.059	0.036	21,760	1,420	0.047	0.029
R0.75	1.5	27,000	2,196	0.087	0.068	21,600	1,867	0.078	0.061	17,280	1,493	0.063	0.049
	4	27,000	2,196	0.052	0.068	21,600	1,867	0.047	0.061	17,280	1,493	0.037	0.049
R1	2	20,000	2,136	0.112	0.089	16,000	1,816	0.101	0.080	12,800	1,452	0.081	0.064
	5	20,000	2,136	0.070	0.091	16,000	1,816	0.063	0.082	12,800	1,452	0.050	0.066
R1.25	6	16,000	2,208	0.067	0.115	12,800	1,877	0.060	0.104	10,240	1,501	0.048	0.083
R1.5	3	13,000	2,664	0.197	0.171	10,400	2,264	0.177	0.154	8,320	1,812	0.142	0.123
	8	13,000	2,664	0.100	0.171	10,400	2,264	0.090	0.154	8,320	1,812	0.072	0.123
R1.75	8	11,500	2,580	0.183	0.190	9,200	2,193	0.165	0.171	7,360	1,754	0.132	0.136
R2	4	10,000	2,496	0.266	0.208	8,000	2,122	0.239	0.187	6,400	1,697	0.192	0.150
	8	10,000	2,496	0.134	0.208	8,000	2,122	0.121	0.187	6,400	1,697	0.096	0.150
R2.5	5	8,300	2,388	0.215	0.240	6,640	2,030	0.194	0.216	5,312	1,624	0.155	0.173
	8	8,300	2,388	0.200	0.240	6,640	2,030	0.180	0.216	5,312	1,624	0.144	0.173
	10	8,300	2,388	0.190	0.240	6,640	2,030	0.171	0.216	5,312	1,624	0.137	0.173
R3	6	6,900	2,328	0.290	0.281	5,520	1,979	0.261	0.253	4,416	1,583	0.209	0.202
	10	6,900	2,328	0.250	0.281	5,520	1,979	0.225	0.253	4,416	1,583	0.180	0.202
R3.5	12	6,900	2,328	0.230	0.281	5,520	1,979	0.207	0.253	4,416	1,583	0.166	0.202
	14	6,310	2,200	0.315	0.228	5,048	1,499	0.284	0.205	4,038	1,200	0.227	0.164
R4	8	5,720	2,000	0.400	0.175	4,576	1,020	0.360	0.158	3,661	816	0.288	0.126
	14	5,720	2,188	0.400	0.175	4,576	1,020	0.360	0.158	3,661	816	0.288	0.126
R4.5	16	5,135	2,125	0.450	0.165	4,108	867	0.405	0.148	3,286	694	0.324	0.118
R5	10	4,550	2,063	0.500	0.154	3,640	714	0.450	0.139	2,912	571	0.360	0.111
	15	4,550	2,063	0.500	0.154	3,640	714	0.450	0.139	2,912	571	0.360	0.111
	18	4,550	2,063	0.500	0.154	3,640	714	0.450	0.139	2,912	571	0.360	0.111
R5.5	20	4,160	1,950	0.550	0.157	3,328	663	0.495	0.141	2,662	530	0.396	0.113
R6	18	3,770	1,925	0.600	0.159	3,016	612	0.540	0.143	2,413	490	0.432	0.114
	22	3,770	1,875	0.600	0.159	3,016	612	0.540	0.143	2,413	490	0.432	0.114
R6.5	24	3,728	1,850	0.549	0.156	2,982	666	0.494	0.140	2,386	533	0.395	0.112
R7	24	3,686	1,788	0.498	0.153	2,948	720	0.448	0.137	2,359	576	0.359	0.110
R8	30	2,985	1,750	0.413	0.147	2,388	612	0.372	0.132	1,911	490	0.298	0.106
R10	38	2,429	1,688	0.276	0.133	1,943	367	0.248	0.120	1,554	294	0.198	0.096

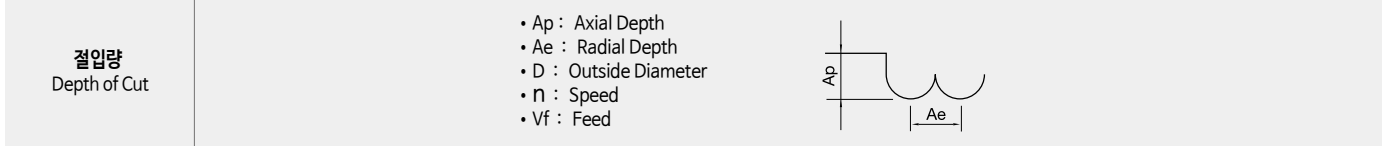

- 유효장 길이가 긴 경우, RPM과 FEED를 동일 비율로 낮춰 주세요.
- 절삭조건이 없는 직경 및 유효장은 비슷한 직경 및 유효장에 비례하여 UP&DOWN 하여 설정 하십시오.
- HRC52 이상 고경도강 가공시 같은 직경의 같은 비율로 20% DOWN 시켜주십시오.
- 상기 절삭조건은 참고 수치이므로 실 가공시 가공 형상, 가공 목적, 적용 기계에 따라 조건 변경 요망합니다.
- 적용 기계의 회전 속도가 부족한 경우에는 회전 속도와 이송속도를 같은 비율로 줄여서 적용합니다.
- 진동이 적고 강성이 좋은 공작기계 사용 요망 합니다 (Ø1이하 사용자 진동 허용 관리 5µm 이내 일것.)
- 원활한 칩 배출을 위하여 에어브로 혹은 미스트쿨러트 사용을 추천하며, 동 가공시 습식 쿨러트를 추천 합니다.
- If the effective length is long, reduce the RPM and feed in the same proportion.
- If the effective length or overall length of your tool are not show above the table, adjust your parameter with upper or lower diameter of parameter.
- When milling workpiece HRC over 52 hardened steel , reduce 20% of the RPM and feed compared to the same diameter.
- Use this table for your reference. Adjust the parameters depending on your machining geometry, machining purpose and CNC.
- If the table over the maximum RPM and feed of your machine, adjust RPM and feed in the same proportion.
- Use a machine with low vibration and good rigidity (Ø1 or less, the vibration tolerance management should be within 5µm).
- Air blow or oil mist is recommended for smooth chip emission, and wet coolant milling is recommended for copper material.

피삭재 Material		동 합금 Copper alloys C1100				합금강 / 프리하드강 Alloy Steels / Prehardened Steels NAK80/KP4M				고경도강 Hardened Steels STAVAX/SKD11			
경도 Hardness						40 ~ 45HRC				45 ~ 55HRC			
외경 Outside Diameter	유효장 Effective Length	RPM	FEED	Ap Axial Depth	Ae Radial Depth	RPM	FEED	Ap Axial Depth	Ae Radial Depth	RPM	FEED	Ap Axial Depth	Ae Radial Depth
∅ 0.1	0.3	56,000	544	0.006	0.020	47,600	435	0.005	0.018	42,840	392	0.005	0.015
"	0.5	50,900	464	0.005	0.016	43,265	371	0.005	0.014	38,939	334	0.004	0.012
∅ 0.2	0.5	56,000	544	0.006	0.020	47,600	435	0.005	0.018	42,840	392	0.005	0.015
"	1	50,900	464	0.005	0.016	43,265	371	0.005	0.014	38,939	334	0.004	0.012
"	2	48,200	400	0.003	0.006	40,970	320	0.003	0.005	36,873	288	0.002	0.005
∅ 0.3	1	60,000	896	0.009	0.101	51,000	717	0.008	0.091	45,900	645	0.007	0.077
"	1.5	50,800	736	0.008	0.057	43,180	589	0.007	0.051	38,862	530	0.006	0.044
"	2	41,500	560	0.006	0.013	35,275	448	0.005	0.012	31,748	403	0.005	0.010
"	3	31,900	384	0.002	0.004	27,115	307	0.002	0.004	24,404	276	0.002	0.003
"	4	26,200	272	0.001	0.003	22,270	218	0.001	0.003	20,043	196	0.001	0.002
"	5	20,400	160	0.001	0.002	17,340	128	0.001	0.002	15,606	115	0.001	0.002
∅ 0.4	1	52,700	1,056	0.012	0.054	44,795	845	0.011	0.049	40,316	760	0.009	0.041
"	5	38,500	608	0.003	0.003	32,725	486	0.003	0.003	29,453	438	0.002	0.002
"	10	33,700	416	0.001	0.001	28,645	333	0.001	0.001	25,781	300	0.001	0.001
∅ 0.5	2	56,800	1,440	0.020	0.098	48,280	1,152	0.018	0.088	43,452	1,037	0.015	0.075
"	3	44,200	1,056	0.009	0.016	37,570	845	0.008	0.014	33,813	760	0.007	0.012
"	4	40,600	928	0.008	0.012	34,510	742	0.008	0.011	31,059	668	0.006	0.009
"	5	37,000	800	0.008	0.008	31,450	640	0.007	0.007	28,305	576	0.006	0.006
"	6	33,400	672	0.005	0.004	28,390	538	0.005	0.004	25,551	484	0.004	0.003
"	8	29,100	512	0.002	0.002	24,735	410	0.002	0.002	22,262	369	0.002	0.002
"	10	26,100	400	0.001	0.001	22,185	320	0.001	0.001	19,967	288	0.001	0.001
"	14	21,500	192	0.001	0.001	18,275	154	0.001	0.001	16,448	138	0.001	0.001
∅ 0.6	2	63,600	1,984	0.025	0.203	54,060	1,587	0.023	0.183	48,654	1,428	0.019	0.155
"	3	52,500	1,584	0.018	0.114	44,625	1,267	0.016	0.103	40,163	1,140	0.014	0.087
"	4	41,300	1,184	0.012	0.025	35,105	947	0.011	0.023	31,595	852	0.009	0.019
"	5	36,700	1,008	0.010	0.017	31,195	806	0.009	0.015	28,076	726	0.008	0.013
"	6	32,100	832	0.007	0.008	27,285	666	0.006	0.007	24,557	599	0.005	0.006
"	8	26,800	624	0.004	0.003	22,780	499	0.004	0.003	20,502	449	0.003	0.002
"	10	23,400	48	0.002	0.002	19,890	38	0.002	0.002	17,901	35	0.002	0.002
"	12	20,900	384	0.002	0.001	17,765	307	0.002	0.001	15,989	276	0.002	0.001
"	16	16,200	160	0.001	0.001	13,770	128	0.001	0.001	12,393	115	0.001	0.001
∅ 0.7	2	59,800	2,208	0.030	0.055	50,830	1,766	0.027	0.050	45,747	1,590	0.023	0.042
"	4	38,900	1,344	0.017	0.047	33,065	1,075	0.015	0.042	29,759	968	0.013	0.036
"	6	30,200	960	0.010	0.014	25,670	768	0.009	0.013	23,103	691	0.008	0.011
"	8	25,300	736	0.006	0.006	21,505	589	0.005	0.005	19,355	530	0.005	0.005
"	10	22,000	576	0.004	0.003	18,700	461	0.004	0.003	16,830	415	0.003	0.002
∅ 0.8	2	41,200	1,680	0.033	0.108	35,020	1,344	0.030	0.097	31,518	1,210	0.025	0.083
"	4	37,100	1,488	0.027	0.08	31,535	1,190	0.024	0.072	28,382	1,071	0.021	0.061
"	6	28,800	1,088	0.015	0.024	24,480	870	0.014	0.022	22,032	783	0.011	0.018
"	8	24,100	832	0.009	0.01	20,485	666	0.008	0.009	18,437	599	0.007	0.008
"	10	21,000	672	0.006	0.005	17,850	538	0.005	0.005	16,065	484	0.005	0.004
"	12	18,700	544	0.004	0.003	15,895	435	0.004	0.003	14,306	392	0.003	0.002
"	14	15,600	368	0.002	0.001	13,260	294	0.002	0.001	11,934	265	0.002	0.001
∅ 0.9	6	27,600	1,264	0.019	0.019	23,460	1,011	0.017	0.017	21,114	910	0.015	0.015
"	8	23,000	960	0.012	0.012	19,550	768	0.011	0.011	17,595	691	0.009	0.009
"	10	20,000	752	0.008	0.008	17,000	602	0.007	0.007	15,300	541	0.006	0.006
∅ 1.0	2	37,900	2,144	0.048	0.263	30,320	1,822	0.038	0.210	27,288	1,640	0.033	0.179
"	3	37,900	2,144	0.048	0.263	30,320	1,822	0.038	0.210	27,288	1,640	0.033	0.179
"	4	34,100	1,872	0.040	0.195	27,280	1,591	0.032	0.156	24,552	1,432	0.027	0.133
"	5	30,300	1,600	0.032	0.083	24,240	1,360	0.026	0.066	21,816	1,224	0.022	0.056
"	6	26,500	1,360	0.023	0.058	21,200	1,156	0.018	0.046	19,080	1,040	0.016	0.039
"	8	22,100	1,056	0.014	0.024	17,680	898	0.011	0.019	15,912	808	0.010	0.016
"	10	19,200	848	0.010	0.013	15,360	721	0.008	0.010	13,824	649	0.007	0.009
"	12	17,200	704	0.007	0.007	13,760	598	0.006	0.006	12,384	539	0.005	0.005
"	14	15,600	576	0.005	0.005	12,480	490	0.004	0.004	11,232	441	0.003	0.003
"	16	14,300	480	0.004	0.003	11,440	408	0.003	0.002	10,296	367	0.003	0.002
"	20	12,500	320	0.003	0.001	10,000	272	0.002	0.001	9,000	245	0.002	0.001
"	25	10,800	192	0.003	0.001	8,640	163	0.002	0.001	7,776	147	0.002	0.001
"	30	9,700	80	0.002	0.001	7,760	68	0.002	0.001	6,984	61	0.001	0.001
∅ 1.2	4	28,900	1,888	0.050	0.189	23,120	1,605	0.040	0.151	20,808	1,444	0.034	0.129
"	6	24,800	1,552	0.037	0.120	19,840	1,319	0.030	0.096	17,856	1,187	0.025	0.082
"	8	20,700	1,216	0.024	0.051	16,560	1,034	0.019	0.041	14,904	930	0.016	0.035
"	10	18,000	992	0.016	0.026	14,400	843	0.013	0.021	12,960	759	0.011	0.018
"	12	16,100	832	0.011	0.015	12,880	707	0.009	0.012	11,592	636	0.007	0.010
"	16	13,400	608	0.006	0.006	10,720	517	0.005	0.005	9,648	465	0.004	0.004
"	20	11,700	448	0.004	0.003	9,360	381	0.003	0.002	8,424	343	0.003	0.002
"	25	10,800	192	0.003	0.001	8,640	163	0.002	0.001	7,776	147	0.002	0.001
"	30	9,700	80	0.002	0.001	7,760	68	0.002	0.001	6,984	61	0.001	0.001

피삭재 Material		동 합금 Copper alloys C1100				합금강 / 프리하드강 Alloy Steels / Prehardened Steels NAK80/KP4M				고경도강 Hardened Steels STAVAX/SKD11			
경도 Hardness		40 ~ 45Hrc								45 ~ 55Hrc			
외경 Outside Diameter	유효장 Effective Length	RPM	FEED	Ap Axial Depth	Ae Radial Depth	RPM	FEED	Ap Axial Depth	Ae Radial Depth	RPM	FEED	Ap Axial Depth	Ae Radial Depth
∅ 1.4	6	23,300	1,712	0.052	0.222	18,640	1,455	0.042	0.178	16,776	1,310	0.035	0.151
"	8	19,500	1,360	0.035	0.094	15,600	1,156	0.028	0.075	14,040	1,040	0.024	0.064
"	10	16,900	1,136	0.025	0.048	13,520	966	0.020	0.038	12,168	869	0.017	0.033
"	14	13,700	816	0.013	0.018	10,960	694	0.010	0.014	9,864	624	0.009	0.012
"	16	12,600	720	0.010	0.012	10,080	612	0.008	0.010	9,072	551	0.007	0.008
"	20	10,300	480	0.006	0.005	8,240	408	0.005	0.004	7,416	367	0.004	0.003
∅ 1.5	4	26,600	2,144	0.073	0.462	21,280	1,822	0.058	0.370	19,152	1,640	0.050	0.314
"	6	22,800	1,792	0.057	0.293	18,240	1,523	0.046	0.234	16,416	1,371	0.039	0.199
"	8	19,000	1,440	0.041	0.124	15,200	1,224	0.033	0.099	13,680	1,102	0.028	0.084
"	10	16,600	1,200	0.030	0.063	13,280	1,020	0.024	0.050	11,952	918	0.020	0.043
"	12	14,800	1,008	0.023	0.037	11,840	857	0.018	0.030	10,656	771	0.016	0.025
"	14	13,400	880	0.017	0.023	10,720	748	0.014	0.018	9,648	673	0.012	0.016
"	16	12,300	768	0.013	0.015	9,840	653	0.010	0.012	8,856	588	0.009	0.010
"	18	11,500	672	0.011	0.011	9,200	571	0.009	0.009	8,280	514	0.007	0.007
"	20	10,700	592	0.009	0.008	8,560	503	0.007	0.006	7,704	453	0.006	0.005
"	25	9,300	432	0.005	0.004	7,440	367	0.004	0.003	6,696	330	0.003	0.003
"	30	8,300	320	0.004	0.002	6,640	272	0.003	0.002	5,976	245	0.003	0.001
∅ 1.6	10	16,100	1,248	0.035	0.082	12,880	1,061	0.028	0.066	11,592	955	0.024	0.056
"	14	13,000	928	0.020	0.030	10,400	789	0.016	0.024	9,360	710	0.014	0.020
"	18	11,100	720	0.013	0.014	8,880	612	0.010	0.011	7,992	551	0.009	0.010
∅ 2.0	4	23,000	2,400	0.070	0.966	18,400	2,040	0.056	0.773	16,560	1,836	0.048	0.657
"	6	20,300	2,160	0.064	0.926	16,240	1,836	0.051	0.741	14,616	1,652	0.044	0.630
"	8	17,000	1,744	0.054	0.391	13,600	1,482	0.043	0.313	12,240	1,334	0.037	0.266
"	10	14,800	1,472	0.045	0.200	11,840	1,251	0.036	0.160	10,656	1,126	0.031	0.136
"	12	13,200	1,264	0.037	0.116	10,560	1,074	0.030	0.093	9,504	967	0.025	0.079
"	14	12,000	1,120	0.031	0.073	9,600	952	0.025	0.058	8,640	857	0.021	0.050
"	16	11,100	992	0.026	0.049	8,880	843	0.021	0.039	7,992	759	0.018	0.033
"	18	10,300	880	0.022	0.034	8,240	748	0.018	0.027	7,416	673	0.015	0.023
"	20	9,600	800	0.018	0.025	7,680	680	0.014	0.020	6,912	612	0.012	0.017
"	22	8,700	672	0.014	0.018	6,960	571	0.011	0.014	6,264	514	0.010	0.012
"	25	8,400	624	0.012	0.013	6,720	530	0.010	0.010	6,048	477	0.008	0.009
"	30	7,500	496	0.008	0.007	6,000	422	0.006	0.006	5,400	379	0.005	0.005
∅ 2.5	8	15,000	2,144	0.077	0.954	12,000	1,822	0.062	0.763	10,800	1,640	0.052	0.649
"	10	13,100	1,824	0.068	0.488	10,480	1,550	0.054	0.390	9,432	1,395	0.046	0.332
"	12	11,800	1,600	0.060	0.283	9,440	1,360	0.048	0.226	8,496	1,224	0.041	0.192
"	16	9,900	1,264	0.045	0.119	7,920	1,074	0.036	0.095	7,128	967	0.031	0.081
"	20	8,700	1,040	0.033	0.061	6,960	884	0.026	0.049	6,264	796	0.022	0.041
"	25	7,600	832	0.022	0.031	6,080	707	0.018	0.025	5,472	636	0.015	0.021
"	30	6,800	688	0.014	0.018	5,440	585	0.011	0.014	4,896	526	0.010	0.012
"	35	6,200	608	0.009	0.012	4,960	517	0.007	0.010	4,464	465	0.006	0.008
"	40	5,700	464	0.005	0.008	4,560	394	0.004	0.006	4,104	355	0.003	0.005
"	50	5,000	304	0.001	0.004	4,000	258	0.001	0.003	3,600	233	0.001	0.003
∅ 3	6	13,200	2,352	0.103	1.978	10,560	1,999	0.082	1.582	9,504	1,799	0.070	1.345
"	10	11,600	2,032	0.092	1.013	9,280	1,727	0.074	0.810	8,352	1,554	0.063	0.689
"	12	10,500	1,776	0.081	0.586	8,400	1,510	0.065	0.469	7,560	1,359	0.055	0.398
"	16	8,900	1,440	0.064	0.247	7,120	1,224	0.051	0.198	6,408	1,102	0.044	0.168
"	20	7,800	1,200	0.050	0.127	6,240	1,020	0.040	0.102	5,616	918	0.034	0.086
"	25	6,900	992	0.036	0.065	5,520	843	0.029	0.052	4,968	759	0.024	0.044
"	30	6,200	832	0.026	0.038	4,960	707	0.021	0.030	4,464	636	0.018	0.026
"	35	5,700	704	0.018	0.024	4,560	598	0.014	0.019	4,104	539	0.012	0.016
"	40	5,300	592	0.013	0.016	4,240	503	0.010	0.013	3,816	453	0.009	0.011
"	45	5,000	528	0.008	0.012	4,000	449	0.006	0.010	3,600	404	0.005	0.008
"	50	4,700	432	0.006	0.008	3,760	367	0.005	0.006	3,384	330	0.004	0.005
"	60	4,500	400	0.003	0.005	3,600	340	0.002	0.004	3,240	306	0.002	0.003
∅ 4	8	10,000	2,560	0.140	1.990	8,000	2,176	0.112	1.592	7,200	1,958	0.095	1.353
"	10	9,200	2,240	0.120	1.960	7,360	1,904	0.096	1.568	6,624	1,714	0.082	1.333
"	12	8,500	2,048	0.112	1.852	6,800	1,741	0.090	1.482	6,120	1,567	0.076	1.259
"	16	7,200	1,680	0.093	0.781	5,760	1,428	0.074	0.625	5,184	1,285	0.063	0.531
"	20	6,300	1,408	0.077	0.400	5,040	1,197	0.062	0.320	4,536	1,077	0.052	0.272
"	25	5,600	1,200	0.061	0.205	4,480	1,020	0.049	0.164	4,032	918	0.041	0.139
"	30	5,000	1,008	0.048	0.119	4,000	857	0.038	0.095	3,600	771	0.033	0.081
"	35	4,600	864	0.038	0.075	3,680	734	0.030	0.060	3,312	661	0.026	0.051
"	40	4,200	752	0.030	0.050	3,360	639	0.024	0.040	3,024	575	0.020	0.034
"	45	3,900	656	0.023	0.035	3,120	558	0.018	0.028	2,808	502	0.016	0.024
"	50	3,700	576	0.018	0.026	2,960	490	0.014	0.021	2,664	441	0.012	0.018
"	55	3,500	512	0.015	0.020	2,800	435	0.012	0.016	2,520	392	0.010	0.014
"	60	3,300	448	0.011	0.015	2,640	381	0.009	0.012	2,376	343	0.007	0.010

피삭재 Material		동 합금 Copper alloys C1100				합금강 / 프리하드강 Alloy Steels / Prehardened Steels NAK80/KP4M				고경도강 Hardened Steels STAVAX/SKD11			
경도 Hardness						40 ~ 50HRC				50 ~ 52HRC			
외경 Outside Diameter	유효장 Effective Length	RPM	FEED	Ap Axial Depth	Ae Radial Depth	RPM	FEED	Ap Axial Depth	Ae Radial Depth	RPM	FEED	Ap Axial Depth	Ae Radial Depth
∅ 5	16	6,000	1,824	0.127	1.907	4,800	1,550	0.102	1.526	4,320	1,395	0.086	1.297
"	20	5,300	1,568	0.121	0.977	4,240	1,333	0.097	0.782	3,816	1,200	0.082	0.664
"	25	4,600	1,312	0.109	0.500	3,680	1,115	0.087	0.400	3,312	1,004	0.074	0.340
"	30	4,200	1,136	0.094	0.289	3,360	966	0.075	0.231	3,024	869	0.064	0.197
"	35	3,800	992	0.077	0.182	3,040	843	0.062	0.146	2,736	759	0.052	0.124
"	40	3,500	864	0.060	0.122	2,800	734	0.048	0.098	2,520	661	0.041	0.083
"	50	3,100	688	0.031	0.063	2,480	585	0.025	0.050	2,232	526	0.021	0.043
"	60	2,800	560	0.013	0.036	2,240	476	0.010	0.029	2,016	428	0.009	0.024
∅ 6	20	4,200	1,536	0.126	2.025	3,360	1,306	0.101	1.620	3,024	1,175	0.086	1.377
"	30	3,400	1,168	0.109	0.600	2,720	993	0.087	0.480	2,448	894	0.074	0.408
"	40	3,000	960	0.083	0.253	2,400	816	0.066	0.202	2,160	734	0.056	0.172
"	50	2,600	768	0.054	0.130	2,080	653	0.043	0.104	1,872	588	0.037	0.088
"	60	2,400	656	0.031	0.075	1,920	558	0.025	0.060	1,728	502	0.021	0.051
∅ 8	20	3,200	1,456	0.180	1.600	2,560	1,238	0.144	1.280	2,304	1,114	0.122	1.088
"	40	2,600	960	0.120	0.200	2,080	816	0.096	0.160	1,872	734	0.082	0.136
∅ 10	25	2,900	1,424	0.200	1.760	2,320	1,210	0.160	1.408	2,088	1,089	0.136	1.197
"	45	2,200	928	0.140	0.240	1,760	789	0.112	0.192	1,584	710	0.095	0.163
∅ 12	30	2,000	1,296	0.190	1.650	1,600	1,102	0.152	1.320	1,440	991	0.129	1.122
"	50	1,950	912	0.150	0.250	1,560	775	0.120	0.200	1,404	698	0.102	0.170

절입량 Depth of Cut	Slotting	
	• Ap : Axial Depth • D : Outside Diameter	
	Side Milling	
	• Ap : Axial Depth • Ae : Radial Depth	

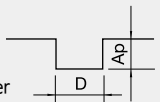
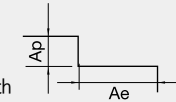
- 날 끝이 정밀하게 연삭되어 있습니다. 파손을 피하기 위해 가능하면 비접촉 방식으로 측정 하십시오.
- HRC52 이상 고경도강 가공시 같은 직경의 같은 비율로 20% DOWN 시켜주십시오.
- 상기 절삭조건은 참고 수치이며 실 가공시 가공 형상, 가공 목적, 적용 기계에 따라 조건변경 요망 합니다.
- 조건표가 기계의 최대 스피들 속도를 초과 하거나 버 및 적열 현상이 발생할때 스피들 속도와 이송 속도를 비례하여 조정 하십시오.
- 진동이 적고 강성이 좋은 공작기계 사용 요망 합니다 (∅1이하 사용시 진동 허용 관리 5 $\mu$ m 이내 일것.)
- 에어브로, 절삭유, 오일 미스트 클린트를 추천하며, 칩을 잘 제거하고 가공시 발열과 발화에 주의 하십시오
- The edge of the flute precisely grinded. If you want to measure the tool, and to avoid damaging on the flutes, use non-contact measuring method.
- When milling workpiece HRC over 52 hardened steel, reduce 20% of the RPM and feed compared to the same diameter.
- Use this table for your reference. Adjust the parameters depending on your machining geometry, machining purpose and CNC.
- If the table over the maximum RPM and feed of your machine, or found red heat on the material, adjust RPM and feed in the same proportion.
- Use a machine with low vibration and good rigidity ( $\varnothing 1$  or less, the vibration tolerance management should be within 5 $\mu$ m).
- Air blow or mist coolants are recommended and note for chip emission, heat, or ignition.

피삭재 Material		동 합금 Copper alloys C1100				합금강 / 프리하드강 Alloy Steels / Prehardened Steels NAK80/KP4M				고경도강 Hardened Steels STAVAX/SKD11			
경도 Hardness		40 ~ 45HRC								45 ~ 55HRC			
외경 Outside Diameter	유효장 Effective Length	RPM	FEED	Ap Axial Depth	Ae Radial Depth	RPM	FEED	Ap Axial Depth	Ae Radial Depth	RPM	FEED	Ap Axial Depth	Ae Radial Depth
∅ 0.8	8	24,100	1,235	0.009	0.01	20,485	988	0.008	0.01	18,430	840	0.006	0.01
"	12	18,700	707	0.004	0.003	15,895	566	0.004	0.003	14,306	481	0.003	0.002
∅ 1	8	22,100	1,373	0.014	0.024	17,680	1,098	0.011	0.019	15,912	934	0.010	0.016
"	16	14,300	624	0.004	0.003	11,440	499	0.003	0.002	10,296	424	0.003	0.002
"	25	10,800	250	0.003	0.001	8,640	200	0.002	0.001	7,776	170	0.002	0.001
∅ 1.5	8	19,000	1,872	0.041	0.124	15,200	1,498	0.033	0.099	13,680	1,273	0.028	0.084
"	16	12,300	998	0.013	0.015	9,840	799	0.010	0.012	8,856	679	0.009	0.010
"	25	9,300	562	0.005	0.004	7,440	449	0.004	0.003	6,696	382	0.003	0.003
∅ 2	8	17,000	2,267	0.054	0.391	13,600	1,814	0.043	0.313	12,240	1,542	0.037	0.266
"	16	11,100	1,290	0.026	0.049	8,880	1,032	0.021	0.039	7,992	877	0.018	0.033
"	25	8,400	811	0.012	0.013	6,720	649	0.010	0.010	6,048	552	0.008	0.009
∅ 2.5	10	13,100	2,371	0.068	0.488	10,480	1,897	0.054	0.390	9,432	1,612	0.046	0.332
"	16	9,900	1,643	0.045	0.119	7,920	1,315	0.036	0.095	7,128	1,117	0.031	0.081
"	30	6,800	894	0.014	0.018	5,440	716	0.011	0.014	4,896	608	0.010	0.012
∅ 3	10	11,600	2,642	0.092	1.013	9,280	2,113	0.074	0.810	8,352	1,796	0.063	0.689
"	16	8,900	1,872	0.064	0.247	7,120	1,498	0.051	0.198	6,408	1,273	0.044	0.168
"	25	6,900	1,290	0.036	0.065	5,520	1,032	0.029	0.052	4,968	877	0.024	0.044
"	35	5,700	915	0.018	0.024	4,560	732	0.014	0.019	4,104	622	0.012	0.016
∅ 4	10	9,200	2,912	0.120	1.960	7,360	2,330	0.096	1.568	6,624	1,980	0.082	1.333
"	16	7,200	2,184	0.093	0.781	5,760	1,747	0.074	0.625	5,184	1,485	0.063	0.531
"	25	5,600	1,560	0.061	0.205	4,480	1,248	0.049	0.164	4,032	1,061	0.041	0.139
"	40	4,200	978	0.030	0.050	3,360	782	0.024	0.040	3,024	665	0.020	0.034
∅ 5	15	6,000	2,371	0.127	1.907	4,800	1,897	0.102	1.526	4,320	1,612	0.086	1.297
"	25	4,600	1,706	0.109	0.500	3,680	1,364	0.087	0.400	3,312	1,160	0.074	0.340
"	40	3,500	1,123	0.060	0.122	2,800	899	0.048	0.098	2,520	764	0.041	0.083
∅ 6	20	4,200	1,997	0.126	2.025	3,360	1,597	0.101	1.620	3,024	1,358	0.086	1.377
"	40	3,000	1,248	0.083	0.253	2,400	998	0.066	0.202	2,160	849	0.056	0.172
∅ 8	20	3,200	1,893	0.180	1.600	2,560	1,514	0.144	1.280	2,304	1,287	0.122	1.088
"	40	2,600	1,248	0.120	0.200	2,080	998	0.096	0.160	1,872	849	0.082	0.136
∅ 10	25	2,900	1,851	0.200	1.760	2,320	1,481	0.160	1.408	2,088	1,259	0.136	1.197
"	45	2,200	1,206	0.140	0.240	1,760	965	0.112	0.192	1,584	820	0.095	0.163
∅ 12	30	2,000	1,685	0.190	1.650	1,600	1,348	0.152	1.320	1,440	1,146	0.129	1.122
"	50	1,950	1,186	0.150	0.250	1,560	948	0.120	0.200	1,404	806	0.102	0.170

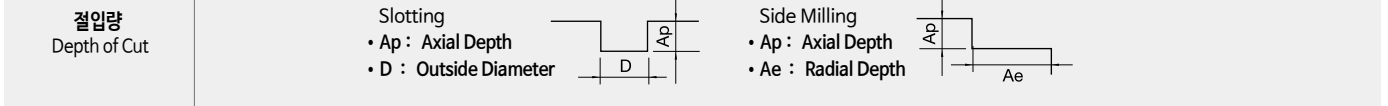

- 날 끝이 정밀하게 연삭되어 있습니다. 파손을 피하기 위해 가능하면 비접촉 방식으로 측정 하십시오.
- HRC52 이상 고경도강 가공시 같은 직경의 같은 비율로 20% DOWN 시켜주십시오.
- 상기 절삭조건은 참고 수치이므로 실 가공시 가공 형상, 가공 목적, 적용 기계에 따라 조건변경 요망 합니다.
- 조건표가 기계의 최대 스피indle 속도를 초과 하거나 버 및 적열 현상이 발생할때 스피indle 속도와 이송속도를 비례하여 조정 하십시오.
- 진동이 적고 강성이 좋은 공작기계 사용 요망 합니다 (∅1이하 사용시 진동 허용 관리 5 $\mu$ m이내 일것.)
- 에어브로, 절삭유, 오일 미스트 콜러트를 추천하며, 칩을 잘 제거하고 가공시 발열과 발화에 주의 하십시오
- The edge of the flute precisely grinded. If you want to measure the tool, and to avoid damaging on the flutes, use non-contact measuring method.
- When milling workpiece HRC over 52 hardened steel, reduce 20% of the RPM and feed compared to the same diameter.
- Use this table for your reference. Adjust the parameters depending on your machining geometry, machining purpose and CNC.
- If the table over the maximum RPM and feed of your machine, or found red heat on the material, adjust RPM and feed in the same proportion.
- Use a machine with low vibration and good rigidity ( $\varnothing 1$  or less, the vibration tolerance management should be within 5 $\mu$ m).
- Air blow or mist coolants are recommended and note for chip emission, heat, or ignition.



홀절삭 Slotting												
피삭재 Material	동 합금 Copper alloys C1100				합금강 / 프리하든강 Alloy Steels / Prehardened Steels NAK80/KP4M				고경도강 Hardened Steels STAVAX/SKD11			
경도 Hardness	40 ~ 45HRc								45 ~ 55HRc			
외경 Outside Diameter	RPM	FEED	Ap Axial Depth	Ae Radial Depth	RPM	FEED	Ap Axial Depth	Ae Radial Depth	RPM	FEED	Ap Axial Depth	Ae Radial Depth
ø 0.1	50,000	300	0.01	0.1	45,000	240	0.08	0.05	40,500	168	0.08	0.05
ø 0.2	50,000	390	0.02	0.2	45,000	312	0.16	0.10	40,500	218	0.16	0.10
ø 0.3	50,000	570	0.03	0.3	45,000	456	0.24	0.15	40,500	319	0.24	0.15
ø 0.4	50,000	705	0.04	0.4	45,000	564	0.32	0.20	40,500	395	0.32	0.20
ø 0.5	50,000	1,110	0.05	0.5	45,000	888	0.40	0.25	40,500	622	0.40	0.25
ø 0.6	50,000	1,410	0.06	0.6	45,000	1,128	0.48	0.30	40,500	790	0.48	0.30
ø 0.8	50,000	1,800	0.08	0.8	40,000	1,440	0.64	0.40	30,000	1,008	0.64	0.40
ø 0.9	49,000	1,965	0.09	0.9	39,000	1,572	0.72	0.45	27,800	1,100	0.72	0.45
ø 1	48,000	2,250	0.10	1.0	38,000	1,800	0.80	0.50	25,500	1,260	0.80	0.50
ø 2	33,300	2,550	0.20	2.0	26,000	2,040	1.60	1.00	17,500	1,428	1.60	1.00
ø 3	21,800	2,550	0.30	3.0	17,300	2,040	2.40	1.50	11,500	1,428	2.40	1.50
ø 4	16,700	2,640	0.40	4.0	13,200	2,112	3.20	2.00	8,800	1,478	3.20	2.00
ø 5	15,700	3,000	0.50	5.0	12,500	2,400	4.00	2.50	8,300	1,680	4.00	2.50
ø 6	13,000	2,850	0.60	6.0	10,350	2,280	4.80	3.00	6,900	1,596	4.80	3.00
ø 8	9,880	2,790	0.80	8.0	7,800	2,232	6.40	4.00	5,200	1,562	6.40	4.00
ø 10	7,800	2,550	1.00	10.0	6,150	2,040	8.00	5.00	4,100	1,428	8.00	5.00
ø 12	6,650	2,550	1.20	12.0	5,250	2,040	9.60	6.00	3,500	1,428	9.60	6.00
ø 16	5,540	2,340	1.60	16.0	4,340	1,872	12.80	8.00	2,600	1,310	12.80	8.00
ø 18	5,540	2,340	1.80	18.0	4,340	1,872	14.40	9.00	2,600	1,310	14.40	9.00
ø 20	4,640	2,160	2.00	20.0	4,340	1,728	16.00	10.00	2,100	1,210	16.00	10.00

절입량 Depth of Cut

~ 40HRC

40HRC ~

측면절삭 Side Cutting												
피삭재 Material	동 합금 Copper alloys C1100				합금강 / 프리하든강 Alloy Steels / Prehardened Steels NAK80/KP4M				고경도강 Hardened Steels STAVAX/SKD11			
경도 Hardness	40 ~ 45HRc								45 ~ 55HRc			
외경 Outside Diameter	RPM	FEED	Ap Axial Depth	Ae Radial Depth	RPM	FEED	Ap Axial Depth	Ae Radial Depth	RPM	FEED	Ap Axial Depth	Ae Radial Depth
ø 1	48,000	1,050	1	0.03	38,000	735	0.50	0.02	25,500	515	0.50	0.02
ø 2	33,300	1,200	2	0.06	26,000	840	1.00	0.04	17,500	588	1.00	0.04
ø 3	21,800	1,200	3	0.09	17,300	840	1.50	0.06	11,500	588	1.50	0.06
ø 4	16,700	1,250	4	0.12	13,200	875	2.00	0.08	8,800	613	2.00	0.08
ø 5	15,700	1,450	5	0.15	12,500	1,015	2.50	0.10	8,300	711	2.50	0.10
ø 6	13,000	1,350	6	0.18	10,350	945	3.00	0.12	6,900	662	3.00	0.12
ø 8	9,880	1,320	8	0.24	7,800	924	4.00	0.16	5,200	647	4.00	0.16
ø 10	7,800	1,200	10	0.30	6,150	840	5.00	0.20	4,100	588	5.00	0.20
ø 12	6,650	1,200	12	0.36	5,250	840	6.00	0.24	3,500	588	6.00	0.24
ø 16	5,540	1,000	16	0.48	4,340	700	8.00	0.32	2,600	490	8.00	0.32
ø 18	5,540	1,000	18	0.54	4,340	700	9.00	0.36	2,600	490	9.00	0.36
ø 20	4,640	950	20	0.60	4,340	760	10.00	0.40	2,100	532	10.00	0.40

절입량 Depth of Cut

~ 40HRC

40HRC ~

- 유효장 길이가 긴 경우, RPM과 FEED를 동일 비율로 낮춰주세요.
- 날 끝이 정밀하게 연삭되어 있습니다. 파손을 피하기 위해 가능하면 비접촉 방식으로 측정하십시오.
- HRC52 이상 고경도강 가공시 같은 직경의 같은 비율로 20% DOWN 해주십시오.
- 상기 절삭조건은 참고 수치이므로 실 가공시 가공 형상, 가공 목적, 적용 기계에 따라 조건변경 요망 합니다.
- 조건표가 기계의 최대 스피들 속도를 초과 하거나 버 및 적열 현상이 발생할때 스피들 속도와 이송 속도를 비례하여 조정 하십시오.
- 진동이 적고 강성이 좋은 공작기계 사용 요망 합니다 (ø1이하 사용자 진동 허용 관리 5µm 이내 일것.)
- 에어브로, 절삭유, 오일 미스트 콜러트를 추천하며, 칩을 잘 제거하고 가공시 발열과 발화에 주의 하십시오
- If the effective length is long, reduce the RPM and feed in the same proportion.
- The edge of the flute precisely grinded. If you want to measure the tool, and to avoid damaging on the flutes, use non-contact measuring method.
- When milling workpiece HRC over 52 hardened steel, reduce 20% of the RPM and feed compared to the same diameter.
- Use this table for your reference. Adjust the parameters depending on your machining geometry, machining purpose and CNC.
- If the table over the maximum RPM and feed of your machine, or found red heat on the material, adjust RPM and feed in the same proportion.
- Use a machine with low vibration and good rigidity (ø1 or less, the vibration tolerance management should be within 5µm).
- Air blow or mist coolants are recommended and note for chip emission, heat, or ignition.

## 홈절삭 Slotting

피삭재 Material	동 합금 Copper alloys C1100				합금강 / 프리하든강 Alloy Steels / Prehardened Steels NAK80/KP4M				고경도강 Hardened Steels STAVAX/SKD11			
	RPM	FEED	Ap Axial Depth	Ae Radial Depth	RPM	FEED	Ap Axial Depth	Ae Radial Depth	RPM	FEED	Ap Axial Depth	Ae Radial Depth
경도 Hardness					40 ~ 45HRC				45 ~ 55HRC			
외경 Outside Diameter	48,000	2,700	0.10	1.0	38,000	2,160	0.80	0.50	25,500	1,512	0.80	0.50
Ø 2	33,300	3,060	0.20	2.0	26,000	2,448	1.60	1.00	17,500	1,714	1.60	1.00
Ø 3	21,800	3,060	0.30	3.0	17,300	2,448	2.40	1.50	11,500	1,714	2.40	1.50
Ø 4	16,700	3,168	0.40	4.0	13,200	2,534	3.20	2.00	8,800	1,774	3.20	2.00
Ø 5	15,700	3,600	0.50	5.0	12,500	2,880	4.00	2.50	8,300	2,016	4.00	2.50
Ø 6	13,000	3,420	0.60	6.0	10,350	2,736	4.80	3.00	6,900	1,915	4.80	3.00
Ø 8	9,880	3,348	0.80	8.0	7,800	2,678	6.40	4.00	5,200	1,875	6.40	4.00
Ø 10	7,800	3,060	1.00	10.0	6,150	2,448	8.00	5.00	4,100	1,714	8.00	5.00
Ø 12	6,650	3,060	1.20	12.0	5,250	2,448	9.60	6.00	3,500	1,714	9.60	6.00
Ø 16	5,540	2,808	1.60	16.0	4,340	2,246	12.80	8.00	2,600	1,572	12.80	8.00
Ø 18	5,540	2,808	1.80	18.0	4,340	2,246	14.40	9.00	2,600	1,572	14.40	9.00
Ø 20	4,640	2,592	2.00	20.0	4,340	2,074	16.00	10.00	2,100	1,452	16.00	10.00



## 측면절삭 Side Cutting

피삭재 Material	동 Copper alloys C1100				합금강 / 프리하든강 Alloy Steels / Prehardened Steels NAK80/KP4M				고경도강 Hardened Steels STAVAX/SKD11			
	RPM	FEED	Ap Axial Depth	Ae Radial Depth	RPM	FEED	Ap Axial Depth	Ae Radial Depth	RPM	FEED	Ap Axial Depth	Ae Radial Depth
경도 Hardness					40 ~ 45HRC				45 ~ 55HRC			
외경 Outside Diameter	48,000	1,155	1	0.03	38,000	809	1	0.03	25,500	566	0.50	0.02
Ø 2	33,300	1,320	2	0.06	26,000	924	2	0.06	17,500	647	1.00	0.04
Ø 3	21,800	1,320	3	0.09	17,300	924	3	0.09	11,500	647	1.50	0.06
Ø 4	16,700	1,375	4	0.12	13,200	963	4	0.12	8,800	674	2.00	0.08
Ø 5	15,700	1,595	5	0.15	12,500	1,117	5	0.15	8,300	782	2.50	0.10
Ø 6	13,000	1,485	6	0.18	10,350	1,040	6	0.18	6,900	728	3.00	0.12
Ø 8	9,880	1,452	8	0.24	7,800	1,016	8	0.24	5,200	711	4.00	0.16
Ø 10	7,800	1,320	10	0.30	6,150	924	10	0.30	4,100	647	5.00	0.20
Ø 12	6,650	1,320	12	0.36	5,250	924	12	0.36	3,500	647	6.00	0.24
Ø 16	5,540	1,100	16	0.48	4,340	770	16	0.48	2,600	539	8.00	0.32
Ø 18	5,540	1,100	18	0.54	4,340	770	18	0.54	2,600	539	9.00	0.36
Ø 20	4,640	1,045	20	0.60	4,340	836	20	0.60	2,100	585	10.00	0.40

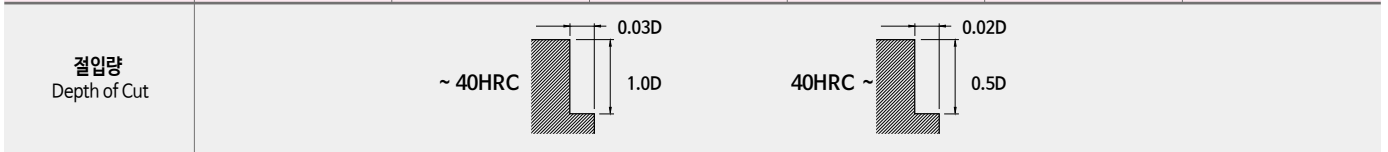

- 유효장 길이가 긴 경우, RPM과 FEED를 동일 비율로 낮춰주세요.
- 날 끝이 정밀하게 연삭되어 있습니다. 파손을 피하기 위해 가능하면 비접촉 방식으로 측정하십시오.
- HRC52 이상 고경도강 가공시 같은 직경의 같은 비율로 20% DOWN 시켜주세요.
- 상기 절삭조건은 참고 수치이므로 실 가공시 가공 형상, 가공 목적, 적용 기계에 따라 조건변경 요망 합니다.
- 조건표가 기계의 최대 스피드 속도를 초과하거나 버 및 적열 현상이 발생할때 스피드 속도와 이송 속도를 비례하여 조정 하십시오.
- 진동이 적고 강성이 좋은 공작기계 사용 요망 합니다 (Ø1이하 사용시 진동 허용 관리 5µm 이내 일것.)
- 에어브로, 절삭유, 오일 미스트 쿨런트를 추천하며, 칩을 잘 제거하고 가공시 발열과 발화에 주의 하십시오
- If the effective length is long, reduce the RPM and feed in the same proportion.
- The edge of the flute precisely grinded. If you want to measure the tool, and to avoid damaging on the flutes, use non-contact measuring method.
- When milling workpiece HRC over 52 hardened steel, reduce 20% of the RPM and feed compared to the same diameter.
- Use this table for your reference. Adjust the parameters depending on your machining geometry, machining purpose and CNC.
- If the table over the maximum RPM and feed of your machine, or found red heat on the material, adjust RPM and feed in the same proportion.
- Use a machine with low vibration and good rigidity (Ø1 or less, the vibration tolerance management should be within 5µm).
- Air blow or mist coolants are recommended and note for chip emission, heat, or ignition.

## 측면절삭 Side Cutting

파삭재 Material	공구강 / 금형강 Tool steels / Mold steels SCM/HPM				합금강 / 프리하든강 Alloy Steels / Pre-hardened Steels NAK80 / KP4M				고경도강 Hardened Steels STAVX / SKD11			
	경도 Hardness				경도 Hardness				경도 Hardness			
외경 Outside Diameter	RPM	FEED	Ap	Ae	RPM	FEED	Ap	Ae	RPM	FEED	Ap	Ae
			Axial Depth	Radial Depth			Axial Depth	Radial Depth			Axial Depth	Radial Depth
∅ 1	40,000	720	1.5	0.05	40,000	660	1.5	0.05	40,000	308	0.5	0.03
∅ 1.5	40,000	900	2.25	0.075	40,000	750	2.25	0.075	38,500	350	0.75	0.045
∅ 2	40,000	1,200	3	0.1	38,000	1,080	3	0.1	36,500	504	1	0.06
∅ 3	38,400	2,736	4.5	0.15	34,560	2,462	4.5	0.15	27,648	1,149	1.5	0.09
∅ 4	28,800	3,168	6	0.2	25,920	2,851	6	0.2	20,736	1,331	2	0.12
∅ 5	24,000	3,600	7.5	0.25	21,600	3,240	7.5	0.25	17,280	1,512	2.5	0.15
∅ 6	19,200	4,176	9	0.3	17,280	3,758	9	0.3	13,824	1,754	3	0.18
∅ 8	14,400	4,176	12	0.4	12,960	3,758	12	0.4	10,368	1,754	4	0.24
∅ 10	11,520	4,176	15	0.5	10,368	3,758	15	0.5	8,294	1,754	5	0.3
∅ 12	9,600	3,456	18	0.6	8,640	3,110	18	0.6	6,912	1,452	6	0.36
∅ 16	7,200	2,592	24	0.8	6,480	2,333	24	0.8	5,184	1,089	8	0.48
∅ 20	5,760	2,088	30	1	5,184	1,879	30	1	4,147	877	10	0.6

절입량  
Depth of Cut

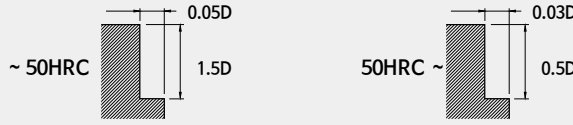

- 날 끝이 정밀하게 연삭되어 있습니다. 파손을 피하기 위해 가능하면 비접촉 방식으로 측정하십시오.
- HRC52 이상 고경도강 가공시 같은 직경의 같은 비율로 20% DOWN 시켜주세요.
- 유효장이 길게 체결시 회전수와 피드를 같은 비율로 DOWN 해주십시오.
- 상기 절삭조건은 참고 수치이므로 실 가공시 가공 형상, 가공 목적, 적용 기계에 따라 조건 변경 요망합니다.
- 조건표가 기계의 최대 스피드 속도를 초과하거나 버 및 적열현상이 발생할 때 스피드 속도와 이송속도를 비례하여 조정하십시오.
- 에어브로, 절삭유, 오일 미스트 콜러트를 추천하며, 칩을 잘 제거하고 가공시 발열과 발화에 주의 하십시오
- The edge of the flute precisely grinded. If you want to measure the tool, and to avoid damaging on the flutes, use non-contact measuring method.
- When milling workpiece HRC over 52 hardened steel, reduce 20% of the RPM and feed compared to the same diameter.
- If you clamp the endmill with long overhang of effective length, reduce the RPM and feed in the same proportion.
- Use this table for your reference. Adjust the parameters depending on your machining geometry, machining purpose and CNC.
- If the table over the maximum RPM and feed of your machine, or found red heat on the material, adjust RPM and feed in the same proportion.
- Air blow or mist coolants are recommended and note for chip emission, heat, or ignition.

피삭재 Material		동 합금 Copper alloys C1100				합금강 / 프리하드강 Alloy Steels / Prehardened Steels NAK80/KP4M				고경도강 Hardened Steels STAVAX/SKD11							
경도 Hardness		40 ~ 45Hrc												45 ~ 55Hrc			
외경 Outside Diameter	유효장 Effective Length	RPM	FEED	Ap Axial Depth	Ae Radial Depth	RPM	FEED	Ap Axial Depth	Ae Radial Depth	RPM	FEED	Ap Axial Depth	Ae Radial Depth				
∅ 0.2	1	50,000	352	0.016	0.020	50,000	264	0.006	0.020	34,500	211	0.004	0.020				
"	1.5	50,000	311	0.017	0.010	50,000	233	0.005	0.010	26,450	186	0.003	0.010				
∅ 0.3	1	50,000	890	0.029	0.020	50,000	668	0.007	0.020	34,500	534	0.005	0.015				
"	3	50,000	393	0.029	0.015	50,000	295	0.006	0.015	24,150	236	0.003	0.010				
∅ 0.4	1	47,150	890	0.047	0.062	50,000	668	0.013	0.070	39,675	534	0.011	0.070				
"	3	33,350	683	0.026	0.053	26,450	512	0.008	0.026	26,450	410	0.007	0.026				
∅ 0.5	1	48,300	2,008	0.079	0.114	48,300	668	0.033	0.119	39,100	534	0.029	0.119				
"	3	31,050	1,118	0.056	0.088	31,050	525	0.022	0.110	25,415	420	0.020	0.110				
"	5	25,760	827	0.026	0.044	25,760	510	0.011	0.010	20,700	408	0.010	0.010				
∅ 0.6	2	27,945	890	0.111	0.158	27,945	668	0.010	0.214	23,000	534	0.010	0.214				
"	6	16,445	435	0.035	0.044	16,445	326	0.003	0.010	13,570	261	0.003	0.010				
∅ 0.8	4	17,250	787	0.129	0.194	17,020	590	0.014	0.114	14,720	472	0.015	0.114				
"	8	12,650	475	0.029	0.098	12,650	264	0.005	0.088	10,695	184	0.004	0.088				
∅ 1	4	13,800	1,449	0.196	0.396	13,800	805	0.034	0.264	11,730	655	0.029	0.264				
"	10	8,625	559	0.047	0.308	8,625	311	0.013	0.123	7,475	264	0.011	0.123				
"	16	6,900	331	0.018	0.220	6,900	184	0.005	0.026	5,980	161	0.004	0.026				
∅ 1.2	6	9,200	1,035	0.182	0.457	9,200	575	0.021	0.088	8,165	483	0.018	0.088				
"	12	6,670	662	0.053	0.396	6,670	368	0.010	0.070	5,980	299	0.007	0.070				
∅ 1.5	4	12,880	1,925	0.293	0.660	12,880	1,070	0.059	0.440	11,730	920	0.044	0.440				
"	10	8,280	1,325	0.147	0.554	8,280	736	0.041	0.282	7,590	633	0.031	0.282				
"	20	5,865	725	0.041	0.352	6,350	403	0.006	0.106	4,160	345	0.005	0.106				
∅ 2	6	12,535	1,801	0.314	0.836	12,535	1,001	0.059	0.792	11,730	909	0.042	0.792				
"	12	9,200	1,449	0.182	0.704	9,200	805	0.043	0.440	8,280	725	0.030	0.440				
"	20	6,900	1,139	0.091	0.651	6,200	633	0.023	0.194	3,520	564	0.017	0.194				
"	30	5,865	973	0.049	0.440	3,300	541	0.005	0.132	2,860	495	0.005	0.132				
∅ 2.5	10	10,350	1,801	0.331	0.836	10,350	1,001	0.073	0.528	9,775	943	0.051	0.528				
"	30	6,210	787	0.067	0.616	6,210	437	0.016	0.176	5,865	414	0.011	0.176				
∅ 3	12	10,350	2,029	0.381	0.831	10,350	1,127	0.103	0.655	9,775	874	0.103	0.616				
"	20	8,165	1,553	0.254	0.762	6,050	863	0.071	0.567	3,420	667	0.071	0.567				
"	30	6,900	1,263	0.137	0.674	3,300	702	0.049	0.371	2,890	541	0.049	0.371				
∅ 4	12	8,740	1,904	0.401	1.525	8,740	1,058	0.117	1.124	7,360	920	0.081	1.124				
"	20	6,785	1,458	0.375	1.325	5,880	810	0.078	0.880	5,750	840	0.053	0.880				
"	30	5,750	752	0.196	1.210	2,950	418	0.041	0.671	2,540	656	0.028	0.671				
"	45	4,715	500	0.096	1.118	2,300	278	0.010	0.326	2,015	322	0.007	0.326				
∅ 5	15	7,705	3,064	0.697	2.277	7,705	1,702	0.150	1.346	5,520	1,139	0.106	1.346				
"	30	5,290	1,470	0.342	1.760	2,780	817	0.075	1.035	3,795	541	0.053	1.035				
∅ 6	20	5,980	2,194	0.600	2.194	5,460	1,219	0.476	1.356	3,565	1,035	0.186	1.356				
"	40	4,600	1,635	0.565	2.049	2,380	909	0.410	1.304	2,160	759	0.164	1.304				
∅ 8	22	5,520	1,946	0.528	2.542	5,520	1,081	0.419	1.518	3,220	909	0.164	1.518				
"	40	4,140	1,449	0.497	2.277	2,120	805	0.361	1.323	2,080	667	0.144	1.323				
∅ 10	24	4,600	1,656	0.449	2.887	4,485	920	0.356	1.645	2,760	771	0.139	1.645				
"	45	3,450	1,221	0.423	2.438	3,450	679	0.307	1.334	1,955	564	0.122	1.334				
∅ 12	26	3,795	1,387	0.377	3.013	3,795	771	0.299	2.024	2,300	644	0.117	2.024				
"	50	2,875	1,035	0.355	2.415	2,875	575	0.258	1.403	1,725	483	0.103	1.403				
∅ 16	35	2,990	1,097	0.302	2.921	2,990	610	0.239	2.162	1,725	518	0.094	2.162				



- HRC52 이상인 경우 같은 직경의 같은 비율로 20% DOWN 시켜 주십시오.
- 유효장이 긴 경우에는 회전수와 이송속도를 최대 30% 이하로 줄이십시오.
- Ae 값 설정시 코너R 치수를 고려해 주십시오.
- 곡면 절삭시 날경의 코너R 보다 낮은 이동 PITCH를 설정 하십시오.
- 곡면 절삭시 안정적인 속도 내에서 피드를 최대 30%까지 UP 해주십시오.

- When milling workpiece HRC over 52 hardened steel , reduce 20% of the RPM and feed compared to the same diameter.
- If the effective length is long, reduce the RPM and feed maximum 30%.
- Consider the corner radius value when you set up the Ae value.
- For curved milling, set up the lower value of the pitch than the corner radius value of tool diameter.
- For curved milling, raise up the feed up to 30% in stable milling condition.

피삭재 Material		공구강/금형강 Tool steels / Mold steels SCM/HPM				합금강/프리하든강 Alloy Steels / Pre-hardened Steels NAK80 / KP4M				고경도강 Hardened Steels STAVX / SKD11			
경도 Hardness		30 ~ 40HRC				40 ~ 45HRC				45 ~ 55HRC			
외경 Outside Diameter	유효장 Effective Length	RPM	FEED	Ap Axial Depth	Ae Radial Depth	RPM	FEED	Ap Axial Depth	Ae Radial Depth	RPM	FEED	Ap Axial Depth	Ae Radial Depth
∅ 1	4	13,110	1,884	0.216	0.435	13,110	700	0.038	0.290	13,000	650	0.032	0.290
"	10	8,194	727	0.052	0.339	8,194	404	0.014	0.135	7,101	343	0.012	0.135
∅ 1.2	4	12,500	1,346	0.200	0.503	8,740	950	0.024	0.097	12,500	750	0.019	0.097
"	10	8,000	861	0.058	0.435	6,337	650	0.009	0.077	5,681	389	0.008	0.077
∅ 1.5	6	12,236	2,503	0.323	0.726	12,236	1,390	0.065	0.484	11,144	900	0.048	0.484
"	12	7,866	1,722	0.161	0.610	7,866	957	0.045	0.310	7,211	822	0.034	0.310
∅ 2	6	11,908	2,341	0.345	0.919	11,908	1,301	0.065	0.871	11,144	1,181	0.046	0.871
"	12	8,740	1,884	0.200	0.774	8,740	1,047	0.047	0.484	7,866	942	0.033	0.484
∅ 2.5	10	9,833	2,341	0.365	0.919	9,833	1,301	0.081	0.581	9,286	1,226	0.056	0.581
"	20	5,900	1,023	0.074	0.677	5,900	568	0.017	0.194	5,572	538	0.012	0.194
∅ 3	10	9,833	2,637	0.419	0.914	9,833	1,465	0.113	0.720	9,286	1,136	0.113	0.678
"	20	7,757	2,018	0.280	0.839	5,748	1,121	0.078	0.624	3,249	867	0.078	0.624
∅ 4	12	8,303	2,476	0.441	1.677	8,303	1,375	0.129	1.237	6,992	1,196	0.089	1.237
"	20	6,446	1,895	0.413	1.457	5,586	1,053	0.086	0.968	5,463	1,091	0.058	0.968
"	30	5,463	978	0.215	1.331	2,803	543	0.046	0.738	2,413	852	0.031	0.738
∅ 6	20	5,681	2,852	0.660	2.414	5,187	1,585	0.524	1.491	3,387	1,346	0.205	1.491
"	40	4,370	2,126	0.622	2.254	2,261	1,181	0.451	1.435	2,052	987	0.180	1.435
∅ 8	22	5,244	2,530	0.581	2.796	5,244	1,405	0.461	1.670	3,059	1,181	0.180	1.670
∅ 10	24	4,370	2,153	0.494	3.175	4,261	1,196	0.392	1.809	2,622	1,002	0.153	1.809
∅ 12	26	3,605	1,803	0.415	3.314	3,605	1,002	0.329	2.226	2,185	837	0.129	2.226

**절입량**  
Depth of Cut

Slotting  
• Ap : Axial Depth  
• D : Outside Diameter

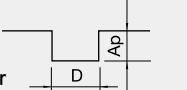

Side Milling

• Ap : Axial Depth  
• Ae : Radial Depth

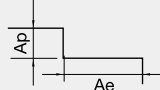

경사진면절삭  
Inclined Cutting



- HRC52 이상인 경우 같은 직경의 같은 비율로 20% DOWN 시켜 주십시오.
- 유효장이 긴 경우에는 회전수와 이송속도를 최대30% 이하로 줄이십시오.
- Ae 값 설정시 코너R 치수를 고려해 주십시오.
- 곡면 절삭시 날경의 코너R 보다 낮은 이동 PITCH를 설정 하십시오.
- 곡면 절삭시 안정적인 속도 내에서 피드를 최대 30%까지 UP 해주십시오.
- When milling workpiece HRC over 52 hardened steel , reduce 20% of the RPM and feed compared to the same diameter.
- If the effective length is long, reduce the RPM and feed maximum 30%.
- Consider the corner radius value when you set up the Ae value.
- For curved milling, set up the lower value of the pitch than the corner radius value of tool diameter.
- For curved milling, raise up the feed up to 30% in stable milling condition.

## 홈절삭 Slotting

피삭재 Material	공구강/ 금형강 Tool steels / Mold steels				프리하든강 Prehardened Steels				고경도강 Hardened Steels						
	경도 Hardness				30 ~ 40HRC				40 ~ 50HRC				45 ~ 55HRC		
외경 Outside Diameter	RPM	FEED	Ap	Ae	RPM	FEED	Ap	Ae	RPM	FEED	Ap	Ae			
			Axial Depth	Radial Depth			Axial Depth	Radial Depth			Axial Depth	Radial Depth			
ø 0.4	42,500	562	0.020	0.4	38,250	268	0.008	0.32	34,000	107	0.008	0.32			
ø 0.5	42,500	643	0.025	0.5	38,250	306	0.01	0.4	34,000	122	0.01	0.4			
ø 0.6	42,500	723	0.03	0.6	38,250	344	0.012	0.48	34,000	138	0.012	0.48			
ø 0.8	42,500	803	0.04	0.8	38,250	383	0.016	0.64	25,500	153	0.016	0.64			
ø 1	40,800	1,992	0.05	1	32,300	949	0.02	0.8	21,675	379	0.02	0.8			
ø 2	28,305	2,378	0.1	2	22,100	1,132	0.04	1.6	14,875	453	0.04	1.6			
ø 3	18,530	2,410	0.15	3	14,705	1,148	0.06	2.4	9,775	648	0.06	2.4			
ø 4	14,195	2,474	0.2	4	11,220	1,178	0.08	3.2	7,480	689	0.08	3.2			
ø 5	13,345	2,635	0.25	5	10,625	1,255	0.1	4	7,055	716	0.1	4			
ø 6	11,135	2,570	0.3	6	8,798	1,224	0.12	4.8	5,865	743	0.12	4.8			
ø 8	8,398	2,345	0.4	8	6,630	1,117	0.16	6.4	4,420	695	0.16	6.4			
ø 10	6,630	2,185	0.5	10	5,228	1,040	0.2	8	3,485	662	0.2	8			
ø 12	5,653	2,185	0.6	12	4,463	1,040	0.24	9.6	2,975	655	0.24	9.6			

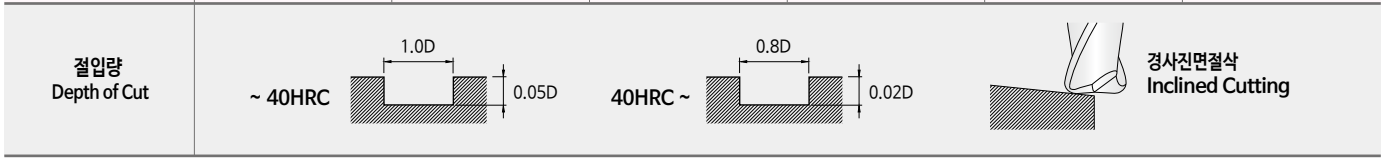

## 측면절삭 Side Cutting

피삭재 Material	공구강/ 금형강 Tool steels / Mold steels				프리하든강 Prehardened Steels				고경도강 Hardened Steels						
	경도 Hardness				30 ~ 40HRC				40 ~ 45HRC				45 ~ 55HRC		
외경 Outside Diameter	RPM	FEED	Ap	Ae	RPM	FEED	Ap	Ae	RPM	FEED	Ap	Ae			
			Axial Depth	Radial Depth			Axial Depth	Radial Depth			Axial Depth	Radial Depth			
ø 0.4	42,500	236	0.4	0.01	38,250	212	0.2	0.01	34,000	127	0.20	0.01			
ø 0.5	42,500	261	0.5	0.015	38,250	235	0.25	0.01	34,000	141	0.25	0.01			
ø 0.6	42,500	263	0.6	0.018	38,250	236	0.30	0.012	34,000	142	0.30	0.012			
ø 0.8	42,500	427	0.8	0.024	34,000	384	0.40	0.016	25,500	231	0.40	0.016			
ø 1	40,800	833	1	0.03	32,300	750	0.50	0.02	21,675	450	0.50	0.02			
ø 2	28,305	1,224	2	0.06	22,100	1,102	1.00	0.04	14,875	661	1.00	0.04			
ø 3	18,530	1,250	3	0.09	14,705	1,125	1.50	0.06	9,775	675	1.50	0.06			
ø 4	14,195	1,275	4	0.12	11,220	1,148	2.00	0.08	7,480	689	2.00	0.08			
ø 5	13,345	1,479	5	0.15	10,625	1,331	2.50	0.1	7,055	799	2.50	0.1			
ø 6	11,135	1,377	6	0.18	8,798	1,239	3.00	0.12	5,865	744	3.00	0.12			
ø 8	8,398	1,346	8	0.24	6,630	1,212	4.00	0.16	4,420	727	4.00	0.16			
ø 10	6,630	1,224	10	0.3	5,228	1,102	5.00	0.2	3,485	661	5.00	0.2			
ø 12	5,653	1,200	12	0.36	4,463	1,100	6.00	0.24	2,975	635	6.00	0.24			

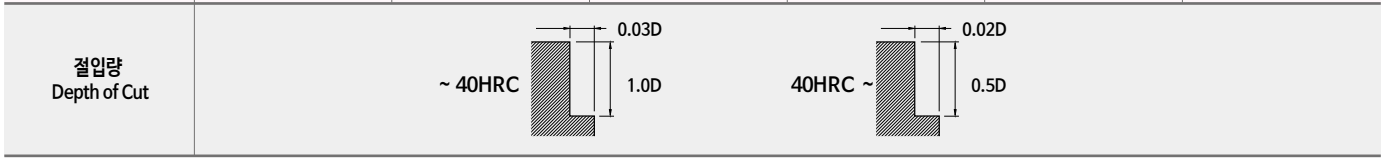

- HRC52 이상인 경우 같은 직경의 같은 비율로 20% DOWN 시켜 주십시오.
- 유효장이 긴 경우에는 회전수와 이송속도를 최대30% 이하로 줄이십시오.
- 곡면 절삭시 날경의 코너R 보다 낮은 이동 PITCH를 설정 하십시오.
- 곡면 절삭시 안정적인 속도 내에서 피드를 최대 30%까지 UP 해주십시오.
- 상기 절삭조건표는 2날 기준이며, 4날시 회전수는 유지하고, 피드는 안정적인 속도 내에서 최대 30%까지 UP 해주십시오.
- 홈 절삭시 날경의 코너R 대비 Ae 값을 설정 하십시오.
- 상기 절삭조건은 참고 수치이며 실 가공시 가공 형상, 가공 목적, 적용 기계에 따라 조건변경 요망 합니다.
- 피 삭재와 절삭 형상을 위한 적절한 쿨런트 사용과 가공시 발열, 발화에 주의 하십시오.

- When milling workpiece is over HRC 52 hardened steel, reduce 20% of the RPM and feed compared to the same diameter.
- If the effective length is long, reduce the RPM and feed maximum 30%.
- For curved milling, set up the lower value of the pitch than the corner radius value of tool diameter.
- For curved milling, raise up the feed up to 30% in stable milling condition.
- The parameters on the table is based on 2 flutes. For using 4 flutes, use the same RPM and raise up the feed up to 30% in stable milling condition.
- For groove milling, set up the Ae value by considering of corner radius value.
- Use this table for your reference. Adjust the parameters depending on your machining geometry, machining purpose and CNC.
- Use the adequate coolant for work material and machining geometry and note for heat and ignition.

홈절삭 Slotting																
피삭재 Material	일반구조강 / 쾌삭강 Mild steels / Free cutting steel HP / SM				구조용강 / 탄소강 / 회주철 Structural steel / Carbon Steels / Gray cast iron SS / SC / FC				공구강 / 금형강 Tool steels / Mold steels SCM / HPM				합금강 / 프리하든강 Alloy Steels / Pre-hardened Steels NAK80 / KP4M			
	경도 Hardness		~ 200HB		~ 30Hrc		~ 30Hrc		30 ~ 40Hrc		30 ~ 40Hrc		40 ~ 45Hrc			
외경 Outside Diameter	RPM	FEED	Ap	Ae	RPM	FEED	Ap	Ae	RPM	FEED	Ap	Ae	RPM	FEED	Ap	Ae
			Axial Depth	Radial Depth			Axial Depth	Radial Depth			Axial Depth	Radial Depth			Axial Depth	Radial Depth
ø 4	3,870	395	4	4	3,251	191	4	4	2,786	170	4	4	2,167	111	3.2	4
ø 5	3,870	395	5	5	3,251	218	5	5	2,477	195	5	5	1,858	127	4	5
ø 6	3,251	395	6	6	2,786	254	6	6	2,167	227	6	6	1,625	148	4.8	6
ø 8	2,477	395	8	8	2,090	305	8	8	1,625	273	8	8	1,238	177	6.4	8
ø 10	2,012	395	10	10	1,703	343	10	10	1,238	307	10	10	1,006	199	8	10
ø 12	1,625	395	12	12	1,393	300	12	12	1,084	268	12	12	851	174	9.6	12
ø 16	1,238	395	16	16	1,084	276	16	16	774	246	16	16	619	160	12.8	16
ø 20	1,006	372	20	20	851	254	20	20	619	227	20	20	495	148	16	20

절입량  
Depth of Cut

~ 38HRC

38HRC ~

측면절삭 Side Cutting																
피삭재 Material	일반구조강 / 쾌삭강 Mild steels / Free cutting steel HP / SM				구조용강 / 탄소강 / 회주철 Structural steel / Carbon Steels / Gray cast iron SS / SC / FC				공구강 / 금형강 Tool steels / Mold steels SCM / HPM				합금강 / 프리하든강 Alloy Steels / Pre-hardened Steels NAK80 / KP4M			
	경도 Hardness		~ 200HB		~ 30Hrc		~ 30Hrc		30 ~ 40Hrc		30 ~ 40Hrc		40 ~ 45Hrc			
외경 Outside Diameter	RPM	FEED	Ap	Ae	RPM	FEED	Ap	Ae	RPM	FEED	Ap	Ae	RPM	FEED	Ap	Ae
			Axial Depth	Radial Depth			Axial Depth	Radial Depth			Axial Depth	Radial Depth			Axial Depth	Radial Depth
ø 4	4,300	439	6	2	3,612	280	6	2	3,096	194	6	2	2,408	140	4	1.2
ø 5	4,300	439	7.5	2.5	3,612	290	7.5	2.5	2,752	215	7.5	2.5	2,064	161	5	1.5
ø 6	3,612	439	9	3	3,096	312	9	3	2,408	237	9	3	1,806	183	6	1.8
ø 8	2,752	439	12	4	2,322	355	12	4	1,806	269	12	4	1,376	204	8	2.4
ø 10	2,236	439	15	5	1,892	371	15	5	1,376	280	15	5	1,118	226	10	3
ø 12	1,806	439	18	6	1,548	387	18	6	1,204	290	18	6	946	231	12	3.6
ø 16	1,376	439	24	8	1,204	414	24	8	860	312	24	8	688	237	16	4.8
ø 20	1,118	413	30	10	946	403	30	10	688	301	30	10	550	226	20	6

절입량  
Depth of Cut

~ 38HRC

38HRC ~

- 가능한 공구 길이 측정시 유압식 측정이 아닌 레이저식 도구 세터를 사용 하십시오.
- 가공 진입시 가능한 피삭재 밖에서 진입 하십시오.
- 유효장이 긴 경우에는 회전수와 이송속도를 최대30% 이하로 줄이십시오.
- 상기 절삭조건은 참고 수치이므로 실 가공시 가공 형상, 가공 목적, 적용 기계에 따라 조건변경 요망 합니다.
- 동작기계와 가공물의 강성이 없는 경우, 진동이 발생할시 조건표에 회전속도와 이송속도를 같은 비율로 줄여서 적용 합니다.
- 피삭재와 가공 모양에 따라 적절한 콜러트를 사용 하십시오.
- 스테인레스, 내열합금강 등의 절단 가공시 수용성 절삭유가 가장 효과적 입니다.
- Use laser tool measurement instead of hydraulic measurement when measuring tool length as possible.
- When entering the tool to the workpiece, enter the tool from outside to the workpiece.
- If the effective length is long, reduce the RPM and feed maximum 30%.
- Use this table for your reference. Adjust the parameters depending on your machining geometry, machining purpose and CNC.
- In case of workpiece and machine do not have enough rigidity and make vibration, reduce the RPM and feed in same proportion.
- Depending on the workpiece and shape, use adequate coolant.
- For stainless and heat resistant alloy, water-soluble oil is the most effective.

## 홈절삭 Slotting

피삭재 Material	일반구조강 / 캐삭강 Mild steels / Free cutting steel HP / SM				구조용강 / 탄소강 / 회주철 Structural steel / Carbon Steels / Gray cast iron SS / SC / FC				공구강 / 금형강 Tool steels / Mold steels SCM / HPM				합금강 / 프리하든강 Alloy Steels / Pre-hardened Steels / Stainless Steels NAK80 / KP4M / SUS304 / SUS316			
	경도 Hardness ~ 200HB				~ 30HRC				30 ~ 40HRC				40 ~ 45HRC			
외경 Outside Diameter	RPM	FEED	Ap	Ae	RPM	FEED	Ap	Ae	RPM	FEED	Ap	Ae	RPM	FEED	Ap	Ae
			Axial Depth	Radial Depth			Axial Depth	Radial Depth			Axial Depth	Radial Depth			Axial Depth	Radial Depth
ø 4	4,698	486	4	4	3,888	243	4	4	3,321	162	4	4	2,592	122	3.2	4
ø 5	4,698	486	5	5	3,888	251	5	5	2,997	186	5	5	2,268	138	4	5
ø 6	3,888	486	6	6	3,402	267	6	6	2,592	203	6	6	1,944	162	4.8	6
ø 8	2,997	486	8	8	2,511	307	8	8	1,944	235	8	8	1,458	178	6.4	8
ø 10	2,430	486	10	10	2,025	324	10	10	1,458	243	10	10	1,215	203	8	10
ø 12	1,944	486	12	12	1,701	332	12	12	1,296	251	12	12	1,053	203	9.6	12
ø 16	1,499	486	16	16	1,296	356	16	16	972	267	16	16	810	203	12.8	16
ø 20	1,215	446	20	20	1,053	348	20	20	729	259	20	20	608	194	16	20

절입량  
Depth of Cut

~ 38HRC

38HRC ~

## 측면절삭 Side Cutting

피삭재 Material	일반구조강 / 캐삭강 Mild steels / Free cutting steel HP / SM				구조용강 / 탄소강 / 회주철 Structural steel / Carbon Steels / Gray cast iron SS / SC / FC				공구강 / 금형강 Tool steels / Mold steels SCM / HPM				합금강 / 프리하든강 Alloy Steels / Pre-hardened Steels / Stainless Steels NAK80 / KP4M / SUS304 / SUS316			
	경도 Hardness ~ 200HB				~ 30HRC				30 ~ 40HRC				40 ~ 45HRC			
외경 Outside Diameter	RPM	FEED	Ap	Ae	RPM	FEED	Ap	Ae	RPM	FEED	Ap	Ae	RPM	FEED	Ap	Ae
			Axial Depth	Radial Depth			Axial Depth	Radial Depth			Axial Depth	Radial Depth			Axial Depth	Radial Depth
ø 4	5,220	540	6	2	4,320	270	6	2	3,690	180	6	2	2,880	135	4	1.6
ø 5	5,220	540	7.5	2.5	4,320	279	7.5	2.5	3,330	207	7.5	2.5	2,520	153	5	2
ø 6	4,320	540	9	3	3,780	297	9	3	2,880	225	9	3	2,160	180	6	2.4
ø 8	3,330	540	12	4	2,790	342	12	4	2,160	261	12	4	1,620	198	8	3.2
ø 10	2,700	540	15	5	2,250	360	15	5	1,620	270	15	5	1,350	225	10	4
ø 12	2,160	540	18	6	1,890	369	18	6	1,440	279	18	6	1,170	225	12	4.8
ø 16	1,665	540	24	8	1,440	396	24	8	1,080	297	24	8	900	225	16	6.4
ø 20	1,350	495	30	10	1,170	387	30	10	810	288	30	10	675	216	20	8

절입량  
Depth of Cut

~ 38HRC

38HRC ~

- 가능한 공구 길이 측정시 유압식 측정이 아닌 레이저식 도구 세터를 사용 하십시오.
- 가공 진입시 가능한 피삭재 밖에서 진입 하십시오.
- 유효장이가 긴 경우에는 회전수와 이송속도를 최대30% 이하로 줄이십시오.
- 상기 절삭조건은 참고 수치이므로 실 가공시 가공 형상, 가공 목적, 적용 기계에 따라 조건변경 요망 합니다.
- 공작기계와 가공물의 강성이 없는 경우, 진동이 발생할시 조건표에 회전속도와 이송속도를 같은 비율로 줄여서 적용 합니다.
- 피삭재와 가공 모양에 따라 적절한 콜러트를 사용 하십시오.
- 스테인레스, 내열합금강 등의 절단 가공시 수용성 절삭유가 가장 효과적 입니다.
- Use laser tool measurement instead of hydraulic measurement when measuring tool length as possible.
- When entering the tool to the workpiece, enter the tool from outside to the workpiece.
- If the effective length is long, reduce the RPM and feed maximum 30%.
- Use this table for your reference. Adjust the parameters depending on your machining geometry, machining purpose and CNC.
- In case of workpiece and machine do not have enough rigidity and make vibration, reduce the RPM and feed in same proportion.
- Depending on the workpiece and shape, use adequate coolant.
- For stainless and heat resistant alloy, water-soluble oil is the most effective.



# 4VSB Cutting Condition

• RPM : rev./min • Feed : mm/min

피삭재 Material	구조용강 / 탄소강 / 회주철 Structural steel / Carbon Steels / Gray cast iron SS/SC/FC				공구강 / 금형강 Tool steels / Mold steels SCM/HPM				티타늄 합금강 Titanium alloy steels Ti6A				내열합금강 Heat Resistance Alloy				스테인레스강 Stainless Steels SUS304 / SUS316			
	~30HRc				30 ~ 40HRc				-				-				-			
반경 (Radius)	RPM	FEED	Ap Axial	Ae Radial	RPM	FEED	Ap Axial	Ae Radial	RPM	FEED	Ap Axial	Ae Radial	RPM	FEED	Ap Axial	Ae Radial	RPM	FEED	Ap Axial	Ae Radial
0.5R	44,500	1,000	1.00	0.50	37,825	750	1.00	0.50	16,000	600	0.30	0.50	9,550	110	0.30	0.20	25,500	1,000	1.00	0.50
0.6R	37,150	1,250	1.20	0.60	31,578	938	1.20	0.60	13,200	600	0.36	0.60	8,000	100	0.36	0.24	21,000	850	1.20	0.60
0.75R	29,720	1,300	1.50	0.75	25,262	975	1.50	0.75	10,600	600	0.45	0.75	6,300	80	0.45	0.30	17,000	700	1.50	0.75
1R	22,300	1,540	2.00	1.00	18,955	1,155	2.00	1.00	8,000	480	0.60	1.00	3,180	120	0.60	0.40	12,800	760	2.00	1.00
1.25R	17,800	1,650	2.50	1.25	15,130	1,238	2.50	1.25	6,400	380	0.75	1.25	2,500	100	0.75	0.50	10,000	600	2.50	1.25
1.5R	14,860	1,740	3.00	1.00	12,631	1,305	3.00	1.50	5,300	420	0.90	1.50	2,120	90	0.90	0.60	8,500	780	3.00	1.50
2R	11,150	1,624	4.00	2.00	9,478	1,218	4.00	2.00	4,000	300	1.20	2.00	1,590	100	1.20	0.80	6,370	640	4.00	2.00
2.5R	8,910	1,552	5.00	2.50	7,574	1,164	5.00	2.50	3,200	300	1.50	2.50	1,270	90	1.50	1.00	5,100	710	5.00	2.50
3R	7,430	1,450	6.00	3.00	6,316	1,088	6.00	3.00	2,650	300	1.80	3.00	1,000	85	1.80	1.20	4,250	680	6.00	3.00
4R	5,500	1,305	8.00	4.00	4,675	979	8.00	4.00	2,000	240	2.40	4.00	800	70	2.40	1.60	3,190	580	8.00	4.00
5R	4,460	1,160	10.00	5.00	3,791	870	10.00	5.00	1,600	230	3.00	5.00	630	60	3.00	2.00	2,550	500	10.00	5.00
6R	3,710	1,088	12.00	6.00	3,154	816	12.00	6.00	1,320	240	3.60	6.00	530	55	3.60	2.40	2,120	470	12.00	6.00
8R	2,790	885	16.00	8.00	2,372	663	16.00	8.00	1,000	200	4.80	8.00	400	45	4.80	3.20	1,600	390	16.00	8.00
10R	2,230	725	20.00	10.00	1,896	544	20.00	10.00	800	170	6.00	10.00	300	40	6.00	4.00	1,280	320	20.00	10.00
12.5R	1,780	624	25.00	12.50	1,513	468	25.00	12.50	630	150	7.50	12.50	255	35	7.50	5.00	1,000	260	25.00	12.50

<b>절입 기준</b> Depth of Cut		Ap : Axial Depth 축 방향의 절입 깊이(mm) Ae : Radial Depth 반경 방향의 절입 깊이(mm) D : Outside Diameter 외경(mm) n : Speed 회전 속도 (min <sup>-1</sup> ) Vf : Feed 이송 속도 (mm/min)
------------------------------	--	---

- 가공 진입시 가능 한 피삭재 밖에서 진입 하십시오.
- 절삭 조건이 없는 직경 및 유효장은 비슷한 직경 및 유효장에 비례하여 UP&DOWN 하여 설정 하십시오
- 상기 절삭조건은 참고 수치이므로 실 가공시 가공 형상, 가공 목적, 적용 기계에 따라 조건 변경 요망 합니다.
- 적용 기계의 회전속도가 부족한 경우에는 회전 속도와 이송속도를 같은 비율로 줄여서 적용합니다.
- 진동이 적고 강성이 좋은 공작기계 사용 요망합니다 ( Ø 1 이하 사용시 진동 허용 관리 5µm이내일것)
- 원활한 칩배출을 위하여 에어브로 혹은 미스트 쿨런트 사용을 추천합니다.
- When entering the tool to the workpiece, enter the tool from outside to the workpiece.
- If the diameter or effective length of your tool are not on the table, adjust it compared similarity value on the table.
- Use this table for your reference. Adjust the parameters depending on your machining geometry, machining purpose and CNC.
- If the table over the maximum RPM and feed of your machine, or found red heat on the material, adjust RPM and feed in the same proportion.
- Use a machine with low vibration and good rigidity(1 or less, the vibration tolerance management should be within 5µm)
- Air blow or mist coolants are recommended and note for chip emission, heat, or ignition.

# 4VSE/4VCC/4VSC Cutting Condition

• RPM : rev./min • Feed : mm/min

파삭재 Material	구조용강 / 탄소강 / 회주철 Structural steels / Carbon Steels / Gray cast irons SS/SC/FC				공구강 / 금형강 Tool steels / Mold steels SCM/HPM				티타늄 합금강 Titanium alloy steels Ti6A				내열 합금강 Heat Resistance Alloys				스테인리스강 Stainless Steels SUS304 / SUS316			
	~30Hrc				30 ~ 40Hrc				-				-				-			
외경 mm Outside Diameter	RPM	FEED	Ap Axial	Ae Radial	RPM	FEED	Ap Axial	Ae Radial	RPM	FEED	Ap Axial	Ae Radial	RPM	FEED	Ap Axial	Ae Radial	RPM	FEED	Ap Axial	Ae Radial
Ø1	41,400	800	1.50	0.50	38,000	690	1.50	0.50	22,920	150	1.00	0.30	10,800	100	1.00	0.20	31,900	380	1.50	0.35
Ø1.2	34,500	700	3.00	0.60	32,000	600	1.80	0.60	19,104	120	1.20	0.36	8,951	80	1.20	0.24	26,500	300	1.80	0.42
Ø1.5	27,600	550	2.25	0.75	25,600	450	2.25	0.75	15,360	100	1.50	0.45	7,155	65	1.50	0.30	21,200	250	2.25	0.53
Ø2	20,700	400	3.00	1.00	19,100	330	3.00	1.00	11,460	80	2.00	0.60	5,400	65	2.00	0.40	15,600	200	3.00	0.70
Ø2.5	16,500	330	3.75	1.25	15,300	270	3.75	1.25	9,120	70	2.50	0.75	4,293	50	2.50	0.50	12,800	150	3.75	0.88
Ø3	13,800	330	4.50	1.50	12,740	240	4.50	1.50	7,644	100	3.00	0.90	3,578	50	3.00	0.60	10,600	210	4.50	1.05
Ø4	10,350	410	6.00	2.00	9,560	405	6.00	2.00	5,736	160	4.00	1.20	2,700	40	4.00	0.80	8,000	150	6.00	1.40
Ø5	8,280	430	7.50	2.50	7,600	450	7.50	2.50	4,584	230	5.00	1.50	2,160	60	5.00	1.00	6,380	250	7.50	1.75
Ø6	6,900	550	9.00	3.00	6,400	450	9.00	3.00	3,840	250	6.00	1.80	1,782	116	6.00	1.20	5,300	420	9.00	2.10
Ø8	5,180	600	12.00	4.00	4,780	420	12.00	4.00	2,868	320	8.00	2.40	1,350	116	8.00	1.60	4,000	180	12.00	2.80
Ø10	4,140	780	15.00	5.00	4,140	600	15.00	5.00	2,400	380	10.00	3.00	1,080	131	10.00	2.00	3,180	510	15.00	3.50
Ø12	3,450	800	18.00	6.00	3,440	600	18.00	6.00	1,920	400	12.00	3.60	891	145	12.00	2.40	2,650	530	18.00	4.20
Ø16	2,600	700	24.00	8.00	2,600	600	24.00	8.00	1,440	350	16.00	4.80	675	131	16.00	3.20	2,000	400	24.00	5.60
Ø20	2,000	700	30.00	10.00	2,000	540	30.00	10.00	1,200	320	20.00	6.00	540	116	20.00	4.00	1,600	320	30.00	7.00



- 가공 진입시 가능 한 파삭재 밖에서 진입 하십시오.
- 절삭 조건이 없는 직경 및 유효장은 비슷한 직경 및 유효장에 비례하여 UP & DOWN 하여 설정 하십시오
- 날 끝이 정밀하게 연삭되어 있습니다. 파손을 피하기 위해 가능하면 비접촉 방식으로 측정하십시오.
- 상기 절삭조건은 참고 수치이므로 실 가공시 가공 형상, 가공 목적, 적용 기계에 따라 조건 변경 요망 합니다.
- 조건표가 기계의 최대 스피indle 속도를 초과하거나 버 및 적열 현상이 발생할 때 스피indle 속도와 이송 속도를 비례하여 조정하십시오.
- 진동이 적고 강성이 좋은 공작기계 사용 요망합니다 (Ø 1 이하 사용시 진동 허용 관리 5µm 이내일것)
- 에어브로, 절삭유, 오일 미스트 콜러트를 추천하며, 칩을 잘 제거하고 가공시 발열과 발화에 주의하십시오.
- When entering the tool to the workpiece, enter the tool from outside to the workpiece.
- If the diameter or effective length of your tool are not on the table, adjust it compared similarity value on the table.
- The edge the flute precisely grinded. If you want to measure the tool, and to avoid damaging on the flutes, use non-contact measuring method.
- Use this table for your reference. Adjust the parameters depending on your machining geometry, machining purpose and CNC.
- If the table over the maximum RPM and feed of your machine, or found red heat on the material, adjust RPM and feed in the same proportion.
- Use a machine with low vibration and good rigidity(1 or less, the vibration tolerance management should be within 5µm)
- Air blow or mist coolants are recommended and note for chip emission, heat, or ignition.

# 6VSE/6VSC Cutting Condition

• RPM : rev./min • Feed : mm/min

파삭재 Material	구조용강 / 탄소강 / 회주철 Structural steels / Carbon Steels / Gray cast irons SS/SC/FC				공구강 / 금형강 Tool steels / Mold steels SCM/HPM				티타늄 합금강 Titanium alloy steels Ti6A				내열 합금강 Heat Resistance Alloys				스테인리스강 Stainless Steels SUS304 / SUS316			
	~30Hrc				30 ~ 40Hrc				-				-				-			
외경 mm Outside Diameter	RPM	FEED	Ap Axial	AE Radial	RPM	FEED	Ap Axial	AE Radial	RPM	FEED	Ap Axial	AE Radial	RPM	FEED	Ap Axial	AE Radial	RPM	FEED	Ap Axial	AE Radial
Ø3	21,000	5,200	6.0	0.20	18,500	2,000	6.0	0.20	7,400	900	4.5	0.2	2,860	280	4.5	0.2	5,600	1,350	6.0	0.20
Ø4	18,000	5,750	8.0	0.20	16,000	2,410	8.0	0.20	6,850	930	6.0	0.2	2,100	300	6.0	0.2	5,950	1,650	8.0	0.20
Ø5	15,200	6,100	10.0	0.30	13,500	2,850	10.0	0.30	6,100	1,050	7.5	0.3	1,850	360	7.5	0.3	6,300	1,800	10.0	0.30
Ø6	14,500	6,300	12.0	0.30	12,000	3,100	12.0	0.30	5,800	1,150	9.0	0.3	1,700	385	9.0	0.3	6,800	2,000	12.0	0.30
Ø8	12,000	8,150	14.0	0.40	8,500	3,900	14.0	0.40	4,350	1,350	10.5	0.4	1,450	420	10.5	0.4	5,400	2,300	14.0	0.40
Ø10	9,500	7,950	20.0	0.50	7,250	4,100	20.0	0.50	3,400	1,500	15.0	0.5	1,000	460	15.0	0.5	4,850	2,400	20.0	0.50
Ø12	8,200	7,800	24.0	0.60	5,900	4,250	24.0	0.60	2,850	1,650	18.0	0.6	900	490	18.0	0.6	3,900	2,600	24.0	0.60
Ø16	6,200	6,800	32.0	0.80	4,250	3,950	32.0	0.80	2,450	1,350	24.0	0.8	750	400	24.0	0.8	2,800	2,000	32.0	0.80
Ø20	4,850	6,650	40.0	1.00	3,650	3,650	40.0	1.00	1,950	1,200	30.0	1.0	580	360	30.0	1.0	2,650	1,700	40.0	1.00

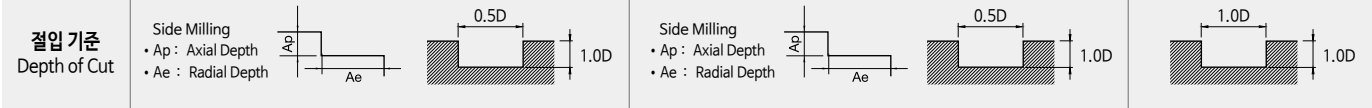

- 가공 진입시 가능 한 파삭재 밖에서 진입 하십시오.
- 절삭 조건이 없는 직경 및 유효장은 비슷한 직경 및 유효장에 비례하여 UP & DOWN 하여 설정 하십시오
- 날 끝이 정밀하게 연삭되어 있습니다. 파손을 피하기 위해 가능하면 비접촉 방식으로 측정하십시오.
- 상기 절삭조건은 참고 수치이므로 실 가공시 가공 형상, 가공 목적, 적용 기계에 따라 조건 변경 요망 합니다.
- 조건표가 기계의 최대 스피indle 속도를 초과하거나 버 및 적열 현상이 발생할 때 스피indle 속도와 이송 속도를 비례하여 조정하십시오.
- 진동이 적고 강성이 좋은 공작기계 사용 요망합니다 (Ø 1 이하 사용시 진동 허용 관리 5µm 이내일것)
- 에어브로, 절삭유, 오일 미스트 콜러트를 추천하며, 칩을 잘 제거하고 가공시 발열과 발화에 주의하십시오.
- When entering the tool to the workpiece, enter the tool from outside to the workpiece.
- If the diameter or effective length of your tool are not on the table, adjust it compared similarity value on the table.
- The edge the flute precisely grinded. If you want to measure the tool, and to avoid damaging on the flutes, use non-contact measuring method.
- Use this table for your reference. Adjust the parameters depending on your machining geometry, machining purpose and CNC.
- If the table over the maximum RPM and feed of your machine, or found red heat on the material, adjust RPM and feed in the same proportion.
- Use a machine with low vibration and good rigidity(1 or less, the vibration tolerance management should be within 5µm)
- Air blow or mist coolants are recommended and note for chip emission, heat, or ignition.

# SVCC Cutting Condition

• RPM : rev./min • Feed : mm/min

피삭재 Material	구조용강 / 탄소강 / 회주철 Structural steels / Carbon Steels / Gray cast irons SS / SC / FC				공구강 / 금형강 Tool steels / Mold steels SCM / HPM				티타늄 합금강 Titanium alloy steels Ti6A				내열합금강 Heat Resistance Alloys				스테인레스강 Stainless Steels SUS304 / SUS316			
	~30HRc				30 ~ 40HRc				-				-				-			
외경 mm Outside Diameter	RPM	FEED	Ap Axial Depth	AE Radial Depth	RPM	FEED	Ap Axial Depth	AE Radial Depth	RPM	FEED	Ap Axial Depth	AE Radial Depth	RPM	FEED	Ap Axial Depth	AE Radial Depth	RPM	FEED	Ap Axial Depth	AE Radial Depth
Ø6	12,000	3,025	9.0	0.3	8,000	2,020	9.0	3.0	5,180	525	6.00	1.80	1,890	186	6.00	1.20	5,930	1,600	9.0	2.10
Ø8	9,000	3,300	12.0	0.4	5,900	2,300	12.0	4.0	3,800	670	8.00	2.40	1,430	186	8.00	1.60	4,480	1,820	12.0	2.80
Ø10	7,200	4,290	15.0	0.5	5,100	2,700	15.0	5.0	3,240	800	10.00	3.00	1,145	209	10.00	2.00	3,560	1,940	15.0	3.50
Ø12	6,000	4,400	18.0	0.6	4,300	2,700	18.0	6.0	2,590	840	12.00	3.60	945	230	12.00	2.40	2,970	2,000	18.0	4.20
Ø14	8,300	4,150	21.0	0.7	3,840	2,700	21.0	7.0	2,300	790	14.00	4.20	820	220	14.00	2.80	2,540	1,780	21.0	4.90
Ø16	4,500	3,850	24.0	0.8	3,250	2,700	24.0	8.0	1,900	735	16.00	4.80	715	210	16.00	3.20	2,240	1,520	24.0	5.60
Ø18	3,950	3,850	27.0	0.9	2,860	2,560	27.0	9.0	1,750	700	18.00	5.40	630	195	18.00	3.60	2,010	1,350	27.0	6.30
Ø20	3,480	3,850	30.0	1.0	2,500	2,430	30.0	10.0	1,620	670	20.00	6.00	570	185	20.00	4.00	1,800	1,220	30.0	7.00

절입 기준  
Depth of Cut

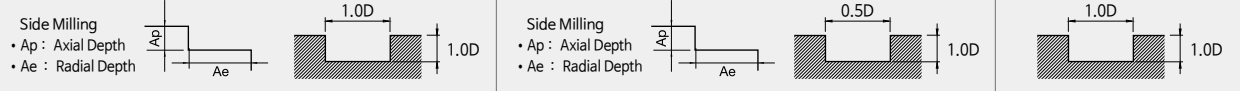

- 가공 진입시 가능한 피삭재 밖에서 진입 하십시오.
- 절삭 조건이 없는 직경 및 유효장은 비슷한 직경 및 유효장에 비례하여 UP & DOWN 하여 설정 하십시오
- 날 경의 코너C 대비 Ae 값을 설정 하십시오.
- 상기 절삭조건은 참고 수치이므로 실 가공시 가공 형상, 가공 목적, 적용 기계에 따라 조건 변경 요망 합니다.
- 조건표가 기계의 최대 스피들 속도를 초과하거나 버 및 적열 현상이 발생할 때 스피들 속도와 이송 속도를 비례하여 조정하십시오.
- 진동이 적고 강성이 좋은 공작기계 사용 요망합니다 (Ø 1 이하 사용자 진동 허용 관리 5µm 이내일것)
- 에어브로, 절삭유, 오일 미스트 콜러트를 추천하며, 칩을 잘 제거하고 가공 시의 발열과 발화에 주의하십시오.
- When entering the tool to the workpiece, enter the tool from outside to the workpiece.
- If the diameter or effective length of your tool are not on the table, adjust it compared similarity value on the table.
- Set ae figure considering Corner C figure of diameter.
- Use this table for your reference. Adjust the parameters depending on your machining geometry, machining purpose and CNC.
- If the table over the maximum RPM and feed of your machine, or found red heat on the material, adjust RPM and feed in the same proportion.
- Use a machine with low vibration and good rigidity (1 or less, the vibration tolerance management should be within 5µm)
- Air blow or mist coolants are recommended and note for chip emission, heat, or ignition.

# 4SLE Cutting Condition

• RPM : rev./min • Feed : mm/min

피삭재 Material	합금강 / 프리하든강 Alloy Steels / Pre-hardened Steels NAK80 / KP4M 40~45HRC				스테인레스강 / 티타늄 합금강 Stainless Steels / Titanium alloy steels SUS304 / SUS316 / Ti6A				내열합금강 Heat Resistance Alloys			
	40 ~ 45HRc				-				-			
외경 Outside Diameter	RPM	FEED	Ap Axial Depth	Ae Radial Depth	RPM	FEED	Ap Axial Depth	Ae Radial Depth	RPM	FEED	Ap Axial Depth	Ae Radial Depth
Ø 3	13,270	740	2.4	3.0	5,840	260	2.4	3.0	3,185	115	2.4	3.0
Ø 4	9,950	710	3.2	4.0	4,380	245	3.2	4.0	2,390	115	3.2	4.0
Ø 6	6,630	720	4.8	6.0	2,920	245	4.8	6.0	1,590	115	4.8	6.0
Ø 8	4,970	800	6.4	8.0	2,190	245	6.4	8.0	1,190	115	6.4	8.0
Ø 10	3,980	800	8.0	10.0	1,750	245	8.0	10.0	955	115	8.0	10.0
Ø 12	3,320	800	9.6	12.0	1,460	245	9.6	12.0	796	115	9.6	12.0
Ø 16	2,490	800	12.8	16.0	1,095	245	12.8	16.0	597	115	12.8	16.0
Ø 20	1,990	800	16.0	20.0	880	245	16.0	20.0	480	115	16.0	20.0

절입량  
Depth of Cut

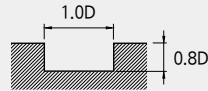

- 유효장 길이가 긴 경우, RPM과 FEED를 동일 비율로 낮춰주세요.
- 가공 진입시 가능한 피삭재 밖에서 진입 하십시오.
- 절삭 조건이 없는 직경 및 유효장은 비슷한 직경 및 유효장에 비례하여 UP & DOWN 하여 설정 하십시오.
- 날 끝이 정밀하게 연삭되어 있습니다. 파손을 피하기 위해 가능한 비접촉 방식으로 측정 하십시오.
- 상기 절삭조건은 참고 수치이므로 실 가공시 가공 형상, 가공 목적, 적용 기계에 따라 조건변경 요망 합니다.
- 조건표가 기계의 최대 스피들 속도를 초과하거나 버 및 적열 현상이 발생할 때 스피들 속도와 이송 속도를 비례하여 조정 하십시오.
- 에어브로, 절삭유, 오일 미스트 콜러트를 추천하며, 칩을 잘 제거하고 가공시 발열과 발화에 주의 하십시오
- If the effective length is long, reduce the RPM and feed in the same proportion.
- When entering the tool to the workpiece, enter the tool from outside to the workpiece.
- If the diameter or effective length of your tool are not on the table, adjust it compared similarity value on the table.
- The edge of the flute precisely grinded. If you want to measure the tool, and to avoid damaging on the flutes, use non-contact measuring method.
- Use this table for your reference. Adjust the parameters depending on your machining geometry, machining purpose and CNC.
- If the table over the maximum RPM and feed of your machine, or found red heat on the material, adjust RPM and feed in the same proportion.
- Air blow or mist coolants are recommended and note for chip emission, heat, or ignition.

# 7SUC Cutting Condition

• RPM : rev./min • Feed : mm/min

피삭재 Material	합금강 / 프리하든강 Alloy Steels / Pre-hardened Steels NAK80 / KP4M 40~45HRC				스테인레스강 / 티타늄 합금강 Stainless Steels / Titanium alloy steels SUS304 / SUS316 / Ti6A				내열합금강 Heat Resistance Alloys			
	40 ~ 45HRC				-				-			
외경 Outside Diameter	RPM	FEED	Ap Axial Depth	Ae Radial Depth	RPM	FEED	Ap Axial Depth	Ae Radial Depth	RPM	FEED	Ap Axial Depth	Ae Radial Depth
ø 6	4,070	925	6	6	4,070	550	3	6	1,430	200	1.2	6
ø 8	3,080	838	8	8	3,080	488	4	8	1,100	163	1.6	8
ø 10	2,420	663	10	10	2,420	438	5	10	880	163	2	10
ø 12	2,090	663	12	12	2,090	375	6	12	726	138	2.4	12
ø 16	1,540	488	16	16	1,540	350	8	16	550	100	3.2	16
ø 20	1,210	438	20	20	1,210	325	10	20	440	75	4	20
절입량 Depth of Cut												

- 유효장 길이가 긴 경우, RPM과 FEED를 동일 비율로 낮춰주세요.
- 가공 진입시 가능한 피삭재 밖에서 진입 하십시오.
- 절삭 조건이 없는 직경 및 유효장은 비슷한 직경 및 유효장에 비례하여 UP&DOWN 하여 설정 하십시오.
- 상기 절삭조건은 참고 수치이므로 실 가공시 가공 형상, 가공 목적, 적용 기계에 따라 조건변경 요망 합니다.
- 조건표가 기계의 최대 스피들 속도를 초과하거나 버 및 적열 현상이 발생할 때 스피들 속도와 이송속도를 비례하여 조정 하십시오.
- 에어브로, 절삭유, 오일 미스트 콜러트를 추천하며, 칩을 잘 제거하고 가공시 발열과 발화에 주의 하십시오
- If the effective length is long, reduce the RPM and feed in the same proportion.
- When entering the tool to the workpiece, enter the tool from outside to the workpiece.
- If the diameter or effective length of your tool are not on the table, adjust it compared similarity value on the table.
- Use this table for your reference. Adjust the parameters depending on your machining geometry, machining purpose and CNC.
- If the table over the maximum RPM and feed of your machine, or found red heat on the material, adjust RPM and feed in the same proportion.
- Air blow or mist coolants are recommended and note for chip emission, heat, or ignition.

# 5&6TROE Cutting Condition

• RPM : rev./min • Feed : mm/min

피삭재 Material	합금강 / 프리하든강 Alloy Steels / Pre-hardened Steels NAK80 / KP4M				스테인레스강 / 티타늄 합금강 Stainless Steels / Titanium alloy steels SUS304 / SUS316 / Ti6A				내열합금강 Heat Resistance Alloys			
	40 ~ 45HRC				-				-			
외경 Outside Diameter	RPM	FEED	Ap Axial Depth	Ae Radial Depth	RPM	FEED	Ap Axial Depth	Ae Radial Depth	RPM	FEED	Ap Axial Depth	Ae Radial Depth
ø 6	3,700	450	6	0.3	3,200	380	6	0.3	1,100	65	6	0.3
ø 8	2,800	400	8	0.4	2,350	420	8	0.4	950	60	8	0.4
ø 10	2,250	325	10	0.5	1,990	350	10	0.5	750	60	10	0.5
ø 12	1,990	300	12	0.6	1,550	270	12	0.6	600	55	12	0.6
ø 16	1,550	250	16	0.8	1,250	250	16	0.8	500	50	16	0.8
ø 20	1,200	180	20	1	900	150	20	1	350	50	20	1
절입량 Depth of Cut												

- 유효장 길이가 긴 경우, RPM과 FEED를 동일 비율로 낮춰주세요.
- 가공 진입시 가능한 피삭재 밖에서 진입 하십시오.
- 절삭 조건이 없는 직경 및 유효장은 비슷한 직경 및 유효장에 비례하여 UP&DOWN 하여 설정 하십시오.
- 상기 절삭조건은 참고 수치이므로 실 가공시 가공 형상, 가공 목적, 적용 기계에 따라 조건변경 요망 합니다.
- 조건표가 기계의 최대 스피들 속도를 초과하거나 버 및 적열 현상이 발생할 때 스피들 속도와 이송 속도를 비례하여 조정 하십시오.
- 에어브로, 절삭유, 오일 미스트 콜러트를 추천하며, 칩을 잘 제거하고 가공시 발열과 발화에 주의 하십시오
- If the effective length is long, reduce the RPM and feed in the same proportion.
- When entering the tool to the workpiece, enter the tool from outside to the workpiece.
- If the diameter or effective length of your tool are not on the table, adjust it compared similarity value on the table.
- Use this table for your reference. Adjust the parameters depending on your machining geometry, machining purpose and CNC.
- If the table over the maximum RPM and feed of your machine, or found red heat on the material, adjust RPM and feed in the same proportion.
- Air blow or mist coolants are recommended and note for chip emission, heat, or ignition.

피삭재 Material		흑연 Graphite			
반경 Radius	유효장 Effective Length	RPM	FEED	Ap Axial Depth	Ae Radial Depth
R 0.25	5	25,000	320	0.10	0.10
R 0.5	10	21,850	380	0.20	0.20
"	20	19,665	342	0.18	0.18
"	30	18,682	325	0.15	0.15
R 0.75	10	21,850	646	0.30	0.30
"	20	19,665	630	0.27	0.27
"	30	18,682	580	0.23	0.23
R 1	15	19,950	760	0.40	0.40
"	20	17,955	684	0.36	0.36
"	30	16,160	616	0.32	0.32
"	40	13,736	523	0.26	0.26
"	50	10,988	419	0.21	0.21
R 1.5	20	17,575	1,378	0.60	0.60
"	30	15,818	1,240	0.54	0.54
"	40	14,236	1,116	0.49	0.49
"	50	12,100	948	0.44	0.44
R 2	20	15,200	1,995	0.80	0.80
"	35	13,680	1,796	0.72	0.72
"	45	12,312	1,616	0.61	0.61
R 2.5	25	14,725	2,423	1.00	1.00
"	50	11,780	1,938	0.80	0.80
R 3	25	14,250	2,803	1.20	1.20
R 4	30	12,350	2,850	1.60	1.60
R 5	-	10,925	2,898	2.00	2.00
R 6	-	9,975	2,993	2.40	2.40
R 8	-	7,600	2,375	3.20	3.20
R 10	-	6,175	1,900	4.00	4.00

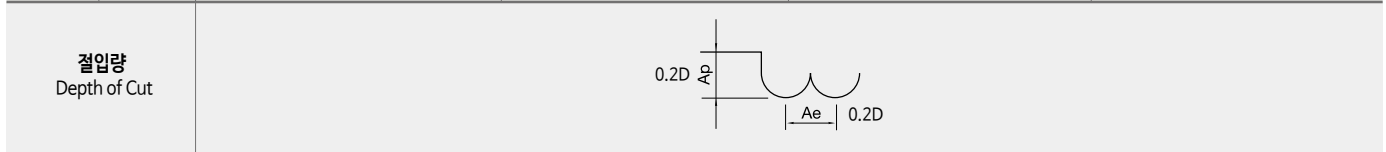

- 유효장이 긴 경우에는 회전수와 이송속도를 최대20% 이하로 줄이십시오.
- 절삭 조건표에 없는 유효장은 같은 직경과 비례하여 DOWN 시켜주십시오.
- 상기 절삭조건은 참고 수치이므로 실 가공시 가공 형상, 가공 목적, 적용 기계에 따라 조건변경 요망 합니다.
- 공작기계와 가공물의 강성이 없는 경우, 진동이 발생할시 조건표에 회전속도와 이송속도를 같은 비율로 줄여서 적용 합니다.
- In case of long effective length, reduce the RPM and feed by 20% or less.
- If the effective length of your tool does not show above the table, use the shorten effevtive length of parameter and reduce the parameters in the same proportion.
- Use this table for your reference. Adjust the parameters depending on your machining geometry, machining purpose and CNC.
- In case of workpiece and machine do not have enough rigidity and make vibration, reduce the RPM and feed in same proportion.

피삭재 Material		흑연 Graphite				
반경 Radius	유효장 Effective Length	Angle $\theta$	RPM	FEED	Ap Axial Depth	Ae Radial Depth
R 0.5	20	0° 30	18,000	300	0.20	0.20
"	30	0° 30	17,100	285	0.18	0.18
"	40	0° 30	16,245	271	0.16	0.16
"	25	1°	16,740	279	0.20	0.20
"	35	1°	15,903	265	0.18	0.18
"	50	1°	15,108	252	0.16	0.16
R 0.75	30	0° 30	17,000	320	0.30	0.30
"	40	0° 30	16,150	304	0.28	0.28
"	50	0° 30	15,343	289	0.26	0.26
"	30	1°	15,300	288	0.30	0.30
"	50	1°	14,229	268	0.28	0.28
"	60	1°	13,233	249	0.26	0.26
R 1	40	0° 30	16,500	600	0.40	0.40
"	50	0° 30	14,850	540	0.36	0.36
"	70	0° 30	13,365	486	0.32	0.32
"	60	1°	12,029	437	0.36	0.36
"	90	1°	10,224	372	0.32	0.32
R 2	70	0° 30	13,500	1,600	0.80	0.80
"	80	1°	12,825	1,520	0.76	0.76
R 3	100	0° 30	11,000	2,200	1.20	1.20
"	100	1°	10,780	2,156	1.20	1.20
R 5	83	0° 30	9,600	2,250	2.00	2.00
R 6	110	0° 30	7,500	2,300	2.40	2.40

피삭재 Material		흑연 Graphite				
반경 Radius	유효장 Effective Length	Angle $\theta$	RPM	FEED	Ap Axial Depth	Ae Radial Depth
R 0.5	20	0° 30	18,900	360	0.20	0.20
"	30	0° 30	17,955	342	0.18	0.18
"	40	0° 30	17,057	325	0.16	0.16
"	25	1°	17,577	335	0.20	0.20
"	35	1°	16,698	318	0.18	0.18
"	50	1°	15,863	302	0.16	0.16
R 0.75	30	0° 30	17,850	384	0.30	0.30
"	40	0° 30	16,958	365	0.28	0.28
"	50	0° 30	16,110	347	0.26	0.26
"	40	1°	16,065	346	0.30	0.30
"	50	1°	14,940	321	0.28	0.28
"	60	1°	13,895	299	0.26	0.26
R 1	40	0° 30	17,325	720	0.40	0.40
"	50	0° 30	15,593	648	0.36	0.36
"	60	0° 30	14,702	559	0.32	0.32
"	50	1°	14,524	588	0.36	0.36
"	60	1°	12,630	525	0.32	0.32
"	70	1°	11,367	472	0.19	0.19
R 2	80	0° 30	13,466	1,824	0.80	0.80
"	100	1°	12,120	1,642	0.76	0.76

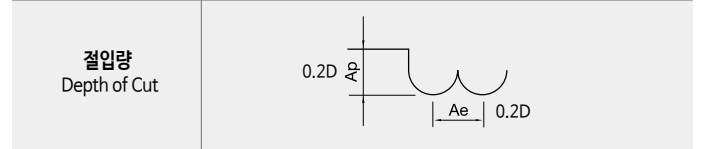
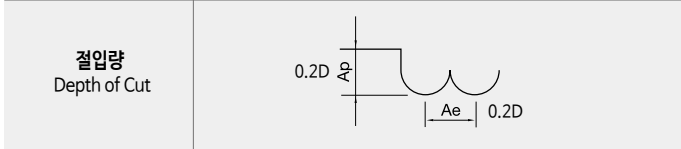

- 유효장이 긴 경우에는 회전수와 이송속도를 최대20% 이하로 줄이십시오.
- 절삭조건표에 없는 유효장은 같은 직경과 비례하여 DOWN 시켜주십시오.
- 절삭조건에 없는 각도는 같은 직경에 이전 각도와 비례하여 사용 하십시오.
- 이송속도 및 축 방향의 절입 깊이는 리브창과 테이퍼각에 따라 고려하시고, 절삭 상황에 맞추어 조정 하십시오.
- 상기 절삭조건은 참고 수치이므로 실 가공시 가공 형상, 가공 목적, 적용 기계에 따라 조건변경 요망 합니다.
- 공작기계와 가공물의 강성이 없는 경우, 진동이 발생할시 조건표에 회전속도와 이송속도를 같은 비율로 줄여서 적용 합니다.

- In case of long effective length, reduce the RPM and feed by 20% or less.
- If the effective length of your tool does not show above the table, use the shorten effective length of parameter and reduce the parameters in the same proportion.
- If there is no parameter for the angle of your tool, refer to the previous angle, and adjust compare to it.
- Adjust the value of the feed and Ap based on the effective length and taper angle, and adjust the milling condition.
- Use this table for your reference. Adjust the parameters depending on your machining geometry, machining purpose and CNC.
- In case of workpiece and machine do not have enough rigidity and make vibration, reduce the RPM and feed in same proportion.

# 2GEM/4GEM/6GEM Cutting Condition

• RPM : rev./min • Feed : mm/min

외경 Outside Diameter	2 G E M				4 G E M				6 G E M			
	RPM	FEED	Ap Axial Depth	Ae Radial Depth	RPM	FEED	Ap Axial Depth	Ae Radial Depth	RPM	FEED	Ap Axial Depth	Ae Radial Depth
Ø 1	36,000	700	1.00	0.10	-	-	-	-	-	-	-	-
Ø 2	28,000	700	2.00	0.20	-	-	-	-	-	-	-	-
Ø 3	18,000	800	3.00	0.30	18,000	1,600	3.00	0.30	-	-	-	-
Ø 4	16,000	1,000	4.00	0.40	16,000	2,000	4.00	0.40	-	-	-	-
Ø 5	15,000	1,200	5.00	0.50	15,000	2,400	5.00	0.50	-	-	-	-
Ø 6	12,000	1,300	6.00	0.60	12,000	2,600	6.00	0.60	23,400	2,880	6.00	0.60
Ø 8	10,000	1,500	8.00	0.80	10,000	3,000	8.00	0.80	19,500	3,900	8.00	0.80
Ø 10	8,000	1,400	10.00	1.00	8,000	2,800	10.00	1.00	15,600	4,800	10.00	1.00
Ø 12	6,500	1,400	12.00	1.20	6,500	2,800	12.00	1.20	12,675	4,800	12.00	1.20
Ø 16	5,800	1,300	16.00	1.60	5,800	2,600	16.00	1.60	11,310	5,400	16.00	1.60
Ø 20	5,000	1,200	20.00	2.00	5,000	2,400	20.00	2.00	9,750	5,400	20.00	2.00

**절입량**  
Depth of Cut

- 유효장 길이가 긴 경우, RPM과 FEED를 동일 비율로 낮춰 주세요.
- 날 끝이 정밀하게 연삭되어 있습니다. 파손을 피하기 위해 가능하면 비접촉 방식으로 측정 하십시오.
- 상기 절삭조건은 참고 수치이므로 실 가공시 가공 형상, 가공 목적, 적용 기계에 따라 조건변경 요망 합니다.
- 조건표가 기계의 최대 스피들 속도를 초과 하거나 버 및 적열 현상이 발생할때 스피들 속도와 이송속도를 비례하여 조정 하십시오.
- 진동이 적고 강성이 좋은 공작기계 사용 요망 합니다 (Ø1이하 사용시 진동 허용 관리 5µm이내 일것.)
- 흑연 가공시 에어브로를 추천 합니다.
- If the effective length is long, reduce the RPM and feed in the same proportion.
- The edge of the flute precisely grinded. If you want to measure the tool, and to avoid damaging on the flutes, use non-contac measuring method.
- Use this table for your reference. Adjust the parameters depending on your machining geometry, machining purpose and CNC.
- If the table over the maximum RPM and feed of your machine, or found red heat on the material, adjust RPM and feed in the same proportion.
- Use a machine with low vibration and good rigidity (Ø1 or less, the vibration tolerance management should be within 5µm).
- For graphite milling, air blow method is recommended.

# 2DCR/4DCR Cutting Condition

• RPM : rev./min • Feed : mm/min

외경 Outside Diameter	2 D C R				4 D C R			
	RPM	FEED	Ap Axial Depth	Ae Radial Depth	RPM	FEED	Ap Axial Depth	Ae Radial Depth
Ø 0.2	40,000	100	0.06	0.06	-	-	-	-
Ø 0.4	40,000	230	0.12	0.12	-	-	-	-
Ø 0.5	40,000	300	0.15	0.15	-	-	-	-
Ø 0.6	40,000	400	0.18	0.18	-	-	-	-
Ø 0.8	40,000	630	0.24	0.24	-	-	-	-
Ø 1	35,000	800	0.30	0.30	-	-	-	-
Ø 2	25,000	920	0.60	0.60	25,000	1,840	0.60	0.60
Ø 3	16,500	920	0.90	0.90	16,500	1,840	0.90	0.90
Ø 4	15,000	1,300	1.20	1.20	15,000	2,600	1.2	1.2
Ø 5	14,000	1,600	1.50	1.50	-	-	-	-
Ø 6	11,000	1,700	1.80	1.80	11,000	3,390	1.8	1.8
Ø 8	-	-	-	-	8,000	2,030	2.4	2.4
Ø 10	-	-	-	-	6,500	1,700	3.0	3.0
Ø 12	-	-	-	-	5,500	1,700	3.6	3.6
Ø 16	-	-	-	-	5,500	1,500	4.8	4.8

**절입량**  
Depth of Cut

경사진면절삭  
Inclined Cutting

- 유효장이 긴 경우에는 회전수와 이송속도를 최대20% 이하로 줄이십시오.
- 곡면 절삭시 날경의 코너R 보다 낮은 이동 PITCH를 설정 하십시오.
- 곡면 절삭시 안정적인 속도 내에서 피드를 최대 50%까지 UP 해주십시오.
- 홈 절삭시 날경의 코너R 대비 Ae 값을 설정 하십시오.
- 상기 절삭조건은 참고 수치이므로 실 가공시 가공 형상, 가공 목적, 적용 기계에 따라 조건변경 요망 합니다.
- 적절한 쿨런트 사용과 가공시 발열, 발화에 주의 하십시오.
- If the effective length is long, reduce the RPM and feed in the same proportion.
- For curved milling, set up the lower value of the pitch than the corner radius value of tool diameter.
- For curved milling, raise up the feed up to 50% in stable milling condition.
- For groove milling, set up the Ae value by considering of corner radius value.
- Use this table for your reference. Adjust the parameters depending on your machining geometry, machining purpose and CNC.
- Use the adequate coolant for work material and machining geometry and note for heat and ignition.

# 2DBE/3DBE/4DBE Cutting Condition

• RPM : rev./min • Feed : mm/min

	2DBE				3DBE				4DBE			
피삭재 Material	흑연 Graphite				흑연 Graphite				흑연 Graphite			
외경 Outside Diameter	RPM	FEED	Ap Axial Depth	Ae Radial Depth	RPM	FEED	Ap Axial Depth	Ae Radial Depth	RPM	FEED	Ap Axial Depth	Ae Radial Depth
Ø 1	16,000	400	0.20	0.20	16,000	480	0.20	0.20	16,000	700	0.20	0.20
Ø 2	16,000	800	0.40	0.40	16,000	960	0.40	0.40	16,000	1,200	0.40	0.40
Ø 3	16,000	1,450	0.60	0.60	16,000	1,740	0.60	0.60	16,000	2,000	0.60	0.60
Ø 4	16,000	2,100	0.80	0.80	16,000	2,520	0.80	0.80	16,000	3,100	0.80	0.80
Ø 5	15,500	2,550	1.00	1.00	15,500	3,060	1.00	1.00	15,000	3,800	1.00	1.00
Ø 6	15,000	2,950	1.20	1.20	15,000	3,540	1.20	1.20	15,000	4,400	1.20	1.20
Ø 8	13,000	3,000	1.60	1.60	13,000	3,600	1.60	1.60	13,000	4,500	1.60	1.60
Ø 10	11,500	3,000	2.00	2.00	12,000	3,600	2.00	2.00	12,000	4,600	2.00	2.00
Ø 12	10,700	3,200	2.40	2.40	10,000	3,840	2.40	2.40	10,000	4,700	2.40	2.40

**절입량**  
Depth of Cut

- 유효장이 긴 경우에는 회전수와 이송속도를 최대20% 이하로 줄이십시오.
- 절삭 조건표에 없는 유효장은 같은 직경과 비례하여 DOWN 시켜주십시오.
- 상기 절삭조건은 참고 수치이므로 실 가공시 가공형상, 가공목적, 적용기계에 따라 조건변경 요망합니다.
- 공작기계의 가공물의 강성이 없는 경우 진동이 발생할 시 조건표에 회전속도와 이송속도를 같은 비율로 줄여서 적용합니다.
- If the effective length is long, reduce the RPM and feed maximum 20%.
- If the effective length of your tool does not show above the table, use the shorten effective length of parameter and reduce the parameters in the same proportion.
- Use this table for your reference. Adjust the parameters depending on your machining geometry, machining purpose and CNC.
- In case of workpiece and machine do not have enough rigidity and make vibration, reduce the RPM and feed in same proportion.

# 2DEM/3DEM/4&6DEM Cutting Condition

• RPM : rev./min • Feed : mm/min

	2DEM				4DEM				6DEM			
피삭재 Material	흑연 Graphite				흑연 Graphite				흑연 Graphite			
외경 Outside Diameter	RPM	FEED	Ap Axial Depth	Ae Radial Depth	RPM	FEED	Ap Axial Depth	Ae Radial Depth	RPM	FEED	Ap Axial Depth	Ae Radial Depth
Ø 0.2	40,000	100	0.3	0.02	-	-	-	-	-	-	-	-
Ø 0.4	40,000	200	0.6	0.04	-	-	-	-	-	-	-	-
Ø 0.6	40,000	350	0.9	0.06	-	-	-	-	-	-	-	-
Ø 0.8	40,000	550	1.2	0.08	-	-	-	-	-	-	-	-
Ø 1	40,000	700	1.5	0.10	-	-	-	-	-	-	-	-
Ø 2	25,000	800	3.0	0.20	-	-	-	-	-	-	-	-
Ø 3	16,500	800	4.5	0.30	16,500	1,600	4.5	0.3	-	-	-	-
Ø 4	15,000	1,200	6.0	0.40	15,000	2,400	6.0	0.4	-	-	-	-
Ø 5	14,000	1,400	7.5	0.50	14,000	2,800	7.5	0.5	-	-	-	-
Ø 6	11,000	1,500	9.0	0.60	11,000	3,000	9.0	0.6	21,450	6,200	9	0.6
Ø 8	8,000	1,800	12.0	0.80	8,000	3,600	12.0	0.8	15,600	7,400	12	0.8
Ø 10	6,500	1,200	15.0	1.00	6,500	3,000	15.0	1.0	12,675	6,200	15	1.0
Ø 12	5,500	1,500	18.0	1.20	5,500	3,000	18.0	1.2	10,725	6,200	18	1.2
Ø 16	5,500	1,300	24.0	1.60	-	-	-	-	10,725	5,300	24	1.6

**절입량**  
Depth of Cut

- 유효장 길이가 긴 경우, RPM과 FEED를 동일 비율로 낮춰 주세요.
- 날 끝이 정밀하게 연삭되어 있습니다. 파손을 피하기 위해 가능하면 비접촉 방식으로 측정 하십시오.
- 상기 절삭조건은 참고 수치이므로 실 가공시 가공형상, 가공 목적, 적용 기계에 따라 조건변경 요망 합니다.
- 조건표가 기계의 최대 스피들 속도를 초과하거나 버 및 적열 현상이 발생할때 스피들 속도와 이송 속도를 비례하여 조정 하십시오.
- 진동이 적고 강성이 좋은 공작기계 사용 요망 합니다 (Ø1이하 사용자 진동 허용 관리 5µm이내 일것.)
- 흑연 가공시 에어브로를 추천 합니다.
- If the effective length is long, reduce the RPM and feed in the same proportion.
- The edge of the flute precisely grinded. If you want to measure the tool, and to avoid damaging on the flutes, use non-contact measuring method.
- Use this table for your reference. Adjust the parameters depending on your machining geometry, machining purpose and CNC.
- If the table over the maximum RPM and feed of your machine, or found red heat on the material, adjust RPM and feed in the same proportion.
- Use a machine with low vibration and good rigidity (Ø1 or less, the vibration tolerance management should be within 5µm).
- For graphite milling, air blow method is recommended.



# 2CPB Cutting Condition

• RPM : rev./min • Feed : mm/min

피삭재 Material	CFRP				GFRP			
	반경 Radius	RPM	FEED	Ap Axial Depth	Ae Radial Depth	RPM	FEED	Ap Axial Depth
R 0.25	28,000	273	0.05	0.05	13,720	112	0.05	0.05
R 0.3	25,760	315	0.06	0.06	12,622	129	0.06	0.06
R 0.4	18,816	399	0.08	0.08	9,220	164	0.08	0.08
R 0.5	17,920	420	0.1	0.1	8,781	172	0.1	0.1
R 1	17,920	840	0.2	0.2	8,781	344	0.2	0.2
R 2	17,920	2,205	0.4	0.4	8,781	904	0.4	0.4
R 3	16,800	3,098	0.6	0.6	8,232	1,270	0.6	0.6
R 4	14,560	3,150	0.8	0.8	7,134	1,292	0.8	0.8
R 5	12,880	3,360	1	1	6,311	1,378	1	1
R 6	11,200	3,308	1.2	1.2	5,488	1,356	1.2	1.2

**절입량**  
Depth of Cut

- 유효장 길이가 긴 경우, RPM과 FEED를 동일 비율로 낮춰 최대 20% 이하로 줄이십시오.
- 유효장에 따라 같은 직경에 비례하여 회전수와 이송속도를 DOWN 시켜주십시오.
- 상기 절삭조건은 참고 수치이므로 실 가공시 가공형상, 가공목적, 적용기계에 따라 조건변경 요망합니다.
- 공작기계와 가공물의 강성이 없는 경우, 진동이 발생할 시 조건표에 회전속도와 이송속도를 같은 비율로 줄여서 적용합니다.
- If the effective length is long, reduce the RPM and feed in the same proportion.
- If the effective length of your tool does not show above the table, use the shorten effective length of parameter and reduce the parameters in the same proportion.
- Use this table for your reference. Adjust the parameters depending on your machining geometry, machining purpose and CNC.
- In case of workpiece and machine do not have enough rigidity and make vibration, reduce the RPM and feed in same proportion.

# 8 ~12CPE Cutting Condition

• RPM : rev./min • Feed : mm/min

피삭재 Material	CFRP				GFRP			
	외경 Outside Diameter	RPM	FEED	Ap Axial Depth	Ae Radial Depth	RPM	FEED	Ap Axial Depth
∅ 6	8,400	840	6	2.1	4116	378	6	2.1
∅ 8	6,200	860	8	2.8	3038	387	8	2.8
∅ 10	5,100	780	10	3.5	2499	351	10	3.5
∅ 12	4,150	750	12	4.2	2034	338	12	4.2

**절입량**  
Depth of Cut

- 유효장 길이가 긴 경우, RPM과 FEED를 동일 비율로 낮춰 최대 20% 이하로 줄이십시오.
- 날 끝이 정밀하게 연삭되어 있습니다. 파손을 피하기 위해 가능하면 비접촉 방식으로 측정하십시오.
- 상기 조건은 8날 기준이며 날 수가 증가시 같은 직경에 비례하여 회전수와 이송속도를 UP 시켜주십시오.
- 상기 절삭조건은 참고 수치이므로 실 가공시 가공형상, 가공 목적, 적용 기계에 따라 조건변경 요망 합니다.
- 조건표가 기계의 최대 스피indle 속도를 초과하거나 버 및 적열 현상이 발생할 때 스피indle 속도와 이송 속도를 비례하여 조정하십시오.
- 에어브로, 절삭유, 오일 미스트 클린터를 추천하며, 칩을 잘 제거하고 가공시 발열과 발화에 주의 하십시오
- In case of long effective length, reduce the RPM and feed by 20% or less.
- The edge of the flute precisely grinded. If you want to measure the tool, and to avoid damaging on the flutes, use non-contact measuring method.
- Above the value of the table is based on 8 flutes. If you use more than 8 flutes of endmill, raise up the RPM and Feed in a same proportion compared to the same diameter.
- Use this table for your reference. Adjust the parameters depending on your machining geometry, machining purpose and CNC.
- If the table over the maximum RPM and feed of your machine, or found red heat on the material, adjust RPM and feed in the same proportion.
- Air blow or mist coolants are recommended and note for chip emission, heat, or ignition.

피삭재 Material	CFRP			
외경 Outside Diameter	RPM	FEED	Ap Axial Depth	Ae Radial Depth
ø 6	8,000	600	6	2.4
ø 8	6,000	600	8	3.2
ø 10	4,800	540	10	4.0
ø 12	4,000	540	12	4.8

# 4&6CPR DIA Coating

피삭재 Material	4 CPR				6 CPR											
	CFRP		GFRP		CFRP		GFRP									
외경 Outside Diameter	RPM	FEED	Ap Axial Depth	Ae Radial Depth	RPM	FEED	Ap Axial Depth	Ae Radial Depth	RPM	FEED	Ap Axial Depth	Ae Radial Depth	RPM	FEED	Ap Axial Depth	Ae Radial Depth
ø 6	7,900	1,100	6	2.4	4,200	430	6	2.4	10,500	1,950	1.8	0.12	5,300	740	1.8	0.12
ø 8	5,960	1,600	8	3.2	3,200	590	8	3.2	7,970	2,950	2.4	0.16	3,900	950	2.4	0.16
ø 10	4,750	1,500	10	4.0	2,550	560	10	4.0	6,350	2,930	3	0.20	3,120	850	3	0.20
ø 12	3,950	2,060	12	4.8	2,120	725	12	4.8	5,300	3,900	3.6	0.24	2,600	1,050	3.6	0.24

절입량 Depth of Cut	CFRP	GFRP
		

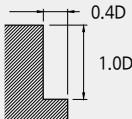
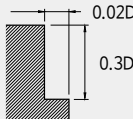
- 유효장 길이가 긴 경우, RPM과 FEED를 동일 비율로 낮춰 최대 20% 이하로 줄이십시오.
- 날 끝이 정밀하게 연삭되어 있습니다. 파손을 피하기 위해 가능하면 비접촉 방식으로 측정하십시오.
- 상기 절삭조건은 참고 수치이므로 실 가공시 가공 형상, 가공 목적, 적용 기계에 따라 조건변경 요망 합니다.
- 조건표가 기계의 최대 스피들 속도를 초과하거나 버 및 적열 현상이 발생할때 스피들 속도와 이송 속도를 비례하여 조정하십시오.
- 에어브로, 절삭유, 오일 미스트 쿨런트를 추천하며, 칩을 잘 제거하고 가공시 발열과 발화에 주의 하십시오

- In case of long effective length, reduce the RPM and feed by 20% or less.
- The edge of the flute precisely grinded. If you want to measure the tool, and to avoid damaging on the flutes, use non-contact measuring method.
- Use this table for your reference. Adjust the parameters depending on your machining geometry, machining purpose and CNC.
- If the table over the maximum RPM and feed of your machine, or found red heat on the material, adjust RPM and feed in the same proportion.
- Air blow or mist coolants are recommended and note for chip emission, heat, or ignition.

# 6 ~16CPO Cutting Condition

피삭재 Material	CFRP				GFRP			
외경 Outside Diameter	RPM	FEED	Ap Axial Depth	Ae Radial Depth	RPM	FEED	Ap Axial Depth	Ae Radial Depth
ø 4	15,900	1,400	8	1.4	15,900	1,400	8	1.4
ø 5	13,000	1,900	10	1.8	13,000	1,900	10	1.8
ø 6	10,600	2,200	12	2.1	10,600	2,200	12	2.1
ø 8	7,950	2,600	16	2.8	7,950	2,600	16	2.8
ø 10	6300	3050	20	3.5	6300	3050	20	3.5
ø 12	5300	3300	24	4.2	5300	3300	24	4.2

절입량 Depth of Cut	CFRP	GFRP
		

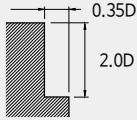
- 유효장 길이가 긴 경우, RPM과 FEED를 동일 비율로 낮춰 최대 20% 이하로 줄이십시오.
- 날 끝이 정밀하게 연삭되어 있습니다. 파손을 피하기 위해 가능하면 비접촉 방식으로 측정 하십시오.
- 상기 조건은 8날 기준이며 날 수가 증가시 같은 직경에 비례하여 회전수와 이송속도를 UP 시켜주십시오.
- 상기 절삭조건은 참고 수치이므로 실 가공시 가공 형상, 가공 목적, 적용 기계에 따라 조건변경 요망 합니다.
- 조건표가 기계의 최대 스피들 속도를 초과하거나 버 및 적열 현상이 발생할때 스피들 속도와 이송속도를 비례하여 조정하십시오.
- 에어브로, 절삭유, 오일 미스트 쿨런트를 추천하며, 칩을 잘 제거하고 가공시 발열과 발화에 주의 하십시오

- In case of long effective length, reduce the RPM and feed by 20% or less.
- The edge of the flute precisely grinded. If you want to measure the tool, and to avoid damaging on the flutes, use non-contact measuring method.
- Above the value of the table is based on 8 flutes. If you use more than 8 flutes of endmill, raise up the RPM and Feed in a same proportion compared to the same diameter.
- Use this table for your reference. Adjust the parameters depending on your machining geometry, machining purpose and CNC.
- If the table over the maximum RPM and feed of your machine, or found red heat on the material, adjust RPM and feed in the same proportion.
- Air blow or mist coolants are recommended and note for chip emission, heat, or ignition.

피삭재 Material	CFRP			
외경 Outside Diameter	RPM	FEED	V/C	Fz
Ø 2	15,900	960	100 ~ 150	0.03 ~ 0.07
Ø 2.5	12,700	760	"	"
Ø 3	10,600	630	"	"
Ø 4	7,960	480	"	"
Ø 5	6,370	380	"	"
Ø 6	5,300	320	"	"
Ø 8	3,980	240	"	"
Ø 9	3,540	210	"	"
Ø 10	3,180	190	"	"
Ø 11	2,890	175	"	"
Ø 12	2,650	160	"	"

- 상기조건은 V/C 100, Fz 0.03 기준이며, 실가공시 가공목적, 적용기계에 따라 조건변경요망합니다.
- 조건표가 기계의 최대 스피드속도를 초과할 시 스피드속도와 이송속도를 비례하여 조정하십시오.
- 에어브로, 절삭유, 오일미스트 쿨런트를 추천하며, 칩을 잘 제거하고 가공시 발열과 발화에 주의하십시오.
- Above the parameters are based on V/C 100 with Fz 0.03. Actual machining can be changed depending on your machining purpose and condition of your machine.
- If the table over the maximum RPM and feed of your machine, or found red heat on the material, adjust RPM and feed in the same proportion.
- Air blow or mist coolants are recommended and note for chip emission, heat, or ignition.

# 3SUE Cutting Condition

피삭재 Material	스테인레스강 / 티타늄 합금강 Stainless Steel / Titanium alloy steels SUS304 / SUS316 / Ti6A				고경도강 STAVAX / SKD11				내열합금강 Heat Resistance Alloys			
경도 Hardness	45 ~ 55HRc											
외경 Outside Diameter	RPM	FEED	Ap Axial Depth	Ae Radial Depth	RPM	FEED	Ap Axial Depth	Ae Radial Depth	RPM	FEED	Ap Axial Depth	Ae Radial Depth
Ø 0.8	6,400	80	1.2	0.16	7,800	210	0.8	0.04	2,000	20	0.8	0.04
Ø 1	5,600	90	1.5	0.20	7,000	210	1.0	0.05	1,700	30	1.0	0.05
Ø 2	4,800	100	3.0	0.40	5,800	238	1.5	0.08	1,400	40	1.5	0.08
Ø 3	4,000	120	4.5	0.60	4,400	315	2.5	0.13	1,400	50	2.5	0.13
Ø 4	3,300	180	6.0	0.80	3,600	490	3.0	0.15	1,200	70	3.0	0.15
Ø 5	2,700	220	7.5	1.00	3,000	630	4.0	0.20	1,000	90	4.0	0.20
Ø 6	2,400	230	9.0	1.20	2,800	630	5.0	0.25	900	90	5.0	0.25
Ø 8	1,800	250	12.0	1.50	2,000	700	7.0	0.35	720	80	7.0	0.35
Ø 10	1,400	250	14.0	1.80	1,800	770	9.0	0.45	600	80	9.0	0.45
Ø 12	1,200	200	17.0	2.00	1,400	630	10.0	0.50	500	70	10.0	0.50
Ø 16	900	150	23.0	2.50	1,100	420	15.0	0.75	360	60	15.0	0.75

<b>절입량 Depth of Cut</b>	
-----------------------------	--

- 유효장 길이가 긴 경우, RPM과 FEED를 동일 비율로 낮춰주세요.
- 절삭 조건이 없는 직경 및 유효장은 비슷한 직경 및 유효장에 비례하여 UP&DOWN 하여 설정 하십시오.
- 날 끝이 정밀하게 연삭되어 있습니다. 파손을 피하기 위해 가능하면 비접촉 방식으로 측정 하십시오.
- 상기 절삭조건은 참고 수치이므로 실가공시 가공형상, 가공목적, 적용기계에 따라 조건변경요망합니다.
- 조건표가 기계의 최대 스피드속도를 초과하거나 버 및 적열현상이 발생할 때 스피드속도와 이송속도를 비례하여 조정 하십시오.
- 진동이 적고 강성이 좋은 공작기계 사용 요망합니다 (Ø1이하 사용시 진동 허용 관리 5µm 이내 일것.)
- 에어브로, 절삭유, 오일 미스트 쿨런트를 추천하며, 칩을 잘 제거하고 가공시 발열과 발화에 주의 하십시오
- If the effective length is long, reduce the RPM and feed in the same proportion.
- If the diameter or effective length of your tool are not on the table, adjust it compared similarity value on the table.
- The edge of the flute precisely grinded. If you want to measure the tool, and to avoid damaging on the flutes, use non-contact measuring method.
- Use this table for your reference. Adjust the parameters depending on your machining geometry, machining purpose and CNC.
- If the table over the maximum RPM and feed of your machine, or found red heat on the material, adjust RPM and feed in the same proportion.
- Use a machine with low vibration and good rigidity (Ø1 or less, the vibration tolerance management should be within 5µm).
- If the table over the maximum RPM and feed of your machine, or found red heat on the material, adjust RPM and feed in the same proportion.

# 3SURB Cutting Condition

• RPM : rev./min • Feed : mm/min

피삭재 Material	공구강 / 금형강 Tool steels / Mold steels SCM / HPM				스테인레스강 Stainless Steel SUS304 / SUS316				고경도강 Hardened steels STAVAX / SKD11						
	경도 Hardness								30 ~ 40Hrc				45 ~ 55Hrc		
반경 Corner Radius	RPM	FEED	Ap Ae		RPM	FEED	Ap Ae		RPM	FEED	Ap Ae				
			Axial Depth	Radial Depth			Axial Depth	Radial Depth			Axial Depth	Radial Depth			
R0.5	42000	500	0.10	0.30	25000	220	0.10	0.30	9000	130	0.050	0.10			
R0.75	38000	520	0.15	0.45	17000	250	0.15	0.45	7600	185	0.075	0.15			
R1	24000	550	0.20	0.60	12700	300	0.20	0.60	6400	225	0.100	0.20			
R1.5	16000	600	0.30	0.90	8500	310	0.30	0.90	5460	272	0.150	0.30			
R2	12000	530	0.40	1.20	6400	290	0.40	1.20	4160	208	0.200	0.40			
R3	8000	350	0.60	1.80	4200	240	0.60	1.80	2730	168	0.300	0.60			
R4	5900	270	0.80	2.40	3190	240	0.80	2.40	2080	152	0.400	0.80			
R5	4700	200	1.00	3.00	2550	230	1.00	3.00	1690	144	0.500	1.00			
R6	4000	180	1.20	3.60	2100	230	1.20	3.60	1430	100	0.600	1.20			
절입량 Depth of Cut															

# 4SUB Cutting Condition

• RPM : rev./min • Feed : mm/min

피삭재 Material	공구강 / 금형강 Tool steels / Mold steels SCM / HPM				스테인레스강 Stainless Steel SUS304 / SUS316				고경도강 Hardened steels STAVAX / SKD11						
	경도 Hardness								30 ~ 40Hrc				45 ~ 55Hrc		
반경 Corner Radius	RPM	FEED	Ap Ae		RPM	FEED	Ap Ae		RPM	FEED	Ap Ae				
			Axial Depth	Radial Depth			Axial Depth	Radial Depth			Axial Depth	Radial Depth			
R1.5	13,860	707	0.3	0.9	9,600	387	0.3	0.9	5040	376	0.15	0.3			
R2	10,560	619	0.4	1.2	7,200	354	0.4	1.2	3840	287	0.2	0.4			
R2.5	8,382	575	0.5	1.5	5,760	309	0.5	1.5	3000	276	0.25	0.5			
R3	6,996	464	0.6	1.8	4,800	287	0.6	1.8	2520	232	0.3	0.6			
R4	5,280	420	0.8	2.4	3,600	287	0.8	2.4	1920	210	0.4	0.8			
R5	4,224	398	1.0	3.0	2,880	276	1.0	3.0	1560	199	0.5	1.0			
R6	3,498	398	1.2	3.6	2,400	276	1.2	3.6	1320	166	0.6	1.2			
절입량 Depth of Cut															

- 유효장 길이가 긴 경우, RPM과 FEED를 동일 비율로 낮춰주세요.
- 절삭 조건이 없는 직경 및 유효장은 비슷한 직경 및 유효장에 비례하여 UP&DOWN 하여 설정 하십시오.
- HRC55 이상 고경도강 가공시 같은 직경의 같은 비율로 20% DOWN 해주십시오.
- 상기 절삭조건은 참고 수치이므로 실 가공시 가공 형상, 가공 목적, 적용 기계에 따라 조건변경 요망 합니다.
- 적용 기계의 회전 속도가 부족한 경우에는 회전 속도와 이송속도를 같은 비율로 줄여서 적용합니다.
- 원활한 칩배출을 위하여 에어브로 혹은 미스트 클린트 사용을 추천 합니다.
- If the effective length is long, reduce the RPM and feed in the same proportion.
- If the diameter or effective length of your tool are not on the table, adjust it compared similarity value on the table.
- When milling workpiece, HRC over 55 hardened steel , reduce 20% of the RPM and feed compared to the same diameter.
- Use this table for your reference. Adjust the parameters depending on your machining geometry, machining purpose and CNC.
- If the table over the maximum RPM and feed of your machine, reduce the RPM and feed in the same proportion.
- Air blow or oil mist is recommended for smooth chip emission.

피삭재 Material	합금강 / 프리하드강 Alloy Steels / Pre-hardened Steels NAK80 / KP4M				스테인레스강 / 티타늄 합금강 Stainless Steel / Titanium alloy steels SUS304 / SUS316 / Ti6A				내열합금강 Heat Resistance Alloys			
	40 ~ 45HRC											
외경 Outside Diameter	RPM	FEED	Ap Axial Depth	Ae Radial Depth	RPM	FEED	Ap Axial Depth	Ae Radial Depth	RPM	FEED	Ap Axial Depth	Ae Radial Depth
Ø 1	18000	750	1	1	18000	232	0.5	1	6000	80	0.2	1
Ø 2	11740	820	2	2	10920	232	1	2	4990	112	0.4	2
Ø 3	8390	900	3	3	8270	352	1.5	3	4370	160	0.6	3
Ø 4	6150	800	4	4	6240	400	2	4	3330	184	0.8	4
Ø 5	5370	750	5	5	4990	416	2.5	5	2600	208	1	5
Ø 6	4480	600	6	6	4130	416	3	6	2180	208	1.2	6
Ø 8	3350	580	8	8	3120	392	4	8	1660	208	1.6	8
Ø 10	2680	560	10	10	2500	320	5	10	1350	176	2	10
Ø 12	2240	530	12	12	2100	320	6	12	1140	144	2.4	12
Ø 16	1680	500	16	16	1560	232	8	16	830	112	3.2	16
Ø 20	1340	500	20	20	1250	208	10	20	620	80	4	20



절입량 Depth of Cut			
	$\leq 1D$ (MAX. 12mm)	$\leq 0.5D$	$\leq 0.2D$

- 유효장 길이가 긴 경우, RPM과 FEED를 동일 비율로 낮춰주세요.
- 절삭 조건이 없는 직경 및 유효장은 비슷한 직경 및 유효장에 비례하여 UP&DOWN 하여 설정 하십시오.
- 날 끝이 정밀하게 연삭되어 있습니다. 파손을 피하기 위해 가능하면 비접촉 방식으로 측정 하십시오.
- 상기 절삭조건은 참고 수치이므로 실 가공시 가공 형상, 가공 목적, 적용 기계에 따라 조건변경 요망 합니다.
- 조건표가 기계의 최대 스피드 속도를 초과하거나 버 및 적열 현상이 발생할 때 스피드 속도와 이송 속도를 비례하여 조정 하십시오.
- 진동이 적고 강성이 좋은 공작기계 사용 요망 합니다 (Ø1이하 사용시 진동 허용 관리 5µm이내 일것.)
- 에어브로, 절삭유, 오일 미스트 콜러트를 추천하며, 칩을 잘 제거하고 가공시 발열과 발화에 주의 하십시오
- If the effective length is long, reduce the RPM and feed in the same proportion.
- If the diameter or effective length of your tool are not on the table, adjust it compared similarity value on the table.
- The edge of the flute precisely grinded. If you want to measure the tool, and to avoid damaging on the flutes, use non-contact measuring method.
- Use this table for your reference. Adjust the parameters depending on your machining geometry, machining purpose and CNC.
- If the table over the maximum RPM and feed of your machine, or found red heat on the material, adjust RPM and feed in the same proportion.
- Use a machine with low vibration and good rigidity (Ø1 or less, the vibration tolerance management should be within 5µm).
- If the table over the maximum RPM and feed of your machine, or found red heat on the material, adjust RPM and feed in the same proportion.

## 홈절삭 Slotting

피삭재 Material	합금강 / 프리하드강 Alloy Steels / Pre-hardened Steels NAK80 / KP4M				스테인레스강 / 티타늄 합금강 Stainless Steel / Titanium alloy steels SUS304 / SUS316 / Ti6A				내열합금강 Heat Resistance Alloys			
	40 ~ 45Hrc											
외경 Outside Diameter	RPM	FEED	Ap Axial Depth	Ae Radial Depth	RPM	FEED	Ap Axial Depth	Ae Radial Depth	RPM	FEED	Ap Axial Depth	Ae Radial Depth
ø 2	10,000	400	2	2	9,600	310	1	2	3,200	80	0.4	2
ø 3	6,900	410	3	3	7,400	380	1.5	3	2,700	110	0.6	3
ø 4	5,600	490	4	4	5,600	400	2	4	2,000	120	0.8	4
ø 5	4,500	630	5	5	4,500	410	2.5	5	1,600	130	1	5
ø 6	3,700	740	6	6	3,700	440	3	6	1,300	160	1.2	6
ø 7	3,200	700	7	7	3,200	410	3.5	7	1,100	140	1.4	7
ø 8	2,800	670	8	8	2,800	390	4	8	1,000	130	1.6	8
ø 9	2,500	600	9	9	2,500	350	4.5	9	900	130	1.8	9
ø 10	2,200	530	10	10	2,200	350	5	10	800	130	2	10
ø 11	2,000	530	11	11	2,000	320	5.5	11	720	120	2.2	11
ø 12	1,900	530	12	12	1,900	300	6	12	660	110	2.4	12
ø 16	1,400	390	16	16	1,400	280	8	16	500	80	3.2	16
ø 20	1,100	350	20	20	1,100	260	10	20	400	60	4	20

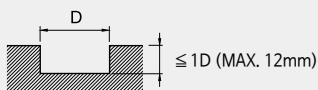
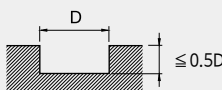

절입량 Depth of Cut			
---------------------	---	--	---

## 측면절삭 Side Cutting

피삭재 Material	합금강 / 프리하드강 Alloy Steels / Pre-hardened Steels NAK80 / KP4M				스테인레스강 / 티타늄 합금강 Stainless Steel / Titanium alloy steels SUS304 / SUS316 / Ti6A				내열합금강 Heat Resistance Alloys			
	40 ~ 45Hrc											
외경 Outside Diameter	RPM	FEED	Ap Axial Depth	Ae Radial Depth	RPM	FEED	Ap Axial Depth	Ae Radial Depth	RPM	FEED	Ap Axial Depth	Ae Radial Depth
ø 2	21,000	825	3	0.4	14,000	420	3	0.2	4,800	130	3	0.1
ø 3	15,000	938	4.5	0.6	10,600	638	4.5	0.3	4,200	200	4.5	0.15
ø 4	11,000	1,050	6	0.8	8,000	720	6	0.4	3,200	220	6	0.2
ø 5	9,600	1,425	7.5	1	6,400	750	7.5	0.5	2,500	250	7.5	0.25
ø 6	8,000	1,650	9	1.2	5,300	750	9	0.6	2,100	250	9	0.3
ø 7	6,800	1,425	10.5	1.4	4,500	750	10.5	0.7	1,800	260	10.5	0.35
ø 8	6,000	1,200	12	1.6	4,000	720	12	0.8	1,600	260	12	0.4
ø 9	5,300	1,110	13.5	1.8	3,500	630	13.5	0.9	1,400	220	13.5	0.45
ø 10	4,800	1,080	15	2	3,200	578	15	1	1,300	210	15	0.5
ø 11	4,400	1,013	16.5	2.2	2,900	570	16.5	1.1	1,200	190	16.5	0.55
ø 12	4,000	938	18	2.4	2,700	570	18	1.2	1,100	180	18	0.6
ø 16	3,000	855	24	3.2	2,000	420	24	1.6	800	130	24	0.8
ø 20	2,400	645	30	4	1,600	383	30	2	600	100	30	1

절입량 Depth of Cut			
---------------------	---	---	---

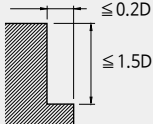
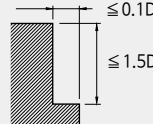
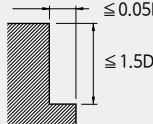
- 유효장 길이가 긴 경우, RPM과 FEED를 동일 비율로 낮춰주세요.
- 가공 진입시 가능한 피삭재 밖에서 진입 하십시오.
- 절삭 조건이 없는 직경 및 유효장은 비슷한 직경 및 유효장에 비례하여 UP & DOWN 하여 설정 하십시오.
- 날 끝이 정밀하게 연삭되어 있습니다. 파손을 피하기 위해 가능하면 비접촉 방식으로 측정 하십시오.
- 상기 절삭조건은 참고 수치이므로 실 가공시 가공 형상, 가공 목적, 적용 기계에 따라 조건변경 요망 합니다.
- 조건표가 기계의 최대 스피들 속도를 초과하거나 버 및 적열 현상이 발생할 때 스피들 속도와 이송 속도를 비례하여 조정 하십시오.
- 에어브로, 절삭유, 오일 미스트 쿨런트를 추천하며, 칩을 잘 제거하고 가공시 발열과 발화에 주의하십시오

- If the effective length is long, reduce the RPM and feed in the same proportion.
- When entering the tool to the workpiece, enter the tool from outside to the workpiece.
- If the diameter or effective length of your tool are not on the table, adjust it compared similarity value on the table.
- The edge of the flute precisely grinded. If you want to measure the tool, and to avoid damaging on the flutes, use non-contact measuring method.
- Use this table for your reference. Adjust the parameters depending on your machining geometry, machining purpose and CNC.
- If the table over the maximum RPM and feed of your machine, or found red heat on the material, adjust RPM and feed in the same proportion.
- Air blow or mist coolants are recommended and note for chip emission, heat, or ignition.

# 4SUCR Cutting Condition

• RPM : rev./min • Feed : mm/min

피삭재 Material	합금강 / 프리하든강 Alloy Steels / Pre-hardened Steels NAK80 / KP4M				스테인레스강 / 티타늄 합금강 Stainless Steel / Titanium alloy steels SUS304 / SUS316 / Ti6A				내열합금강 Heat Resistance Alloys			
	40 ~ 45HRc											
외경 Outside Diameter	RPM	FEED	Ap Axial Depth	Ae Radial Depth	RPM	FEED	Ap Axial Depth	Ae Radial Depth	RPM	FEED	Ap Axial Depth	Ae Radial Depth
Ø 1	13,210	357	0.3	0.5	10,836	339	0.3	0.5	5,820	78	0.1	0.3
Ø 2	11,270	518	0.6	1.0	9,391	339	0.6	1.0	4,840	109	0.2	0.6
Ø 3	8,054	588	0.9	1.5	7,112	515	0.9	1.5	4,239	155	0.3	0.9
Ø 4	5,904	657	1.2	2.0	5,366	585	1.2	2.0	3,230	178	0.4	1.2
Ø 5	5,155	887	1.5	2.5	4,291	608	1.5	2.5	2,522	202	0.5	1.5
Ø 6	4,301	1037	1.8	3.0	3,552	608	1.8	3.0	2,115	202	0.6	1.8
Ø 8	3,216	749	2.4	4.0	2,683	573	2.4	4.0	1,610	202	0.8	2.4
Ø 10	2,573	657	3.0	5.0	2,150	468	3.0	5.0	1,310	171	1.0	3.0
Ø 12	2,150	576	3.6	6.0	1,806	468	3.6	6.0	1,106	140	1.2	3.6
Ø 16	1,613	541	4.8	8.0	1,342	339	4.8	8.0	805	109	1.6	4.8
Ø 20	1,286	404	6.0	10.0	1,075	304	6.0	10.0	601	78	2.0	6.0
절입량 Depth of Cut												

- 유효장 길이가 긴 경우, RPM과 FEED를 동일 비율로 낮춰주세요.
- 절삭 조건이 없는 직경 및 유효장은 비슷한 직경 및 유효장에 비례하여 UP&DOWN 하여 설정 하십시오.
- 날 경의 코너R 대비 Ae 값을 설정 하십시오.
- 상기 절삭조건은 참고 수치이므로 실 가공시 가공 형상, 가공 목적, 적용 기계에 따라 조건변경 요망 합니다.
- 조건표가 기계의 최대 스피들 속도를 초과하거나 버 및 적열 현상이 발생할 때 스피들 속도와 이송속도를 비례하여 조정 하십시오.
- 진동이 적고 강성이 좋은 공작기계 사용 요망 합니다 (Ø1이하 사용시 진동 허용 관리 5µm이내 일것.)
- 에어브로, 절삭유, 오일 미스트 클린트를 추천하며, 칩을 잘 제거하고 가공시 발열과 발화에 주의 하십시오
- If the effective length is long, reduce the RPM and feed in the same proportion.
- If the diameter or effective length of your tool are not on the table, adjust it compared similarity value on the table.
- Consider the corner radius value when you set up the Ae value.
- Use this table for your reference. Adjust the parameters depending on your machining geometry, machining purpose and CNC.
- If the table over the maximum RPM and feed of your machine, or found red heat on the material, adjust RPM and feed in the same proportion.
- Use a machine with low vibration and good rigidity (Ø1 or less, the vibration tolerance management should be within 5µm).
- If the table over the maximum RPM and feed of your machine, or found red heat on the material, adjust RPM and feed in the same proportion.

# 4LSUC Cutting Condition

• RPM : rev./min • Feed : mm/min

피삭재 Material	합금강 / 프리하든강 Alloy Steels / Pre-hardened Steels NAK80 / KP4M				스테인레스강 / 티타늄 합금강 Stainless Steel / Titanium alloy steels SUS304 / SUS316 / Ti6A				내열합금강 Heat Resistance Alloys			
	40 ~ 45HRc											
외경 Outside Diameter	RPM	FEED	Ap Axial Depth	Ae Radial Depth	RPM	FEED	Ap Axial Depth	Ae Radial Depth	RPM	FEED	Ap Axial Depth	Ae Radial Depth
Ø 1	14,300	380	0.5	1	9,600	310	0.5	1	4,770	80	0.2	1
Ø 2	8,500	400	1.0	2	9,600	310	1.0	2	3,000	100	0.4	2
Ø 3	6,900	410	1.5	3	7,400	380	1.5	3	2,700	110	0.6	3
Ø 4	5,600	490	2.0	4	5,600	400	2.0	4	2,000	120	0.8	4
Ø 5	4,500	630	2.5	5	4,500	410	2.5	5	1,600	130	1.0	5
Ø 6	3,700	740	3.0	6	3,700	440	3.0	6	1,300	160	1.2	6
Ø 7	3,200	700	3.5	7	3,200	410	3.5	7	1,100	140	1.4	7
Ø 8	2,800	670	4.0	8	2,800	390	4.0	8	1,000	130	1.6	8
Ø 10	2,200	530	5.0	10	2,200	350	5.0	10	800	130	2.0	10
Ø 11	2,000	530	5.5	11	2,000	320	5.5	11	720	120	2.2	11
Ø 12	1,900	530	6.0	12	1,900	300	6.0	12	660	110	2.4	12
Ø 16	1,400	390	8.0	16	1,400	280	8.0	16	500	80	3.2	16
Ø 20	1,100	350	10.0	20	1,100	260	10.0	20	400	60	4.0	20
절입량 Depth of Cut												

# 3&4&5SUR Cutting Condition

• RPM : rev./min • Feed : mm/min

피삭재 Material	스테인레스강/ 티탄합금 Stainless Steels / Titanium Alloy Steels			
	SUS304 / SUS 316 / Ti6A			
외경 Outside Diameter	RPM	FEED	Ap Axial Depth	Ae Radial Depth
Ø 3	5,000	380	0.9	3
Ø 4	4,800	350	1.2	4
Ø 5	4,700	350	1.5	5
Ø 6	4,400	340	1.5	6
Ø 7	3,800	340	1.75	7
Ø 8	3,300	340	2	8
Ø 9	3,000	340	2.25	9
Ø 10	2,700	330	2.5	10
Ø 12	2,200	330	1.8	12
Ø 14	2,000	310	2.1	14
Ø 16	1,750	300	2.4	16
Ø 20	1,300	210	2	20

<b>절입량</b> Depth of Cut		A : Ø3 ~ 5 = 0.3 x D Ø6 ~ 10 = 0.25 x D Ø12 ~ 16 = 0.15 x D Ø18 ~ 20 = 0.1 x D
----------------------------	--	--

- 가공 진입시 가능한 피삭재 밖에서 진입 하십시오.
- 유효장이 긴 경우에는 회전수와 이송속도를 최대30% 이하로 줄이십시오.
- 상기 절삭조건은 참고 수치이므로 실 가공시 가공 형상, 가공 목적, 적용 기계에 따라 조건변경 요망 합니다.
- 공작기계의 가공물의 강성이 없는 경우 진동이 발생할시 조건표에 회전 속도와 이송속도를 같은 비율로 줄여서 적용 합니다.
- 피삭재와 가공 모양에 따라 적절한 쿨란트를 사용 하십시오.
- 스테인레스, 내열합금강 등의 절단 가공시 수용성 절삭유가 가장 효과적입니다.
- When entering the tool to the workpiece, enter the tool from outside to the workpiece.
- If the effective length is long, reduce the RPM and feed maximum 30%.
- Use this table for your reference. Adjust the parameters depending on your machining geometry, machining purpose and CNC.
- If the table over the maximum RPM and feed of your machine, or found red heat on the material, adjust RPM and feed in the same proportion.
- In case of workpiece and machine do not have enough rigidity and make vibration, reduce the RPM and feed in same proportion.
- Depending on the workpiece and shape, use adequate coolant.
- For parting off stainless or hear resistant alloy, using water-soluble oil is the most effective way.

# 2COB Cutting Condition

• RPM : rev./min • Feed : mm/min

피삭재 Material	동합금 Copper Alloys C1100							
	$\alpha \leq 15^\circ$				$\alpha > 15^\circ$			
반경 Corner Radius	RPM	FEED	Ap Axial Depth	Ae Radial Depth	RPM	FEED	Ap Axial Depth	Ae Radial Depth
R 0.5	40,000	5,200	0.06	0.1	40,000	3,200	0.06	0.1
R 0.75	40,000	6,240	0.09	0.15	40,000	4,000	0.09	0.15
R 1	40,000	6,240	0.11	0.2	39,000	4,700	0.11	0.2
R 1.5	40,000	7,800	0.12	0.3	30,000	4,500	0.12	0.3
R 2	40,000	7,800	0.13	0.4	27,000	4,300	0.13	0.4
R 2.5	32,000	7,150	0.15	0.5	20,000	3,600	0.15	0.5
R 3	25,000	5,850	0.2	0.6	16,000	2,900	0.2	0.6
R 4	21,000	5,460	0.25	0.8	13,000	2,600	0.25	0.8
R 5	16,000	4,160	0.3	1	10,000	2,000	0.3	1
R 6	13,000	3,380	0.5	1.2	8,000	1,700	0.5	1.2
R 8	9,000	2,340	0.5	1.6	6,000	1,300	0.5	1.6

<b>절입량</b> Depth of Cut	
----------------------------	--

- $\alpha$ 란 가공면의 경사각입니다.
- 유효장 길이가 긴 경우, RPM과 FEED를 동일 비율로 낮춰주세요.
- 원활한 칩배출을 위하여 수용성 절삭유제의 사용을 추천합니다.
- 적용 기계의 회전속도가 부족한 경우에는 회전속도와 이송속도를 같은 비율로 줄여서 적용 합니다.
- $\alpha$  value represents a slope of workpiece.
- If the effective length is long, reduce the RPM and feed in the same proportion.
- Using Water-soluble oil is recommended for smooth chip emission.
- If the parameters exceed the maximum RPM and feed of your machine, reduce the RPM and feed in the same proportion.



			홈절삭 Slotting				측면절삭 Side Cutting			
피삭재 Material			동/ 동합금 C1100 Copper / Copper Alloys				동/ 동합금 C1100 Copper / Copper Alloys			
외경 Outside Diameter	반경 Corner Radius	유효장 Effective Length	RPM	FEED	Ap Axial Depth	Ap Radial Depth	RPM	FEED	Ap Axial Depth	Ap Radial Depth
∅ 1	R0.1, R0.2	3	45,000	2,500	0.036	1	45,000	4,500	0.036	0.2
"	"	6	40,000	2,000	0.03	1	40,000	3,000	0.03	0.2
"	"	10	35,000	1,600	0.025	1	35,000	2,000	0.025	0.2
∅ 1.5	R0.1, R0.2	5	23,000	1,800	0.08	1.5	50,000	6,000	0.08	0.3
"	"	8	26,000	1,600	0.06	1.5	45,000	5,500	0.06	0.3
"	"	12	30,000	1,500	0.05	1.5	40,000	4,500	0.04	0.3
∅ 2	R0.1, R0.2	6	35,000	1,800	0.14	2	45,000	5,000	0.12	0.8
"	"	10	30,000	1,600	0.12	2	40,000	4,700	0.1	0.6
"	"	14	30,000	1,200	0.08	2	30,000	3,800	0.06	0.4
∅ 3	R0.2, R0.3	10	30,000	2,200	0.14	3	40,000	6,500	0.12	1
"	"	16	20,000	2,000	0.12	3	35,000	6,000	0.1	0.6
"	"	20	20,000	2,000	0.12	3	35,000	6,000	0.1	0.6
"	R0.5	10	20,000	2,600	0.14	3	38,000	10,000	0.12	0.8
"	"	16	20,000	2,200	0.12	3	35,000	8,000	0.1	0.6
"	"	20	20,000	2,200	0.12	3	35,000	8,000	0.1	0.6
∅ 4	R0.2, R0.3	12	20,000	2,600	0.5	4	40,000	8,000	0.18	0.12
"	"	16	15,000	2,400	0.3	4	32,000	5,000	0.16	0.1
"	"	20	15,000	2,000	0.25	4	32,000	5,000	0.15	0.8
"	R0.5	12	20,000	2,400	0.5	4	35,000	10,000	0.3	0.1
"	"	16	15,000	2,200	0.25	4	32,000	7,000	0.15	0.8
"	"	20	15,000	2,200	0.25	4	32,000	7,000	0.15	0.8
∅ 6	R0.3, R0.5	20	10,000	1,400	0.6	6	20,000	5,200	0.25	1.2
"	"	30	10,000	1,200	0.4	6	20,000	5,000	0.25	1.2
"	R10	20	10,000	1,800	0.6	6	20,000	9,000	0.25	1.2
"	"	30	10,000	1,500	0.4	6	20,000	7,000	0.25	1.2
∅ 8	R0.3, R0.5	25	8,000	1,000	0.3	8	15,000	5,000	0.3	1.5
"	R1	25	8,000	1,300	0.3	8	15,000	10,000	0.3	1.5
∅ 10	R0.5	30	7,000	1,300	0.3	10	13,000	7,000	0.2	1.5
"	R1.0	30	7,000	1,500	0.3	10	13,000	12,000	0.2	1.5
∅ 12	R0.5	35	6,000	1,100	0.2	12	10,000	9,000	0.15	2
"	R1.0	35	6,000	1,300	0.2	12	10,000	15,000	0.15	2

<b>절입량</b> Depth of Cut		
----------------------------	---	---

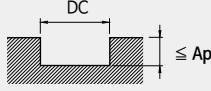
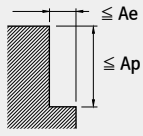
- 절삭 시 코너R 부분을 참고하여 절삭하시기 바랍니다.
- 유효장이 긴 경우에는 회전수와 이송속도를 최대 20% 이하로 줄이십시오.
- 위 절삭 조건은 2날 절삭 조건이며, 3날 가공 시 회전수는 유지하고, 피드는 안정적인 속도내에서 최대 20%까지 UP 해주십시오.
- 홈 절삭 시 날 경의 코너R 대비 Ae값을 설정 하십시오.

- Please refer to the corner R when cutting.
- If the effective length is long, reduce the rotation speed and feed rate by up to 20%.
- The above cutting conditions are for 2-flute cutting. For 3-flute cutting, maintain the rotation speed and increase the feed by up to 20% within a stable speed range.
- When cutting grooves, set the Ae value relative to the corner R of the tool's edge.

# ZDRB Cutting Condition

• RPM : rev./min • Feed : mm/min

피삭재 Material	알루미늄 합금 Aluminum Alloy Expanding Material AL7075				알루미늄 합금 주물 / 다이캐스팅 Aluminum Alloys Casting / Die Casting AC4B / Si13%				탄소섬유 / 동합금 Magnesium Alloy / Copper Alloy / CFRP AZ91 / AZ80A / C1100		동합금 Copper Alloy C1100	
	일반가공 Regular Milling		고속가공 High Speed Milling		일반가공 Regular Milling		고속가공 High Speed Milling		일반가공 Regular Milling		고속가공 High Speed Milling	
반경 Radius	RPM	FEED	RPM	FEED	RPM	FEED	RPM	FEED	RPM	FEED	RPM	FEED
R0.1	32,000	220	45,000	290	32,000	220	45,000	290	32,000	220	45,000	290
R0.3	32,000	480	45,000	660	32,000	480	45,000	660	32,000	480	45,000	660
R0.5	28,800	760	45,000	1,100	28,800	760	45,000	1,100	28,800	760	45,000	1,100
R0.8	28,800	850	45,000	1,400	28,800	850	45,000	1,400	25,200	850	35,900	1,300
R1	28,600	1,400	45,000	2,000	28,600	1,400	43,000	1,900	21,500	1,000	35,900	1,600
R1.5	19,100	1,400	45,000	3,000	19,100	1,400	28,600	1,900	14,300	1,000	23,900	1,600
R2	14,300	1,400	35,900	3,200	14,300	1,400	21,400	1,900	10,700	1,000	17,900	1,600
R3	9,500	1,400	23,900	3,200	9,500	1,400	14,300	1,900	7,200	1,000	12,000	1,600
R4	7,200	1,800	17,600	4,100	7,200	1,800	10,700	2,400	5,400	1,300	8,900	2,000
R5	5,700	1,600	14,000	3,600	5,700	1,600	8,600	2,200	4,300	1,200	7,200	1,800
R6	4,800	1,500	11,700	3,400	4,800	1,500	7,200	2,000	3,600	1,100	5,900	1,700
절입량 Depth of Cut	Ap	Ae	Ap	Ae	Ap	Ae	Ap	Ae	Ap	Ae	Ap	Ae
	0.1D	0.2D	0.05D	0.1D	0.1D	0.2D	0.05D	0.1D	0.1D	0.2D	0.02D	0.05D

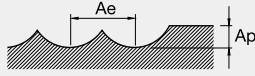

# ZDLB Cutting Condition

• RPM : rev./min • Feed : mm/min

피삭재 Material	알루미늄 합금 Aluminum Alloy Expanding Material AL7075				알루미늄 합금 주물 / 다이캐스팅 Aluminum Alloys Casting / Die Casting AC4B / Si13%				탄소섬유 / 동합금 Magnesium Alloy / Copper Alloy / CFRP AZ91 / AZ80A / C1100		동합금 Copper Alloy C1100	
	일반가공 Regular Milling		고속가공 High Speed Milling		일반가공 Regular Milling		고속가공 High Speed Milling		일반가공 Regular Milling		고속가공 High Speed Milling	
반경 Radius	RPM	FEED	RPM	FEED	RPM	FEED	RPM	FEED	RPM	FEED	RPM	FEED
R0.3	28,800	350	40,000	490	28,800	350	36,100	480	28,800	350	31,600	420
R0.5	23,400	720	31,500	950	23,400	720	25,200	900	23,400	720	20,700	800
R0.8	23,400	760	35,900	1,120	23,400	760	25,200	1,000	22,500	720	20,700	800
R1	22,500	950	31,500	1,260	22,500	950	25,200	1,100	17,100	720	20,700	800
R1.5	15,300	950	20,700	1,260	15,300	950	16,700	1,100	11,300	720	13,500	800
R2	11,300	950	15,800	1,260	11,300	950	12,600	1,100	8,600	720	10,400	800
R3	9,000	950	13,200	1,260	9,000	950	12,600	1,100	5,900	720	8,900	800
R4	6,400	1,150	11,600	1,260	6,400	1,150	9,800	1,000	4,800	880	6,400	950
R5	5,200	1,050	9,400	1,120	5,200	1,050	7,800	860	3,900	760	5,300	880
R6	4,100	1,000	6,700	950	4,100	1,000	5,400	520	3,000	740	4,600	840
절입량 Depth of Cut	Ap	Ae	Ap	Ae	Ap	Ae	Ap	Ae	Ap	Ae	Ap	Ae
	0.1D	0.2D	0.05D	0.1D	0.1D	0.2D	0.05D	0.1D	0.1D	0.2D	0.02D	0.05D

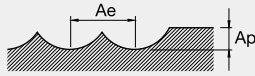

- 상기 절삭조건은 참고 수치이므로 실가공시 가공형상, 가공목적, 적용기계에 따라 조건 변경 요망합니다.
- 조건표가 기계의 최대 스피드속도를 초과하거나 버 및 적열 현상이 발생할 때 스피드속도와 이송속도를 비례하여 조정하십시오.
- 에어브로 혹은 미스트 쿨런트를 추천합니다.
- Use this table for your reference. Adjust the parameters depending on your machining geometry, machining purpose and CNC.
- If the table over the maximum RPM and feed of your machine, or found red heat on the material, adjust RPM and feed in the same proportion.
- Air blow or mist coolant is recommended.

# 2DRE/3DRE Cutting Condition

• RPM : rev./min • Feed : mm/min

피삭재 Material	알루미늄 합금 Aluminum Alloy Expanding Material AL7075				알루미늄 합금 주물 / 다이캐스팅 Aluminum Alloys Casting / Die Casting AC4B / Si13%				탄소섬유 / 동합금 Magnesium Alloy / Copper Alloy / CFRP AZ91 / AZ80A / C1100		동합금 Copper Alloy C1100	
	일반가공 Regular Milling		고속가공 High Speed Milling		일반가공 Regular Milling		고속가공 High Speed Milling		일반가공 Regular Milling		고속가공 High Speed Milling	
외경 Outside Diameter	RPM	FEED	RPM	FEED	RPM	FEED	RPM	FEED	RPM	FEED	RPM	FEED
ø 0.5	28,800	160	45,000	500	28,800	160	45,000	450	28,800	140	45,000	410
ø 0.6	28,800	180	45,000	590	28,800	180	45,000	540	28,800	160	45,000	500
ø 0.8	28,800	200	45,000	770	28,800	200	45,000	720	26,100	180	45,000	590
ø 1	28,800	200	45,000	900	28,800	200	45,000	960	20,700	200	37,800	630
ø 1.2	28,800	210	45,000	1,100	28,800	210	45,000	1,000	17,100	200	32,400	630
ø 1.5	28,800	250	45,000	1,400	28,800	250	45,000	1,100	14,000	200	26,600	630
ø 2	28,800	400	45,000	1,800	28,800	380	45,000	1,100	13,000	200	25,200	680
ø 2.5	22,500	540	43,200	1,900	22,500	540	27,900	1,100	8,600	230	18,000	680
ø 3	18,900	630	36,000	1,900	18,900	630	23,400	1,100	7,200	230	15,300	680
ø 4	14,000	650	29,700	2,000	14,000	650	18,000	1,200	5,400	250	12,600	720
ø 5	11,300	680	27,900	2,500	11,300	680	17,280	1,500	4,300	270	11,300	860
ø 6	9,500	750	23,400	2,500	9,500	750	14,310	1,500	3,600	280	9,500	900
ø 8	7,200	800	17,550	2,600	7,200	800	10,800	1,600	2,600	270	7,100	900
ø 10	5,700	900	13,950	2,900	5,700	900	8,640	1,700	2,100	330	5,700	1,000
ø 12	4,800	950	11,700	2,900	4,800	950	7,200	1,700	1,800	350	4,800	1,000
측면절삭 Side Cutting	Ap	Ae	Ap	Ae	Ap	Ae	Ap	Ae	Ap	Ae	Ap	Ae
	1.5D	0.1D	1D	0.1D	1.5D	0.1D	1D	0.1D	1.5D	0.1D	1D	0.05D
홈절삭 Slotting	Ap	Ae	Ap	Ae	Ap	Ae	Ap	Ae	Ap	Ae	Ap	Ae
	0.5D	0.8D	0.15D	0.8D	0.5D	0.8D	0.15D	0.8D	0.5D	0.8D	0.1D	0.8D
절입량 Depth of Cut												

# 2DLE Cutting Condition

• RPM : rev./min • Feed : mm/min

피삭재 Material	알루미늄합금재 Aluminum Alloy Expanding Material A7075				알루미늄합금주물 / 다이캐스팅 Aluminum Alloys Casting / Die Casting AC4B / Si13%				탄소섬유 / 동합금 Magnesium Alloy / Copper Alloy / CFRP AZ91 / AZ80A / C1100		동합금 Copper Alloy C1100	
	일반가공 Regular Milling		고속가공 High Speed Milling		일반가공 Regular Milling		고속가공 High Speed Milling		일반가공 Regular Milling		고속가공 High Speed Milling	
외경 Outside Diameter	RPM	FEED	RPM	FEED	RPM	FEED	RPM	FEED	RPM	FEED	RPM	FEED
ø 0.1	32,000	35	45,000	120	32,000	35	45,000	120	32,000	35	45,000	100
ø 0.3	32,000	60	45,000	300	32,000	60	45,000	300	32,000	60	45,000	210
ø 0.5	28,800	90	45,000	500	28,800	90	45,000	500	28,800	90	45,000	390
ø 0.8	28,800	120	45,000	700	28,800	130	45,000	700	23,000	110	45,000	500
ø 1	28,800	170	45,000	900	28,800	170	45,000	900	20,700	125	37,800	630
ø 1.5	28,800	230	40,500	1,100	28,800	230	40,500	1,100	14,000	130	26,700	630
ø 2	23,000	270	30,600	1,100	23,000	270	30,600	1,100	10,400	135	21,600	675
ø 3	15,300	460	20,700	1,100	15,300	460	20,700	1,100	7,200	200	15,300	675
ø 4	11,300	470	15,300	1,100	11,300	470	15,300	1,100	5,400	210	11,700	675
ø 5	9,000	490	12,200	1,100	9,000	490	12,200	1,100	4,300	225	9,000	675
ø 6	7,700	540	10,000	1,100	7,700	540	10,000	1,100	3,600	225	7,200	675
ø 8	6,000	600	8,200	1,200	6,000	600	8,200	1,200	2,600	300	5,900	720
ø 10	4,500	650	6,000	1,400	4,500	650	6,000	1,400	2,100	300	4,300	800
ø 12	3,100	690	4,500	1,500	3,100	690	4,500	1,500	1,600	320	3,200	850
측면절삭 Side Cutting	Ap	Ae	Ap	Ap	Ap	Ap	Ap	Ae	Ap	Ae	Ap	Ae
	1.2D	0.1D	1D	0.1D	1.2D	0.1D	1D	0.1D	1D	0.1D	1D	0.05D
홈절삭 Slotting	Ap	Ae	Ap	Ae	Ap	Ae	Ap	Ae	Ap	Ae	Ap	Ae
	0.3D	0.8D	0.15D	0.8D	0.3D	0.8D	0.15D	0.8D	0.3D	0.8D	0.1D	0.8D
절입량 Depth of Cut												

- 날 끝이 정밀하게 연삭되어 있습니다. 파손을 피하기 위해 가능하면 비접촉 방식으로 측정하십시오.
- 상기 절삭조건은 참고 수치이므로 실 가공시 가공 형상, 가공 목적, 적용 기계에 따라 조건변경 요망 합니다.
- 조건표가 기계의 최대 스피드 속도를 초과하거나 버 및 적열 현상이 발생할 때 스피드 속도와 이송 속도를 비례하여 조정 하십시오.
- 진동이 적고 강성이 좋은 공작기계 사용 요망 합니다 (ø1이하 사용시 진동 허용 관리 5μm 이내 일것.)
- 에어브로, 절삭유, 오일 미스트 콜러트를 추천하며, 칩을 잘 제거하고 가공시 발열과 발화에 주의 하십시오
- The edge of the flute precisely grinded. If you want to measure the tool, and to avoid damaging on the flutes, use non-contact measuring method.
- Use this table for your reference. Adjust the parameters depending on your machining geometry, machining purpose and CNC.
- If the table over the maximum RPM and feed of your machine, or found red heat on the material, adjust RPM and feed in the same proportion.
- Use a machine with low vibration and good rigidity (ø1 or less, the vibration tolerance management should be within 5μm).
- Air blow or mist coolant is recommended and note for chip emission, heat, or ignition.

피삭재 Material	알루미늄 합금 Aluminum Alloy Expanding Material AL7075				알루미늄 합금 주물 / 다이캐스팅 Aluminum Alloys Casting / Die Casting AC4B / Si13%				탄소섬유 / 동합금 Magnesium Alloy / Copper Alloy / CFRP AZ91 / AZ80A / C1100		동합금 Copper Alloy C1100	
	일반가공 Regular Milling		고속가공 High Speed Milling		일반가공 Regular Milling		고속가공 High Speed Milling		일반가공 Regular Milling		고속가공 High Speed Milling	
외경 Outside Diameter	RPM	FEED	RPM	FEED	RPM	FEED	RPM	FEED	RPM	FEED	RPM	FEED
∅ 1	37,500	220	50,000	1,170	37,400	220	50,000	1,170	27,000	160	49,000	820
∅ 1.5	37,500	300	50,000	1,430	37,400	300	50,000	1,430	18,000	170	34,700	820
∅ 2	30,000	350	40,000	1,430	30,000	350	40,000	1,430	13,500	180	28,000	880
∅ 3	20,000	600	27,000	1,430	20,000	600	27,000	1,430	9,400	260	20,000	880
∅ 4	15,000	610	20,000	1,430	14,700	610	20,000	1,430	7,000	270	15,200	880
∅ 6	10,000	700	13,000	1,430	10,000	700	13,000	1,430	4,700	290	9,400	880
∅ 8	7,800	780	11,000	1,560	7,800	780	10,700	1,560	3,400	390	7,700	940
∅ 10	5,900	850	7,800	1,820	5,900	850	7,800	1,820	2,700	390	5,600	1,000
∅ 12	4,000	900	5,900	1,950	4,000	900	5,900	1,950	2,100	410	4,200	1,100
측면절삭 Side Cutting	Ap	Ae	Ap	Ae	Ap	Ae	Ap	Ae	Ap	Ae	Ap	Ae
	1.2D	0.1D	1D	0.1D	1.2D	0.1D	1D	0.1D	1D	0.1D	1D	0.05D
홈절삭 Slotting	Ap	Ae	Ap	Ae	Ap	Ae	Ap	Ae	Ap	Ae	Ap	Ae
	0.3D	0.8D	0.15D	0.8D	0.3D	0.8D	0.15D	0.8D	0.3D	0.8D	0.1D	0.8D
절입량 Depth of Cut												

- 유효장이 긴 경우에는 회전수와 이송속도를 최대 20% 이하로 줄이십시오.
- 측면 절삭시 코너R 부분을 참고하여 절삭하시기 바랍니다.
- 홈 절삭시 날경의 코너R 대비 Ae 값을 설정 하십시오.
- 상기 절삭조건은 참고 수치이므로 실 가공시 가공 형상, 가공 목적, 적용 기계에 따라 조건변경 요망 합니다.
- 에어브로 혹은 미스트 쿨러를 추천하며 칩 제거 주의 및 가공시 발열, 발화에 주의 하십시오.

- In case of long effective length, reduce the RPM and feed by 20% or less.
- Refer to the corner radius value for side milling
- Consider the corner radius value when you set up the Ae value.
- Use this table for your reference. Adjust the parameters depending on your machining geometry, machining purpose and CNC.
- Air blow or mist coolant is recommended and note for chip emission, heat, or ignition.

## 3ALR/3ALE

피삭재 Material	알루미늄합금 Aluminum Alloys etc AL7075							
외경 Outside Diameter	3ALR Type				3ALE Type			
	RPM	FEED			RPM	FEED		
		수직 Vertical	홈절삭 Solting	측면절삭 Side Milling		수직 Vertical	홈절삭 Solting	측면절삭 Side Milling
∅ 1	35,000	150	585	715	32,000	130	501	605
∅ 2	30,000	225	1,170	1,398	25,500	190	995	1,170
∅ 3	21,600	225	1,300	1,560	18,400	190	1,100	1,300
∅ 4	16,200	300	1,300	1,560	14,000	255	1,100	1,300
∅ 5	13,000	300	1,300	1,560	11,000	255	1,100	1,300
∅ 6	10,800	300	1,300	1,560	9,200	255	1,100	1,300
∅ 8	8,100	300	1,300	1,560	7,000	255	1,100	1,300
∅ 10	6,480	250	1,300	1,560	5,500	210	1,100	1,300
∅ 12	5,400	200	1,300	1,560	4,400	170	1,100	1,300
∅ 16	-	-	-	-	3,200	130	995	1,235
∅ 20	-	-	-	-	2,000	85	884	1,105
Milling Amount (mm)		Ap=0.75D	Ap=0.75D	Ap=0.75D/ Ae=0.3D		Ap=0.75D	Ap=0.75D	Ap=0.75D/ Ae=0.3D
절입량 Depth of Cut								

# 2ALB Cutting Condition

• RPM : rev./min • Feed : mm/min

피삭재 Material	알루미늄 합금 Aluminum Alloys AL7075				동합금 Copper Alloys C1100			
반경 Radius	RPM	FEED	Ap Axial Depth	Ae Radial Depth	RPM	FEED	Ap Axial Depth	Ae Radial Depth
0.25R	40,000	700	0.01	0.025	34,000	2,000	0.015	0.05
0.3R	40,000	800	0.012	0.03	34,000	2,300	0.018	0.06
0.4R	40,000	1,050	0.016	0.04	34,000	2,580	0.024	0.08
0.5R	40,000	1,200	0.02	0.05	34,000	2,880	0.03	0.1
0.6R	40,000	1,650	0.024	0.06	34,000	3,250	0.036	0.12
0.75R	40,000	1,950	0.03	0.075	34,000	3,600	0.045	0.15
1R	40,000	2,170	0.04	0.1	33,150	4,230	0.06	0.2
1.25R	37,000	2,250	0.05	0.125	28,500	4,100	0.075	0.25
1.5R	33,125	2,300	0.06	0.15	25,500	4,050	0.09	0.3
2R	23,125	2,450	0.08	0.2	22,950	3,870	0.12	0.4
2.5R	19,125	2,500	0.1	0.25	17,000	3,240	0.15	0.5
3R	16,250	2,500	0.12	0.3	31,600	2,610	0.18	0.6
4R	11,875	2,500	0.16	0.4	11,050	2,340	0.24	0.8
5R	10,000	2,200	0.2	0.5	8,500	2,200	0.3	1
6R	8,125	2,170	0.24	0.6	6,800	2,050	0.36	1.2
8R	7,500	2,000	0.32	0.8	5,100	2,000	0.48	1.6

**절입량**  
Depth of Cut

- 유효장 길이가 긴 경우, RPM과 FEED를 동일 비율로 낮춰주세요.
- 원활한 칩배출을 위하여 수용성 절삭유제의 사용을 추천합니다.
- 적용 기계의 회전속도가 부족한 경우에는 회전 속도와 이송속도를 같은 비율로 줄여서 적용합니다.
- 상기 절삭조건은 참고 수치이므로 실 가공시 가공 형상, 가공 목적, 적용 기계에 따라 조건 변경 요망합니다.
- 진동이 적고 강성이 좋은 공작기계 사용 용망합니다. ( $\phi 1$  이하 사용시 진동 허용 관리  $5\mu m$  이내일것)
- 원활한 칩배출을 위하여 에어브로 혹은 미스트 콜러트 사용을 추천하며, 동 가공시 습식 콜러트를 추천합니다.
- If the effective length is long, lower RPM and FEED at the same ratio.
- We recommend using a soluble cutting fluid for smooth chip evacuation.
- If the rotation speed of the applied machine is insufficient, reduce the rotation speed and feed rate at the same ratio.
- The above cutting conditions are numerical values, so they may need to be adjusted depending on the actual machining shape, machining purpose, and applied machine.
- Please use a rigid and low-vibration machine (vibration tolerance within  $5\mu m$  for  $\phi 1$  or below).
- For smooth chip evacuation, we recommend using air blow or mist coolant, and for non-ferrous materials, we recommend using wet coolant during machining

# 2ALE Cutting Condition

• RPM : rev./min • Feed : mm/min

피삭재 Material	알루미늄 합금 Aluminum Alloys AL7075				알루미늄 합금 주물 Aluminum Alloys AC4B			
	측면가공 Side Milling		홈가공 Slotting		측면가공 Side Milling		홈가공 Slotting	
외경 Outside Diameter	RPM	FEED	RPM	FEED	RPM	FEED	RPM	FEED
$\phi 1$	34,000	500	34,000	400	34,000	400	34,000	300
$\phi 2$	34,000	950	32,300	720	32,300	720	27,200	470
$\phi 3$	27,200	1,200	21,300	800	21,300	800	18,000	510
$\phi 4$	20,400	1,300	16,000	850	16,000	850	14,000	550
$\phi 5$	16,200	1,400	13,000	850	13,000	850	11,000	600
$\phi 6$	13,600	1,600	11,000	940	11,000	940	9,400	640
$\phi 8$	10,200	1,600	8,000	1,000	8,000	1,000	6,800	680
$\phi 10$	8,100	1,600	6,500	1,000	6,500	1,000	5,400	680
$\phi 12$	6,800	1,600	5,400	1,000	5,400	1,000	4,500	680
$\phi 16$	5,100	1,600	4,100	1,000	4,100	1,000	3,400	610
$\phi 20$	4,100	1,300	3,200	850	3,200	850	2,700	560

**절입량**  
Depth of Cut

- 날 끝이 정밀하게 연삭되어 있습니다. 파손을 피하기 위해 가능하면 비접촉 방식으로 측정 하십시오.
- 상기 절삭조건은 참고 수치이므로 실 가공시 가공 형상, 가공 목적, 적용 기계에 따라 조건변경 요망 합니다.
- 조건표가 기계의 최대 스피indle 속도를 초과하거나 버 및 적열 현상이 발생할 때 스피indle 속도와 이송 속도를 비례하여 조정 하십시오.
- 에어브로, 절삭유, 오일 미스트 콜러트를 추천하며, 칩을 잘 제거하고 가공시 발열과 발화에 주의하십시오
- The edge of the flute precisely grinded. If you want to measure the tool, and to avoid damaging on the flutes, use non-contact measuring method.
- Use this table for your reference. Adjust the parameters depending on your machining geometry, machining purpose and CNC.
- If the table over the maximum RPM and feed of your machine, or found red heat on the material, adjust RPM and feed in the same proportion.
- Air blow or mist coolants are recommended and note for chip emission, heat, or ignition.

# 3FALE Cutting Condition

• RPM : rev./min • Feed : mm/min

외경 Outside Diameter	홈절삭 Slotting				측면절삭 Side Cutting			
	RPM	FEED	Ap Axial Depth	Ae Radial Depth	RPM	FEED	Ap Axial Depth	Ae Radial Depth
∅ 6	8,000	1,000	6	6	8,000	1,200	15	1.8
∅ 8	6,000	1,000	8	8	6,000	1,200	20	2.4
∅ 10	4,800	1,000	10	10	4,800	1,200	25	3
∅ 12	4,000	1,000	12	12	4,000	1,200	30	3.6
∅ 16	3,000	1,000	16	16	3,000	1,200	40	4.8

절입량 Depth of Cut		
---------------------	---	---

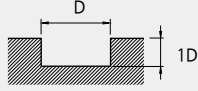
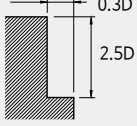
- 가공 진입시 가능한 피삭재 밖에서 진입 하십시오.
- 유효장이 긴 경우에는 회전수와 이송속도를 최대 20% 이하로 줄이십시오.
- 상기 절삭조건은 참고 수치이므로 실 가공시 가공 형상, 가공 목적, 적용 기계에 따라 조건변경 요망 합니다.
- 공작기계와 가공물의 강성이 없는 경우 진동이 발생할시 조건표에 회전 속도와 이송 속도를 같은 비율로 줄여서 적용 합니다.
- 피삭재와 가공 모양에 따라 적절한 클린트를 사용 하십시오.

- When entering the tool to the workpiece, enter the tool from outside to the workpiece.
- In case of long effective length, reduce the RPM and feed by 20% or less.
- Use this table for your reference. Adjust the parameters depending on your machining geometry, machining purpose and CNC.
- In case of workpiece and machine do not have enough rigidity and make vibration, reduce the RPM and feed in same proportion.
- Depending on the workpiece and shape, use adequate coolant.

# 4ALE Cutting Condition

• RPM : rev./min • Feed : mm/min

외경 Outside Diameter	측면가공 Side Milling		홈가공 Solting		측면가공 Side Milling		홈가공 Solting	
	RPM	FEED	RPM	FEED	RPM	FEED	RPM	FEED
∅3	12,800	975	12,880	825	5,796	439	5,796	330
∅4	9,800	975	9,800	825	4,410	439	4,410	330
∅5	7,700	975	7,700	825	3,465	439	3,465	330
∅6	6,440	975	6,440	825	2,898	439	2,898	330
∅8	4,900	975	4,900	825	2,205	439	2,205	330
∅10	3,850	975	3,850	825	1,733	439	1,733	330
∅12	3,080	975	3,080	825	1,386	439	1,386	330
∅16	2,240	926	2,240	746	1,008	417	1,008	298
∅20	1,400	829	1,400	663	630	373	630	265

절입량 Depth of Cut				
---------------------	---	---	--	---

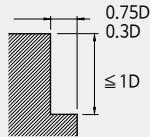
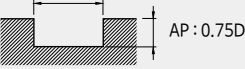
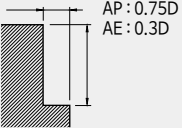
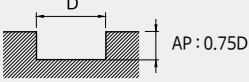
- 높은 이송속도로 절삭시 절삭날의 배출되는 칩의 응착되어, 안정적인 절삭조건을 먼저 확인해 해주세요.
- 날 끝이 정밀하게 연삭되어 있습니다. 파손을 피하기 위해 가능하면 비접촉 방식으로 측정하십시오.
- 상기 절삭조건은 참고 수치이므로 실 가공시 가공 형상, 가공 목적, 적용 기계에 따라 조건 변경 요망합니다.
- 조건표가 기계의 최대 스피드 속도를 초과하거나 버 및 적열 현상이 발생할 때 스피드 속도와 이송 속도를 비례하여 조정하십시오.
- 에어브로, 절삭유, 오일 미스트 클린트를 추천하며, 칩을 잘 제거하고 가공시 발열과 발화에 주의하십시오.
- 측면가공 후 좋지않은 표면의 세로결이 생긴다면 홀더의 클램핑과 콜렛의 체결을 확인하십시오.

- When cutting at a high feed rate, check the stability of the cutting conditions first, as chip adhesion may occur on the cutting edge.
- The cutting edge is precisely ground. To prevent breakage, try to measure without contacting the edge if possible.
- The above cutting conditions are numerical values, so they may need to be adjusted depending on the actual machining shape, machining purpose, and applied machine.
- We recommend using air blow, cutting oil, or oil mist coolant to remove chips effectively and pay attention to heat generation and ignition during machining.
- If vertical lines appear on the surface after side milling, check the clamping of the holder and the fastening of the collet.

# 3ALC Cutting Condition

• RPM : rev./min • Feed : mm/min

피삭재 Material	홈절삭 Slotting				측면절삭 Side Cutting			
	알루미늄 합금 Aluminum Alloys AL7075				알루미늄 합금 Aluminum Alloys AL7075			
외경 Outside Diameter	RPM	FEED	Ap Axial Depth	Ae Radial Depth	RPM	FEED	Ap Axial Depth	Ae Radial Depth
∅ 6	10,000	3,300	3	6	10,000	4,200	4.8	1.8
∅ 8	9,000	2,700	4	8	9,000	3,750	6.4	2.4
∅ 10	7,500	2,000	5	10	7,500	3,000	8	3
∅ 12	6,500	1,600	6	12	6,500	2,700	9.6	3.6
∅ 16	5,000	1,600	8	16	5,000	2,700	12.8	4.8
∅ 20	4,000	1,500	10	20	4,000	2,500	16	6

절입량 Depth of Cut	홈절삭 Slotting	측면절삭 Side Cutting
		

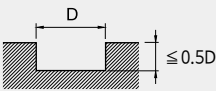
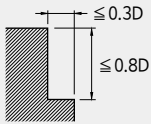
- 유효장 길이가 긴 경우, RPM과 FEED를 동일 비율로 낮춰 최대 20% 이하로 줄이십시오.
- 측면 절삭시 코너R 부분을 참고하여 절삭 하시기 바랍니다.
- 홈 절삭시 날경의 코너R 대비 Ae 값을 설정 하십시오.
- 상기 절삭조건은 참고 수치이므로 실 가공시 가공 형상, 가공 목적, 적용 기계에 따라 조건변경 요망 합니다.
- 에어브로, 절삭유, 오일 미스트 콜러트를 추천하며, 칩을 잘 제거하고 가공시의 발열과 발화에 주의하십시오

- In case of long effective length, reduce the RPM and feed by 20% or less.
- Refer to the corner radius value for side milling.
- Consider the corner radius value when you set up the Ae value.
- Use this table for your reference. Adjust the parameters depending on your machining geometry, machining purpose and CNC.
- Air blow or mist coolants are recommended and note for chip emission, heat, or ignition.

# 3ALCB Cutting Condition

• RPM : rev./min • Feed : mm/min

피삭재 Material	알루미늄합금 Aluminum Alloys A7075				알루미늄 합금 주물 Aluminum Alloys AC4B				비철금속 Non-ferrous			
	측면가공 Side Milling		홈가공 Soltting		측면가공 Side Milling		홈가공 Soltting		측면가공 Side Milling		홈가공 Soltting	
외경 Outside Diameter	RPM	FEED	RPM	FEED	RPM	FEED	RPM	FEED	RPM	FEED	RPM	FEED
∅3	40,300	3,600	37,000	2,200	26,500	1,600	15,900	1,200	47,700	5,700	40,000	3,600
∅4	30,250	4,080	27,800	2,500	19,900	2,400	12,000	1,450	35,820	6,450	30,000	4,000
∅5	25,500	5,080	22,300	2,780	15,900	2,800	9,550	1,720	28,600	6,880	24,200	4,350
∅6	21,200	5,700	18,500	2,900	13,270	2,900	7,960	1,790	23,800	7,100	20,170	4,800
∅8	15,900	6,200	14,000	3,700	9,950	2,300	5,970	2,150	17,900	7,500	15,100	5,450
∅10	12,800	5,700	11,200	4,000	7,960	2,150	4,770	2,290	14,300	8,100	12,100	5,800
∅12	10,600	5,400	9,250	3,600	6,630	2,980	3,980	2,000	12,000	7,500	10,080	6,050
∅16	8,560	4,700	7,000	3,100	4,970	2,680	3,000	1,700	8,950	6,780	7,560	5,200
∅20	6,850	4,100	5,570	2,800	3,980	2,300	2,400	1,450	7,170	5,800	6,050	4,550

절입량 Depth of Cut	측면가공 Side Milling	홈가공 Soltting	측면가공 Side Milling	홈가공 Soltting	측면가공 Side Milling	홈가공 Soltting
						

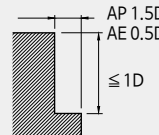
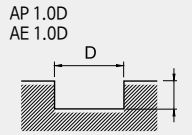
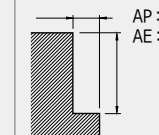
- 가공 진입시 가능한 피삭재 밖에서 진입 하십시오
- 절삭 조건이 없는 직경 및 유효장은 비슷한 직경 및 유효장에 비례하여 UP&DOWN 하여 설정하십시오.
- 상기 절삭조건은 참고 수치이므로 실 가공시 가공 형상, 가공 목적, 적용 기계에 따라 조건 변경 요망합니다.
- 적용 기계의 회전속도가 부족한 경우에는 회전 속도와 이송속도를 같은 비율로 줄여서 적용합니다.
- 진동이 적고 강성이 좋은 공작기계 사용 요망합니다. (∅1 이하 사용자 진동 허용 관리 5µm이내일것.)
- 원활한 칩배출을 위하여 수용성 콜러트 사용을 추천합니다.

- During tool entry, try to enter from outside the workpiece as much as possible.
- For diameters and effective lengths without specific cutting conditions, set them proportionally UP&DOWN to similar diameters and effective lengths.
- The above cutting conditions are numerical values, so they may need to be adjusted depending on the actual machining shape, machining purpose, and applied machine.
- If the rotation speed of the applied machine is insufficient, reduce the rotation speed and feed rate at the same ratio.
- Please use a rigid and low-vibration machine (vibration tolerance within 5µm for ∅1 or below).
- We recommend using a soluble coolant for smooth chip evacuation.

# 3ARE/3ARC Cutting Condition

• RPM : rev./min • Feed : mm/min

피삭재 Material	동 Copper alloys C1100						알루미늄 합금 Aluminum alloys AL7075					
			홈절삭 Slotting		측면절삭 Side Cutting				홈절삭 Slotting		측면절삭 Side Cutting	
외경 Outside Diameter	RPM	FEED	Ap Axial Depth	Ae Radial Depth	Ap Axial Depth	Ae Radial Depth	RPM	FEED	Ap Axial Depth	Ae Radial Depth	Ap Axial Depth	Ae Radial Depth
∅ 6	4,200	1,500	6	6	15	1.8	8,000	1,800	6	6	15	1.8
∅ 8	3,200	1,500	8	8	20	2.4	6,000	1,800	8	8	20	2.4
∅ 10	2,600	1,500	10	10	25	3	4,800	1,800	10	10	25	3
∅ 12	2,100	1,500	12	12	30	3.6	4,000	1,800	12	12	30	3.6
∅ 16	1,600	1,500	16	16	40	4.8	3,000	1,800	16	16	40	4.8
∅ 20	1,300	1,500	20	20	50	6	2,400	1,800	20	20	50	6

절입량  
Depth of Cut

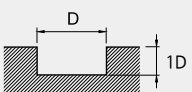

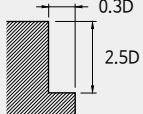

- 가공진입시 가능한 피삭재 밖에서 진입하십시오.
- 유효장이 긴 경우에는 회전수와 이송속도를 최대 20% 이하로 줄이십시오.
- 상기 절삭조건은 참고 수치이므로 실 가공시 가공 형상, 가공 목적, 적용 기계에 따라 조건변경 요망합니다.
- 공작기계와 가공물의 강성이 없는 경우 진동이 발생할시 조건표에 회전 속도와 이송속도를 같은 비율로 줄여서 적용 합니다.
- 피삭재와 가공 모양에 따라 적절한 쿨런트를 사용 하십시오.

- When entering the tool to the workpiece, enter the tool from outside to the workpiece.
- In case of long effective length, reduce the RPM and feed by 20% or less.
- Use this table for your reference. Adjust the parameters depending on your machining geometry, machining purpose and CNC.
- In case of workpiece and machine do not have enough rigidity and make vibration, reduce the RPM and feed in same proportion.
- Depending on the workpiece and shape, use adequate coolant.

# 3ARO Cutting Condition

• RPM : rev./min • Feed : mm/min

피삭재 Material	측면절삭 Side Cutting							
	알루미늄 합금 Aluminum Alloys AL7075				알루미늄 합금 주물 Aluminum Alloys AC4B			
외경 Outside Diameter	RPM	FEED	Ap Axial Depth	Ae Radial Depth	RPM	FEED	Ap Axial Depth	Ae Radial Depth
∅ 4	22,500	4,200	6	1	16,000	1,800	6	1
∅ 5	20,250	4,900	7.5	1.25	14,400	2,000	7.5	1.25
∅ 6	18,225	5,500	9	1.5	11,700	2,100	9	1.5
∅ 8	13,500	5,400	12	2	9,000	2,200	12	2
∅ 10	10,800	5,200	15	2.5	7,200	2,100	15	2.5
∅ 12	8,775	4,800	18	3	5,900	1,900	18	3
∅ 16	6,750	4,600	24	4	4,500	1,800	24	4
∅ 20	5,400	4,300	30	5	3,600	1,700	30	5

절입량  
Depth of Cut

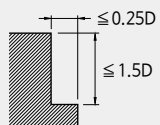

- 가공 진입시 가능한 피삭재 밖에서 진입 하십시오.
- 유효장이 긴 경우에는 회전수와 이송속도를 최대 20% 이하로 줄이십시오.
- 상기 절삭조건은 참고 수치이므로 실 가공시 가공 형상, 가공 목적, 적용 기계에 따라 조건변경 요망 합니다.
- 공작기계와 가공물의 강성이 없는 경우 진동이 발생할시 조건표에 회전 속도와 이송속도를 같은 비율로 줄여서 적용 합니다.
- 피삭재와 가공 모양에 따라 적절한 쿨런트를 사용 하십시오.

- When entering the tool to the workpiece, enter the tool from outside to the workpiece.
- In case of long effective length, reduce the RPM and feed by 20% or less.
- Use this table for your reference. Adjust the parameters depending on your machining geometry, machining purpose and CNC.
- In case of workpiece and machine do not have enough rigidity and make vibration, reduce the RPM and feed in same proportion.
- Depending on the workpiece and shape, use adequate coolant.



피삭재 Material			합금강/프리하드강 Alloy Steels / Pre-hardened Steels NAK80 / KP4M				고경도강 Hardened Steels STAVAX / SKD11				열처리 / 고경도강 Heat-treated steels / Hardened Steels SKD11 / SKD61			
경도 Hardness			40 ~ 45HRc				45 ~ 55HRc				55~ 62HRc			
반경 Radius	유효장 Effective Length	각도 Taper Angle	RPM	FEED	Ap Axial Depth	Ae Radial Depth	RPM	FEED	Ap Axial Depth	Ae Radial Depth	RPM	FEED	Ap Axial Depth	Ae Radial Depth
R 0.5	12	1°	38,000	1,375	0.110	0.16	35,000	880	0.080	0.13	25,000	440	0.050	0.08
"	20	1°	38,000	1,375	0.060	0.09	35,000	880	0.050	0.07	25,000	440	0.030	0.05
"	15	2°	38,000	1,375	0.090	0.14	35,000	880	0.070	0.11	25,000	440	0.050	0.07
"	20	2°	38,000	1,375	0.060	0.09	35,000	880	0.050	0.07	25,000	440	0.030	0.05
"	15	3°	38,000	1,375	0.090	0.14	35,000	880	0.070	0.11	25,000	440	0.050	0.07
"	20	3°	38,000	1,375	0.060	0.09	35,000	880	0.050	0.07	25,000	440	0.030	0.05
"	20	4°	38,000	1,375	0.070	0.1	35,000	880	0.060	0.08	25,000	440	0.030	0.05
"	20	5°	38,000	1,375	0.080	0.11	35,000	880	0.060	0.09	25,000	440	0.040	0.06
"	20	7°	38,000	1,375	0.080	0.11	35,000	880	0.060	0.09	25,000	440	0.040	0.06
R 1	12	1°	35,000	1,540	0.400	0.27	30,000	990	0.140	0.22	15,000	550	0.090	0.14
"	20	1°	35,000	1,540	0.180	0.21	30,000	990	0.110	0.17	15,000	550	0.070	0.11
"	15	2°	35,000	1,540	0.400	0.24	30,000	990	0.130	0.19	15,000	550	0.080	0.12
"	20	2°	35,000	1,540	0.160	0.21	30,000	990	0.110	0.17	15,000	550	0.070	0.11
"	15	3°	35,000	1,540	0.400	0.24	30,000	990	0.130	0.19	15,000	550	0.080	0.12
"	20	3°	35,000	1,540	0.300	0.21	30,000	990	0.110	0.17	15,000	550	0.070	0.11
"	30	3°	35,000	1,540	0.160	0.2	30,000	990	0.12	0.18	15,000	550	0.08	0.12
"	20	4°	35,000	1,540	0.400	0.21	30,000	990	0.110	0.17	15,000	550	0.070	0.11
"	20	5°	35,000	1,540	0.15	0.22	30,000	990	0.12	0.18	15,000	550	0.08	0.12
"	30	5°	35,000	1,540	0.13	0.2	30,000	990	0.11	0.18	15,000	550	0.07	0.12
"	29	6°	35,000	1,540	0.14	0.2	30,000	990	0.1	0.18	15,000	550	0.07	0.12
"	25	7°	35,000	1,540	0.15	0.25	30,000	990	0.12	0.18	15,000	550	0.07	0.11
R 2	20	1°	24,000	1,925	0.23	0.34	20,000	1,375	0.18	0.27	12,000	825	0.11	0.17
"	20	2°	24,000	1,925	0.23	0.34	20,000	1,375	0.18	0.27	12,000	825	0.11	0.17
"	21	3°	24,000	1,925	0.23	0.34	20,000	1,375	0.18	0.27	12,000	825	0.11	0.17
"	20	4°	24,000	1,925	0.23	0.34	20,000	1,375	0.18	0.27	12,000	825	0.11	0.17
"	20	5°	24,000	1,925	0.24	0.37	20,000	1,375	0.19	0.29	12,000	825	0.12	0.18
"	20	6°	24,000	1,925	0.22	0.32	20,000	1,375	0.17	0.25	12,000	825	0.1	0.16
"	18	7°	24,000	1,925	0.23	0.34	20,000	1,375	0.18	0.27	12,000	825	0.11	0.17
R 3	32	1°	16,000	1,925	0.23	0.41	13,500	1,375	0.23	0.35	8,000	825	0.14	0.21
"	30	2°	16,000	1,925	0.25	0.42	13,500	1,375	0.23	0.35	8,000	825	0.14	0.21
"	22	3°	16,000	1,925	0.3	0.45	13,500	1,375	0.24	0.36	8,000	825	0.15	0.23
"	40	3°	16,000	1,925	0.2	0.4	13,500	1,375	0.2	0.35	8,000	825	0.13	0.19
"	25	4°	16,000	1,925	0.22	0.43	13,500	1,375	0.22	0.36	8,000	825	0.14	0.2
"	21	5°	16,000	1,925	0.25	0.45	13,500	1,375	0.23	0.36	8,000	825	0.14	0.23
"	21	6°	16,000	1,925	0.25	0.45	13,500	1,375	0.23	0.36	8,000	825	0.14	0.23
"	19	7°	16,000	1,925	0.21	0.43	13,500	1,375	0.25	0.36	8,000	825	0.15	0.25

**절입량**  
Depth of Cut

Ap : Axial Depth 축방향의절입깊이(mm)  
 Ae : Radial Depth 반경방향의절입깊이(mm)  
 D : Outside Diameter 외경(mm)  
 n : Speed 회전속도 (min<sup>-1</sup>)  
 Vf : Feed 이송속도 (mm/min)

- 절삭 조건에 없는 각도는 같은 직경에 이전 각도와 비례하여 사용 하십시오.
- 이송속도 및 축 방향의 절입 깊이는 테이퍼각에 따라 고려하시고, 절삭 상황에 맞추어 조정 하십시오.
- 상기 절삭조건은 참고 수치이므로 실 가공시 가공 형상, 가공 목적, 적용 기계에 따라 조건변경 요망 합니다.
- 절삭 양이 작은 경우, Feed를 최대 20% 까지 UP 시켜 주십시오.
- 칩 제거 주의 및 가공시 발열, 발화에 주의 하십시오.
- If there is no parameter for the angle of your tool, refer to the previous angle, and adjust compare to it.
- Consider the RPM and feed based on the taper angle and adjust it with milling condition.
- Use this table for your reference. Adjust the parameters depending on your machining geometry, machining purpose and CNC.
- If you want to increase metal removal rates, raise up the feed up to 20%.
- During the chip evacuation, note for heat and ignition.

피삭재 Material		흑연 Graphite				공구강 / 금형강 Tool steels / Mold steels SCM / HPM			
경도 Hardness		30 ~ 40HRc							
반경 Radius	a/2	RPM	FEED	Ap Axial Depth	Ae Radial Depth	RPM	FEED	Ap Axial Depth	Ae Radial Depth
R 0.5	10	35,000	4,200	0.22	0.3	42,000	1,950	0.09	0.05
R 0.75	10	33,000	5,250	0.27	0.3	39,000	2,860	0.10	0.05
R 1	10	32,000	6,300	0.32	0.6	38,500	3,510	0.20	0.10
R 1	15	25,000	6,000	1.18	0.6	30,000	2,730	0.20	0.10
R 1.5	10	25,000	6,000	0.39	0.8	30,000	3,120	0.30	0.10
R 2	10	16,000	4,500	0.45	1.1	20,000	2,275	0.40	0.10
R 2	30	14,500	3,700	1.18	1.1	18,000	1,950	0.40	0.10
R 3	10	12,000	4,250	0.49	1.4	14,000	2,210	0.60	0.10
R 3	20	10,500	4,000	1.18	1.4	13,200	2,015	0.60	0.10
R 4	5	9,500	4,100	0.45	1.6	11,000	2,080	0.80	0.10
R 4	10	8,000	3,850	0.45	1.6	10,000	1,950	0.80	0.10

<p><b>절입량</b> Depth of Cut</p>	<p>a/2 각도만큼의 절삭을 권장합니다.</p> 	 <p>Ap : Axial Depth 축방향의절입깊이(mm)              Ae : Radial Depth 반경방향의절입깊이(mm)              D : Outside Diameter 외경(mm)              n : Speed 회전속도 (min<sup>-1</sup>)              Vf : Feed 이송속도 (mm/min)</p>
------------------------------------	---	--

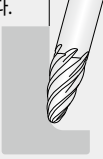
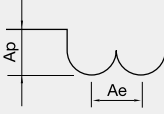
- 절삭 조건표는 4날 기준이며, 6날시에는 회전수는 유지하고, 피드는 안정적인 속도 내에서 최대30%까지 UP 해주십시오.
- 절삭 조건에 없는 각도는 같은 직경에 이전 각도와 비례하여 사용 하십시오.
- 이송속도 및 축방향의 절입 깊이는 테이퍼각에 따라 고려하시고, 절삭 상황에 맞추어 조정 하십시오.
- 5축 가공시 유효장 부분을 확인 하여 주십시오.
- 절삭량이 작은 경우, Feed를 최대 20% 까지 UP 시켜 주십시오.
- 칩 제거 주의 및 가공시 발열, 발화에 주의 하십시오.
- The parameters on the table is based on 4 flutes. For using 6 flutes, use the same RPM and raise up the feed up to 30% in stable milling condition.
- If there is no parameter for the angle of your tool, refer to the previous angle, and adjust compare to it.
- Consider the RPM and feed based on the taper angle and adjust it with milling condition.
- For 5-axis milling, check the length of the effective length before milling.
- If you want to increase metal removal rates, raise up the feed up to 20%.
- During the chip evacuation, note for heat and ignition.

# 2CTB Cutting Condition

• RPM : rev./min • Feed : mm/min

피삭재 Material	합금강/프리하드강 Alloy Steels / Pre-hardened Steels NAK80 / KP4M						고경도강 Hardened Steels STAVAX / SKD11					
	40 ~ 45HRC						45 ~ 55HRC					
경도 Hardness	$\alpha \leq 15^\circ$		$\alpha > 15^\circ$		Ap Axial Depth	Ae Radial Depth	$\alpha \leq 15^\circ$		$\alpha > 15^\circ$		Ap Axial Depth	Ae Radial Depth
	RPM	FEED	RPM	FEED			RPM	FEED	RPM	FEED		
R0.5	40,000	2,800	40,000	1,600	0.06	0.1	40,000	2,800	40,000	1,500	0.05	0.1
R0.75	40,000	3,250	40,000	2,000	0.09	0.15	40,000	3,250	32,000	1,600	0.08	0.15
R1	40,000	3,250	39,000	2,350	0.11	0.2	40,000	3,250	31,000	1,750	0.11	0.2
R1.25	40,000	3,500	30,000	2,250	0.12	0.25	36,000	3,250	26,000	1,750	0.12	0.25
R1.5	40,000	3,750	27,000	2,150	0.13	0.3	32,000	3,000	22,000	1,700	0.13	0.3
R2	32,000	3,750	20,000	1,800	0.15	0.4	25,000	3,000	16,000	1,350	0.15	0.4
R2.5	25,000	3,000	16,000	1,450	0.2	0.5	20,000	2,700	13,000	1,150	0.2	0.5
R3	21,000	2,900	13,000	1,300	0.25	0.6	17,000	2,350	10,000	1,000	0.25	0.6
R4	16,000	2,250	10,000	1,000	0.3	0.8	13,000	1,800	8,000	750	0.3	0.8
R5	13,000	1,800	8,000	850	0.5	1	10,000	1,450	6,400	600	0.5	1
R6	9,000	1,250	6,000	650	0.5	1.2	7,200	1,000	4,800	500	0.5	1.2

절입량  
Depth of Cut

- $\alpha$  란 가공면의 경사각입니다.
- 이송속도 및 축 방향의 절입 깊이는 테이퍼각에 따라 고려하시고, 절삭 상황에 맞추어 조정하십시오.
- 에어브로 혹은 미스트 쿨런트를 추천합니다.
- 상기 절삭조건은 참고 수치이므로 실 가공시 가공 형상, 가공 목적, 적용 기계에 따라 조건변경 요망 합니다.
- 칩 제거 주의 및 가공시 발열, 발화에 주의 하십시오.
- $\alpha$  value represents the inclined angle.
- Consider the RPM and feed based on the taper angle and adjust it with milling condition.
- Air blow or mist coolant is recommended.
- Use this table for your reference. Adjust the parameters depending on your machining geometry, machining purpose and CNC.
- During the chip evacuation, note for heat and ignition.

# 2CTE Cutting Condition

• RPM : rev./min • Feed : mm/min

피삭재 Material	일반구조강 / 쾌삭강 Mild steels / Free cutting steels HP / SM		구조용강 / 탄소강 / 회주철 Structural steels / Carbon Steels / Gray cast irons SS / SC / FC		공구강 / 금형강 Tool steels / Mold steels SCM / HPM		합금강 / 프리하드강 / 스테인레스강 Alloy Steels / Pre-hardened Steels / Stainless Steels NAK80 / KP4M / SUS304 / SUS316		고경도강 Hardened Steels STAVAX / SKD11	
	~200HB		~30HRc		30 ~ 40HRc		38 ~ 45HRc		45 ~ 55HRc	
외경 Outside Diameter	RPM	FEED	RPM	FEED	RPM	FEED	RPM	FEED	RPM	FEED
$\varnothing 1$	15,500	155	15,500	130	13,000	90	12,000	90	10,500	40
$\varnothing 1.5$	10,500	155	10,500	130	8,900	90	8,250	90	7,000	40
$\varnothing 2$	7,950	155	7,950	130	6,650	90	6,200	90	5,250	40
$\varnothing 2.5$	6,200	145	6,200	125	5,300	90	4,950	90	4,200	40
$\varnothing 3$	5,150	145	5,150	125	4,450	90	4,100	90	3,500	40
$\varnothing 4$	3,850	145	3,850	125	3,300	90	3,100	85	2,600	40
$\varnothing 5$	3,100	145	3,100	125	2,650	90	2,450	85	2,100	40
$\varnothing 6$	2,600	145	2,600	125	2,200	90	2,050	85	1,750	40
$\varnothing 8$	1,950	145	1,950	125	1,650	90	1,550	85	1,300	40
$\varnothing 10$	1,550	145	1,550	120	1,300	90	1,200	85	1,050	40

절입량  
Depth of Cut

Ap	Ae
2.5D	0.02D

피삭재 Material	일반구조강 / 폐삭강 Mild steels / Free cutting steels HP/SM	구조용강 / 탄소강 / 회주철 Structural steels / Carbon Steels / Gray cast irons SS/SC/FC	공구강 / 금형강 Tool steels / Mold steels SCM/HPM	합금강 / 프리하든강 / 스테인레스강 Alloy Steels / Pre-hardened Steels / Stainless Steels NAK80 / KP4M / SUS304 / SUS316	고경도강 Hardened Steels STAVAX / SKD11									
경도 Hardness	~200HB		~ 30HRc		30 ~ 40HRc		38 ~ 45HRc		45 ~ 55HRc					
외경 Outside Diameter	RPM	FEED	RPM	FEED	RPM	FEED	RPM	FEED	RPM	FEED				
∅ 3	5,300	225	4,450	225	4,450	180	4,100	130	3,500	130				
∅ 4	3,950	245	3,300	245	3,300	195	3,100	150	2,600	150				
∅ 5	3,150	275	2,650	275	2,650	225	2,450	160	2,100	160				
∅ 6	2,200	275	2,200	275	2,200	225	2,050	175	1,750	175				
∅ 8	1,950	270	1,650	270	1,650	225	1,550	190	1,300	190				
∅ 10	1,550	270	1,300	270	1,300	225	1,200	180	1,050	180				
절입량 Depth of Cut			<table border="1"> <tr> <td>Ap</td> <td>Ae</td> </tr> <tr> <td>2.5D</td> <td>0.02D</td> </tr> </table>		Ap	Ae	2.5D	0.02D						
Ap	Ae													
2.5D	0.02D													

- 절입기준은 2CTE, 4CTE 동일 합니다.
- 이송속도 및 축 방향의 절입 깊이는 테이퍼각에 따라 고려하시고, 절삭 상황에 맞추어 조정 하십시오.
- 가급적 열박음 칩을 사용하여 주십시오.
- 조건표가 기계의 최대 스피들 속도를 초과하거나 버 및 적열 현상이 발생할때 스피들 속도와 이송 속도를 비례하여 조정 하십시오.
- 에어브로, 절삭유, 오일 미스트 쿨런트를 추천하며, 칩을 잘 제거하고 가공시 발열과 발화에 주의 하십시오
- 2CTE and 4CTE type can be used the same depth of cut.
- Consider the RPM and feed based on the taper angle and adjust it with milling condition.
- Using shrink-fit chuck is recommended.
- If the table over the maximum RPM and feed of your machine, or found red heat on the material, adjust RPM and feed in the same proportion.
- Air blow or mist coolants are recommended and note for chip emission, heat, or ignition.

## 4RTE Cutting Condition

피삭재 Material	구조용강 / 탄소강 / 회주철 Structural steels / Carbon Steels / Gray cast irons SS/SC/FC	공구강 / 금형강 Tool steels / Mold steels SCM/HPM	합금강 / 프리하든강 / 스테인레스강 Alloy Steels / Pre-hardened Steels / Stainless Steels NAK80 / KP4M / SUS304 / SUS316	고경도강 Hardened Steels STAVAX / SKD11								
경도 Hardness	~ 30HRc	30HRc ~ 40HRc		38HRc ~ 45HRc								
외경 Outside Diameter	RPM	FEED	Ap	RPM	FEED	Ap	RPM	FEED	Ap	RPM	FEED	Ap
∅ 0.5	31,500	565	0.01~0.025	31,500	475	0.01~0.025	31,500	440	0.01~0.025	19,000	250	0.005~0.01
∅ 0.6	31,500	680	0.012~0.03	29,500	530	0.012~0.03	26,500	445	0.012~0.03	15,500	260	0.006~0.012
∅ 0.7	27,000	680	0.014~0.035	25,000	530	0.014~0.035	22,500	445	0.014~0.035	13,500	260	0.007~0.014
∅ 0.8	23,500	680	0.016~0.04	22,000	630	0.016~0.04	19,500	445	0.016~0.04	11,500	260	0.008~0.016
∅ 0.9	21,000	680	0.018~0.045	19,500	530	0.018~0.045	17,500	445	0.018~0.045	10,500	260	0.009~0.018
∅ 1	19,000	680	0.02~0.05	17,500	530	0.02~0.05	15,500	445	0.02~0.05	9,500	260	0.01~0.02
∅ 1.2	15,500	680	0.024~0.06	14,500	530	0.024~0.06	13,000	445	0.024~0.06	7,950	260	0.012~0.024
∅ 1.5	12,500	680	0.03~0.075	11,500	530	0.03~0.075	10,500	445	0.03~0.075	6,350	260	0.015~0.03
∅ 2	9,500	680	0.04~0.1	8,900	530	0.04~0.1	7,950	445	0.04~0.1	4,750	260	0.02~0.04
∅ 2.5	7,600	680	0.05~0.125	7,100	530	0.05~0.125	7,950	445	0.04~0.1	4,750	260	0.02~0.04
절입량 Depth of Cut												

- 날 깊이를 얻기 위해서는, 순차적으로 하나씩 목부깊이를 맞추는 것이 가장 효과적 입니다.
- 이송속도 및 축 방향의 절입 깊이는 테이퍼각에 따라 고려하시고, 절삭 상황에 맞추어 조정 하십시오.
- 코너 작업시에는 피드값을 50% 줄여 주십시오.
- 조건표가 기계의 최대 스피들 속도를 초과하거나 버 및 적열 현상이 발생할때 스피들 속도와 이송 속도를 비례하여 조정 하십시오.
- 에어브로, 절삭유, 오일 미스트 쿨런트를 추천하며, 칩을 잘 제거하고 가공시 발열과 발화에 주의 하십시오
- Consider the RPM and feed based on the taper angle and adjust it with milling condition.
- Reduce the feed by 50% for corner milling.
- If the table over the maximum RPM and feed of your machine, or found red heat on the material, adjust RPM and feed in the same proportion.
- Air blow or mist coolants are recommended and note for chip emission, heat, or ignition.

# 2CRC Cutting Condition

• RPM : rev./min • Feed : mm/min

피삭재 Material	일반구조강 / 쾌삭강 Mild steels / Free cutting steel HP / SM		구조용강 / 탄소강 / 회주철 Structural steels / Carbon Steels / Gray cast irons SS / SC / FC		공구강 / 금형강 Tool steels / Mold steels SCM / HPM	
경도 Hardness	~200HB		~30HRc		30~ 40HRc	
외경 Outside Diameter	RPM	FEED	RPM	FEED	RPM	FEED
ø 1.9	7,400	410	8,500	340	10,000	270
ø 2.9	6,600	365	7,800	300	9,230	240
ø 3.9	5,800	320	7,300	270	8,500	210
ø 4.9	5,250	300	6,500	240	7,560	190
ø 5.9	4,600	260	5,700	220	6,750	170

- 가공 진입시 가능한 피삭재 밖에서 진입 하십시오.
- R 게이지를 통해 절삭 후 측정 바랍니다.
- 상기 절삭조건은 참고 수치이므로 실 가공시 가공 형상, 가공 목적, 적용 기계에 따라 조건변경 요망 합니다.
- When entering the tool to the workpiece, enter the tool from outside to the workpiece.
- Measure after cutting through the R gauge.
- Use this table for your reference. Adjust the parameters depending on your machining geometry, machining purpose and CNC.

# 4CRC

• RPM : rev./min • Feed : mm/min

피삭재 Material	일반구조강 / 쾌삭강 Mild steels / Free cutting steel HP / SM		구조용강 / 탄소강 / 회주철 Structural steels / Carbon Steels / Gray cast irons SS / SC / FC		공구강 / 금형강 Tool steels / Mold steels SCM / HPM	
경도 Hardness	~200HB		~30HRc		30~ 40HRc	
외경 Outside Diameter	RPM	FEED	RPM	FEED	RPM	FEED
ø 1.9	5,940	630	6,800	520	8,000	420
ø 2.9	5,280	560	6,000	470	7,100	370
ø 3.9	4,700	500	5,400	420	6,300	330
ø 4.9	4,200	450	4,830	370	5,600	300
ø 5.9	3,700	410	4,250	330	5,000	270

- 가공 진입시 가능한 피삭재 밖에서 진입 하십시오.
- R 게이지를 통해 절삭 후 측정 바랍니다.
- 상기 절삭조건은 참고 수치이므로 실 가공시 가공 형상, 가공 목적, 적용 기계에 따라 조건변경 요망 합니다.
- When entering the tool to the workpiece, enter the tool from outside to the workpiece.
- Measure after cutting through the R gauge.
- Use this table for your reference. Adjust the parameters depending on your machining geometry, machining purpose and CNC.

피삭재 Material	알루미늄 합금 Aluminum AL7075		플라스틱 Plastic		ABS수지 / 아크릴 ABS resin Acrylic	
경도 Hardness						
외경 Outside Diameter	RPM	FEED	RPM	FEED	RPM	FEED
ø1.2	21,300	470	12,000	300	30,000	2,000
ø2	15,500	600	7,000	300	30,000	2,200
ø3	13,580	660	4,800	250	25,000	2,400
ø4	10,160	690	3,600	200	20,000	2,200
ø5	8,170	700	2,400	120	13,500	2,300
ø8	5,130	640	2,050	120	10,000	2,400
ø10	4,085	600	1,600	120	8,000	2,400
ø12	3,420	560	1,350	120	7,000	2,200
ø16	3,040	550	950	120	5,600	2,200

- 절삭날의 칩 응착을 주의하십시오.
- 피삭재에 진입 시 공구의 칩 뭉침을 확인하십시오.
- 상기 절삭조건은 참고 수치이므로 실 가공시 가공 형상, 가공 목적, 적용 기계에 따라 조건변경 요망 합니다.
- 조건표가 기계의 최대 스피드 속도를 초과하거나 버 및 적열 현상이 발생할 때 스피드 속도와 이송 속도를 비례 적으로 조정하십시오.
- Please be mindful of chip adhesion on the cutting edge.
- When entering the cutting material, please check for chip buildup on the tool.
- Use this table for your reference. Adjust the parameters depending on your machining geometry, machining purpose and CNC.
- If the table over the maximum RPM and feed of your machine, or found red heat on the material, adjust RPM and feed in the same proportion.

피삭재 Material	알루미늄 합금 Aluminum AL7075		플라스틱 Plastic		ABS수지 / 아크릴 ABS resin Acrylic	
경도 Hardness						
외경 Outside Diameter	RPM	FEED	RPM	FEED	RPM	FEED
ø0.9	37,000	230	14,500	300	25,000	220
ø1.2	34,000	230	11,000	320	24,000	230
ø2	20,700	230	8,500	350	12,000	230
ø3	13,800	230	6,800	380	8,000	230
ø4	10,350	250	6,200	380	6,000	230
ø6	6,900	250	5,900	400	4,000	240
ø8	5,150	250	5,000	400	3,000	240
ø10	4,140	250	4,000	400	3,000	250
ø12	3,450	250	3,300	420	2,000	250
ø16	2,588	250	2,500	420	1,400	250

- 가공 진입 시 가능한 피삭재 밖에서 진입 하십시오.
- 상기 절삭 조건은 참고는 수치이므로, 실 가공시 가공 형상, 가공 목적, 적용 기계에 따라 조건 변경 요망합니다.
- 에어브로 혹은 수용성 절삭유 또는 유성 절삭유를 추천합니다.
- When entering the tool to the workpiece, enter the tool from outside to the workpiece.
- Use this table for your reference. Adjust the parameters depending on your machining geometry, machining purpose and CNC.
- Air blow or mist coolants are recommended and note for chip emission, heat, or ignition.

# 1STE/2STE/4STE

• RPM : rev./min • Feed : mm/min

피삭재 Material	일반구조강 / 쾌삭강 Mild steels / Free cutting steel HP / SM		구조용강 / 탄소강 / 회주철 Structural steels / Carbon Steels / Gray cast irons SS / SC / FC		공구강 / 금형강 Tool steels / Mold steels SCM / HPM	
경도 Hardness	~200HB		~30HRc		30~ 40HRc	
외경 Outside Diameter	RPM	FEED	RPM	FEED	RPM	FEED
∅ 2	5,500	85	4,000	75	3,000	50
∅ 3	4,000	70	3,000	55	2,000	40
∅ 4	3,000	60	2,500	45	1,800	35
∅ 5	2,500	50	2,000	40	1,500	30
∅ 6	2,000	45	1,600	35	1,200	25
∅ 7	1,800	40	1,300	30	1,150	25
∅ 8	1,500	35	1,250	30	900	23
∅ 9	1,350	35	1,100	30	850	20
∅ 10	1,200	35	900	25	800	20
∅ 11	1,100	35	850	25	750	20
∅ 12	1,000	30	800	25	600	15

절입량 Depth of Cut	Ad : 0.05D이하	
---------------------	--------------	--

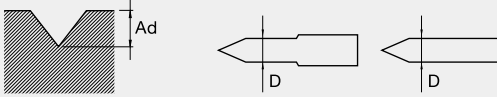
- 상기 조건은 2날 기준이며 날 수의 변경시 같은 직경에 비례하여 회전수와 이송속도를 UP/DOWN 시켜주십시오.
- 조각 가공시 엔드밀의 날 끝을 확인해 주십시오.
- 상기 절삭조건은 참고 수치이므로 실 가공시 가공 형상, 가공 목적, 적용 기계에 따라 조건변경 요망 합니다.
- The parameters on the table is based on 2 flutes. To change the number of flutes, refer to the same diameter of other parameters and then adjust it.
- For engrave machining, check the edge of the flutes.
- Use this table for your reference. Adjust the parameters depending on your machining geometry, machining purpose and CNC.

# 2CHA/3CHA Cutting Condition

• RPM : rev./min • Feed : mm/min

피삭재 Material	일반구조강 / 쾌삭강 Mild steels / Free cutting steel HP / SM		구조용강 / 탄소강 / 회주철 Structural steels / Carbon Steels / Gray cast irons SS / SC / FC		공구강 / 금형강 Tool steels / Mold steels SCM / HPM	
경도 Hardness	~200HB		~30HRc		30~ 40HRc	
외경 Outside Diameter	RPM	FEED	RPM	FEED	RPM	FEED
∅ 3	4,200	70	3,000	55	2,500	40
∅ 4	3,000	60	2,500	45	1,800	35
∅ 6	2,000	40	1,500	35	1,200	25
∅ 8	1,500	35	1,200	30	900	25
∅ 10	1,200	35	1,000	25	900	20
∅ 12	1,000	30	850	25	600	20

절입량 Depth of Cut	Ap : 0.1d Ap : Axial Depth 축방향의절입깊이(mm)	
---------------------	---	---

- 상기 조건은 2날 기준이며 날 수의 변경시 같은 직경에 비례하여 회전수와 이송속도를 UP/DOWN 시켜주십시오.
- 상기 절삭조건은 참고 수치이므로 실 가공시 가공 형상, 가공 목적, 적용 기계에 따라 조건변경 요망 합니다.
- 에어브로 혹은 수용성 절삭유 또는 유성 절삭유를 추천합니다.
- The parameters on the table is based on 2 flutes. To change the number of flutes, refer to the same diameter of other parameters and then adjust it.
- Use this table for your reference. Adjust the parameters depending on your machining geometry, machining purpose and CNC.
- Air blow, water-soluble oil, or oil mist is recommended.

# 4TES/4TRS/3TRC/4&6TDA/3&4THC/4&6TAC

3TRC는 RPM 동일, FEED만 최대 30% Down 적용.  
Use the same RPM and reduce the feed by 30% for 3TRC.

홈절삭 Slotting							
피삭재 Material	일반구조강 / 쾌삭강 Mild steels / Free cutting steel HP / SM		구조용강 / 탄소강 / 회주철 Structural steels / Carbon Steels / Gray cast irons SS / SC / FC		공구강 / 금형강 Tool steels / Mold steels SCM / HPM		
경도 Hardness	~200HB		~30HRC		30~ 40HRC		
외경 Outside Diameter	RPM	FEED	RPM	FEED	RPM	FEED	
Ø 1.5	3,050	117	1,890	77	1,530	59	
Ø 2	2,850	110	1,790	72	1,440	55	
Ø 2.5	2,680	99	1,700	66	1,350	50	
Ø 3	2,500	92	1,610	60	1,260	45	
Ø 4	2,150	81	1,430	54	1,080	41	
Ø 5	1,800	70	1,200	47	900	35	
Ø 6	1,430	59	950	39	720	30	
Ø 8	1,070	44	720	30	540	22	
Ø 10	860	35	580	23	430	17	
Ø 12	720	30	480	20	360	14	

절입량  
Depth of Cut

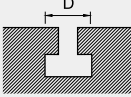

측면절삭 Side Cutting							
피삭재 Material	일반구조강 / 쾌삭강 Mild steels / Free cutting steel HP / SM		구조용강 / 탄소강 / 회주철 Structural steels / Carbon Steels / Gray cast irons SS / SC / FC		공구강 / 금형강 Tool steels / Mold steels SCM / HPM		
경도 Hardness	~200HB		~30HRC		30~ 40HRC		
외경 Outside Diameter	RPM	FEED	RPM	FEED	RPM	FEED	
Ø 1.5	3,050	162	1,890	94	1,530	76	
Ø 2	2,850	149	1,790	88	1,440	70	
Ø 2.5	2,680	135	1,700	83	1,350	65	
Ø 3	2,500	122	1,610	79	1,260	59	
Ø 4	2,150	108	1,430	72	1,080	54	
Ø 5	1,800	95	1,200	65	900	49	
Ø 6	1,430	86	950	58	720	43	
Ø 8	1,070	64	720	43	540	32	
Ø 10	860	52	580	34	430	26	
Ø 12	720	43	480	29	360	22	

절입량  
Depth of Cut

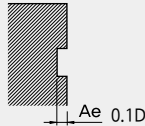

- 공구 진입시 피삭재 밖에서 진입하십시오. • 상기 절삭 조건은 4날 기준이며, 3TRC의 경우 회전수는 유지하고 Feed를 30% 줄여서 사용하십시오.
- 상기 절삭조건은 참고 수치이므로 실 가공시 가공 형상, 가공 목적, 적용 기계에 따라 조건변경 요망 합니다.
- 조건표가 기계의 최대 스피들 속도를 초과하거나 버 및 적열 현상이 발생할 때 스피들 속도와 이송 속도를 비례하여 조정하십시오.
- 측면절삭 시 떨림이 발생한 경우 절삭조건인 Feed를 줄여주십시오.
- When entering the tool to the workpiece, enter the tool from outside to the workpiece.
- The parameters on the table is based on 4 flutes. For using 3TRC , use the same RPM and reduce the feed by 30%.
- Use this table for your reference. Adjust the parameters depending on your machining geometry, machining purpose and CNC.
- If the table over the maximum RPM and feed of your machine, or found red heat on the material, adjust RPM and feed in the same proportion.
- If a vibration is occurred while side milling, reduce the feed.



# 2CEN Cutting Condition

• RPM : rev./min • Feed : mm/min

피삭재 Material	일반구조강 / 쾌삭강 Mild steels / Free cutting steel HP / SM			구조용강 / 탄소강 / 회주철 Structural steel / Carbon Steels / Gray cast iron SS / SC / FC			공구강 / 금형강 Tool steels / Mold steels SCM / HPM			알루미늄 합금 Aluminum Alloys AL7075		
	경도 Hardness	~200HB			~30HRc			30~40HRc				
외경 Outside Diameter	RPM	FEED	Ap Axial Depth	RPM	FEED	Ap Axial Depth	RPM	FEED	Ap Axial Depth	RPM	FEED	Ap Axial Depth
∅ 2	1,400	100	2	800	50	2	650	40	1	4,800	280	2
∅ 3	1,400	100	3	800	50	3	650	40	1.5	4,800	280	3
∅ 4	1,280	100	4	690	50	4	580	40	2	4,200	280	4
∅ 5	1,300	100	5	640	50	5	520	40	2.5	3,300	280	5
∅ 6	1,150	100	6	600	50	6	480	40	3	2,900	280	6
∅ 8	1,000	100	8	530	50	8	420	40	4	2,600	280	8
∅ 10	850	90	10	490	40	10	390	30	5	2,400	260	10
∅ 12	720	90	12	410	40	12	310	30	6	1,900	260	12
∅ 14	610	90	14	340	40	14	270	30	7	1,700	240	14
∅ 16	550	90	16	310	40	16	250	30	8	1,500	230	16

절입량  
Depth of Cut

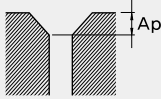

# 2CENE / 2CCMC

• RPM : rev./min • Feed : mm/min

피삭재 Material	일반구조강 / 쾌삭강 Mild steels / Free cutting steel HP / SM				구조용강 / 탄소강 / 회주철 Structural steel / Carbon Steels / Gray cast iron SS / SC / FC				공구강 / 금형강 Tool steels / Mold steels SCM / HPM				동합금 Copper alloys C1100				알루미늄 Aluminum AL7075			
	경도 Hardness	~200HB				~30HRc				30~40HRc										
외경 Outside Diameter	RPM	FEED	Ap	Ae	RPM	FEED	Ap	Ae	RPM	FEED	Ap	Ae	RPM	FEED	Ap	Ae	RPM	FEED	Ap	Ae
∅ 1	28,000	230	1.5	0.05	24,500	180	1.5	0.05	17,500	120	1.5	0.05	23,000	150	1.5	0.1	50,000	400	1.5	0.2
∅ 1.5	18,700	340	2.0	0.10	16,300	180	2.0	0.10	11,700	120	2.0	0.10	13,000	150	2.0	0.3	40,900	400	2.0	0.3
∅ 2	14,000	360	2.5	0.15	12,300	220	2.5	0.15	8,800	170	2.5	0.15	11,500	150	2.5	0.4	31,800	400	2.5	0.4
∅ 3	9,300	390	4.0	0.30	8,200	240	4.0	0.30	5,800	170	4.0	0.30	8,000	200	4.0	0.6	21,200	400	4.0	0.6
∅ 4	7,000	390	5.0	0.40	6,100	240	5.0	0.40	4,400	180	5.0	0.40	6,000	200	5.0	0.8	15,900	500	5.0	0.8
∅ 5	5,600	470	6.0	0.50	4,900	260	6.0	0.50	3,500	200	6.0	0.50	5,000	200	6.0	1	12,700	500	6.0	1
∅ 6	4,700	480	8.0	0.60	4,100	270	8.0	0.60	2,900	200	8.0	0.60	4,000	200	8.0	1.2	10,600	500	8.0	1.2
∅ 8	3,500	470	10.0	1.00	3,100	270	10.0	1.00	2,200	200	10.0	1.00	3,000	200	10.0	1.6	8,000	600	10.0	1.6
∅ 10	2,800	480	12.0	1.20	2,500	280	12.0	1.20	1,800	200	12.0	1.20	2,400	200	12.0	2	6,400	600	12.0	2
∅ 12	2,300	470	15.0	1.50	2,000	260	15.0	1.50	1,500	200	15.0	1.50	2,000	200	15.0	2.4	5,300	700	15.0	2.4

절입량  
Depth of Cut

Side Milling

- Ap : Axial Depth
- Ae : Radial Depth

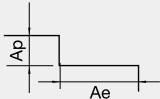

- 2CENE는 홈 절삭이 불가능하며, 2CCMC는 홈 절삭을 추천하지 않습니다.
- 상기 절삭 조건은 측면 절삭조건입니다.
- 상기 절삭조건은 참고 수치이므로 실 가공시 가공 형상, 가공 목적, 적용 기계에 따라 조건변경 요망 합니다.
- 에어브로 혹은 수용성 절삭유 또는 유성 절삭유를 추천합니다.
- Grooving with 2CENE is not possible and 2CCMC is also not recommended.
- Above parameters are for side milling.
- Use this table for your reference. Adjust the parameters depending on your machining geometry, machining purpose and CNC.
- If the table over the maximum RPM and feed of your machine, or found red heat on the material, adjust RPM and feed in the same proportion.
- If a vibration is occurred while side milling, reduce the feed.

파삭재 Material		알루미늄합금 Aluminum Alloys AL7075				플라스틱 Plastic			
반경 Corner Radius	유효장 Effective Length	RPM	FEED	Ap Axial Depth	Ap Radial Depth	RPM	FEED	Ap Axial Depth	Ap Radial Depth
R 0.1	1	35,000	420	0.003	0.03	35,000	1,000	0.05	0.03
R 0.15	2	35,000	490	0.004	0.04	35,000	1,050	0.06	0.04
R 0.2	3	35,000	560	0.005	0.06	35,000	1,100	0.07	0.06
R 0.25	4	35,000	700	0.006	0.07	28,000	1,200	0.08	0.07
"	10	27,300	504	0.004	0.05	21,840	864	0.06	0.04
R 0.3	4	35,000	910	0.007	0.09	24,000	1,200	0.1	0.09
"	10	27,300	655	0.005	0.07	18,720	864	0.07	0.05
R 0.4	4	26,000	940	0.008	0.12	18,000	900	0.13	0.12
"	10	19,500	658	0.006	0.1	13,500	576	0.11	0.1
R 0.5	6	21,000	970	0.008	0.15	14,000	700	0.17	0.15
"	16	14,700	631	0.006	0.1	9,800	455	0.1	0.09
R 0.6	6	18,000	1,010	0.009	0.18	12,000	600	0.2	0.18
"	16	12,780	616	0.007	0.11	8,520	366	0.13	0.12
R 0.7	6	15,000	1,020	0.01	0.21	10,000	500	0.23	0.21
"	16	10,800	622	0.008	0.16	7,200	305	0.17	0.15
R 0.75	6	14,000	1,010	0.012	0.24	9,500	480	0.25	0.24
"	16	10,220	636	0.01	0.19	6,935	302	0.19	0.17
"	25	8,483	477	0.008	0.14	5,756	227	0.13	0.11
R 1	8	11,000	1,100	0.18	0.35	7,000	350	0.4	0.35
"	20	8,140	704	0.16	0.3	5,180	224	0.35	0.33
"	30	6,919	528	0.14	0.25	4,403	168	0.3	0.28
R 1.5	8	6,900	760	0.2	0.5	4,800	240	0.5	0.5
"	20	5,313	486	0.18	0.45	4,080	151	0.45	0.45
"	30	4,516	365	0.16	0.4	3,142	113	0.4	0.4
R 2	16	5,200	690	0.25	0.65	3,600	180	0.6	0.65
"	25	4,056	449	0.22	0.6	3,060	113	0.56	0.61
"	35	3,488	336	0.2	0.55	2,356	85	0.54	0.57
R 2.5	16	4,200	590	0.3	0.8	2,900	150	0.8	0.85
"	25	3,234	401	0.27	0.75	2,233	102	0.76	0.81
"	35	2,652	309	0.24	0.7	1,831	79	0.72	0.75
R 3	25	3,500	550	0.35	0.9	2,400	120	1	1.2
"	35	2,940	468	0.33	0.8	2,016	102	0.95	1.1
"	50	2,323	355	0.3	0.7	1,593	78	0.9	1
R 4	-	3,300	520	0.4	1.2	2,065	130	1.3	1.6
R 5	-	2,850	500	0.5	1.5	1,615	125	1.6	2
R 6	-	2,650	470	0.6	1.8	1,350	125	2	2.4
R 7	-	2,500	450	0.8	2.4	1,000	120	2.5	3.2

절입량  
Depth of Cut

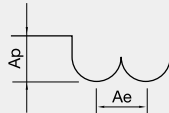

Ap : Axial Depth 축방향의절입깊이(mm)  
 Ae : Radial Depth 반경방향의절입깊이(mm)  
 D : Outside Diameter 외경 (mm)  
 n : Speed 회전속도 (min<sup>-1</sup>)  
 Vf : Feed 이송속도 (mm/min)

- 상기 절삭조건은 2날 기준이며, 3날 가공시 회전수와 Feed를 10% UP 시켜주십시오.
- 상기 절삭조건은 참고 수치이므로 실 가공시 가공 형상, 가공 목적, 적용 기계에 따라 조건변경 요망 합니다.
- 적용 기계의 회전속도가 부족한 경우에는 회전 속도와 이송속도를 같은 비율로 줄여서 적용 합니다.
- The parameters on the table is based on 2 flutes. For using 3 flutes, increase RPM and feed by 10% in stable milling condition.
- Use this table for your reference. Adjust the parameters depending on your machining geometry, machining purpose and CNC.
- If the table over the maximum RPM and feed of your machine, adjust RPM and feed in the same proportion.

피삭재 Material	ABS 수지 / 아크릴 ABS resin / Acrylic			알루미늄합금 Aluminum Alloys AL7075		
외경 Outside Diameter	RPM	FEED	Ap (Axial Depth)	RPM	FEED	Ap (Axial Depth)
R0.5	41,600	2,200	2.5	29,900	1,430	2.5
R1	41,600	2,420	5	29,900	1,650	5
R1.5	32,500	2,640	7.5	23,400	1,870	7.5
R2	26,000	2,640	10	19,500	1,980	10
R2.5	19,500	2,420	12.5	15,600	1,980	12.5
R3	17,550	2,530	15	13,000	1,980	15
R4	17,000	2,640	20	12,500	2,090	20
R5	16,000	2,640	25	12,000	2,200	25
R6	14,000	2,420	30	10,000	2,090	30
R8	13,000	2,350	40	8,700	2,000	40

**절입량**  
Depth of Cut

- 절삭날의 칩 응착을 주의하십시오.
- 최대한 공구 진입 시 피삭재 밖에서 진입하십시오.
- 상기 절삭조건은 참고 수치이므로 실 가공시 가공 형상, 가공 목적, 적용 기계에 따라 조건 변경 요망합니다.
- 조건표가 기계의 최대 스피드 속도를 초과하거나 버 및 적열 현상이 발생할 때 스피드 속도와 이송 속도를 비례하여 조정하십시오.
- Please be mindful of chip adhesion on the cutting edge.
- When entering the tool to the workpiece, enter the tool from outside to the workpiece.
- Use this table for your reference. Adjust the parameters depending on your machining geometry, machining purpose and CNC.
- If the table over the maximum RPM and feed of your machine, or found red heat on the material, adjust RPM and feed in the same proportion.

# 2MLB

• RPM : rev./min • Feed : mm/min

피삭재 Material	ABS 수지 / 아크릴 ABS resin / Acrylic			
반경 Radius	RPM	FEED	Ap Axial Depth	Ap Radial Depth
R 0.1	37,000	50	0.06	0.14
R 0.2	37,000	100	0.12	0.28
R 0.3	37,000	140	0.18	0.42
R 0.4	37,000	190	0.24	0.56
R 0.5	32,000	210	0.30	0.7
R 1	16,000	210	0.60	1.4
R 1.5	11,000	210	0.90	2.1
R 2	8,200	210	1.20	2.8
R 2.5	6,000	250	1.50	3.5
R 3	5,500	250	1.80	4.2
R 4	4,100	280	2.40	5.6
R 5	3,200	280	3.00	7.0
R 6	2,700	330	3.60	8.4
R 8	2,200	330	4.80	11.2

**절입량**  
Depth of Cut

- 유효장 길이가 긴 경우, RPM과 FEED를 동일 비율로 낮춰주세요.
- 상기 절삭조건은 참고 수치이므로 실 가공시 가공 형상, 가공 목적, 적용 기계에 따라 조건변경 요망 합니다.
- 적용 기계의 회전속도가 부족한 경우에는 회전 속도와 이송속도를 같은 비율로 줄여서 적용합니다.
- If the effective length is long, reduce the RPM and feed in the same proportion.
- Use this table for your reference. Adjust the parameters depending on your machining geometry, machining purpose and CNC.
- If the table over the maximum RPM and feed of your machine, adjust RPM and feed in the same proportion.

# 2MLE

• RPM : rev./min • Feed : mm/min

피삭재 Material	ABS 수지 / 아크릴 ABS resin / Acrylic			
외경 Outside Diameter	RPM	FEED	Ap Axial Depth	Ap Radial Depth
∅ 0.2	50,000	100	0.2	0.2
∅ 0.4	50,000	200	0.4	0.4
∅ 0.5	50,000	240	0.5	0.5
∅ 0.6	40,000	240	0.6	0.6
∅ 0.8	30,000	240	0.8	0.8
∅ 1	24,000	240	1	1
∅ 2	12,000	240	2	2
∅ 3	8,000	240	3	3
∅ 4	6,000	240	4	4
∅ 5	4,800	240	5	5
∅ 6	4,000	260	6	6
∅ 8	3,000	260	8	8
∅ 10	3,000	260	10	10
∅ 12	2,000	260	12	12
∅ 16	1,400	260	16	16

**절입량**  
Depth of Cut

- 날 끝이 정밀하게 연삭되어 있습니다. 파손을 피하기 위해 가능하면 비접촉 방식으로 측정하십시오.
- 유효장 길이가 긴 경우, RPM과 FEED를 동일 비율로 낮춰주세요.
- 상기 절삭조건은 참고 수치이므로 실 가공시 가공 형상, 가공 목적, 적용 기계에 따라 조건변경 요망 합니다.
- 적용 기계의 회전 속도가 부족한 경우에는 회전 속도와 이송속도를 같은 비율로 줄여서 적용합니다.
- The edge of the flute precisely grinded. If you want to measure the tool, and to avoid damaging on the flutes, use non-contact measuring method.
- If the effective length is long, reduce the RPM and feed in the same proportion.
- Use this table for your reference. Adjust the parameters depending on your machining geometry, machining purpose and CNC.
- If the table over the maximum RPM and feed of your machine, adjust RPM and feed in the same proportion.

# 2MBE / 3MBE

- 3MBE는 RPM과FEED를 10% Up 적용.
- Raise up the RPM and feed by 10% for 3MBE.

• RPM : rev./min • Feed : mm/min

피삭재 Material	일반구조강 / 쾌삭강 Mild steels / Free cutting steel HP/SM				구조용강 / 탄소강 / 회주철 Structural steel / Carbon Steels / Gray cast iron SS/SC/FC				공구강 / 금형강 Tool steels / Mold steels SCM/HPM			
	-200HB				~30HRc				30~ 40HRc			
경도 Hardness												
반경 Corner Radius	RPM	FEED	Ap Axial Depth	Ae Radial Depth	RPM	FEED	Ap Axial Depth	Ae Radial Depth	RPM	FEED	Ap Axial Depth	Ae Radial Depth
R 0.2	36,000	630	0.02	0.04	34,200	520	0.02	0.04	33,174	400	0.02	0.04
R 0.3	24,300	630	0.03	0.06	23,085	520	0.03	0.06	22,392	400	0.03	0.06
R 0.4	21,000	630	0.04	0.08	19,950	520	0.04	0.08	19,352	400	0.04	0.08
R 0.5	12,000	630	0.05	0.10	12,300	520	0.1	0.10	10,179	400	0.05	0.10
R 1	11,400	630	0.10	0.20	10,000	520	0.1	0.20	8,700	400	0.10	0.20
R 1.5	7,700	630	0.15	0.30	6,700	520	0.2	0.30	5,800	400	0.15	0.30
R 2	5,800	630	0.20	0.40	5,000	520	0.2	0.40	4,300	400	0.20	0.40
R 3	3,800	630	0.30	0.60	3,300	520	0.3	0.60	2,900	400	0.30	0.60
R 4	2,900	630	0.40	0.80	2,500	520	0.4	0.80	2,200	400	0.40	0.80
R 5	2,300	630	0.50	1.00	2,000	520	0.5	1.00	1,700	400	0.50	1.00
R 6	1,900	630	0.60	1.20	1,700	520	0.6	1.20	1,400	400	0.60	1.20

- 상기 절삭 조건은 2날 기준이며 3날 가공시 회전수와 Feed를 10% UP 시켜주십시오.
- R0.5 이하 제품은 절삭조건외 Feed 보다낮게 시작하여 점차 올려 주십시오.
- 상기 절삭조건은 참고 수치이므로 실 가공시 가공 형상, 가공 목적, 적용 기계에 따라 조건변경 요망 합니다.
- 적용 기계의 회전속도가 부족한 경우에는 회전 속도와 이송 속도를 같은 비율로 줄여서 적용합니다.
- The parameters on the table is based on 2 flutes. For using 3 flutes, increase RPM and feed by 10% in stable milling condition.
- Below 0.5mm of front diameter tool, set up the lower RPM
- Use this table for your reference. Adjust the parameters depending on your machining geometry, machining purpose and CNC.
- If the table over the maximum RPM and feed of your machine, adjust RPM and feed in the same proportion.

# 1MEM / 1REM

• RPM : rev./min • Feed : mm/min

피삭재 Material	ABS 수지 / 아크릴 ABS resin / Acrylic			구조용강 / 탄소강 / 회주철 Structural steel / Carbon Steels / Gray cast iron SS/SC/FC		
	외경 Outside Diameter	RPM	FEED	Ap (Axial Depth)	RPM	FEED
Ø 1	32,000	2,000	2.5	23,000	1,300	2.5
Ø 2	32,000	2,200	5	23,000	1,500	5
Ø 3	25,000	2,400	7.5	18,000	1,700	7.5
Ø 4	20,000	2,400	10	15,000	1,800	10
Ø 5	15,000	2,200	12.5	12,000	1,800	12.5
Ø 6	13,500	2,300	15	10,000	1,800	15
Ø 8	10,000	2,400	20	7,800	1,900	20
Ø 10	8,000	2,400	25	6,000	2,000	25
Ø 12	7,000	2,200	30	5,000	1,900	30

- 날 끝이 정밀하게 연삭되어 있습니다. 파손을 피하기 위해 가능하면 비접촉 방식으로 측정 하십시오
- 공구 진입시 피삭재 밖에서 진입 하십시오.
- 상기 절삭조건은 참고 수치이므로 실 가공시 가공 형상, 가공 목적, 적용 기계에 따라 조건변경 요망합니다.
- 조건표가 기계의 최대 스피들 속도를 초과하거나 버 및 적열 현상이 발생할 때 스피들 속도와 이송 속도를 비례하여 조정 하십시오.
- The edge of the flute precisely grinded. If you want to measure the tool, and to avoid damaging on the flutes, use non-contact measuring method.
- When entering the tool to the workpiece, enter the tool from outside to the workpiece.
- Use this table for your reference. Adjust the parameters depending on your machining geometry, machining purpose and CNC.
- If the table over the maximum RPM and feed of your machine, or found red heat on the material, adjust RPM and feed in the same proportion.

피삭재 Material		ABS / MC Nylon				Acrylic / Polyacetal				Polycarbonate			
외경 Outside Diameter	유효장 Effective Length	RPM	FEED	Ap Axial Depth	Ae Radial Depth	RPM	FEED	Ap Axial Depth	Ae Radial Depth	RPM	FEED	Ap Axial Depth	Ae Radial Depth
ø 0.5	2	7,800	150	0.20	0.005	19,500	150	0.20	0.005	11,700	150	0.20	0.005
"	4	7,800	150	0.20	0.003	19,500	150	0.20	0.003	11,700	150	0.20	0.003
"	6	7,800	150	0.20	0.001	19,500	150	0.20	0.001	11,700	150	0.20	0.001
ø 0.6	4	7,800	170	0.20	0.005	18,720	150	0.20	0.005	11,440	270	0.20	0.005
"	6	7,800	170	0.20	0.003	18,720	150	0.20	0.003	11,440	270	0.20	0.003
ø 0.7	4	7,800	190	0.20	0.01	17,940	150	0.20	0.01	11,180	390	0.20	0.01
"	6	7,800	190	0.20	0.008	17,940	150	0.20	0.008	11,180	390	0.20	0.008
ø 0.8	6	7,800	210	0.20	0.008	17,160	150	0.20	0.008	10,920	500	0.20	0.008
"	8	7,800	210	0.20	0.005	16,770	140	0.20	0.005	10,660	480	0.20	0.005
ø 0.9	6	7,800	230	0.20	0.08	16,380	150	0.20	0.08	10,660	650	0.20	0.08
"	10	7,800	230	0.20	0.03	15,340	130	0.20	0.03	10,140	500	0.20	0.03
ø 1	6	7,800	250	0.30	0.05	15,600	150	0.30	0.05	10,400	750	0.30	0.05
"	8	7,800	250	0.30	0.05	14,950	135	0.30	0.05	10,010	700	0.30	0.05
"	10	7,800	250	0.30	0.03	14,300	120	0.30	0.03	9,750	600	0.30	0.03
"	12	7,800	250	0.30	0.03	13,520	110	0.30	0.03	9,360	550	0.30	0.03
"	16	7,800	250	0.30	0.02	12,090	80	0.30	0.02	8,710	415	0.30	0.02
"	20	7,800	250	0.30	0.01	10,400	45	0.30	0.01	7,800	250	0.30	0.01
ø 1.2	6	7,800	305	0.40	0.05	15,210	165	0.40	0.05	10,400	750	0.40	0.05
"	8	7,800	305	0.40	0.05	14,560	150	0.40	0.05	10,010	700	0.40	0.05
"	10	7,800	300	0.40	0.03	13,910	140	0.40	0.03	9,750	650	0.40	0.03
"	12	7,800	300	0.40	0.03	13,260	125	0.40	0.03	9,360	600	0.40	0.03
ø 1.4	6	7,800	360	0.40	0.05	14,742	180	0.40	0.05	10,400	800	0.40	0.05
"	10	7,800	350	0.40	0.03	13,910	155	0.40	0.03	10,010	700	0.40	0.03
"	16	7,800	340	0.40	0.01	12,740	115	0.40	0.01	9,360	500	0.40	0.01
ø 1.5	6	7,930	390	0.50	0.05	14,560	190	0.50	0.05	10,400	800	0.50	0.05
"	10	7,800	380	0.50	0.05	13,260	165	0.50	0.05	9,750	700	0.50	0.05
"	14	7,800	365	0.50	0.03	12,480	135	0.50	0.03	9,100	550	0.50	0.03
"	16	7,800	365	0.50	0.03	11,440	125	0.50	0.03	8,710	500	0.50	0.03
"	20	7,670	350	0.50	0.02	9,880	90	0.50	0.02	7,930	375	0.50	0.02
ø 1.6	6	7,930	415	0.80	0.05	14,300	195	0.80	0.05	10,400	800	0.80	0.05
ø 2	8	7,930	500	1.00	0.10	13,130	220	1.00	0.10	10,270	850	1.00	0.10
"	10	7,800	490	1.00	0.10	12,740	210	1.00	0.10	10,010	800	1.00	0.10
"	12	7,800	485	1.00	0.08	12,350	200	1.00	0.08	9,750	800	1.00	0.08
"	14	7,670	475	1.00	0.08	11,830	190	1.00	0.08	9,490	750	1.00	0.08
"	16	7,670	465	1.00	0.05	11,440	180	1.00	0.05	9,230	700	1.00	0.05
"	18	7,540	460	1.00	0.05	11,050	170	1.00	0.05	8,970	650	1.00	0.05
"	20	7,410	445	1.00	0.03	10,400	150	1.00	0.03	8,450	600	1.00	0.03
"	25	7,280	425	1.00	0.03	9,360	125	1.00	0.03	7,800	550	1.00	0.03
"	30	7,020	400	1.00	0.02	8,060	95	1.00	0.02	7,020	425	1.00	0.02
ø 2.5	12	7,800	650	1.20	0.20	11,180	240	1.20	0.20	9,620	800	1.20	0.20
"	20	7,410	550	1.00	0.10	8,840	175	1.00	0.10	8,060	650	1.00	0.10
ø 3	8	8,060	800	1.50	0.30	11,310	305	1.50	0.30	10,400	950	1.50	0.30
"	12	7,800	750	1.50	0.25	10,400	280	1.50	0.25	9,750	900	1.50	0.25
"	16	7,540	700	1.50	0.20	9,490	255	1.50	0.20	9,100	850	1.50	0.20
"	20	7,280	650	1.50	0.20	8,320	220	1.50	0.20	8,190	900	1.50	0.20
"	25	7,020	600	1.50	0.15	7,150	185	1.50	0.15	7,280	700	1.50	0.15
"	30	6,760	550	1.50	0.10	5,850	145	1.50	0.10	6,240	600	1.50	0.10
"	40	6,240	480	1.50	0.10	3,510	80	1.50	0.10	4,550	420	1.50	0.10
ø 4	12	6,500	700	2.00	0.35	9,100	260	2.00	0.35	7,540	750	2.00	0.35
"	16	6,370	700	2.00	0.30	8,450	240	2.00	0.30	7,150	700	2.00	0.30
"	18	6,240	700	2.00	0.30	8,190	235	2.00	0.30	7,020	700	2.00	0.30
"	20	6,240	700	2.00	0.30	7,800	220	2.00	0.30	6,630	650	2.00	0.30
"	25	6,110	650	2.00	0.25	7,280	205	2.00	0.25	6,670	650	2.00	0.25
"	30	5,850	650	2.00	0.20	6,110	170	2.00	0.20	5,720	550	2.00	0.20
"	35	5,590	650	2.00	0.20	5,460	150	2.00	0.20	5,330	550	2.00	0.20
"	40	5,460	650	2.00	0.10	4,680	125	2.00	0.10	4,680	480	2.00	0.10
"	50	5,070	600	2.00	0.10	3,120	80	2.00	0.10	3,770	390	2.00	0.10
ø 5	16	4,420	600	2.50	0.50	7,540	235	2.50	0.50	5,200	600	2.50	0.50
"	35	4,160	550	2.50	0.30	5,070	130	2.50	0.30	3,770	455	2.50	0.30
ø 6	35	3,120	480	3.00	0.40	3,380	120	3.00	0.40	2,470	380	3.00	0.40
"	50	2,860	445	3.00	0.30	2,470	85	3.00	0.30	2,210	335	3.00	0.30
"	60	2,600	400	3.00	0.20	13,00	45	3.00	0.20	1,950	300	3.00	0.20

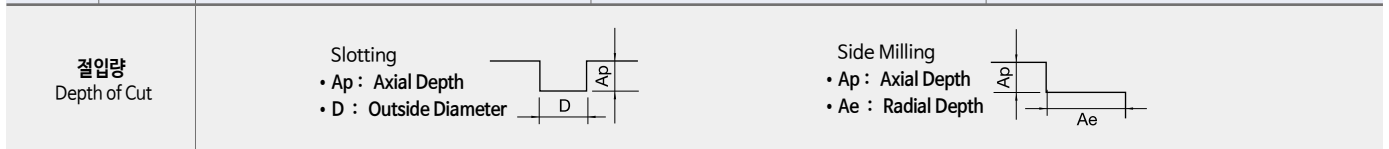

피삭재 Material		ABS / MC Nylon				Acrylic / Polyacetal				Polycarbonate			
외경 Outside Diameter	유효장 Effective Length	RPM	FEED	Ap Axial Depth	Ae Radial Depth	RPM	FEED	Ap Axial Depth	Ae Radial Depth	RPM	FEED	Ap Axial Depth	Ae Radial Depth
∅ 1	10	8,268	280	0.30	0.03	14,056	132	0.30	0.03	10,725	784	0.30	0.03
"	15	8,268	280	0.30	0.02	12,126	86	0.30	0.02	9,568	560	0.30	0.02
"	20	8,268	280	0.30	0.01	10,473	52	0.30	0.01	8,775	420	0.30	0.01
∅ 1.5	10	8,268	426	0.50	0.05	14,056	185	0.50	0.05	10,335	784	0.50	0.05
"	15	8,268	409	0.50	0.03	12,126	140	0.50	0.03	9,233	560	0.50	0.03
"	20	8,130	392	0.50	0.02	10,473	101	0.50	0.02	8,406	420	0.50	0.02
∅ 2	10	8,229	550	1.00	0.10	13,441	236	1.00	0.10	10,561	898	1.00	0.10
"	15	8,092	522	1.00	0.05	12,069	202	1.00	0.05	9,738	785	1.00	0.05
"	20	7,818	499	1.00	0.03	10,972	168	1.00	0.03	8,915	673	1.00	0.03
"	25	7,680	477	1.00	0.03	9,875	140	1.00	0.03	8,229	617	1.00	0.03
∅ 3	20	7,622	733	1.50	0.20	8,711	248	1.50	0.20	8,575	1,015	1.50	0.20
"	30	7,078	620	1.50	0.10	6,125	164	1.50	0.10	6,533	677	1.50	0.10
∅ 4	20	6,533	790	2.00	0.30	8,167	248	2.00	0.30	6,942	733	2.00	0.30
"	30	6,125	733	2.00	0.20	6,397	192	2.00	0.20	5,989	620	2.00	0.20
∅ 6	30	4,141	612	3.00	0.40	4,486	153	3.00	0.40	3,279	484	3.00	0.40
"	40	3,629	547	3.00	0.30	3,134	104	3.00	0.30	2,804	412	3.00	0.30
∅ 8	40	3,338	514	4.00	0.50	2,883	98	4.00	0.50	2,580	387	4.00	0.50
"	50	2,571	432	4.00	0.40	2,220	82	4.00	0.40	1,986	325	4.00	0.40
∅ 10	50	2,262	401	5.00	0.60	1,954	77	5.00	0.60	1,748	302	5.00	0.60
"	60	1,697	169	5.00	0.50	1,465	32	5.00	0.50	1,311	127	5.00	0.50
∅ 12	60	1,442	153	6.00	0.60	1,245	29	6.00	0.60	1,114	116	6.00	0.60

<p><b>절입량</b> Depth of Cut</p>	<p><b>Slotting</b></p> <ul style="list-style-type: none"> <li>• Ap : Axial Depth</li> <li>• D : Outside Diameter</li> </ul> 	<p><b>Side Milling</b></p> <ul style="list-style-type: none"> <li>• Ap : Axial Depth</li> <li>• Ae : Radial Depth</li> </ul> 
------------------------------------	---	--

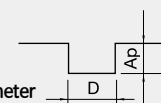
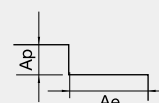
- 날 끝이 정밀하게 연삭되어 있습니다. 파손을 피하기 위해 가능하면 비접촉 방식으로 측정 하십시오
- 가공 진입시 가능한 피삭재 밖에서 진입 하십시오.
- 상기 절삭조건은 참고 수치이므로 실 가공시 가공 형상, 가공 목적, 적용 기계에 따라 조건변경 요망합니다.
- 조건표가 기계의 최대 스피들 속도를 초과하거나 버 및 적열 현상이 발생할 때 스피들 속도와 이송 속도를 비례하여 조정 하십시오.
- 진동이 적고 강성이 좋은 공작기계 사용 요망합니다 (∅1 이하 사용시 진동 허용 관리 5 $\mu$ m 이내 일것.)

- The edge of the flute precisely grinded. If you want to measure the tool, and to avoid damaging on the flutes, use non-contact measuring method.
- When entering the tool to the workpiece, enter the tool from outside to the workpiece.
- Use this table for your reference. Adjust the parameters depending on your machining geometry, machining purpose and CNC.
- If the table over the maximum RPM and feed of your machine, or found red heat on the material, adjust RPM and feed in the same proportion.
- Use a machine with low vibration and good rigidity ( $\varnothing 1$  or less, the vibration tolerance management should be within 5 $\mu$ m).

# 2MEM

• RPM : rev./min • Feed : mm/min

피삭재 Material	일반구조강 / 쾌삭강 Mild steels / Free cutting steel HP / SM				구조용강 / 탄소강 / 회주철 Structural steel / Carbon Steels / Gray cast iron SS / SC / FC				알루미늄 합금 Aluminum alloys AL7075			
	~200HB				~30HRc							
경도 Hardness												
외경 Outside Diameter	RPM	FEED	Ap Axial Depth	Ae Radial Depth	RPM	FEED	Ap Axial Depth	Ae Radial Depth	RPM	FEED	Ap Axial Depth	Ae Radial Depth
ø 1	12,900	125	0.15	0.07	11,400	90	0.15	0.07	43,000	510	0.15	0.07
ø 1.5	8,600	125	0.75	0.11	7,700	90	0.75	0.11	29,000	580	0.75	0.11
ø 2	6,500	125	1.00	0.14	5,800	110	1.00	0.14	22,000	650	1.00	0.14
ø 2.5	5,100	150	1.25	0.18	4,600	110	1.25	0.18	17,200	680	1.25	0.18
ø 3	4,300	170	1.50	0.45	3,800	120	1.50	0.45	14,300	720	1.50	0.45
ø 4	3,200	200	3.00	0.60	2,900	120	3.00	0.60	10,700	750	3.00	0.60
ø 5	2,600	210	3.75	0.75	2,300	135	3.75	0.75	8,600	775	3.75	0.75
ø 6	2,200	220	4.50	0.90	1,900	150	4.50	0.90	7,200	790	4.50	0.90
ø 8	1,600	200	6.00	1.20	1,400	145	6.00	1.20	5,400	700	6.00	1.20
ø 10	1,300	180	7.50	1.50	1,200	145	7.50	1.50	4,300	650	7.50	1.50
ø 12	1,100	170	9.00	1.80	1,000	135	9.00	1.80	3,600	610	9.00	1.80

# 3MEM

• RPM : rev./min • Feed : mm/min

피삭재 Material	일반구조강 / 쾌삭강 Mild steels / Free cutting steel HP / SM				구조용강 / 탄소강 / 회주철 Structural steel / Carbon Steels / Gray cast iron SS / SC / FC				알루미늄 합금 Aluminum alloys AL7075			
	~200HB				~30HRc							
경도 Hardness												
외경 Outside Diameter	RPM	FEED	Ap Axial Depth	Ae Radial Depth	RPM	FEED	Ap Axial Depth	Ae Radial Depth	RPM	FEED	Ap Axial Depth	Ae Radial Depth
ø 1	13,674	141	0.15	0.07	12,084	101	0.15	0.07	45,580	566	0.15	0.07
ø 1.5	9,116	141	0.75	0.11	8,162	101	0.75	0.11	30,740	644	0.75	0.11
ø 2	6,890	141	1.00	0.14	6,148	123	1.00	0.14	23,320	722	1.00	0.14
ø 2.5	5,406	170	1.25	0.18	4,876	123	1.25	0.18	18,232	769	1.25	0.18
ø 3	4,558	192	1.50	0.45	4,028	134	1.50	0.45	15,158	799	1.50	0.45
ø 4	3,392	226	3.00	0.60	3,074	134	3.00	0.60	11,342	833	3.00	0.60
ø 6	2,332	249	4.50	0.90	2,014	168	4.50	0.90	7,632	877	4.50	0.90

# 4MEM

• RPM : rev./min • Feed : mm/min

피삭재 Material	일반구조강 / 쾌삭강 Mild steels / Free cutting steel HP / SM				구조용강 / 탄소강 / 회주철 Structural steel / Carbon Steels / Gray cast iron SS / SC / FC				알루미늄 합금 Aluminum alloys AL7075			
	~200HB				~30HRc							
경도 Hardness												
외경 Outside Diameter	RPM	FEED	Ap Axial Depth	Ae Radial Depth	RPM	FEED	Ap Axial Depth	Ae Radial Depth	RPM	FEED	Ap Axial Depth	Ae Radial Depth
ø 1	14,084	153	0.15	1.00	12,483	107	0.15	1.00	46,583	594	0.15	1.00
ø 1.5	9,389	153	0.75	1.50	8,431	107	0.75	1.50	31,416	676	0.75	1.50
ø 2	7,097	153	1.00	2.00	6,351	131	1.00	2.00	23,833	758	1.00	2.00
ø 2.5	5,568	183	1.25	2.50	5,037	131	1.25	2.50	18,633	808	1.25	2.50
ø 3	4,695	207	1.50	3.00	4,161	142	1.50	3.00	15,491	839	1.50	3.00
ø 4	3,494	244	3.00	4.00	3,175	142	3.00	4.00	11,592	874	3.00	4.00
ø 6	2,402	268	4.50	6.00	2,080	178	4.50	6.00	7,800	921	4.50	6.00
ø 8	2,509	258	6.00	8.00	1,957	156	6.00	8.00	6,006	889	6.00	8.00
ø 10	1,720	234	7.50	10.00	1,342	133	7.50	10.00	4,625	826	7.50	10.00
ø 12	1,279	210	9.00	12.00	998	116	9.00	12.00	3,561	744	9.00	12.00

**절입량**  
Depth of Cut

$Ae \sim 2.9 = 0.07D$   
 $\varnothing 1 \sim 2.9 = 0.07D$   
 $\varnothing 3 \sim 0.15D$

$Ap \sim 1.2 = 0.15D$   
 $\varnothing 1.5 \sim 3.5 = 0.5D$   
 $\varnothing 4 \sim 0.75D$

- 날 끝이 정밀하게 연삭되어 있습니다. 파손을 피하기 위해 가능하면 비접촉 방식으로 측정 하십시오.
- 공구 진입시 피삭재 밖에서 진입 하십시오.
- 상기 절삭조건은 참고 수치이므로 실 가공시 가공 형상, 가공 목적, 적용 기계에 따라 조건변경 요망합니다.
- 조건표가 기계의 최대 스피들 속도를 초과하거나 버 및 적열 현상이 발생할 때 스피들 속도와 이송 속도를 비례하여 조정 하십시오.
- The edge of the flute precisely grinded. If you want to measure the tool, and to avoid damaging on the flutes, use non-contact measuring method.
- When entering the tool to the workpiece, enter the tool from outside to the workpiece.
- Use this table for your reference. Adjust the parameters depending on your machining geometry, machining purpose and CNC.
- If the table over the maximum RPM and feed of your machine, or found red heat on the material, adjust RPM and feed in the same proportion.

# 2HHINB/2JJINB Cutting Condition

• RPM : rev./min • Feed : mm/min

피삭재 Material	공구강 / 금형강 Tool steels / Mold steels SCM / HPM 30 ~40HRC				합금강 / 프리하든강 Alloy Steels / Pre-hardened Steels NAK80 / KP4M 40~45HRC				고경도강 Hardened Steels STAVAX / SKD11			
	경도 Hardness 30 ~ 40Hrc				40 ~ 45Hrc				45 ~ 55Hrc			
반경 Corner Radius	RPM	FEED	Ap	Ae	RPM	FEED	Ap	Ae	RPM	FEED	Ap	Ae
			Axial Depth	Radial Depth			Axial Depth	Radial Depth			Axial Depth	Radial Depth
R 5	7320	2635	0.25	1.0	6700	2196	0.50	1.0	5400	1910	0.50	0.50
R 5.5	6660	2428	0.28	1.1	6000	2024	0.55	1.1	4900	1760	0.55	0.55
R 6	6100	2185	0.30	1.2	5570	1821	0.60	1.2	4500	1584	0.60	0.60
R 6.5	5630	2015	0.33	1.3	5150	1679	0.65	1.3	4160	1461	0.65	0.65
R 8	4580	1639	0.40	1.6	4180	1366	0.80	1.6	3380	1188	0.80	0.80
R 8.5	4300	1542	0.43	1.7	3900	1285	0.85	1.7	3180	1118	0.85	0.85
R 10	3660	1311	0.50	2.0	3340	1093	1.00	2.0	2700	950	1.00	1.00
R 10.5	3500	1250	0.53	2.1	3180	1042	1.05	2.1	2580	906	1.05	1.05
R 12.5	2930	1056	0.63	2.5	2670	880	1.25	2.5	2170	765	1.25	1.25
R 13	2800	1007	0.65	2.6	2600	839	1.30	2.6	2080	730	1.30	1.30
R 15	2440	874	0.75	3.0	2230	728	1.50	3.0	1800	633	1.50	1.50

**절입량**  
Depth of Cut

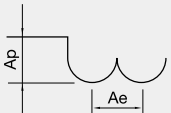

Ap : Axial Depth 축방향의절입깊이(mm)  
 Ae : Radial Depth 반경방향의절입깊이(mm)  
 D : Outside Diameter 외경(mm)  
 n : Speed 회전속도 (min<sup>-1</sup>)  
 Vf : Feed 이송속도 (mm/min)

- 유효장 길이가 긴 경우에는 회전수와 이송속도를 최대 20% 이하로 줄이십시오.
- 인서트 체결 및 볼트의 조임을 확인 후 가공하십시오.
- 상기 절삭조건은 참고 수치이므로 실 가공시 가공 형상, 가공 목적, 적용 기계에 따라 조건변경 요망 합니다.
- 공작기계와 가공물의 강성이 없는 경우 진동이 발생할시 조건표에 회전속도와 이송속도를 같은 비율로 줄여서 적용 합니다.
- 에어브로, 절삭유, 오일 미스트 쿨런트를 추천하며, 칩을 잘 제거하고 가공시 발열과 발화에 주의 하십시오
- In case of long effective length, reduce the RPM and feed by 20% or less.
- After the heat the shrink-fit, check the clamping and bolt status, and then use.
- Use this table for your reference. Adjust the parameters depending on your machining geometry, machining purpose and CNC.
- In case of workpiece and machine do not have enough rigidity and make vibration, reduce the RPM and feed in same proportion.
- Air blow or mist coolants are recommended and note for chip emission, heat, or ignition.

# 2HHINC/2JJINC Cutting Condition

• RPM : rev./min • Feed : mm/min

피삭재 Material	공구강 / 금형강 Tool steels / Mold steels SCM / HPM 30 ~40HRC				합금강 / 프리하든강 Alloy Steels / Pre-hardened Steels NAK80 / KP4M 40~45HRC				고경도강 Hardened Steels STAVAX / SKD11			
	경도 Hardness 30 ~ 40Hrc				40 ~ 45Hrc				45 ~ 55Hrc			
외경 Outside Diameter	RPM	FEED	Ap	Ae	RPM	FEED	Ap	Ae	RPM	FEED	Ap	Ae
			Axial Depth	Radial Depth			Axial Depth	Radial Depth			Axial Depth	Radial Depth
ø 10	9550	950	0.25	2.0	8900	890	0.50	2.0	7000	700	0.50	1.0
ø 11	8690	870	0.28	2.2	8100	810	0.55	2.2	6370	640	0.55	1.1
ø 12	7960	800	0.30	2.4	7430	740	0.60	2.4	5840	580	0.60	1.2
ø 13	7350	730	0.33	2.6	6860	690	0.65	2.6	5390	540	0.65	1.3
ø 16	5970	600	0.40	3.2	5570	550	0.80	3.2	4380	440	0.80	1.6
ø 17	5620	560	0.43	3.4	5240	520	0.85	3.4	4120	410	0.85	1.7
ø 20	4780	480	0.50	4.0	4460	450	1.00	4.0	3500	350	1.00	2.0
ø 21	4550	450	0.53	4.2	4250	425	1.05	4.2	3340	330	1.05	2.1
ø 25	3800	380	0.63	5.0	3670	350	1.25	5.0	2800	280	1.25	2.5
ø 26	3670	360	0.65	5.2	3400	340	1.30	5.2	2700	270	1.30	2.6
ø 30	3200	320	0.75	6.0	2980	290	1.50	6.0	2330	230	1.50	3.0

**절입량**  
Depth of Cut

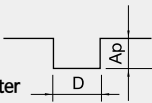

Slotting  
 • Ap : Axial Depth  
 • D : Outside Diameter

- 유효장 길이가 긴 경우, RPM과 FEED를 동일 비율로 낮춰주세요.
- 인서트 체결 및 볼트의 조임을 확인 후 가공 하십시오.
- 상기 절삭조건은 참고 수치이므로 실 가공시 가공 형상, 가공 목적, 적용 기계에 따라 조건변경 요망 합니다.
- 조건표가 기계의 최대 스피들 속도를 초과하거나 버 및 적열 현상이 발생할 때 스피들 속도와 이송 속도를 비례하여 조정하십시오.
- 에어브로, 절삭유, 오일 미스트 쿨런트를 추천하며, 칩을 잘 제거하고 가공시 발열과 발화에 주의 하십시오
- If the effective length is long, reduce the RPM and feed in the same proportion.
- After the heat the shrink-fit, check the clamping and bolt status, and then use.
- Use this table for your reference. Adjust the parameters depending on your machining geometry, machining purpose and CNC.
- If the table over the maximum RPM and feed of your machine, or found red heat on the material, adjust RPM and feed in the same proportion.
- Air blow or mist coolants are recommended and note for chip emission, heat, or ignition.



# 2GINB Cutting Condition

• RPM : rev./min • Feed : mm/min

피삭재 Material	공구강 / 금형강 Tool steels / Mold steels SCM / HPM				합금강 / 프리하든강 Alloy Steels / Pre-hardened Steels NAK80 / KP4M				고경도강 Hardened Steels STAVAX / SKD11			
	30 ~ 40Hrc				40 ~ 45Hrc				45 ~ 55Hrc			
경도 Hardness	RPM	FEED	Ap Axial Depth	Ae Radial Depth	RPM	FEED	Ap Axial Depth	Ae Radial Depth	RPM	FEED	Ap Axial Depth	Ae Radial Depth
R 5	6,220	2,500	0.1	0.5	5,700	1,700	0.1	0.3	4,590	1,840	0.05	0.3
R 5.5	5,660	2,260	0.1	0.5	5,100	1,530	0.1	0.3	4,160	1,700	0.06	0.3
R 6	5,180	2,070	0.1	0.5	4,740	1,420	0.1	0.3	3,800	1,530	0.06	0.3
R 6.5	4,800	1,900	0.1	0.5	4,380	1,320	0.1	0.3	3,530	1,400	0.07	0.3
R 8	3,900	1,530	0.2	0.5	3,550	1,060	0.1	0.3	2,870	1,150	0.08	0.3
R 8.5	3,660	1,460	0.2	0.5	3,300	1,000	0.1	0.3	2,700	1,080	0.09	0.3
R 10	3,120	1,240	0.2	0.5	2,840	850	0.1	0.3	2,300	920	0.10	0.3
R 10.5	3,000	1,180	0.2	0.5	2,700	800	0.1	0.3	2,200	880	0.11	0.3
R 12.5	2,500	990	0.3	0.5	2,270	680	0.1	0.3	1,830	740	0.13	0.3
R 13	2,380	960	0.3	0.5	2,210	650	0.1	0.3	1,760	700	0.13	0.3
R 15	2,080	850	0.3	0.5	1,990	600	0.2	0.3	1,530	610	0.15	0.3

**절입량**  
Depth of Cut

Ap : Axial Depth 축방향의절입깊이(mm)  
 Ae : Radial Depth 반경방향의절입깊이(mm)  
 D : Outside Diameter 외경(mm)  
 n : Speed 회전속도 (min<sup>-1</sup>)  
 Vf : Feed 이송속도 (mm/min)

- 유효장이 긴 경우에는 회전수와 이송속도를 최대 20% 이하로 줄이십시오.
- 인서트 체결 및 볼트의 조임을 확인 후 가공하십시오.
- 상기 절삭조건은 참고 수치이므로, 실 가공시 가공 형상, 가공 목적, 적용 기계에 따라 조건변경 요망 합니다.
- 공작기계와 가공물의 강성이 없는 경우 진동이 발생할시 조건표에 회전속도와 이송속도를 같은 비율로 줄여서 적용 합니다.
- 에어브로, 절삭유, 오일 미스트 쿨런트를 추천하며, 칩을 잘 제거하고 가공시 발열과 발화에 주의 하십시오
- In case of long effective length, reduce the RPM and feed by 20% or less.
- After the heat the shrink-fit, check the clamping and bolt status, and then use.
- Use this table for your reference. Adjust the parameters depending on your machining geometry, machining purpose and CNC.
- In case of workpiece and machine do not have enough rigidity and make vibration, reduce the RPM and feed in same proportion.
- Air blow or mist coolants are recommended and note for chip emission, heat, or ignition.

# 2GINC Cutting Condition

• RPM : rev./min • Feed : mm/min

피삭재 Material	공구강 / 금형강 Tool steels / Mold steels SCM / HPM				합금강 / 프리하든강 Alloy Steels / Pre-hardened Steels NAK80 / KP4M				고경도강 Hardened Steels STAVAX / SKD11			
	30 ~ 40Hrc				40 ~ 45Hrc				45 ~ 55Hrc			
외경 Outside Diameter	RPM	FEED	Ap Axial Depth	Ae Radial Depth	RPM	FEED	Ap Axial Depth	Ae Radial Depth	RPM	FEED	Ap Axial Depth	Ae Radial Depth
Ø 10	8,200	807	0.3	2.0	7,560	756	0.1	1.0	5,950	595	0.125	1.0
Ø 11	7,400	739	0.3	2.2	6,900	688	0.1	1.1	5,410	544	0.138	1.1
Ø 12	6,770	680	0.3	2.4	6,320	629	0.2	1.2	4,960	493	0.150	1.2
Ø 13	6,250	620	0.3	2.6	5,830	586	0.2	1.3	4,580	459	0.163	1.3
Ø 16	5,070	510	0.4	3.2	4,740	467	0.2	1.6	3,720	374	0.200	1.6
Ø 17	4,780	476	0.4	3.4	4,450	442	0.2	1.7	3,500	348	0.213	1.7
Ø 20	4,060	408	0.5	4.0	3,790	382	0.3	2.0	2,970	297	0.250	2.0
Ø 21	3,870	382	0.5	4.2	3,610	361	0.3	2.1	2,840	280	0.263	2.1
Ø 25	3,230	323	0.6	5.0	3,120	287	0.3	2.5	2,380	238	0.313	2.5
Ø 26	3,120	306	0.7	5.2	2,890	289	0.3	2.6	2,300	229	0.325	2.6
Ø 30	2,720	272	0.8	6.0	2,530	246	0.4	3.0	1,980	195	0.375	3.0

**절입량**  
Depth of Cut

Slotting  
 • Ap : Axial Depth  
 • D : Outside Diameter

- 유효장 길이가 긴 경우, RPM과 FEED를 동일 비율로 낮춰주세요.
- 인서트 체결 및 볼트의 조임을 확인 후 가공 하십시오.
- 상기 절삭조건은 참고 수치이므로, 실 가공시 가공 형상, 가공 목적, 적용 기계에 따라 조건변경 요망 합니다.
- 조건표가 기계의 최대 스피드 속도를 초과하거나 버 및 적열 현상이 발생 시 스피드 속도와 이송 속도를 비례하여 조정하십시오.
- 에어브로, 절삭유, 오일 미스트 쿨런트를 추천하며, 칩을 잘 제거하고 가공시 발열과 발화에 주의 하십시오
- If the effective length is long, reduce the RPM and feed in the same proportion.
- After the heat the shrink-fit, check the clamping and bolt status, and then use.
- Use this table for your reference. Adjust the parameters depending on your machining geometry, machining purpose and CNC.
- If the table over the maximum RPM and feed of your machine, or found red heat on the material, adjust RPM and feed in the same proportion.
- Air blow or mist coolants are recommended and note for chip emission, heat, or ignition.

피삭재 Material	흑연 Graphite			
반경 Radius	RPM	FEED	Ap Axial Depth	Ae Radial Depth
R 5	12740	4200	0.250	1.0
R 5.5	11580	3892	0.275	1.1
R 6	10600	3570	0.300	1.2
R 6.5	9800	3290	0.325	1.3
R 8	7960	3800	0.400	1.6
R 8.5	7490	3600	0.850	1.7
R 10	6370	3060	1.000	2.0
R 10.5	6000	2900	1.050	2.1
R 12.5	5100	2440	1.250	2.5
R 13	4900	2360	1.300	2.6
R 15	4250	2000	1.500	3.0

절입량 Depth of Cut		Ap : Axial Depth
		Ae : Radial Depth
		D : Outside Diameter
		n : Speed (min <sup>-1</sup> )
		Vf : Feed (mm/min)

피삭재 Material	흑연 Graphite			
외경 Outside Diameter	RPM	FEED	Ap Axial Depth	Ae Radial Depth
∅ 10	16560	2822	0.250	3.0
∅ 11	15000	1862	0.275	3.3
∅ 12	13780	1708	0.300	3.6
∅ 13	12740	1582	0.325	3.9
∅ 16	10350	1820	0.400	4.8
∅ 17	9740	1720	0.850	5.1
∅ 20	8280	1460	1.000	6.0
∅ 21	7800	1400	1.050	6.3
∅ 25	6630	1180	1.250	7.5
∅ 26	6370	1140	1.300	7.8
∅ 30	5520	1920	1.500	9.0

절입량 Depth of Cut		Slotting
		• Ap : Axial Depth
		• D : Outside Diameter

- 유효장 길이가 긴 경우, RPM과 FEED를 동일 비율로 낮춰주세요.
- 인서트 체결 및 볼트의 조임을 확인 후 가공 하십시오.
- 상기 절삭조건은 참고 수치이므로 실 가공시 가공 형상, 가공 목적, 적용 기계에 따라 조건변경 요망 합니다.
- 조건표가 기계의 최대 스피들 속도를 초과하거나 버 및 적열 현상이 발생 시 스피들 속도와 이송 속도를 비례하여 조정하십시오.
- 흑연 가공 에어브로를 추천합니다.
- If the effective length is long, reduce the RPM and feed in the same proportion.
- After the heat the shrink-fit, check the clamping and bolt status, and then use.
- Use this table for your reference. Adjust the parameters depending on your machining geometry, machining purpose and CNC.
- If the table over the maximum RPM and feed of your machine, or found red heat on the material, adjust RPM and feed in the same proportion.
- Air blow is recommended for graphite milling.

## 4SFJB Cutting Condition

피삭재 Material	공구강 / 금형강 Tool steels / Mold steels SCM / HPM				합금강 / 프리하든강 Alloy Steels / Pre-hardened Steels NAK80 / KP4M				고경도강 Hardened Steels STAVAX / SKD11			
경도 Hardness	30 ~ 40Hrc				40 ~ 45Hrc				45 ~ 55Hrc			
반경 Corner Radius	RPM	FEED	Ap Axial Depth	Ae Radial Depth	RPM	FEED	Ap Axial Depth	Ae Radial Depth	RPM	FEED	Ap Axial Depth	Ae Radial Depth
R 5	6370	2380	0.3	1.0	4750	1700	0.13	0.8	3100	620	0.13	0.8
R 5.5	5800	2125	0.3	1.1	4300	1550	0.14	0.8	2840	570	0.14	0.8
R 6	5300	1980	0.3	1.2	3950	1420	0.15	0.9	2600	520	0.15	0.9
R 6.5	4900	1836	0.3	1.3	3650	1300	0.16	1.0	2400	480	0.16	1.0
R 8	4000	1487	0.5	1.8	3000	1070	0.23	1.4	1950	390	0.23	1.4
R 8.5	3750	1402	0.5	1.9	2800	1000	0.24	1.4	1800	370	0.24	1.4
R 10	3180	1190	0.5	2.0	2370	850	0.25	1.5	1560	300	0.25	1.5
R 10.5	3000	1130	0.5	2.1	2260	800	0.26	1.6	1500	300	0.26	1.6

절입량 Depth of Cut		Ap : Axial Depth 축방향의절입깊이(mm)
		Ae : Radial Depth 반경방향의절입깊이(mm)
		D : Outside Diameter 외경(mm)
		n : Speed 회전속도 (min <sup>-1</sup> )
		Vf : Feed 이송속도 (mm/min)

- 유효장이 긴 경우에는 회전수와 이송속도를 최대 20% 이하로 줄이십시오.
- 열박음 후 완전히 밀착되었는지 확인 후 가공 하십시오.
- 상기 절삭조건은 참고 수치이므로 실 가공시 가공 형상, 가공 목적, 적용 기계에 따라 조건변경 요망 합니다.
- 공작기계와 가공물의 강성이 없는 경우 진동이 발생할시 조건표에 회전속도와 이송속도를 같은 비율로 줄여서 적용 합니다.
- 에어브로, 절삭유, 오일 미스트 콜러트를 추천하며, 칩을 잘 제거하고 가공시 발열과 발화에 주의 하십시오
- In case of long effective length, reduce the RPM and feed by 20% or less.
- After the heat the shrink-fit, check the clamping and bolt status, and then use.
- Use this table for your reference. Adjust the parameters depending on your machining geometry, machining purpose and CNC.
- In case of workpiece and machine do not have enough rigidity and make vibration, reduce the RPM and feed in same proportion.
- Air blow or mist coolants are recommended and note for chip emission, heat, or ignition.

## 홈절삭 Slotting

피삭재 Material	공구강 / 금형강 Tool steels / Mold steels SCM / HPM				합금강 / 프리하든강 Alloy Steels / Pre-hardened Steels NAK80 / KP4M				고경도강 Hardened Steels STAVAX / SKD11			
	30 ~ 40HRc				40 ~ 45HRc				45 ~ 55HRc			
경도 Hardness												
외경 Outside Diameter	RPM	FEED	Ap Axial Depth	Ae Axial Depth	RPM	FEED	Ap Axial Depth	Ae Axial Depth	RPM	FEED	Ap Axial Depth	Ae Axial Depth
∅ 10	1600	320	2.0	10	1440	288	1.0	10	800	130	1.0	8.0
∅ 11	1450	290	2.2	11	1305	261	1.1	11	725	120	1.1	8.8
∅ 12	1330	265	2.4	12	1197	239	1.2	12	660	100	1.2	9.6
∅ 13	1225	245	2.6	13	1103	221	1.3	13	610	100	1.3	10.4
∅ 16	1000	200	3.2	16	900	180	1.6	16	500	80	1.6	12.8
∅ 17	940	190	3.4	17	846	171	1.7	17	470	75	1.7	13.6
∅ 20	800	160	4.0	20	720	144	2.0	20	400	65	2.0	16.0
∅ 21	760	150	4.2	21	684	135	2.1	21	380	60	2.1	16.8

절입량  
Depth of Cut

Slotting

• Ap : Axial Depth

• D : Outside Diameter

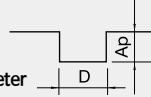

## 측면절삭 Side Cutting

피삭재 Material	공구강 / 금형강 Tool steels / Mold steels SCM / HPM				합금강 / 프리하든강 Alloy Steels / Pre-hardened Steels NAK80 / KP4M				고경도강 Hardened Steels STAVAX / SKD11			
	30 ~ 40HRc				40 ~ 45HRc				45 ~ 55HRc			
경도 Hardness												
외경 Outside Diameter	RPM	FEED	Ap Axial Depth	Ae Radial Depth	RPM	FEED	Ap Axial Depth	Ae Radial Depth	RPM	FEED	Ap Axial Depth	Ae Radial Depth
∅ 10	2050	500	5.0	1.0	2050	480	5.0	0.5	800	130	3.0	0.5
∅ 11	1880	450	5.5	1.1	1880	420	5.5	0.6	730	120	3.3	0.6
∅ 12	1720	410	6.0	1.2	1720	380	6.0	0.6	660	100	3.6	0.6
∅ 13	1600	380	6.5	1.3	1600	350	6.5	0.7	610	100	3.9	0.7
∅ 16	1300	310	8.0	1.6	1300	300	8.0	0.8	500	80	4.8	0.8
∅ 17	1220	300	8.5	1.7	1220	285	8.5	0.9	470	75	5.1	0.9
∅ 20	1000	250	10.0	2.0	1000	240	10.0	1.0	400	65	6.0	1.0
∅ 21	980	230	10.5	2.1	980	220	10.5	1.1	380	60	6.3	1.1

절입량  
Depth of Cut

Side Milling

• Ap : Axial Depth

• Ae : Radial Depth

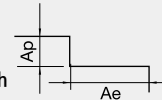

- 유효장 길이가 긴 경우, RPM과 FEED를 동일 비율로 낮춰주세요.
- 열박음 후 완전히 밀착되었는지 확인 후 가공 하십시오.
- 상기 절삭조건은 참고 수치이므로 실 가공시 가공 형상, 가공 목적, 적용 기계에 따라 조건변경 요망 합니다.
- 조건표가 기계의 최대 스피들 속도를 초과하거나 버 및 적열 현상이 발생 시 스피들 속도와 이송 속도를 비례하여 조정하십시오.
- 에어브로, 절삭유, 오일 미스트 콜러트를 추천하며, 칩을 잘 제거하고 가공시 발열과 발화에 주의 하십시오

- If the effective length is long, reduce the RPM and feed in the same proportion.
- After the heat the shrink-fit, check the clamping and bolt status, and then use.
- Use this table for your reference. Adjust the parameters depending on your machining geometry, machining purpose and CNC.
- If the table over the maximum RPM and feed of your machine, or found red heat on the material, adjust RPM and feed in the same proportion.
- Air blow or mist coolants are recommended and note for chip emission, heat, or ignition.

측면절삭 Side Cutting												
피삭재 Material	공구강 / 금형강 Tool steels / Mold steels SCM / HPM				합금강 / 프리하드강 Alloy Steels / Pre-hardened Steels NAK80 / KP4M				고경도강 Hardened Steels STAVAX / SKD11			
경도 Hardness	30 ~ 40Hrc				40 ~ 45Hrc				45 ~ 55Hrc			
외경 Outside Diameter	RPM	FEED	Ap Axial Depth	Ae Radial Depth	RPM	FEED	Ap Axial Depth	Ae Radial Depth	RPM	FEED	Ap Axial Depth	Ae Radial Depth
∅ 10	3075	1150	5.0	1.0	3075	1104	3.0	0.5	1200	299	3.0	0.5
∅ 11	2820	1035	5.5	1.1	2820	966	3.3	0.6	1095	276	3.3	0.6
∅ 12	2580	943	6.0	1.2	2580	874	3.6	0.6	990	230	3.6	0.6
∅ 13	2400	874	6.5	1.3	2400	805	3.9	0.7	915	230	3.9	0.7
∅ 16	1950	713	8.0	1.6	1950	690	4.8	0.8	750	184	4.8	0.8
∅ 17	1830	690	8.5	1.7	1830	656	5.1	0.9	705	173	5.1	0.9
∅ 20	1500	575	10.0	2.0	1500	552	6.0	1.0	600	150	6.0	1.0
∅ 21	1470	529	10.5	2.1	1470	506	6.3	1.1	570	138	6.3	1.1

**절입량**  
Depth of Cut

Side Milling

- Ap : Axial Depth
- Ae : Radial Depth

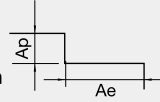

- 유효장 길이가 긴 경우, RPM과 FEED를 동일 비율로 낮춰주세요.
- 열박음 후 완전히 밀착되었는지 확인 후 가공 하십시오.
- 상기 절삭 조건은 6날 기준이며 날 수 증가시 안정적인 속도 내에서 FEED를 UP 해주십시오.
- 상기 절삭 조건은 참고 수치이므로 실 가공시 가공 형상, 가공 목적, 적용 기계에 따라 조건변경 요망 합니다.
- 조건표가 기계의 최대 스피들 속도를 초과하거나 버 및 적열 현상이 발생 시 스피들 속도와 이송 속도를 비례하여 조정 하십시오.
- 에어브로, 절삭유, 오일 미스트 쿨런트를 추천하며, 칩을 잘 제거하고 가공시 발열과 발화에 주의 하십시오
- If the effective length is long, reduce the RPM and feed in the same proportion.
- After the heat the shrink-fit, check the clamping and bolt status, and then use.
- Above the table value is based on 6 flutes. If you use more than 6 flutes of endmill, raise up the feed in stable milling condition.
- Use this table for your reference. Adjust the parameters depending on your machining geometry, machining purpose and CNC.
- If the table over the maximum RPM and feed of your machine, or found red heat on the material, adjust RPM and feed in the same proportion.
- Air blow or mist coolants are recommended and note for chip emission, heat, or ignition.

## 4SFDB

피삭재 Material	흑연 Graphite			
반경 Corner Radius	RPM	FEED	Ap Axial Depth	Ae Radial Depth
R 5	9550	3965	0.250	1.0
R 5.5	8700	3640	0.275	1.1
R 6	7960	3315	0.300	1.2
R 6.5	7350	3055	0.325	1.3
R 8	5970	2470	0.400	1.6
R 8.5	5620	2340	0.850	1.7
R 10	4780	1989	1.000	2.0
R 10.5	4550	1898	1.050	2.1

**절입량**  
Depth of Cut

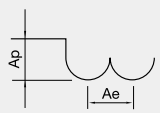

Ap : Axial Depth  
Ae : Radial Depth  
D : Outside Diameter  
n : Speed (min<sup>-1</sup>)  
Vf : Feed (mm/min)

## 4SFDC

피삭재 Material	흑연 Graphite			
외경 Outside Diameter	RPM	FEED	Ap Axial Depth	Ae Radial Depth
∅ 10	5100	4000	0.250	3.0
∅ 11	4630	3700	0.275	3.3
∅ 12	4250	3400	0.300	3.6
∅ 13	3920	3125	0.325	3.9
∅ 16	3180	2550	0.400	4.8
∅ 17	3000	2400	0.850	5.1
∅ 20	2550	2000	1.000	6.0
∅ 21	2430	1950	1.050	6.3

**절입량**  
Depth of Cut

Slotting

- Ap : Axial Depth
- D : Outside Diameter

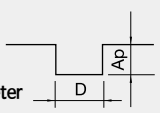

## 6~12SFDC

피삭재 Material	흑연 Graphite			
외경 Outside Diameter	RPM	FEED	Ap Axial Depth	Ae Radial Depth
∅ 10	5100	4840	0.250	3.0
∅ 11	4630	4477	0.275	3.3
∅ 12	4250	4114	0.300	3.6
∅ 13	3920	3781	0.325	3.9
∅ 16	3180	3086	0.400	4.8
∅ 17	3000	2904	0.850	5.1
∅ 20	2550	2420	1.000	6.0
∅ 21	2430	2360	1.050	6.3

**절입량**  
Depth of Cut

Slotting

- Ap : Axial Depth
- D : Outside Diameter

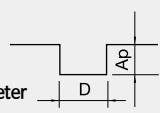

- 유효장 길이가 긴 경우, RPM과 FEED를 동일 비율로 낮춰주세요.
- 열박음 후 완전히 밀착되었는지 확인 후 가공 하십시오.
- 상기 절삭 조건은 참고 수치이므로 실 가공시 가공 형상, 가공 목적, 적용 기계에 따라 조건변경 요망 합니다.
- 조건표가 기계의 최대 스피들 속도를 초과하거나 버 및 적열 현상이 발생 시 스피들 속도와 이송 속도를 비례하여 조정 하십시오.
- 흑연 가공 에어브로를 추천합니다.
- If the effective length is long, reduce the RPM and feed in the same proportion.
- After the heat the shrink-fit, check the clamping and bolt status, and then use.
- Use this table for your reference. Adjust the parameters depending on your machining geometry, machining purpose and CNC.
- If the table over the maximum RPM and feed of your machine, or found red heat on the material, adjust RPM and feed in the same proportion.
- Air blow is recommended for graphite milling.

# PCD End Mill Cutting Condition

• RPM : rev./min • Feed : mm/min

피삭재 Material	VC m/mim	FEED RATE (fz)			
		2 ~ 3mm	4 ~ 6mm	7 ~ 11mm	12 ~ 20mm
AL-alloy Si (1%	150 ~ 6,000	0.007 ~ 0.05	0.02 ~ 0.150	0.02 ~ 0.20	0.04 ~ 0.3
AL-alloy Si (12%	150 ~ 4,000	0.007 ~ 0.05	0.02 ~ 0.150	0.02 ~ 0.20	0.04 ~ 0.3
AL-alloy Si )12%	150 ~ 2,000	0.007 ~ 0.05	0.02 ~ 0.150	0.02 ~ 0.20	0.04 ~ 0.3
Magnesium alloy	150 ~ 6,000	0.007 ~ 0.05	0.02 ~ 0.150	0.02 ~ 0.20	0.04 ~ 0.3
Cooper alloy	150 ~ 5,000	0.007 ~ 0.05	0.02 ~ 0.150	0.02 ~ 0.20	0.04 ~ 0.3
Brass ally	150 ~ 5,001	0.007 ~ 0.05	0.02 ~ 0.150	0.02 ~ 0.20	0.04 ~ 0.3
GFRP	150 ~ 3,000	0.007 ~ 0.05	0.02 ~ 0.150	0.02 ~ 0.20	0.04 ~ 0.3
CFRP	150 ~ 4,000	0.007 ~ 0.05	0.02 ~ 0.150	0.02 ~ 0.20	0.04 ~ 0.3
Graphite	150 ~ 3,000	0.007 ~ 0.05	0.02 ~ 0.150	0.02 ~ 0.20	0.04 ~ 0.3

# 2SPO Cutting Condition

• RPM : rev./min • Feed : mm/min

피삭재 Material	일반구조강/쾌삭강 Mild steels / Free cutting steel HP/SM		구조용강/탄소강/회주철 Structural steels / Carbon Steels /Gray cast irons SS/SC/FC		공구강/금형강 Tool steels / Mold steels SCM/HPM	
	경도 Hardness	~200HB	경도 Hardness	~30HRc	경도 Hardness	30~ 40HRc
외경 Outside Diameter	절삭속도 (V/C)	이송량 (f)	절삭속도 (V/C)	이송량 (f)	절삭속도 (V/C)	이송량 (f)
Ø 1	23,800	500	20,000	400	19,100	380
Ø 2	12,000	700	10,350	400	9,550	380
Ø 3	8,000	800	6,900	550	6,400	510
Ø 4	5,900	800	5,200	620	4,800	570
Ø 6	3,980	700	3,450	550	3,180	510
Ø 8	3,000	600	2,600	520	2,400	480
Ø 10	2,400	580	2,070	500	2,000	460
Ø 12	2,000	560	1,720	480	1,600	450
Ø 16	1,500	500	1,300	400	1,200	380

- 진동이 적고 강성이 좋은 공작기계 사용요망합니다 (Ø1 이하 사용시 진동 허용 관리 3µm이내 일것.)
- 가급적 열박음 척을 추천합니다.
- 상기 절삭 조건은 참고 수치이므로 실 가공시 가공 형상, 가공 목적, 적용 기계에 따라 조건 변경 요망합니다.
- 조건표가 기계의 최대 스피들 속도를 초과하거나 버 및 적열 현상이 발생할 때 스피들 속도와 이송 속도를 비례하여 조정하십시오.
- Use a machine with low vibration and good rigidity (Ø1 or less, the vibration tolerance management should be within 3µm).
- Using shrink-fit chuck is recommended.
- Use this table for your reference. Adjust the parameters depending on your machining geometry, machining purpose and CNC.
- If the table over the maximum RPM and feed of your machine, or found red heat on the material, adjust RPM and feed in the same proportion.

# 2STD Cutting Condition

• RPM : rev./min • Feed : mm/min

피삭재 Material	일반구조강/쾌삭강 Mild Steels/Free cutting steels HP/SM		구조용강/탄소강/회주철 Structural steels / Carbon Steels /Gray cast irons SS/SC/FC		공구강/금형강 Tool steels / Mold steels SCM/HPM		덕타일 주철 Ductile cast irons FCD		스텐레스강 Stainless Steels SUS304/SUS316		알루미늄 합금 Aluminum alloys AL7075		인코넬 Inconel	
	경도 Hardness	~200HB	경도 Hardness	~30HRc	경도 Hardness	30 ~ 40HRc	경도 Hardness		경도 Hardness		경도 Hardness		경도 Hardness	
직경 Diameter	절삭속도 V/C	이송량 f	절삭속도 V/C	이송량 f	절삭속도 V/C	이송량 f	절삭속도 V/C	이송량 f	절삭속도 V/C	이송량 f	절삭속도 V/C	이송량 f	절삭속도 V/C	이송량 f
Ø 3.4	60 ~ 100	0.1 ~ 0.2	60 ~ 100	0.1 ~ 0.2	20 ~ 60	0.05 ~ 0.1	40 ~ 70	0.07 ~ 0.2	20 ~ 60	0.05 ~ 0.2	80 ~ 120	0.1 ~ 0.2	10 ~ 30	0.05 ~ 0.15
Ø 4.3	60 ~ 100	0.1 ~ 0.2	60 ~ 100	0.1 ~ 0.2	20 ~ 60	0.05 ~ 0.1	40 ~ 70	0.07 ~ 0.2	20 ~ 60	0.05 ~ 0.2	80 ~ 120	0.1 ~ 0.2	10 ~ 30	0.05 ~ 0.15
Ø 5.1	60 ~ 100	0.1 ~ 0.2	60 ~ 100	0.1 ~ 0.2	20 ~ 60	0.05 ~ 0.1	40 ~ 70	0.07 ~ 0.2	20 ~ 60	0.05 ~ 0.2	80 ~ 120	0.1 ~ 0.2	10 ~ 30	0.05 ~ 0.15
Ø 6.9	60 ~ 100	0.15 ~ 0.3	60 ~ 100	0.15 ~ 0.3	20 ~ 60	0.08 ~ 0.2	40 ~ 70	0.1 ~ 0.2	20 ~ 60	0.1 ~ 0.2	80 ~ 120	0.15 ~ 0.2	10 ~ 30	0.05 ~ 0.15
Ø 8.6	60 ~ 100	0.15 ~ 0.3	60 ~ 100	0.15 ~ 0.3	20 ~ 60	0.08 ~ 0.2	40 ~ 70	0.1 ~ 0.2	20 ~ 60	0.1 ~ 0.2	80 ~ 120	0.15 ~ 0.2	10 ~ 30	0.05 ~ 0.15
Ø 10.3	60 ~ 100	0.2 ~ 0.4	60 ~ 100	0.2 ~ 0.4	20 ~ 60	0.1 ~ 0.2	40 ~ 70	0.2 ~ 0.4	20 ~ 60	0.15 ~ 0.3	80 ~ 120	0.2 ~ 0.4	10 ~ 30	0.1 ~ 0.2

- 상기 알루미늄 절삭조건은 A7075계열의 기준으로 작성 된 절삭조건으로 그 외에 알루미늄 계열의 드릴링 시 당사 연구소에 문의 바랍니다. (대표번호 02)808-2745 -연구소)
- 진동이 적고 강성이 좋은 공작기계 사용요망합니다 (Ø1 이하 사용시 진동 허용 관리 3µm이내 일것.)
- 가급적 열박음 척을 추천합니다.
- 상기 절삭 조건은 참고 수치이므로 실 가공시 가공 형상, 가공 목적, 적용 기계에 따라 조건 변경 요망합니다.
- 조건표가 기계의 최대 스피들 속도를 초과하거나 버 및 적열 현상이 발생할 때 스피들 속도와 이송 속도를 비례하여 조정하십시오.
- The above aluminum cutting conditions are based on the A7075 series, so please inquire with our staff for drilling conditions for other aluminum series.
- Use a machine with low vibration and good rigidity (Ø1 or less, the vibration tolerance management should be within 3µm).
- Using shrink-fit chuck is recommended.
- Use this table for your reference. Adjust the parameters depending on your machining geometry, machining purpose and CNC.
- If the table over the maximum RPM and feed of your machine, or found red heat on the material, adjust RPM and feed in the same proportion.

## 2DED Cutting Condition

• RPM : rev./min • Feed : mm/min

피삭재 Material	알루미늄 합금 Aluminum alloys AL7075		ABS수지/아크릴 ABS resin / Acrylic	
직경 Diameter	RPM	이송량 (f)	RPM	이송량 (f)
∅ 0.1 ~ 0.3	25,000	0.001 ~ 0.003	22,000	0.001 ~ 0.003
∅ 0.3 ~ 0.5	20,000	0.005 ~ 0.02	22,000	0.005 ~ 0.01
∅ 0.5 ~ 0.8	18,000	0.01 ~ 0.03	15,000	0.01 ~ 0.03
∅ 0.8 ~ 1	15,000	0.02 ~ 0.04	13,000	0.02 ~ 0.05
∅ 1 ~ 1.5	12,000	0.03 ~ 0.05	8,000	0.02 ~ 0.05
∅ 1.5 ~ 2	9,000	0.03 ~ 0.05	6,000	0.02 ~ 0.05
∅ 2 ~ 3	7,000	0.03 ~ 0.05	4,500	0.05
∅ 3 ~ 4	3,500	0.03 ~ 0.05	3,200	0.05
∅ 4 ~ 5	2,800	0.03 ~ 0.05	2,500	0.05
∅ 5 ~ 6	2,200	0.03 ~ 0.05	2,000	0.05

- 상기 알루미늄 절삭조건은 A7075계열의 기준으로 작성 된 절삭조건으로 그 외에 알루미늄 계열의 드릴링 시 당사 연구소에 문의 바랍니다. (대표번호 02)808-2745 -연구소)
- 진동이 적고 강성이 좋은 공작기계 사용요망합니다 (∅1 이하 사용시 진동 허용 관리 3 $\mu$ m이내 일것)
- 급속적 열박음 척을 추천합니다.
- 상기 절삭 조건은 참고 수치이므로 실 가공시 가공 형상, 가공 목적, 적용 기계에 따라 조건 변경 요망합니다.
- 조건표가 기계의 최대 스피들 속도를 초과하거나 버 및 적열 현상이 발생할 때 스피들 속도와 이송 속도를 비례하여 조정하십시오.
- The above aluminum cutting conditions are based on the A7075 series, so please inquire with our staff for drilling conditions for other aluminum series.
- Use a machine with low vibration and good rigidity ( $\varnothing 1$  or less, the vibration tolerance management should be within 3 $\mu$ m).
- Using shrink-fit chuck is recommended.
- Use this table for your reference. Adjust the parameters depending on your machining geometry, machining purpose and CNC.
- If the table over the maximum RPM and feed of your machine, or found red heat on the material, adjust RPM and feed in the same proportion.

## 2MID Cutting Condition

• RPM : rev./min • Feed : mm/min

피삭재 Material	일반구조강/캐삭강 Mild Steels/Free cutting steels HP/SM		구조용강/탄소강/회주철 Structural steels / Carbon Steels /Gray cast irons SS/SC/FC		알루미늄 합금 Aluminum alloys AL7075		동 Copper C1100	
경도 Hardness	~ 200HB		~30HRc		-		-	
외경 Outside Diameter	회전수 RPM	이송 속도 FEED	회전수 RPM	이송 속도 FEED	회전수 RPM	이송 속도 FEED	회전수 RPM	이송 속도 FEED
∅0.5	25,500	510	19,100	380	35,000	700	28,000	350
∅1	191,000	840	13,000	360	28,600	1,720	22,880	860
∅1.5	138,000	760	7,430	330	21,200	1,520	16,960	760
∅2	9,500	630	6,000	330	19,400	1,160	15,520	580
∅2.5	8,900	780	5,730	370	15,300	1,840	12,240	920
∅3	8,500	840	5,900	450	13,000	1,250	10,400	625

- 피삭재의 고정시 불안정 할 시 내구성이 떨어지므로, 확실한 클램핑을 하십시오.
- 원활한 칩 배출을 위해 절삭유 사용을 권장하며, 수용성 절삭유가 효과적입니다.
- 상기 절삭 조건은 참고 수치이므로, 실 가공 시 가공 형상, 가공 목적, 적용 기계에 따라 조건 변경 요망합니다.
- 진동이 적고 강성이 좋은 공작기계 사용 요망합니다. (∅1 이하 사용시 진동 허용 관리 3 $\mu$ m이내일것)
- 조건표가 기계의 최대 스피들 속도를 초과하거나 버 및 적열 현상이 발생할 때 스피들 속도와 이송 속도를 비례하여 조정하십시오.
- Ensure a stable clamping when fixing the cutting tool, as durability may be compromised if the clamping is unstable.
- For smooth chip evacuation, we recommend using cutting oil, and a soluble cutting fluid is effective as well.
- Use this table for your reference. Adjust the parameters depending on your machining geometry, machining purpose and CNC.
- Please use a machine with low vibration and good rigidity (for  $\varnothing 1$  or below, keep vibration tolerance within 3 $\mu$ m).
- If the cutting conditions exceed the maximum spindle speed of the machine or if chattering and thermal phenomena occur, adjust the spindle speed and feed rate proportionally.

# 4DUBE(standard length) Cutting Condition

• RPM : rev./min • Feed : mm/min

피삭재 Material	일반구조강/쾌삭강 Mild Steels/Free cutting steels HP/SM		구조용강/탄소강/회주철 Structural steels / Carbon Steels /Gray cast irons SS/SC/FC		공구강/금형강 Tool steels / Mold steels SCM/HPM		덕타일 주철 Ductile cast irons FCD	
경도 Hardness	~ 200HB		~ 30 HRc		30~40HRc		-	
외경 Outside Diameter	회전수 RPM	이송 속도 FEED	회전수 RPM	이송 속도 FEED	회전수 RPM	이송 속도 FEED	회전수 RPM	이송 속도 FEED
ø6	3,600	920	3,400	575	2,550	600	2,550	580
ø8	2,720	770	2,800	610	1,780	460	1,870	485
ø10	2,150	660	2,120	610	1,440	415	1,530	435
ø12	1,870	630	1,780	550	1,190	370	1,275	400

- 피삭재의 고정 불안정 할 시 내구성이 떨어지므로, 확실한 클램핑을 하십시오.
- 원활한 칩 배출을 위해 절삭유 사용을 권장하며, 수용성 절삭유가 효과적입니다.
- 상기 절삭 조건은 참고 수치이므로, 실 가공 시 가공 형상, 가공 목적, 적용 기계에 따라 조건 변경 요망합니다.
- 절삭하는 피삭재의 따라 구멍길이 최대 5xDc 이상의 드릴링 시 peck(Q) 절입량을 변경하십시오.
- 조건표가 기계의 최대 스핀들 속도를 초과하거나 버 및 적열 현상이 발생할 때 스핀들 속도와 이송 속도를 비례하여 조정하십시오.
- Ensure a stable clamping when fixing the cutting tool, as durability may be compromised if the clamping is unstable.
- For smooth chip evacuation, we recommend using cutting oil, and a soluble cutting fluid is effective as well.
- Use this table for your reference. Adjust the parameters depending on your machining geometry, machining purpose and CNC.
- Please adjust the peck (Q) feed rate when drilling with a cutting tool that has a depth of cut (Dc) exceeding 5 times the diameter.
- If the cutting conditions exceed the maximum spindle speed of the machine or if chattering and thermal phenomena occur, adjust the spindle speed and feed rate proportionally.

# 3DUBEH Cutting Condition

• RPM : rev./min • Feed : mm/min

피삭재 Material	합금강/프리하드강 Alloy Steels / Pre-hardened Steels NAK80 / KP4M		고경도강 Hardened Steels STAVX / SKD11		열처리 / 고경도강 Heat-treated steels / Hardened Steels SKD11 / SKD61		열처리 / 고경도강 Heat-treated steels / Hardened Steels YXR7 / SKH51	
경도 Hardness	40~45HRc		45~55HRc		55~62HRc		62~65HRc	
외경 Outside Diameter	회전수 RPM	이송 속도 FEED	회전수 RPM	이송 속도 FEED	회전수 RPM	이송 속도 FEED	회전수 RPM	이송 속도 FEED
ø3	3,820	232	2,636	127	1,910	86	1452	67
ø4	2,900	235	1,943	130	1,450	72	1088	55
ø5	2,400	211	1,584	119	1,200	66	900	46
ø6	1,910	195	1,320	108	1,000	60	730	36
ø8	1,440	150	965	90	720	45	540	27
ø10	1,177	120	783	72	580	36	435	22
ø12	998	105	653	60	480	30	360	18
ø16	720	75	486	45	360	23	270	14

- 피삭재의 고정 불안정 할 시 내구성이 떨어지므로, 확실한 클램핑을 하십시오.
- 원활한 칩 배출을 위해 절삭유 사용을 권장하며, 수용성 절삭유가 효과적입니다.
- 상기 절삭 조건은 참고 수치이므로, 실 가공 시 가공 형상, 가공 목적, 적용 기계에 따라 조건 변경 요망합니다.
- 상기 절삭 조건은 3Dc이하 조건입니다.
- 3Dc 초과로 절삭 시 스텝 가공을 실시 하십시오. 하지만 절삭 조건에 따라 칩 배출이 나빠질 수 있습니다.
- 조건표가 기계의 최대 스핀들 속도를 초과하거나 버 및 적열 현상이 발생할 때 스핀들 속도와 이송 속도를 비례하여 조정하십시오.
- Ensure a stable clamping when fixing the cutting tool, as durability may be compromised if the clamping is unstable.
- For smooth chip evacuation, we recommend using cutting oil, and a soluble cutting fluid is effective as well.
- The cutting conditions above are 3Dc or less.
- When cutting more than 3Dc, perform step processing. However, depending on the cutting conditions, chip emissions can get worse.
- Please adjust the peck (Q) feed rate when drilling with a cutting tool that has a depth of cut (Dc) exceeding 5 times the diameter.
- If the cutting conditions exceed the maximum spindle speed of the machine or if chattering and thermal phenomena occur, adjust the spindle speed and feed rate proportionally.

## 2DUBES(3XD) Cutting Condition

• RPM : rev./min • Feed : mm/min

피삭재 Material	구조용강/탄소강/회주철 Structural steels / Carbon Steels / Gray cast irons SS / SC / FC		공구강/금형강 Tool Steels / Pre-hardened Steels SCM / HPM		합금강/프리하든강 Alloy Steels / Pre-hardened Steels NAK80 / KP4M		고경도강 Hardened Steels STAVX / SKD11	
경도 Hardness	~30HRc		30~40HRc		40~45HRc		45~55HRc	
외경 Outside Diameter	회전수 RPM	이송 속도 FEED	회전수 RPM	이송 속도 FEED	회전수 RPM	이송 속도 FEED	회전수 RPM	이송 속도 FEED
Ø1	15,900	440	11,000	360	9,450	310	8,900	200
Ø2	7,900	520	6,000	390	5,000	220	4,500	200
Ø3	6,900	770	5,900	450	4,300	250	4,000	230
Ø4	5,170	850	4,500	450	3,200	280	3,000	250
Ø5	4,140	820	3,450	570	3,000	360	2,450	310
Ø6	3,450	840	3,000	570	3,000	330	2,010	310
Ø8	2,580	860	2,100	440	1,700	280	1,520	260
Ø10	2,070	680	1,700	400	1,300	220	1,210	220
Ø12	1,730	560	1,400	350	1,050	200	1,000	200
Ø16	1,300	440	1,150	340	800	170	750	170
Ø20	1,030	390	950	340	650	170	600	170

- 피삭재의 고정미 불안정 할 시 내구성이 떨어지므로, 확실한 클램핑을 하십시오.
- 원활한 칩 배출을 위해 절삭유 사용을 권장하며, 수용성 절삭유가 효과적입니다.
- 상기 절삭 조건은 참고 수치이므로, 실 가공 시 가공 형상, 가공 목적, 적용 기계에 따라 조건 변경 요망합니다.
- 조건표가 기계의 최대 스피들 속도를 초과하거나 버 및 적열 현상이 발생할 때 스피들 속도와 이송 속도를 비례하여 조정하십시오.
- Ensure a stable clamping when fixing the cutting tool, as durability may be compromised if the clamping is unstable.
- For smooth chip evacuation, we recommend using cutting oil, and a soluble cutting fluid is effective as well.
- Use this table for your reference. Adjust the parameters depending on your machining geometry, machining purpose and CNC.
- If the cutting conditions exceed the maximum spindle speed of the machine or if chattering and thermal phenomena occur, adjust the spindle speed and feed rate proportionally.

## 2DUBES(5XD) Cutting Condition

• RPM : rev./min • Feed : mm/min

피삭재 Material	구조용강/탄소강/회주철 Structural steels / Carbon Steels / Gray cast irons SS / SC / FC		공구강/금형강 Tool Steels / Pre-hardened Steels SCM / HPM		합금강/프리하든강 Alloy Steels / Pre-hardened Steels NAK80 / KP4M		고경도강 Hardened Steels STAVX / SKD11	
경도 Hardness	~ 30HRc		30 ~ 40HRc		40 ~ 45HRc		45~55HRc	
외경 Outside Diameter	회전수 RPM	이송 속도 FEED	회전수 RPM	이송 속도 FEED	회전수 RPM	이송 속도 FEED	회전수 RPM	이송 속도 FEED
1mm	15,900	400	11,000	330	9,450	280	8,900	180
2mm	7,900	470	6,000	350	5,000	200	4,500	180
3mm	6,900	700	5,900	410	4,300	230	4,000	210
4mm	5,170	770	4,500	410	3,200	250	3,000	230
5mm	4,140	745	3,450	520	3,000	330	2,450	280
6mm	3,450	760	3,000	520	3,000	300	2,010	280
8mm	2,580	780	2,100	400	1,700	250	1,520	240
10mm	2,070	620	1,700	360	1,300	200	1,210	200
12mm	1,730	510	1,400	320	1,050	180	1,000	180
16mm	1,300	400	1,150	310	800	150	750	150
20mm	1,030	350	950	310	650	150	600	150

- 피삭재의 고정미 불안정 할 시 내구성이 떨어지므로, 확실한 클램핑을 하십시오.
- 원활한 칩 배출을 위해 절삭유 사용을 권장하며, 수용성 절삭유가 효과적입니다.
- 상기 절삭 조건은 참고 수치이므로, 실 가공 시 가공 형상, 가공 목적, 적용 기계에 따라 조건 변경 요망합니다.
- 절삭하는 피삭재의 따라 구멍깊이 최대 5xDc 이상의 드릴링 시 peck(Q) 절입량을 변경하십시오.
- 조건표가 기계의 최대 스피들 속도를 초과하거나 버 및 적열 현상이 발생할 때 스피들 속도와 이송 속도를 비례하여 조정하십시오.
- Ensure a stable clamping when fixing the cutting tool, as durability may be compromised if the clamping is unstable.
- For smooth chip evacuation, we recommend using cutting oil, and a soluble cutting fluid is effective as well.
- Use this table for your reference. Adjust the parameters depending on your machining geometry, machining purpose and CNC.
- Please adjust the peck (Q) feed rate when drilling with a cutting tool that has a depth of cut (Dc) exceeding 5 times the diameter.
- If the cutting conditions exceed the maximum spindle speed of the machine or if chattering and thermal phenomena occur, adjust the spindle speed and feed rate proportionally.



## 2DUBE(short length) Cutting Condition

• RPM : rev./min • Feed : mm/min

피삭재 Material	일반구조강/쾌삭강 Mild Steels/Free cutting steels HP/SM		구조용강/탄소강/회주철 Structural steels / Carbon Steels /Gray cast irons SS/SC/FC		공구강/금형강 Tool steels / Mold steels SCM/HPM		덕타일 주철 Ductile cast irons FCD	
	경도 Hardness	~ 200HB		~ 30HRc		30~40HRc		-
외경 Outside Diameter	회전수 RPM	이송 속도 FEED	회전수 RPM	이송 속도 FEED	회전수 RPM	이송 속도 FEED	회전수 RPM	이송 속도 FEED
ø1	19,100	840	19,200	430	13,000	360	11,500	385
ø2	9,500	630	9,700	430	6,000	330	6,100	330
ø3	8,500	840	8,200	360	5,900	450	5,950	460
ø4	6,400	770	6,500	430	4,500	450	4,400	440
ø5	5,000	940	5,200	680	3,450	550	3,500	560
ø6	4,250	880	4,500	600	4,000	550	3,000	560
ø8	3,200	740	3,300	580	2,100	440	2,200	460
ø10	2,550	640	2,500	580	1,700	400	1,800	420
ø12	2,200	600	2,100	530	1,400	350	1,500	390

- 피삭재의 고정시 불안정 할 시 내구성이 떨어지므로, 확실한 클램핑을 하십시오.
- 원활한 칩 배출을 위해 절삭유 사용을 권장하며, 수용성 절삭유가 효과적입니다.
- 상기 절삭 조건은 참고 수치이므로, 실 가공 시 가공 형상, 가공 목적, 적용 기계에 따라 조건 변경 요망합니다.
- 조건표가 기계의 최대 스핀들 속도를 초과하거나 버 및 적열 현상이 발생할 때 스핀들 속도와 이송 속도를 비례하여 조정하십시오.
- Ensure a stable clamping when fixing the cutting tool, as durability may be compromised if the clamping is unstable.
- For smooth chip evacuation, we recommend using cutting oil, and a soluble cutting fluid is effective as well.
- Use this table for your reference. Adjust the parameters depending on your machining geometry, machining purpose and CNC.
- If the cutting conditions exceed the maximum spindle speed of the machine or if chattering and thermal phenomena occur, adjust the spindle speed and feed rate proportionally.

## 2DUBE(Standard length) Cutting Condition

• RPM : rev./min • Feed : mm/min

피삭재 Material	일반구조강/쾌삭강 Mild Steels/Free cutting steels HP/SM		구조용강/탄소강/회주철 Structural steels / Carbon Steels /Gray cast irons SS/SC/FC		공구강/금형강 Tool steels / Mold steels SCM/HPM		덕타일 주철 Ductile cast irons FCD	
	경도 Hardness	~ 200HB		~ 30HRc		30~40HRc		-
외경 Outside Diameter	회전수 RPM	이송 속도 FEED	회전수 RPM	이송 속도 FEED	회전수 RPM	이송 속도 FEED	회전수 RPM	이송 속도 FEED
ø1	19,100	760	19,200	390	13,000	330	11,500	350
ø2	9,500	570	9,700	390	6,000	300	6,100	300
ø3	8,500	760	8,200	330	5,900	410	5,950	420
ø4	6,400	700	6,500	390	4,500	410	4,400	400
ø5	5,000	850	5,200	620	3,450	520	3,500	510
ø6	4,250	800	4,500	550	4,000	500	3,000	510
ø8	3,200	670	3,300	530	2,100	400	2,200	420
ø10	2,550	850	2,500	530	1,700	360	1,800	380
ø12	2,200	550	2,100	480	1,400	320	1,500	350
ø16	1,600	530	1,600	430	1,150	310	1,100	300
ø20	1,300	450	1,300	430	950	310	900	300

- 피삭재의 고정시 불안정 할 시 내구성이 떨어지므로, 확실한 클램핑을 하십시오.
- 원활한 칩 배출을 위해 절삭유 사용을 권장하며, 수용성 절삭유가 효과적입니다.
- 상기 절삭 조건은 참고 수치이므로, 실 가공 시 가공 형상, 가공 목적, 적용 기계에 따라 조건 변경 요망합니다.
- 절삭하는 피삭재의 따라 구멍깊이 최대 5xDc 이상의 드릴링 시 peck(Q) 절입량을 변경하십시오.
- 조건표가 기계의 최대 스핀들 속도를 초과하거나 버 및 적열 현상이 발생할 때 스핀들 속도와 이송 속도를 비례하여 조정하십시오.
- Ensure a stable clamping when fixing the cutting tool, as durability may be compromised if the clamping is unstable.
- For smooth chip evacuation, we recommend using cutting oil, and a soluble cutting fluid is effective as well.
- Use this table for your reference. Adjust the parameters depending on your machining geometry, machining purpose and CNC.
- Please adjust the peck (Q) feed rate when drilling with a cutting tool that has a depth of cut (Dc) exceeding 5 times the diameter.
- If the cutting conditions exceed the maximum spindle speed of the machine or if chattering and thermal phenomena occur, adjust the spindle speed and feed rate proportionally.

## 2DUBEV(3XD) Cutting Condition

• RPM : rev./min • Feed : mm/min

피삭재 Material	일반구조강/쾌삭강 Mild Steels/Free cutting steels HP/SM		구조용강/탄소강/회주철 Structural steels / Carbon Steels /Gray cast irons SS/SC/FC		공구강/금형강 Tool steels / Mold steels SCM/HPM		덕타일 주철 Ductile cast irons FCD	
경도 Hardness	~ 200HB		~ 30HRc		30~40HRc		-	
외경 Outside Diameter	회전수 RPM	이송 속도 FEED	회전수 RPM	이송 속도 FEED	회전수 RPM	이송 속도 FEED	회전수 RPM	이송 속도 FEED
ø1	19,100	840	19,200	430	13,000	360	11,500	385
ø2	9,500	630	9,700	430	6,000	330	6,100	330
ø3	8,500	840	8,200	360	5,900	450	5,950	460
ø4	6,400	770	6,500	430	4,500	450	4,400	440
ø5	5,000	940	5,200	680	3,450	550	3,500	560
ø6	4,250	880	4,500	600	4,000	550	3,000	560
ø8	3,200	740	3,300	580	2,100	440	2,200	460
ø10	2,550	640	2,500	580	1,700	400	1,800	420
ø12	2,200	600	2,100	530	1,400	350	1,500	390
ø16	1,600	580	1,600	470	1,150	340	1,100	330
ø20	1,300	500	1,300	470	950	340	900	330

- 피삭재의 고정시 불안정 할 시 내구성이 떨어지므로, 확실한 클램핑을 하십시오.
- 원활한 칩 배출을 위해 절삭유 사용을 권장하며, 수용성 절삭유가 효과적입니다.
- 상기 절삭 조건은 참고 수치이므로, 실 가공 시 가공 형상, 가공 목적, 적용 기계에 따라 조건 변경 요망합니다.
- 조건표가 기계의 최대 스피들 속도를 초과하거나 버 및 적열 현상이 발생할 때 스피들 속도와 이송 속도를 비례하여 조정하십시오.
- Ensure a stable clamping when fixing the cutting tool, as durability may be compromised if the clamping is unstable.
- For smooth chip evacuation, we recommend using cutting oil, and a soluble cutting fluid is effective as well.
- Use this table for your reference. Adjust the parameters depending on your machining geometry, machining purpose and CNC.
- If the cutting conditions exceed the maximum spindle speed of the machine or if chattering and thermal phenomena occur, adjust the spindle speed and feed rate proportionally.

## 2DUBEV(5XD) Cutting Condition

• RPM : rev./min • Feed : mm/min

피삭재 Material	일반구조강/쾌삭강 Mild Steels/Free cutting steels HP/SM		구조용강/탄소강/회주철 Structural steels / Carbon Steels /Gray cast irons SS/SC/FC		공구강/금형강 Tool steels / Mold steels SCM/HPM		덕타일 주철 Ductile cast irons FCD	
경도 Hardness	~ 200HB		~ 30HRc		30~40HRc		-	
외경 Outside Diameter	회전수 RPM	이송 속도 FEED	회전수 RPM	이송 속도 FEED	회전수 RPM	이송 속도 FEED	회전수 RPM	이송 속도 FEED
ø1	19,100	760	19,200	390	13,000	330	11,500	350
ø2	9,500	570	9,700	390	6,000	300	6,100	300
ø3	8,500	760	8,200	330	5,900	410	5,950	420
ø4	6,400	700	6,500	390	4,500	410	4,400	400
ø5	5,000	850	5,200	620	3,450	500	3,500	510
ø6	4,250	800	4,500	550	4,000	500	3,000	510
ø8	3,200	670	3,300	530	2,100	400	2,200	420
ø10	2,550	580	2,500	530	1,700	360	1,800	380
ø12	2,200	550	2,100	480	1,400	320	1,500	350
ø16	1,600	430	1,600	530	1,150	310	1,100	300
ø20	1,300	450	1,300	430	950	310	900	300

- 피삭재의 고정시 불안정 할 시 내구성이 떨어지므로, 확실한 클램핑을 하십시오.
- 원활한 칩 배출을 위해 절삭유 사용을 권장하며, 수용성 절삭유가 효과적입니다.
- 상기 절삭 조건은 참고 수치이므로, 실 가공 시 가공 형상, 가공 목적, 적용 기계에 따라 조건 변경 요망합니다.
- 절삭하는 피삭재의 따라 구멍깊이 최대 5xDc 이상의 드릴링 시 peck(Q) 절입량을 변경하십시오.
- 조건표가 기계의 최대 스피들 속도를 초과하거나 버 및 적열 현상이 발생할 때 스피들 속도와 이송 속도를 비례하여 조정하십시오.
- Ensure a stable clamping when fixing the cutting tool, as durability may be compromised if the clamping is unstable.
- For smooth chip evacuation, we recommend using cutting oil, and a soluble cutting fluid is effective as well.
- Use this table for your reference. Adjust the parameters depending on your machining geometry, machining purpose and CNC.
- Please adjust the peck (Q) feed rate when drilling with a cutting tool that has a depth of cut (Dc) exceeding 5 times the diameter.
- If the cutting conditions exceed the maximum spindle speed of the machine or if chattering and thermal phenomena occur, adjust the spindle speed and feed rate proportionally.

# 2DUBEW(3XD) Cutting Condition

• RPM : rev./min • Feed : mm/min

피삭재 Material	일반구조강/쾌삭강 Mild Steels/Free cutting steels HP/SM		구조용강/탄소강/회주철 Structural steels / Carbon Steels /Gray cast irons SS/SC/FC		덕타일 주철 Ductile cast irons FCD		스테인레스강 Stainless Steels SUS304/SUS316	
경도 Hardness	~200HB		~30Hrc		-		-	
외경 Outside Diameter	회전수 RPM	이송 속도 FEED	회전수 RPM	이송 속도 FEED	회전수 RPM	이송 속도 FEED	회전수 RPM	이송 속도 FEED
ø1	19,000	530	13,200	430	13,200	460	19,150	830
ø2	9,480	620	7,200	460	7,010	400	9,550	630
ø3	8,280	920	7,080	540	6,840	550	8,400	830
ø4	6,200	1010	5,400	540	5,060	550	6,350	770
ø5	4,970	980	4,140	690	4,025	670	5,100	715
ø6	4,140	1000	3,600	690	3,450	670	4,200	660
ø8	3,100	1030	2,520	530	2,530	550	3,200	740
ø10	2,500	830	2,040	470	2,070	500	2,550	700
ø12	2,100	670	1,680	420	1,725	460	2,100	580
ø16	1,560	530	1,380	410	1,265	400	1,600	510
ø20	1,240	460	1,140	410	1,035	400	1,250	480

- 피삭재의 고정 불안정 할 시 내구성이 떨어지므로, 확실한 클램핑을 하십시오.
- 원활한 칩 배출을 위해 절삭유 사용을 권장하며, 수용성 절삭유가 효과적입니다.
- 상기 절삭 조건은 참고 수치이므로, 실 가공 시 가공 형상, 가공 목적, 적용 기계에 따라 조건 변경 요망합니다.
- Peck(Q) drilling 간격은 외부 쿨런트 타입 0.2Dc~0.5Dc, 내부 쿨런트 타입 0.2Dc~1.5Dc를 권장합니다.
- 조건표가 기계의 최대 스피들 속도를 초과하거나 버 및 적열 현상이 발생할 때 스피들 속도와 이송 속도를 비례하여 조정하십시오.
- Ensure a stable clamping when fixing the cutting tool, as durability may be compromised if the clamping is unstable.
- For smooth chip evacuation, we recommend using cutting oil, and a soluble cutting fluid is effective as well.
- Use this table for your reference. Adjust the parameters depending on your machining geometry, machining purpose and CNC.
- For peck (Q) drilling, we recommend intervals of 0.2Dc to 0.5Dc for external coolant types and 0.2Dc to 1.5Dc for internal coolant types.
- If the cutting conditions exceed the maximum spindle speed of the machine or if chattering and thermal phenomena occur, adjust the spindle speed and feed rate proportionally.

# 2DUBEW(5XD) Cutting Condition

• RPM : rev./min • Feed : mm/min

피삭재 Material	일반구조강/쾌삭강 Mild Steels/Free cutting steels HP/SM		구조용강/탄소강/회주철 Structural steels / Carbon Steels /Gray cast irons SS/SC/FC		덕타일 주철 Ductile cast irons FCD		스테인레스강 Stainless Steels SUS304/SUS316	
경도 Hardness	~200HB		~30Hrc		-		-	
외경 Outside Diameter	회전수 RPM	이송 속도 FEED	회전수 RPM	이송 속도 FEED	회전수 RPM	이송 속도 FEED	회전수 RPM	이송 속도 FEED
ø1	19,000	480	13,200	390	13,200	420	19,150	750
ø2	9,480	560	7,200	420	7,010	360	9,550	570
ø3	8,280	840	7,080	490	6,840	500	8,400	750
ø4	6,200	920	5,400	490	5,060	500	6,350	700
ø5	4,970	890	4,140	625	4,025	610	5,100	650
ø6	4,140	910	3,600	625	3,450	610	4,200	600
ø8	3,100	940	2,520	480	2,530	500	3,200	670
ø10	2,500	750	2,040	430	2,070	455	2,550	640
ø12	2,100	610	1,680	380	1,725	420	2,100	525
ø16	1,560	480	1,380	370	1,265	360	1,600	460
ø20	1,240	420	1,140	370	1,035	360	1,250	440

- 피삭재의 고정 불안정 할 시 내구성이 떨어지므로, 확실한 클램핑을 하십시오.
- 원활한 칩 배출을 위해 절삭유 사용을 권장하며, 수용성 절삭유가 효과적입니다.
- 상기 절삭 조건은 참고 수치이므로, 실 가공 시 가공 형상, 가공 목적, 적용 기계에 따라 조건 변경 요망합니다.
- 절삭하는 피삭재의 따라 구멍깊이 최대 5xDc 이상의 드릴링 시 peck(Q) 절입량을 변경하십시오.
- Peck(Q) drilling 간격은 외부 쿨런트 타입 0.2Dc~0.5Dc, 내부 쿨런트 타입 0.2Dc~1.5Dc를 권장합니다.
- 조건표가 기계의 최대 스피들 속도를 초과하거나 버 및 적열 현상이 발생할 때 스피들 속도와 이송 속도를 비례하여 조정하십시오.
- Ensure a stable clamping when fixing the cutting tool, as durability may be compromised if the clamping is unstable.
- For smooth chip evacuation, we recommend using cutting oil, and a soluble cutting fluid is effective as well.
- Use this table for your reference. Adjust the parameters depending on your machining geometry, machining purpose and CNC.
- Please adjust the peck (Q) feed rate when drilling with a cutting tool that has a depth of cut (Dc) exceeding 5 times the diameter.
- For peck (Q) drilling, we recommend intervals of 0.2Dc to 0.5Dc for external coolant types and 0.2Dc to 1.5Dc for internal coolant types.
- If the cutting conditions exceed the maximum spindle speed of the machine or if chattering and thermal phenomena occur, adjust the spindle speed and feed rate proportionally.

## 2DUBEN(3XD) Cutting Condition

• RPM : rev./min • Feed : mm/min

피삭재 Material	알루미늄 합금 주물 Aluminum alloy castings AC48		알루미늄 합금 Aluminum alloy AL7075		ABS수지/아크릴 ABS resin / Acrylic	
	외경 Outside Diameter	회전수 RPM	이송 속도 FEED	회전수 RPM	이송 속도 FEED	회전수 RPM
∅1	28,600	1,720	25,740	1,540	10,500	210
∅2	19,400	1,160	17,460	1,050	7,000	210
∅3	13,000	1,250	11,700	1,120	5,250	260
∅4	9,650	1,160	8,685	1,040	3,850	190
∅5	7,800	1,120	7,020	1,010	2,850	140
∅6	6,500	840	5,850	760	2,250	110
∅8	4,850	870	4,365	790	1,800	90
∅10	3,900	800	3,510	720	1,450	70
∅12	3,200	770	2,880	700	1,200	60
∅13	3,000	800	2,700	710	1,100	55

- 피삭재의 고정시 불안정 할 시 내구성이 떨어지므로, 확실한 클램핑을 하십시오.
- 원활한 칩 배출을 위해 절삭유 사용을 권장하며, 수용성 절삭유가 효과적입니다.
- 상기 절삭 조건은 참고 수치이므로, 실 가공 시 가공 형상, 가공 목적, 적용 기계에 따라 조건 변경 요망합니다.
- 절삭하는 피삭재의 따라 구멍깊이 최대 5xDc 이상의 드릴링 시 peck(Q) 절입량을 변경하십시오.
- 진동이 적고 강성이 좋은 공작기계 사용 요망합니다. (∅1 이하 사용 시 진동 허용 관리 3μm 이내일것)
- 조건표가 기계의 최대 스피들 속도를 초과하거나 버 및 적열 현상이 발생할 때 스피들 속도와 이송 속도를 비례하여 조정하십시오.
- Ensure a stable clamping when fixing the cutting tool, as durability may be compromised if the clamping is unstable.
- For smooth chip evacuation, we recommend using cutting oil, and a soluble cutting fluid is effective as well.
- Use this table for your reference. Adjust the parameters depending on your machining geometry, machining purpose and CNC.
- Please adjust the peck (Q) feed rate when drilling with a cutting tool that has a depth of cut (Dc) exceeding 5 times the diameter.
- Please use a machine with low vibration and good rigidity (for ∅1 or below, keep vibration tolerance within 3μm).
- If the cutting conditions exceed the maximum spindle speed of the machine or if chattering and thermal phenomena occur, adjust the spindle speed and feed rate proportionally.

## 2DUBEN(5XD) Cutting Condition

• RPM : rev./min • Feed : mm/min

피삭재 Material	알루미늄 합금 주물 Aluminum alloy castings AC48		알루미늄 합금 Aluminum alloy AL7075		ABS수지/아크릴 ABS resin / Acrylic	
	외경 Outside Diameter	회전수 RPM	이송 속도 FEED	회전수 RPM	이송 속도 FEED	회전수 RPM
∅1	28,600	1,430	25,740	1,290	10,500	168
∅2	19,400	970	17,460	870	7,000	168
∅3	13,000	1,040	11,700	940	5,250	208
∅4	9,650	970	8,685	870	3,850	152
∅5	7,800	940	7,020	850	2,850	112
∅6	6,500	700	5,850	630	2,250	88
∅8	4,850	730	4,365	660	1,800	72
∅10	3,900	660	3,510	600	1,450	56
∅12	3,200	640	2,880	580	1,200	48
∅13	3,000	660	2,700	600	1,100	44

- 피삭재의 고정시 불안정 할 시 내구성이 떨어지므로, 확실한 클램핑을 하십시오.
- 원활한 칩 배출을 위해 절삭유 사용을 권장하며, 수용성 절삭유가 효과적입니다.
- 상기 절삭 조건은 참고 수치이므로, 실 가공 시 가공 형상, 가공 목적, 적용 기계에 따라 조건 변경 요망합니다.
- 절삭하는 피삭재의 따라 구멍깊이 최대 5xDc 이상의 드릴링 시 peck(Q) 절입량을 변경하십시오.
- 진동이 적고 강성이 좋은 공작기계 사용 요망합니다. (∅1 이하 사용 시 진동 허용 관리 3μm 이내일것)
- 조건표가 기계의 최대 스피들 속도를 초과하거나 버 및 적열 현상이 발생할 때 스피들 속도와 이송 속도를 비례하여 조정하십시오.
- Ensure a stable clamping when fixing the cutting tool, as durability may be compromised if the clamping is unstable.
- For smooth chip evacuation, we recommend using cutting oil, and a soluble cutting fluid is effective as well.
- Use this table for your reference. Adjust the parameters depending on your machining geometry, machining purpose and CNC.
- Please adjust the peck (Q) feed rate when drilling with a cutting tool that has a depth of cut (Dc) exceeding 5 times the diameter.
- Please use a machine with low vibration and good rigidity (for ∅1 or below, keep vibration tolerance within 3μm).
- If the cutting conditions exceed the maximum spindle speed of the machine or if chattering and thermal phenomena occur, adjust the spindle speed and feed rate proportionally.

# 2FDR Cutting Condition

• RPM : rev./min • Feed : mm/min

피삭재 Material	일반구조강/패삭강 Mild Steels/Free cutting steels HP/SM		구조용강/탄소강/회주철 Structural steels / Carbon Steels /Gray cast irons SS/SC/FC		공구강/금형강 Tool Steels / Mold steels SCM/HPM		합금강/프리하든강 Alloy Steels / Pre-hardened Steels NAK80/KP4M		덕타일 주철 Ductile cast irons FCD		스테인레스강 Stainless Steels SUS304/SUS316	
	경도Hardness	~200HB		~30HRc		30 ~ 40HRc		40 ~ 45HRc		-		-
외경 Diameter	회전수 RPM	이송속도 FEED	회전수 RPM	이송속도 FEED	회전수 RPM	이송속도 FEED	회전수 RPM	이송속도 FEED	회전수 RPM	이송속도 FEED	회전수 RPM	이송속도 FEED
Ø 0.2	33000	35	29500	40	16500	25	14000	15	29500	30	16200	15
Ø 0.3	31500	55	25000	40	15500	30	12500	15	26500	35	15300	15
Ø 0.4	27500	75	23800	50	14500	35	11500	20	23200	40	14500	20
Ø 0.5	25800	85	22000	60	13200	40	11000	25	21500	45	13200	20
Ø 0.6	24600	115	20500	85	12000	55	10000	25	20000	60	12000	25
Ø 0.7	22500	135	19500	115	11000	70	9000	30	18500	90	11500	30
Ø 0.8	21000	180	18000	150	10500	80	8000	35	17000	120	10000	35
Ø 0.9	20500	240	16800	190	9500	95	7500	35	16000	145	9850	40
Ø 1	19500	300	16000	230	9450	110	6800	35	15700	180	9600	50
Ø 2	12000	340	10000	290	5800	150	4100	60	10000	230	-	-
Ø 3	8000	410	7100	330	3800	165	2700	70	7100	280	-	-
Ø 4	6100	425	5200	380	2700	170	2100	80	5250	300	-	-
Ø 5	4900	425	4200	280	2350	175	1650	80	4250	300	-	-
Ø 6	4150	425	3550	330	1800	175	1350	80	3550	300	-	-
Ø 8	3100	430	2700	350	1500	175	1000	80	2700	300	-	-
Ø 10	2600	430	2200	360	1100	175	850	80	2000	300	-	-
Ø 12	2100	430	1750	360	950	175	630	80	1800	310	-	-
Ø 18	1600	430	1400	360	750	175	520	80	1350	310	-	-
Ø 20	1250	430	1100	360	600	175	430	80	1000	310	-	-

- 절삭 조건표 참조는 수용성 절삭유 사용이 전제입니다. 절삭유를 사용하지 않을 시, 회전과 속도를 20% 줄여 사용하십시오.
- 절삭하는 피삭재에 따라 드릴링의 최종깊이가 직경대비 2배 이상 시 펙 드릴링 방식을 권장합니다.
- 경사 드릴 가공시, 경사진 각도에 따라(절삭 조건을) 조절하십시오. 경사각이 30도 이하일 때, 피드를 50% 낮추십시오. 경사각이 30도 이상일 때, 회전을 70% 이하, 피드를 30% 이하로 줄이십시오.
- 측면 가공용으로는 사용하지 마십시오.
- 절삭 조건을 기계 강성이나 클램프 상태에 따라 조절하십시오.
- Use the water soluble cutting oil. In case if you do not use water soluble cutting oil, reduce the RPM and the feed by 20%.
- When the final depth of drilling exceeds twice the diameter relative to the cutting material, we recommend using peck drilling method.
- For stainless drilling, we recommend that the tool diameter is 1.9mm or less.
- If you use for inclined angle as slope drilling, reduce the feed by 50% for inclined angle less than 30°, and reduce below 70% of the RPM and 30% of the feed for inclined angle over 30°.
- Do not use for side milling.
- Change cutting conditions depending on work variables: rigidity of machine, work clamp or material shape.

# 2FDR Cutting Condition

• RPM : rev./min • Feed : mm/min

피삭재 Material	일반구조강/패삭강 Mild Steels/Free cutting steels HP/SM		구조용강/탄소강/회주철 Structural steels / Carbon Steels /Gray cast irons SS/SC/FC		공구강/금형강 Tool Steels / Mold steels SCM/HPM		합금강/프리하든강 Alloy Steels / Pre-hardened Steels NAK80/KP4M		덕타일 주철 FCD	
	경도Hardness	~200HB		~30HRc		30 ~ 40HRc		40 ~ 45HRc		-
외경 Diameter	회전수 RPM	이송속도 FEED	회전수 RPM	이송속도 FEED	회전수 RPM	이송속도 FEED	회전수 RPM	이송속도 FEED	회전수 RPM	이송속도 FEED
Ø 3	11000	800	9500	580	7500	320	5000	220	9300	400
Ø 4	8000	800	7200	580	5600	320	4100	220	7300	400
Ø 5	6500	800	5550	580	4500	320	3300	220	6000	400
Ø 6	5500	810	4800	590	3550	320	2700	220	5000	400
Ø 8	4100	810	3600	590	2850	320	2000	220	3800	400
Ø 10	3300	810	3000	590	2350	320	1650	220	3000	410
Ø 12	2750	820	2450	600	2000	320	1480	220	2480	410
Ø 16	2100	820	1800	600	1550	330	1000	220	1850	410
Ø 20	1650	820	1550	600	1250	330	850	220	1550	410

- 절삭 조건표 참조는 수용성 절삭유 사용이 전제입니다. 절삭유를 사용하지 않을 시, 회전과 이송속도를 20% 줄여 사용하십시오.
- 절삭하는 피삭재에 따라 드릴링의 최종깊이가 직경대비 2배 이상 시 펙 드릴링 방식을 권장합니다.
- 측면 가공용으로는 사용하지 마십시오.
- 절삭 조건을 기계 강성이나 클램프 상태에 따라 조절하십시오.
- Use the water soluble cutting oil. In case if you do not use water soluble cutting oil, reduce the RPM and the feed by 20%.
- When the final depth of drilling exceeds twice the diameter relative to the cutting material, we recommend using peck drilling method.
- Do not use for stainless material. We recommend using 2FDRW or 2FDRWLW for stainless material.
- Do not use for side milling.
- Change cutting conditions depending on work variables: rigidity of machine, work clamp or material shape.

# 2FDRW Cutting Condition

• RPM : rev./min • Feed : mm/min

피삭재 Material	일반구조강/쾌삭강 Mild Steels/Free cutting steels HP/SM		구조용강/탄소강/회주철 Structural steels / Carbon Steels /Gray cast irons SS/SC/FC		공구강/금형강 Tool Steels / Mold steels SCM/HPM		합금강/프리하든강 Alloy Steels / Pre-hardened Steels NAK80/KP4M		덕타일 주철 Ductile cast irons FCD		스테인레스강 Stainless Steels SUS304/SUS316	
경도 Hardness	~200HB		~30HRc		30 ~ 40HRc		40 ~ 45HRc		-		-	
외경 Diameter	회전수 RPM	이송 속도 FEED	회전수 RPM	이송 속도 FEED	회전수 RPM	이송 속도 FEED	회전수 RPM	이송 속도 FEED	회전수 RPM	이송 속도 FEED	회전수 RPM	이송 속도 FEED
Ø3	12500	900	10000	600	7500	300	6500	270	10000	450	10000	600
Ø4	9500	930	8000	620	5500	300	4800	270	8000	450	8000	600
Ø5	7500	930	6500	620	4500	300	3800	270	6300	460	6300	620
Ø6	6500	950	5400	630	3700	330	3200	280	5400	470	5500	620
Ø8	4800	950	4000	630	2900	330	2500	280	4000	470	4000	620
Ø10	3800	950	3300	630	2450	330	2000	280	3200	470	3300	620
Ø12	3300	950	2800	630	2000	330	1600	280	2800	470	2900	620
Ø16	2500	950	2000	630	1500	330	1300	280	2000	470	2000	620

- 절삭 조건표 참조는 수용성 절삭유 사용이 전제입니다. 절삭유를 사용하지 않을 시, 회전과 속도를 20% 줄여 사용하십시오.
- 드릴 깊이는 3xDc를 넘기지 마십시오. 칩 배출 상태가 좋지 않을 경우, 펙드릴링 방식을 사용하십시오.
- 펙드릴 간격은 0.1Dc ~ 0.5Dc 사이를 권장합니다.
- 측면 가공용으로는 사용하지 마십시오.
- 절삭 조건을 기계 강성이나 클램프 상태에 따라 조절하십시오.
- Use the water soluble cutting oil. In case if you do not use water soluble cutting oil, reduce the RPM and the feed by 20%.
- Do not over the drilling depth of 3 x Dc. If the state of chip emission is not good enough, use peck drilling method.
- For the stainless material, use peck drilling method.
- Peck drill interval is recommended between 0.1 Dc to 0.5 Dc.
- Side milling is not possible.
- Change cutting conditions depending on work variables: rigidity of machine, work clamp or material shape.

# 2FDRWL Cutting Condition

• RPM : rev./min • Feed : mm/min

피삭재 Material	일반구조강/쾌삭강 Mild Steels/Free cutting steels HP/SM		구조용강/탄소강/회주철 Structural steels / Carbon Steels /Gray cast irons SS/SC/FC		공구강/금형강 Tool Steels / Mold steels SCM/HPM		합금강/프리하든강 Alloy Steels / Pre-hardened Steels NAK80/KP4M		덕타일 주철 Ductile cast irons FCD		스테인레스강 Stainless Steels SUS304/SUS316	
경도 Hardness	~200HB		~30HRc		30 ~ 40HRc		40 ~ 45HRc		-		-	
외경 Diameter	회전수 RPM	이송 속도 FEED	회전수 RPM	이송 속도 FEED	회전수 RPM	이송 속도 FEED	회전수 RPM	이송 속도 FEED	회전수 RPM	이송 속도 FEED	회전수 RPM	이송 속도 FEED
Ø3	15000	1250	10000	600	7300	300	6500	270	10000	460	10000	600
Ø4	11000	1300	8000	600	5500	300	4800	270	8000	460	8000	620
Ø5	9000	1300	6400	600	4500	300	3800	270	6500	460	6500	620
Ø6	7500	1350	5300	630	3700	320	3200	280	5300	480	5300	630
Ø8	5600	1350	4000	630	2800	320	2500	280	4000	480	4000	630
Ø10	4500	1350	3200	630	2300	320	2000	280	3200	480	3300	630
Ø12	3700	1350	2800	630	2000	320	1700	280	2900	480	2800	630
Ø16	2850	1350	2100	630	1500	320	1300	280	2100	480	2100	630

- 절삭 조건표 참조는 수용성 절삭유 사용이 전제입니다. 절삭유를 사용하지 않을 시, 회전과 속도를 20% 줄여 사용하십시오.
- 드릴 깊이는 5xDc를 넘기지 마십시오. 칩 배출 상태가 좋지 않을 경우, 펙드릴링 방식을 사용하십시오.
- 펙드릴 간격은 0.1Dc ~ 0.5Dc 사이를 권장합니다.
- 측면 가공용으로는 사용하지 마십시오.
- 절삭 조건을 기계 강성이나 클램프 상태에 따라 조절하십시오.
- Use the water soluble cutting oil. In case if you do not use water soluble cutting oil, reduce the RPM and the feed by 20%.
- Do not over the drilling depth of 5 x Dc. If the state of chip emission is not good enough, use peck drilling method.
- For the stainless material, use peck drilling method.
- Peck drill interval is recommended between 0.1 Dc to 0.5 Dc.
- Side milling is not possible.
- Change cutting conditions depending on work variables: rigidity of machine, work clamp or material shape.

# 추천 절삭조건표

## Recommended Cutting Conditions

### 4ETM(R)

피삭재 Work Material	알루미늄 합금 Aluminum alloys AL7075		스테인레스강 Stainless steels SUS304 / SUS316		구조용강/탄소강/회주철 Structural steels / Carbon Steels /Gray cast irons SS/SC/FC		합금강/프리하든강 Alloy Steels / Pre-hardened Steels NAK80/KP4M	
경도 Hardness					~30HRc		40 ~ 45HRc	
TAP	V/C	FZ	V/C	FZ	V/C	FZ	V/C	FZ
M3	120~250	0.02 ~ 0.03	70 ~ 80	0.01 ~ 0.015	60 ~ 70	0.01 ~ 0.015	45 ~ 55	0.005 ~ 0.01
M4		0.02 ~ 0.03		0.01 ~ 0.015		0.01 ~ 0.015		0.005 ~ 0.01
M5		0.02 ~ 0.03		0.01 ~ 0.015		0.01 ~ 0.015		0.005 ~ 0.01
M6		0.03 ~ 0.04		0.015 ~ 0.02		0.015 ~ 0.02		0.01 ~ 0.015
M8		0.03 ~ 0.04		0.015 ~ 0.02		0.015 ~ 0.02		0.01 ~ 0.015
M10		0.04 ~ 0.05		0.015 ~ 0.02		0.015 ~ 0.02		0.015 ~ 0.02
M12		0.04 ~ 0.05		0.015 ~ 0.02		0.015 ~ 0.02		0.015 ~ 0.02
M16~M23		0.05 ~ 0.07		0.025 ~ 0.03		0.025 ~ 0.03		0.015 ~ 0.02

### 2DTM

피삭재 Work Material	알루미늄 합금 Aluminum alloys AL7075		비철금속 Non-ferrous metal	
	V/C	FZ	V/C	FZ
M3	200~250	0.03 ~ 0.04	250~300	0.03 ~ 0.04
M4		0.03 ~ 0.04		0.03 ~ 0.04
M5		0.03 ~ 0.04		0.03 ~ 0.04
M6		0.04 ~ 0.05		0.04 ~ 0.05
M8		0.04 ~ 0.05		0.04 ~ 0.05
M10		0.05 ~ 0.06		0.05 ~ 0.06
M12		0.06 ~ 0.07		0.06 ~ 0.07
M16		0.06 ~ 0.07		0.06 ~ 0.07

### 4IMTM

피삭재 Work Material	티타늄 합금 Titanium Alloys	
TAP	V/C	FZ
M0.8 ~ M1	20 ~ 60	0.005 ~ 0.01
M1 ~ M2		0.005 ~ 0.01
M 2.5		0.005 ~ 0.01
M 2.6		0.005 ~ 0.01

### 4TRTM(S)

피삭재 Work Material	스테인레스강 Stainless steels SUS304 / SUS316		일반구조강 / 쾌삭강 Mild Steels / Free cutting steels HP / SM		구조용강/탄소강/회주철 Structural steels / Carbon Steels /Gray cast irons SS/SC/FC		공구강 / 금형강 Tool steels / Mold steels SCM / HPM	
경도 Hardness			~200HB		~30HRc		30 ~ 40HRc	
TAP	V/C	FZ	V/C	FZ	V/C	FZ	V/C	FZ
Tr8, Tr9	70 ~ 80	0.02 ~ 0.03	60 ~ 70	0.02 ~ 0.03	50 ~ 60	0.01 ~ 0.02	40 ~ 50	0.01 ~ 0.02
Tr10, Tr11		0.02 ~ 0.03		0.02 ~ 0.03		0.01 ~ 0.02		0.01 ~ 0.02
Tr12, Tr14		0.03 ~ 0.04		0.03 ~ 0.04		0.02 ~ 0.03		0.02 ~ 0.03
Tr12		0.03 ~ 0.04		0.03 ~ 0.04		0.02 ~ 0.03		0.02 ~ 0.03
Tr14, Tr22		0.03 ~ 0.04		0.03 ~ 0.04		0.02 ~ 0.03		0.02 ~ 0.03
Tr16, Tr18, Tr20		0.03 ~ 0.04		0.03 ~ 0.04		0.02 ~ 0.03		0.02 ~ 0.03
Tr22, Tr24, Tr26		0.03 ~ 0.04		0.03 ~ 0.04		0.02 ~ 0.03		0.02 ~ 0.03

- 파지력이 좋은 열박음 척 사용을 추천 합니다.
- 떨림방지를 위한 부등분할 설계로, 공구 진입 시 f1 (mm/tooth) 기준으로 나사가공 이송대비 50% 수준으로 낮춰 주십시오.
- 상기 절삭조건은 참고 수치이므로 실 가공시 가공 형상, 가공 목적, 적용 기계에 따라 조건변경 요망 합니다.
- 절삭시 내,외부 급유형 쿨런트 사용을 추천합니다.
- Using shrink-fit chuck with great holding power is recommended.
- When the tool approaches the work material, reduce the feed by 50%.
- Use this table for your reference. Adjust the parameters depending on your machining geometry, machining purpose and CNC.
- Internal and external coolants are recommended for milling.

# 추천 절삭조건표 Recommended Cutting Conditions

## 4MTM

피삭재 Work Material	알루미늄 합금 Aluminum alloys AL7075		스테인레스강 Stainless steels SUS304 / SUS316		합금강 / 프리하든강 Alloy Steels / Pre-hardened Steels NAK80 / KP4M		열처리 / 고경도강 Heat-treated steels / Hardened Steels SKD11 / SKD61	
경도 Hardness					40 ~ 45HRc		55 ~ 62HRc	
TAP	V/C	FZ	V/C	FZ	V/C	FZ	V/C	FZ
M1	120 ~ 250	0.03 ~ 0.04	70 ~ 85	0.01 ~ 0.02	50 ~ 60	0.01 ~ 0.02	40 ~ 50	0.008 ~ 0.01
M2		0.03 ~ 0.04		0.01 ~ 0.02		0.01 ~ 0.02		0.008 ~ 0.01
M3		0.03 ~ 0.04		0.01 ~ 0.02		0.01 ~ 0.02		0.01 ~ 0.02
M4		0.04 ~ 0.05		0.02 ~ 0.03		0.01 ~ 0.02		0.01 ~ 0.02
M6		0.04 ~ 0.05		0.02 ~ 0.03		0.02 ~ 0.03		0.02 ~ 0.03
M8		0.05 ~ 0.06		0.03 ~ 0.04		0.02 ~ 0.03		0.02 ~ 0.03
M10		0.06 ~ 0.07		0.05 ~ 0.06		0.02 ~ 0.03		0.02 ~ 0.03
M12		0.06 ~ 0.07		0.05 ~ 0.06		0.03 ~ 0.04		0.03 ~ 0.04

## 4BSP(T)

피삭재 Work Material	알루미늄 합금 Aluminum alloys AL7075		스테인레스강 Stainless steels SUS304 / SUS316		합금강 / 프리하든강 Alloy Steels / Pre-hardened Steels NAK80 / KP4M		열처리 / 고경도강 Heat-treated steels / Hardened Steels SKD11 / SKD61	
경도 Hardness					40 ~ 45HRc		55 ~ 58HRc	
TAP	V/C	FZ	V/C	FZ	V/C	FZ	V/C	FZ
1/16/28C	120 ~ 250	0.04 ~ 0.05	70 ~ 85	0.02 ~ 0.03	50 ~ 60	0.02 ~ 0.03	40 ~ 50	0.02 ~ 0.03
1/4/19C		0.05 ~ 0.06		0.03 ~ 0.04		0.02 ~ 0.03		0.02 ~ 0.03
1/2/14C		0.06 ~ 0.07		0.05 ~ 0.06		0.02 ~ 0.03		0.02 ~ 0.03
1"/11C		0.06 ~ 0.07		0.05 ~ 0.06		0.03 ~ 0.04		0.03 ~ 0.04

## 4HBSP

피삭재 Work Material	알루미늄 합금 Aluminum alloys AL7075		스테인레스강 Stainless steels SUS304 / SUS316		구조용강/탄소강/회주철 Structural steels / Carbon Steels / Gray cast irons SS/SC/FC		합금강 / 프리하든강 Alloy Steels / Pre-hardened Steels NAK80 / KP4M	
경도 Hardness					~ 30 HRc		40 ~ 45HRc	
TAP	V/C	FZ	V/C	FZ	V/C	FZ	V/C	FZ
1/16/28C	120 ~ 150	0.03 ~ 0.04	70 ~ 85	0.02 ~ 0.03	50 ~ 65	0.01 ~ 0.02	40 ~ 50	0.01 ~ 0.02
1/4/19C		0.03 ~ 0.04		0.02 ~ 0.03		0.01 ~ 0.02		0.01 ~ 0.02
1/2/14C		0.05 ~ 0.06		0.03 ~ 0.04		0.02 ~ 0.03		0.02 ~ 0.03
1"/11C		0.05 ~ 0.06		0.03 ~ 0.04		0.02 ~ 0.03		0.02 ~ 0.03

- 파지력이 좋은 열박음 척 사용을 추천 합니다.
- 떨림방지를 위한 부등분할 설계로, 공구 진입 시 f1 (mm/tooth) 기준으로 나사가공 이송대비 50% 수준으로 낮춰 주십시오.
- 상기 절삭조건은 참고 수치이므로, 실 가공시 가공 형상, 가공 목적, 적용 기계에 따라 조건변경 요망 합니다.
- 절삭시 내,외부 급유형 쿨런트 사용을 추천합니다.
- Using shrink-fit chuck with great holding power is recommended.
- When the tool approaches the work material, reduce the feed by 50%.
- Use this table for your reference. Adjust the parameters depending on your machining geometry, machining purpose and CNC.
- Internal and external coolants are recommended for milling.



# 추천 절삭조건표

## Recommended Cutting Conditions

### 4STM

피삭재 Work Material	알루미늄 합금 Aluminum alloys AL7075		스테인레스강 Stainless steels SUS304 / SUS316		합금강 / 프리하든강 Alloy Steels / Pre-hardened Steels NAK80 / KP4M		열처리 / 고경도강 Heat-treated steels / Hardened Steels SKD11 / SKD61	
경도 Hardness					40 ~ 45HRc		55 ~ 62HRc	
TAP	V/C	FZ	V/C	FZ	V/C	FZ	V/C	FZ
M1 ~ m3	120 ~ 250	0.03 ~ 0.04	70 ~ 85	0.01 ~ 0.02	50 ~ 60	0.01 ~ 0.02	40 ~ 50	0.008 ~ 0.01
M4		0.03 ~ 0.04		0.01 ~ 0.02		0.01 ~ 0.02		0.008 ~ 0.01
M5		0.03 ~ 0.04		0.01 ~ 0.02		0.01 ~ 0.02		0.01 ~ 0.02
M6		0.04 ~ 0.05		0.02 ~ 0.03		0.01 ~ 0.02		0.01 ~ 0.02
M8		0.04 ~ 0.05		0.02 ~ 0.03		0.02 ~ 0.03		0.02 ~ 0.03
M10		0.05 ~ 0.06		0.03 ~ 0.04		0.02 ~ 0.03		0.02 ~ 0.03
M12		0.06 ~ 0.07		0.05 ~ 0.06		0.02 ~ 0.03		0.02 ~ 0.03
M16 ~ M20		0.06 ~ 0.07		0.05 ~ 0.06		0.03 ~ 0.04		0.03 ~ 0.04

### 4HTM/4LTM

피삭재 Work Material	알루미늄 합금 Aluminum alloys AL7075		스테인레스강 Stainless steels SUS304 / SUS316		합금강 / 프리하든강 Alloy Steels / Pre-hardened Steels NAK80 / KP4M		열처리 / 고경도강 Heat-treated steels / Hardened Steels SKD11 / SKD61	
경도 Hardness					~ 30HRC		40 ~ 45HRC	
TAP	V/C	FZ	V/C	FZ	V/C	FZ	V/C	FZ
M3	120 ~ 150	0.02 ~ 0.03	70 ~ 85	0.01 ~ 0.02	50 ~ 65	0.01 ~ 0.02	40 ~ 50	0.008 ~ 0.01
M4		0.02 ~ 0.03		0.01 ~ 0.02		0.01 ~ 0.02		0.008 ~ 0.01
M5		0.02 ~ 0.03		0.01 ~ 0.02		0.01 ~ 0.02		0.01 ~ 0.02
M6		0.03 ~ 0.04		0.02 ~ 0.03		0.01 ~ 0.02		0.01 ~ 0.02
M8		0.03 ~ 0.04		0.02 ~ 0.03		0.01 ~ 0.02		0.02 ~ 0.03
M10		0.05 ~ 0.06		0.03 ~ 0.04		0.02 ~ 0.03		0.02 ~ 0.03
M12		0.05 ~ 0.06		0.03 ~ 0.04		0.02 ~ 0.03		0.02 ~ 0.03
M16 ~ M20		0.05 ~ 0.06		0.03 ~ 0.04		0.02 ~ 0.03		0.02 ~ 0.03

### 4NKTM

피삭재 Work Material	알루미늄 합금 Aluminum alloys AL7075		스테인레스강 Stainless steels SUS304 / SUS316		합금강 / 프리하든강 Alloy Steels / Pre-hardened Steels NAK80 / KP4M		열처리 / 고경도강 Heat-treated steels / Hardened Steels SKD11 / SKD61	
경도 Hardness					40 ~ 45HRc		55 ~ 62HRc	
TAP	V/C	FZ	V/C	FZ	V/C	FZ	V/C	FZ
M3	120 ~ 150	0.03 ~ 0.04	70 ~ 85	0.01 ~ 0.02	50 ~ 65	0.01 ~ 0.02	40 ~ 55	0.008 ~ 0.01
M4		0.03 ~ 0.04		0.01 ~ 0.02		0.01 ~ 0.02		0.008 ~ 0.01
M5		0.03 ~ 0.04		0.01 ~ 0.02		0.01 ~ 0.02		0.01 ~ 0.02
M6		0.04 ~ 0.05		0.02 ~ 0.03		0.01 ~ 0.02		0.01 ~ 0.02
M8		0.04 ~ 0.05		0.02 ~ 0.03		0.02 ~ 0.03		0.02 ~ 0.03
M10		0.05 ~ 0.06		0.03 ~ 0.04		0.02 ~ 0.03		0.02 ~ 0.03
M12		0.06 ~ 0.07		0.05 ~ 0.06		0.02 ~ 0.03		0.02 ~ 0.03
M16		0.06 ~ 0.07		0.05 ~ 0.06		0.03 ~ 0.04		0.03 ~ 0.04
M20		0.06 ~ 0.07		0.05 ~ 0.06		0.03 ~ 0.04		0.03 ~ 0.04

# 추천 절삭조건표

## Recommended Cutting Conditions

### 4BSTM

피삭재 Work Material	알루미늄 합금 Aluminum alloys AL7075		스테인레스강 Stainless steels SUS304 / SUS316		구조용강/탄소강/회주철 Structural steels / Carbon Steels / Gray cast irons SS/SC/FC		합금강 / 프리하든강 Alloy Steels / Pre-hardened Steels NAK80 / KP4M	
경도 Hardness					~30HRc		40~45HRc	
TAP	V/C	FZ	V/C	FZ	V/C	FZ	V/C	FZ
1/16.28C BSPT	120 ~ 150	0.03 ~ 0.04	70 ~ 85	0.02 ~ 0.03	50 ~ 65	0.01 ~ 0.02	40 ~ 50	0.01 ~ 0.02
1/8.28C BSPT		0.03 ~ 0.04		0.02 ~ 0.03		0.01 ~ 0.02		0.01 ~ 0.02
1/4.19C BSPT		0.05 ~ 0.06		0.03 ~ 0.04		0.02 ~ 0.03		0.02 ~ 0.03
3/8.19C BSPT		0.05 ~ 0.06		0.03 ~ 0.04		0.02 ~ 0.03		0.02 ~ 0.03
1/2(3/4).14C BSPT		0.05 ~ 0.06		0.03 ~ 0.04		0.02 ~ 0.03		0.02 ~ 0.03
1".11C BSPT		0.05 ~ 0.06		0.03 ~ 0.04		0.02 ~ 0.03		0.02 ~ 0.03

### 4NPTS

피삭재 Work Material	알루미늄 합금 Aluminum alloys AL7075		스테인레스강 Stainless steels SUS304 / SUS316		합금강 / 프리하든강 Alloy Steels / Pre-hardened Steels NAK80 / KP4M		열처리 / 고경도강 Heat-treated steels / Hardened Steels SKD11 / SKD61	
경도 Hardness					40 ~ 45HRc		55 ~ 62HRc	
TAP	V/C	FZ	V/C	FZ	V/C	FZ	V/C	FZ
1/16/27C	120 ~ 250	0.04 ~ 0.05	70 ~ 85	0.02 ~ 0.03	50 ~ 60	0.02 ~ 0.03	40 ~ 50	0.02 ~ 0.03
1/4/18C		0.05 ~ 0.06		0.03 ~ 0.04		0.02 ~ 0.03		0.02 ~ 0.03
1/2/14C		0.06 ~ 0.07		0.05 ~ 0.06		0.02 ~ 0.03		0.02 ~ 0.03
1"/11.5C		0.06 ~ 0.07		0.05 ~ 0.06		0.03 ~ 0.04		0.03 ~ 0.04

### 4NPTM

피삭재 Work Material	알루미늄 합금 Aluminum alloys AL7075		스테인레스강 Stainless steels SUS304 / SUS316		구조용강/탄소강/회주철 Structural steels / Carbon Steels / Gray cast irons SS/SC/FC		합금강 / 프리하든강 Alloy Steels / Pre-hardened Steels NAK80 / KP4M	
경도 Hardness					~30HRc		40 ~ 45HRc	
TAP	V/C	FZ	V/C	FZ	V/C	FZ	V/C	FZ
1/16.27C NPT	120 ~ 150	0.03 ~ 0.04	70 ~ 85	0.02 ~ 0.03	50 ~ 85	0.01 ~ 0.02	40 ~ 50	0.01 ~ 0.02
1/8.27C NPT		0.03 ~ 0.04		0.02 ~ 0.03		0.01 ~ 0.02		0.01 ~ 0.02
1/4.18C NPT		0.05 ~ 0.06		0.03 ~ 0.04		0.02 ~ 0.03		0.02 ~ 0.03
3/8.18C NPT		0.05 ~ 0.06		0.03 ~ 0.04		0.02 ~ 0.03		0.02 ~ 0.03
1/2(3/4).14C NPT		0.05 ~ 0.06		0.03 ~ 0.04		0.02 ~ 0.03		0.02 ~ 0.03

#### 절삭조건 계산공식

$$\text{회전수 (N)} : N = 1000 \times V / \pi \times D$$

V : 절삭속도  
 $\pi$  : 3.14 (원주율)  
 D : 공구직경

$$\text{분당이송} : F = f \times Z \times N$$

f : 회전당 이송  
 Z : 날 수  
 N : 회전 수

- 절삭하는 피삭재에 따라 절입 횟수를 변경하십시오. (열처리 강 나사 가공 시 3회 이상의 절입을 권장합니다.)
- 나사플러그 게이지 측정 후 경 보정값을 수정하십시오.
- 긴 유효장 타입의 제품을 사용 시 나사가공 이송속도를 줄여주십시오.
- 가급적 열박음 척을 추천 합니다.
- 공구 진입 시 이송 f(mm/tooth)을 나사가공 이송 대비 30% 수준으로 낮추주십시오.
- 상기 절삭조건은 참고 수치입니다. 실 가공시 가공 형상, 가공 목적, 적용 기계에 따라 조건변경 요망합니다.

- Change the number of feeds according to the workpiece material. (Three or more feeds are recommended for thread milling of hardened steel.)
- Modify the diameter correction value after measuring the gauge of screw plug.
- When using the tool with long effective length, please reduce the speed of threading feed. Shrink fit chuck is recommended.
- During the approach of the tool to the workpiece, please reduce the feed F value (mm/tooth) to 30% of the feed for threading.
- The above cutting condition is just for reference.
- You may modify depending on the processing shape, purpose of processing, and the machine you use.

# 엔드밀 재연삭 가격 안내

## 초경 Ball & Radius 엔드밀

• 부등분할 : × 1.5 • C작업시 : × 0.9

날경		6이하	10이하	12이하	16이하	20이하	25이하
무코팅	2날	6,100	6,600	7,700	9,900	13,200	16,500
	3, 4, 6날	8,300	9,400	11,000	12,100	16,500	22,000
TISIN코팅	2날	8,300	9,500	10,900	13,400	19,100	20,900
	3, 4, 6날	10,300	12,500	13,400	15,200	23,800	26,400

## 초경 엔드밀 절단 & 밀날

• 부등분할 : × 1.1 • 라핑시 : × 1.1

날경		6이하	10이하	12이하	16이하	20이하	25이하
무코팅	2날	4,200	4,800	6,400	8,500	10,700	13,900
	3, 4, 6날	5,300	5,900	7,500	10,700	12,300	17,100
TISIN코팅	2날	4,800	5,200	7,100	10,100	12,400	15,200
	3, 4, 6날	5,800	6,300	8,500	12,400	13,800	18,200

## 초경 다이아 절단 & 밀날

날경		6이하	10이하	12이하	16이하	20이하	25이하
2날		9,500	10,750	14,500	19,250	24,250	31,500
3, 4, 6날		12,000	13,250	17,000	24,250	27,750	38,750

## 초경 Taper 엔드밀 외경연삭

• 30도 미만 제작수리 : × 2  
• 30도 이상 제작수리 : × 1.5

생크경 (∅)	6이하	8이하	10이하	12이하	16이하	20이하	25이하	32이하
2°미만	10,900	12,100	13,400	14,600	18,200	24,200	30,300	36,300
2°이상	10,900	12,100	14,600	17,000	21,800	29,100	33,900	38,800
30°이상	7,300	8,500	9,700	10,900	13,400	18,200	23,000	30,300

## HSS Taper 엔드밀

• Long : × 1.5 • 제작수리 : × 2 • 역 : × 2

생크경 (∅)	16이하	20이하	25이하	32이하	35이하
2°미만	8,500	9,700	10,900	14,600	18,200
2°이상	9,700	12,100	14,600	18,200	21,800
30°이상	7,300	8,500	9,700	12,100	14,600

## 초경 엔드밀 외경연삭

• Long : × 1.2 • EX.Long : × 1.5

날경	6이하	12이하	16이하	20이하	25이하	30이하
2날	4,900	6,100	8,500	12,100	18,200	25,500
4날	6,100	7,300	9,700	14,600	21,800	30,300

• 골수리(홈연삭) : × 2

## HSS 엔드밀 외경연삭

• Long : × 1.5 • EX.Long : × 2

날경	20이하	30이하	40이하	50이하
2날	3,700	4,900	8,500	14,600
4날	4,900	6,100	9,700	18,200

• 골수리(홈연삭) : × 1.5

## 초경 High Helix 엔드밀 외경연삭

• Long : × 1.2 • EX.Long : × 1.5

날경	6이하	12이하	16이하	20이하	25이하	32이하
4날	11,000	13,200	16,500	19,800	30,800	36,300
6날	12,100	14,600	18,200	21,800	33,900	40,000

• 골수리(홈연삭) : × 2

## HSS Roughing 엔드밀

• Long : × 1.5 • EX.Long : × 2

날경	20이하	30이하	40이하	50이하
-	4,900	6,100	8,500	10,900

## 날붙이(BG) 초경 엔드밀 외경연삭

• Long : × 1.5 • EX.Long : × 2

날경	20이하	30이하	40이하	50이하
2날	6,100	9,700	12,100	18,200
4날	7,300	10,900	14,600	24,200

• 골수리(홈연삭) : × 2

## HITACHI Ball & Radius 인서트

R × D	R6 X12,13	R8 X16,17	R10 X20,21	R12.5X25,26	R15 X30
무코팅	6,600	7,700	8,800	9,900	13,200
TIALN코팅	11,000	13,200	14,300	15,400	18,700

## 초경 엔드밀 TISIN 코팅 가격

• Long : × 1.5 (전장 150L 이상)

날경	6이하	8이하	10이하	12이하	16이하	20이하	25이하	32이하
-	2,100	2,600	3,500	4,700	8,800	10,500	15,200	21,100

## 초경 엔드밀 JJ 코팅 가격

• Long : × 1.5 (전장 150L 이상)

날경	6이하	8이하	10이하	12이하	16이하	20이하	25이하	32이하
-	2,500	3,100	4,200	5,600	10,500	12,700	18,300	25,400

## 초경 드릴 재연마

오일홀 타입 × 1.8

날경	6이하	10이하	12이하	16이하	20이하
무코팅 2날	5,500	6,000	7,000	9,000	12,000
TIALN코팅 2날	7,500	8,500	10,000	12,000	17,000

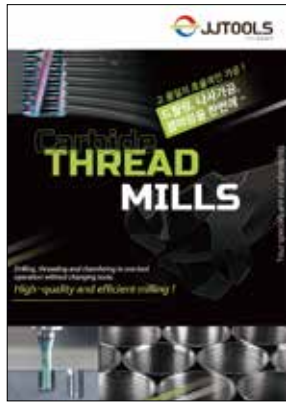

# Your specials are our standards. 당신의 스페셜은 우리의 표준품입니다.

WWW.JJTOOLS.CO.KR

### 공구 사용시 주의사항

- 공구가 사용중 파손되어 상해의 위험이 있으므로 보호안경 등 안전장비를 착용하고 사용해 주십시오
- 공구의 목적 외에 다른 용도로 사용하거나 전용장비가 아닌 장비에 장착하지 마시고 임의로 연삭, 변경하지 마십시오
- 제품 날부분의 손상을 방지하기 위해 가능한 비접촉 측정을 권고합니다.
- 공구의 체결이 정확히 되었는지 확인한 후 사용해 주십시오.
- 사용시 고열로 인한 스파크가 발생할 수 있습니다.
- 화재나 폭발 등 위험 인자를 제거하고 사용하십시오
- 제품 사용 전과 후에도 공구와 가공물의 치수를 반드시 확인해 주십시오
- 공구가 마모되거나 손상된 경우 사용을 중지해 주십시오
- 비정상적인 진동, 소음이 발생할 경우 시스템을 중지하고 진동, 소음의 원인을 확인하여 제거 하십시오.

### Precautions When Using Tools

- Wear safety equipment such as protective eyewear to prevent the risk of injury in case the tool breaks during use.
- Do not use the tool for purposes other than its intended use, or install it on equipment that is not designed for it. Do not grind or modify it arbitrarily.
- To prevent damage to the cutting edge, it is recommended to use non-contact measurements whenever possible.
- Ensure proper attachment of the tool before use.
- Sparks may be generated due to high heat during use.
- Eliminate potential fire or explosion hazards before using.
- Before and after use, always check the dimensions of the tool and the workpiece.
- Discontinue use if the tool is worn or damaged.
- If abnormal vibration or noise occurs, stop the system and identify and eliminate the cause of the vibration or noise.



31, Dusan-ro, Geumcheon-gu, Seoul,  
Republic of Korea Tel. +82.2.808.2745  
Fax. +82.2.808.2746 www.jjtools.co.kr



제이제이툴스의 전제품은 세계적인 품질. 환경 규격인 ISO 품질·환경 경영시스템 인증을 획득하였습니다.

ISO 9001/ISO 14001